



# GaAs SPDT Switch

## DC- 3.0 GHz

V 1.00

SW-438

### Features

- Low Insertion Loss, 0.7 dB @ 2.4 GHz<sup>1</sup>
  - High Isolation, 25 dB @ 2.4 GHz<sup>1</sup>
  - Low Power Consumption, < 10  $\mu$ A @ +3 V
  - Low Cost Plastic SOT-363 Package
1. For best results at 2.4 GHz, use 8 pF 0402 profile SMT capacitors on RF ports and 100 pF bypassing on pins 4 and 6.

### Description

The SW-438 is a GaAs MMIC SPDT switch in a low cost SOT-363 surface mount plastic package. Typical applications include transmit/receive switching for Bluetooth and WLAN equipment. The SW-438 can also be used in applications up to 500 mW in systems such as cellular, PCS, DCS1800, GSM, CDMA and other analog and digital wireless communications systems.

M/A-COM fabricates the SW-438 using a 0.5 micron gate length GaAs p-HEMT process. The process features full passivation for increased performance and reliability.

### External Component Requirements

Please note the values of the external capacitors. The capacitors at each of the RF ports are used as for achieving optimum insertion loss. They also provide DC blocking for positive control. The 8 pF (0402) capacitor is recommended for 2 - 3 GHz operation. If this value is changed or the capacitor placed too far from the switch, the performance will be affected. We also recommend 100 pF bypass capacitors on pins 4 and 6.

For broadband applications with positive control voltages, use DC blocking capacitors with value of 39 pF or more.

### Truth Table

Mode (Control)	V1	V2	RFC-RF1	RFC-RF2
Positive <sup>1</sup>	0 $\pm$ 0.2V +2.3 to +5V	+2.3 to +5V 0 $\pm$ 0.2V	Off On	On Off
Negative <sup>2</sup>	0 $\pm$ 0.2V -2.3 to +5V	-2.3 to +5V 0 $\pm$ 0.2V	On Off	Off On

1. External DC blocking capacitors are required on all RF ports.
2. If negative control is used, DC blocking capacitors are not required on RF ports.

### Functional Schematic

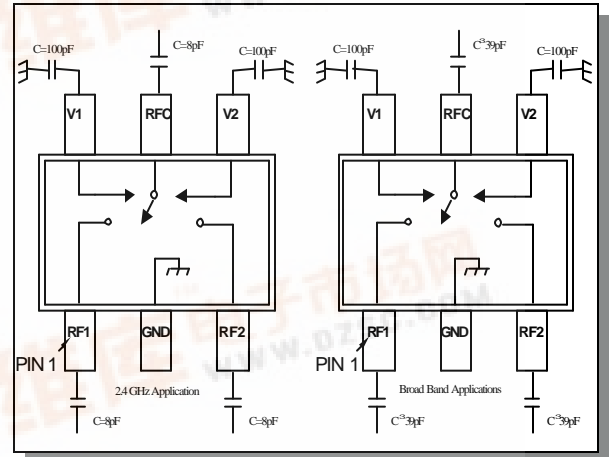

### Pin Configuration

Pin No.	Function	Description
1	RF1	RF Input/Output
2	GND	RF Ground
3	RF2	RF Input/Output
4	V2	Control 2 Input
5	RFC	RF Common Port
6	V1	Control 1 Input

### Ordering Information

Part Number	Package
SW-438TR-3000	SW-438 on 13 Inch, 3000 piece Reel
SW-438SMB	SW-438 sample test board



Electrical Specifications:  $T_A = 25^\circ\text{C}$ , 3V Control

Parameter	Test Conditions	Units	Min	Typ	Max
Insertion Loss	DC-3.0 GHz	dB		0.7	0.8
Isolation	DC-1.0 GHz	dB	29	31	
	1.0-2.0 GHz	dB	23	25	
	2.0-3.0 GHz	dB	21	23	
Return Loss	DC-1.5 GHz	dB	18	22	
	1.5-3.0 GHz	dB	16	20	
P1dB (2.3 V supply)	500 MHz-2.0 GHz	dBm	23	26	
P1dB (3V supply)	500 MHz-2.0 GHz	dBm	28	31	
IP2	2-tone 900 MHz, 5 MHz spacing (2.3V)	dBm		81	
IP3	2-tone 900 MHz, 5 MHz spacing (2.3V)	dBm		55	
2 <sup>nd</sup> Harmonic	2.4 GHz Pin = 20 dBm, Vc = 2.3V	dBc		70	
3 <sup>rd</sup> Harmonic	2.4 GHz Pin = 20 dBm, Vc = 2.3V	dBc		60	
Ton, Toff	50% ctl to 10/90% RF	ns		20	
Trise, Tfall	10% to 90% RF	ns		10	
Gate Leakage	Vctl  = 5V	$\mu\text{A}$		5	10

## Typical Performance Curves

## Bluetooth Applications

(8 pF DC Blocking Capacitors, +2.3V Control)

Insertion Loss vs. Frequency Over Temperature

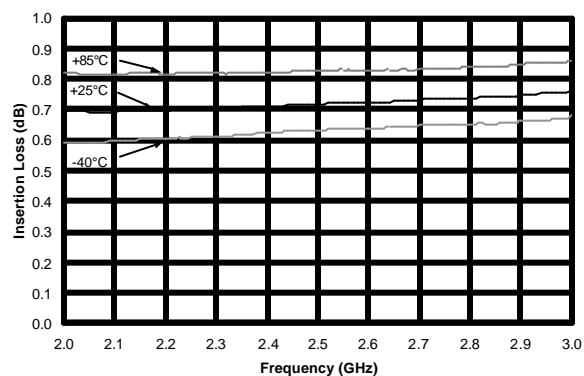

Isolation vs. Frequency Over Temperature

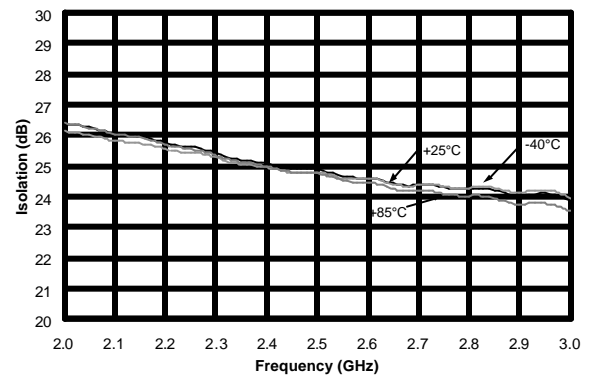

Specifications subject to change without notice.

- North America: Tel. (800) 366-2266
- Asia/Pacific: Tel.+81-44-844-8296, Fax +81-44-844-8298
- Europe: Tel. +44 (1344) 869 595, Fax+44 (1344) 300 020

*Return Loss vs. Frequency Over Temperature*

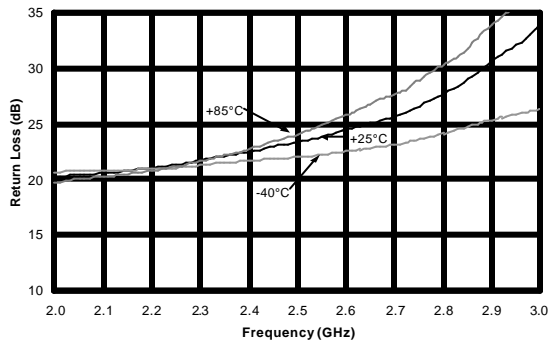

**Broadband Applications  
(No DC Blocking Capacitors, -2.3 V Control)**

*Insertion Loss vs. Frequency Over Temperature*

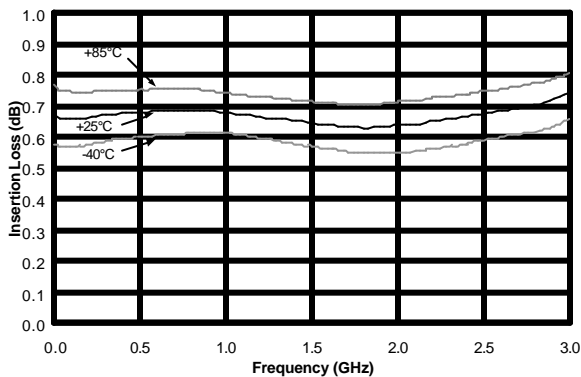

*Isolation vs. Frequency Over Temperature*

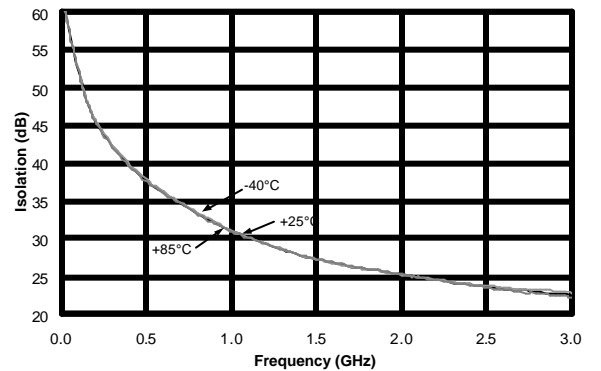

*Return Loss vs. Frequency Over Temperature*

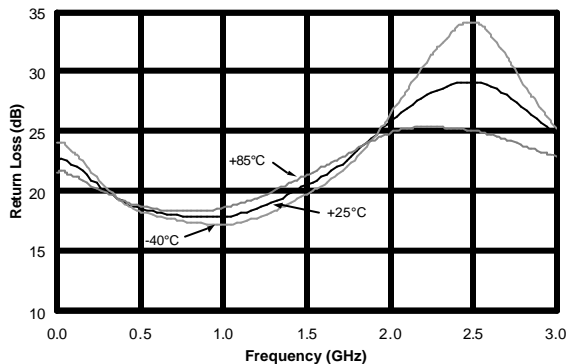

Specifications subject to change without notice.

- North America: Tel. (800) 366-2266
- Asia/Pacific: Tel.+81-44-844-8296, Fax +81-44-844-8298
- Europe: Tel. +44 (1344) 869 595, Fax+44 (1344) 300 020

**SOT-363 (SC-70) Plastic Package**

Dimension	Measurement (mm)		
	Min.	Nom.	Max.
A	—	—	1.10
A1	0	—	0.10
A2	0.70	0.90	1.00
b	0.15	—	0.30
c	0.08	—	0.22
D		2.00 basic	
e		0.65 basic	
E		2.10 basic	
E1		1.25 basic	
L		0.42 ref.	

Note: See JEDEC MO-203 VAR AB for Additional dimensions and tolerances.

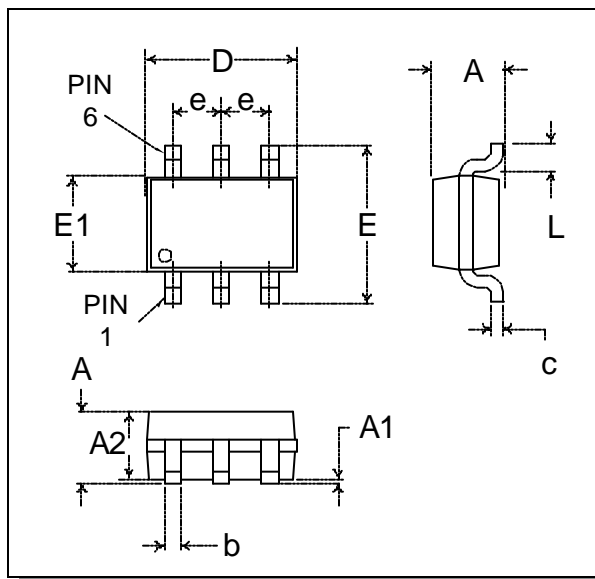

Specifications subject to change without notice.

- North America: Tel. (800) 366-2266
- Asia/Pacific: Tel.+81-44-844-8296, Fax +81-44-844-8298
- Europe: Tel. +44 (1344) 869 595, Fax+44 (1344) 300 020