



GaAs SPDT Switch

0.05 - 3.0 GHz

SW-485

Features

- Low Insertion Loss 0.3 dB Typ. @ 2.4 GHz
- Moderate Isolation 21 dB @ 2.4 GHz
- Low Power Consumption <5 μ A @ +2.3V
- Low Cost Plastic SOT-363 Package

Description

M/A-COM's SW-485 is a GaAs PHEMT MMIC SPDT switch in a low cost SC-70 (SOT-363) surface mount plastic package. The SW-485 is ideally suited for applications where very small size and low cost are required. Typical applications are dual band systems where switching between small signal components is required such as filter banks, single-band LNAs, converters, etc. This part can be used for low power, low loss requirements in the all systems operating up to 3 GHz, including PCS, GSM, DCS, Blue Tooth, and other Rx chain applications.

The SW-485 is fabricated using a 0.5 micron gate length GaAs PHEMT process. The process features full passivation for performance and reliability.

Handling Procedures

The following precautions should be observed to avoid damage:

Static Sensitivity

Gallium Arsenide Integrated Circuits are ESD sensitive and can be damaged by static electricity. Proper ESD techniques should be used when handling these devices.

Absolute Maximum Ratings ¹

Parameter	Absolute Maximum
Max Input Power (0.5 - 3.0 GHz)	
3 V Control	+32 dBm
5 V Control	+34 dBm
Operating Voltage	+8.5 volts
Operating Temperature	-40 °C to +85 °C
Storage Temperature	-65 °C to +150 °C

1. Exceeding any one or combination of these limits may cause permanent damage.

Functional Schematic

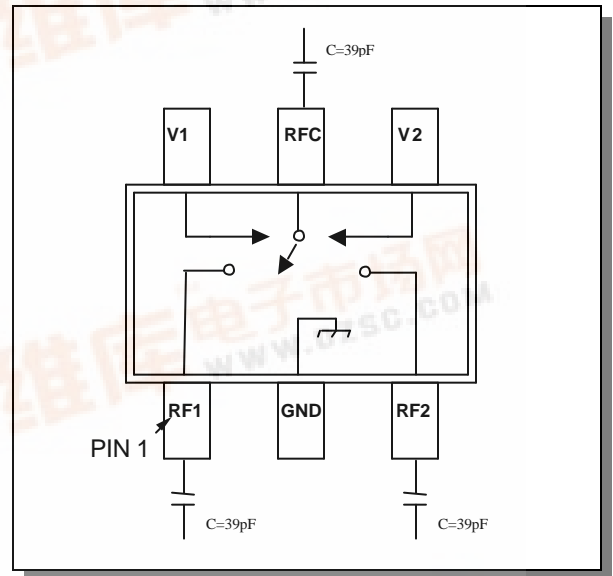

Pin Configuration

Pin No.	Function	Description
1	RF1	RF Port 1
2	GND	Ground
3	RF2	RF Port 2
4	V2	Control 2
5	RFC	RF Input
6	V1	Control 1

Truth Table ²

Mode (Control)	Control V1	Control V2	RFC-RF1	RFC-RF2
Positive ¹	0 \pm 0.2V +2.3 to +5V	+2.3 to +5V 0 \pm 0.2V	On Off	Off On

2. External DC blocking capacitors are required on all RF ports.



Electrical Specifications: $T_A = 25^\circ\text{C}$, $Z_0 = 50 \Omega$ ³

Parameter	Test Conditions	Units	Min	Typ	Max
Insertion Loss	0.05-1.0 GHz	dB		0.25	0.4
	0.05-3.0 GHz	dB		0.35	0.55
Isolation	0.05-1.0 GHz	dB	20	23	
	0.05-3.0 GHz	dB	20	21	
VSWR	0.05-3.0 GHz	dB		1.1:1	1.2:1
IP2	Two Tone +5 dBm, 5 MHz Spacing, >50 MHz	dBm		90	
IP3	Two Tone +5 dBm, 5 MHz Spacing, >50 MHz	dBm		46	
P1dB	$V_c = 0.2\text{V}/2.5\text{V}$	dBm		21	
	$V_c = 0.2\text{V}/3.0\text{V}$	dBm		25	
Trise, Tfall	10% to 90% RF and 90% to 10% RF	nS		35	
Ton, Toff		nS		40	
Transients		mV		10	

3. Insertion Loss can be optimized by varying the DC Blocking Capacitor value, i.e. 1000 pF for 100 MHz—1GHz, 39 pF for 0.5 GHz—3 GHz.

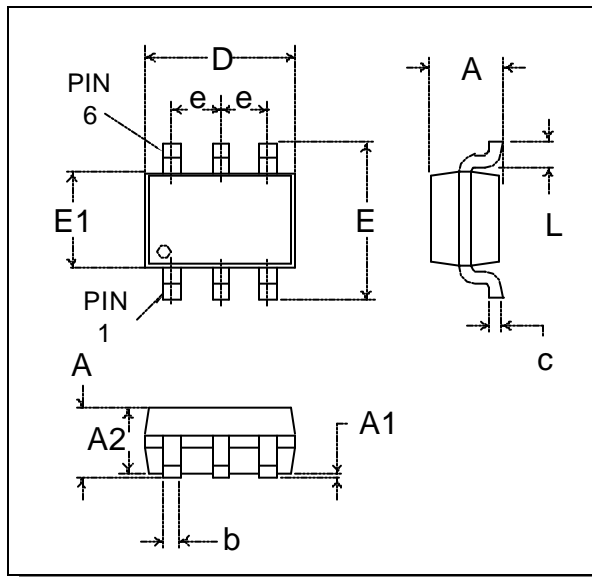
SC-70 (SOT-363) Plastic Package⁴

4. All dimensions are JEDEC MO-203-AB Issue A and are shown as in/mm.

Dim	Measurement (mm)		
	Min.	Nom.	Max.
A	-	-	1.10
A1	0	-	0.10
A2	0.70	0.90	1.00
b	0.15	-	0.30
c	0.08	-	0.25
D	-	2.00 basic	-
e	-	0.65 basic	-
E	-	2.10 basic	-
E1	-	1.25 basic	-
L	-	0.42 ref.	-

Ordering Information

Part Number	Package
SW-485	SC-70 (SOT-363) Plastic Package
SW-485TR-3000	Forward Tape and Reel, 3000 pcs
SW-485SMB	Sample Board

Specifications subject to change without notice.

■ North America: Tel. (800) 366-2266
 ■ Asia/Pacific: Tel.+81-44-844-8296, Fax +81-44-844-8298
 ■ Europe: Tel. +44 (1344) 869 595, Fax+44 (1344) 300 020

tyco / Electronics

MACOM

Typical Performance Curves

Insertion Loss vs. Frequency, Over Temperature, 39 pF

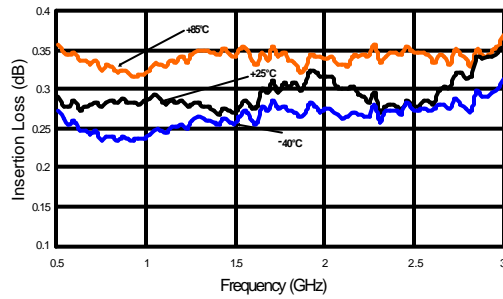

Insertion Loss vs. Frequency, Over Temperature, 1000 pF

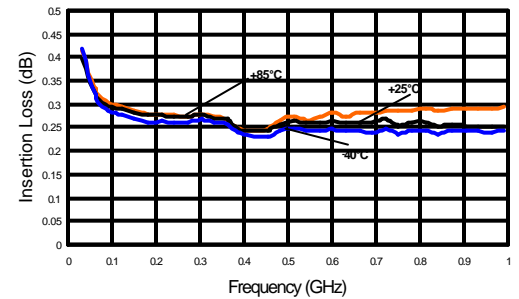

Isolation vs. Frequency, Over Temperature, 39 pF

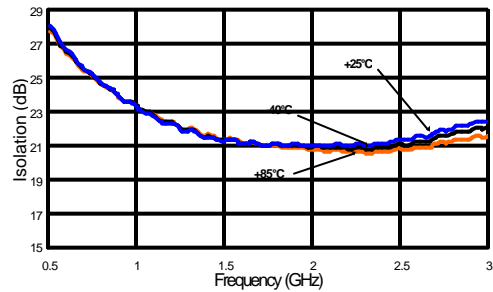

Isolation vs. Frequency, Over Temperature, 1000 pF

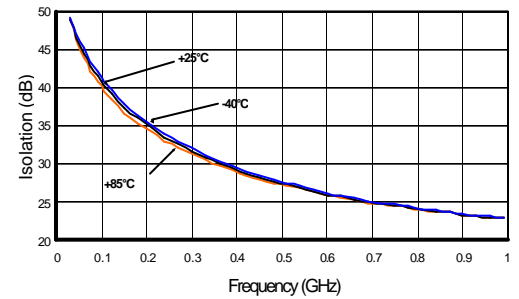

VSWR vs. Frequency, Over Temperature, 39 pF

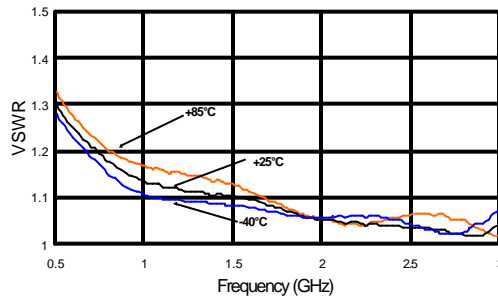

VSWR vs. Frequency, Over Temperature, 1000 pF

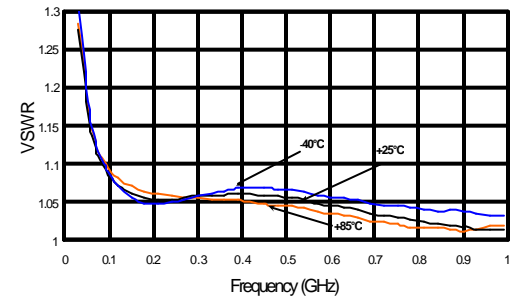

Specifications subject to change without notice.

- North America: Tel. (800) 366-2266
- Asia/Pacific: Tel.+81-44-844-8296, Fax +81-44-844-8298
- Europe: Tel. +44 (1344) 869 595, Fax+44 (1344) 300 020