



ACST6-7S

ASD™ AC Switch Family

OVER VOLTAGE PROTECTED AC POWER SWITCH

MAIN APPLICATIONS

- AC static switching in appliance & industrial control systems
- Induction motor drive actuator for:
 - Refrigerator / Freezer compressor
 - Dishwasher spray pump
 - Clothes drier tumble
- Actuator for the thermostat of a refrigerator or freezer

FEATURES

- $V_{DRM} / V_{RRM} = \pm 700V$
- Avalanche controlled device
- $I_{T(RMS)} = 1.5 A$ with no heat sink and $T_{amb} = 40^{\circ}C$
- $I_{T(RMS)} = 6A$ with $T_{CASE} = 105^{\circ}C$
- High noise immunity: static $dV/dt > 200 V/\mu s$
- Gate triggering current : $I_{GT} < 10 mA$
- Snubberless turn off commutation: $(di/dt)_c > 3.5A/ms$
- D²PAK, I²PAK, TO-220FPAB or TO-220 package

BENEFITS

- Enables equipment to meet IEC61000-4-5 standards
- High off-state reliability with planar technology
- Needs no external overvoltage protection
- Direct interface with the microcontroller
- Reduces the power component count

DESCRIPTION

The ACST6-7Sx belongs to the AC power switch family built around the ASD technology. This high performance device is adapted to home appliances or industrial systems and drives an induction motor up to 6A.

This ACST switch embeds a triac structure with a high voltage clamping device to absorb the inductive turn-off energy and withstand line transients such as those described in the IEC61000-4-5 standards.

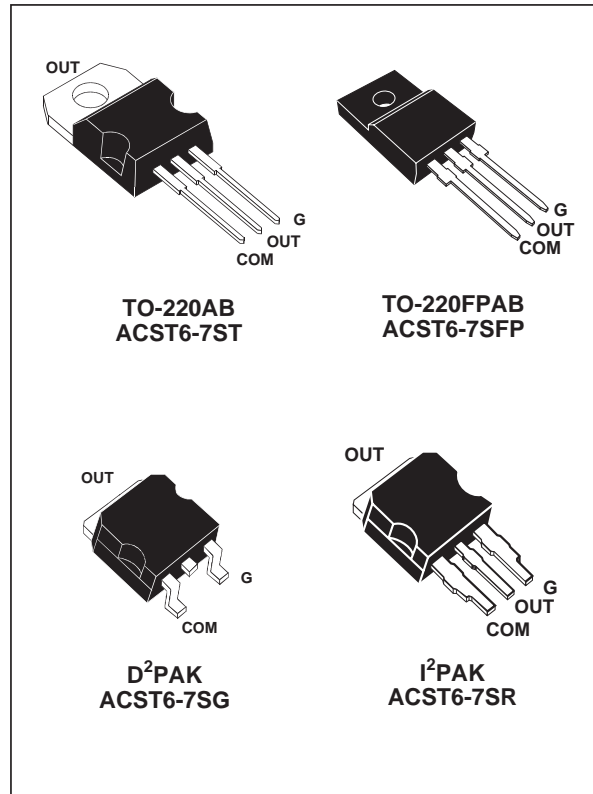

FUNCTIONAL DIAGRAM:

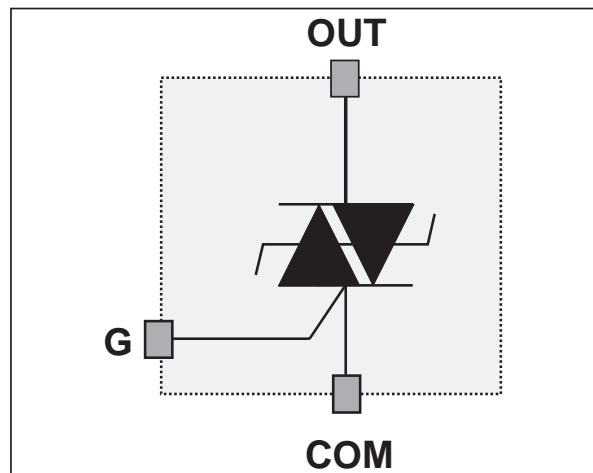

ACST6-7S

ABSOLUTE RATINGS (limiting values)

Symbol	Parameter		Value	Unit
V_{DRM} / V_{RRM}	Repetitive peak off-state voltage	$T_j = 125\text{ °C}$	700	V
$I_{T(RMS)}$	RMS on-state current full cycle sine wave 50 to 60 Hz, no heat sink	$T_{amb} = 40\text{ °C}$	1.5	A
	RMS on-state current full cycle sine wave 50 to 60 Hz, TO-220AB package	$T_{case} = 105\text{ °C}$	6	A
I_{TSM}	Non repetitive surge peak on-state current T_j initial = 25°C, full cycle sine wave	$t_p = 20\text{ms}$	45	A
		$t_p = 16.7\text{ms}$	50	A
I^2t	Thermal constraint for fuse selection	$t_p = 10\text{ms}$	11	A ² s
di/dt	Non repetitive on-state current critical rate of rise $I_G = 10\text{mA}$ ($t_R < 100\text{ns}$)	Rate period > 1mn	100	A/ μs
V_{PP}	Non repetitive line peak pulse voltage	note 1	2	kV
T_{stg}	Storage temperature range		- 40 to + 150	°C
T_j	Operating junction temperature range		- 30 to + 125	°C
TI	Maximum lead soldering temperature during 10s		260	°C

Note 1: according to test described by IEC61000-4-5 standard & Figure A.

GATE CHARACTERISTICS (maximum values)

Symbol	Parameter	Value	Unit
$P_{G(AV)}$	Average gate power dissipation	0.1	W
P_{GM}	Peak gate power dissipation ($t_p = 20\mu\text{s}$)	10	W
I_{GM}	Peak gate current ($t_p = 20\mu\text{s}$)	1	A

THERMAL RESISTANCE

Symbol	Parameter	Value	Unit
Rth (j-a)	Junction to ambient TO-220AB / TO-220FPAB	60	°C/W
Rth (j-a)	Junction to ambient I ² PAK	65	°C/W
Rth (j-a)	Junction to ambient D ² PAK soldered on 1cm ² copper pad	45	°C/W
Rth (j-c)	Junction to case for full cycle sine wave conduction (TO-220AB)	2.5	°C/W
Rth (j-c)	Junction to case for full cycle sine wave conduction (TO-220FPAB)	3.5	°C/W

PARAMETER DESCRIPTION

Parameter Symbol	Parameter description
I_{GT}	Gate triggering current
V_{GT}	Gate triggering voltage
V_{GD}	Non triggering voltage
I_H	Holding current
I_L	Latching current
V_{TM}	On state voltage
V_{TO}	On state characteristic threshold voltage
R_D	On state characteristic dynamic resistance
I_{DRM} / I_{RRM}	Forward or reverse leakage current
dV/dt	Static pin OUT voltage rise
$(dI/dt)_c$	Turn off current rate of decay
V_{CL}	Avalanche voltage at turn off

ELECTRICAL CHARACTERISTICS PER SWITCH

For either positive or negative polarity of pin OUT voltage in respect to pin COM voltage

Symbol	Test conditions		Values	Unit	
I_{GT}	$V_{out} = 12V$ (DC) $R_L = 33\Omega$	$T_j = 25^\circ C$	MAX.	10	mA
V_{GT}	$V_{out} = 12V$ (DC) $R_L = 33\Omega$	$T_j = 25^\circ C$	MAX.	1.5	V
V_{GD}	$V_{OUT} = V_{DRM}$ $R_L = 3.3k\Omega$	$T_j = 125^\circ C$	MIN.	0.2	V
I_H	$I_{OUT} = 100mA$ Gate open	$T_j = 25^\circ C$	MAX.	25	mA
I_L	$I_G = 20mA$	$T_j = 25^\circ C$	MAX.	50	mA
V_{TM}	$I_{OUT} = 2.1A$ $t_p = 380\mu s$	$T_j = 25^\circ C$	MAX.	1.4	V
V_{TM}	$I_{OUT} = 8.5A$ $t_p = 380\mu s$	$T_j = 25^\circ C$	MAX.	1.7	V
V_{to}		$T_j = 125^\circ C$	MAX.	0.9	V
R_D		$T_j = 125^\circ C$	MAX.	80	m Ω
I_{DRM} I_{RRM}	$V_{OUT} = V_{DRM}$ $V_{OUT} = V_{RRM}$	$T_j = 25^\circ C$	MAX.	20	μA
		$T_j = 125^\circ C$	MAX.	500	μA
dV/dt	$V_{OUT} = 600V$ gate open	$T_j = 125^\circ C$	MIN.	200	V/ μs
$(dI/dt)_c$	$(dV/dt)_c = 15V/\mu s$	$T_j = 125^\circ C$	MIN.	3	A/ms
$(dI/dt)_c$	$(dV/dt)_c = 15V/\mu s$ $I_{out} < 0$ $R_{gk} = 150\Omega$	$T_j = 125^\circ C$	MIN.	3.5	A/ms
V_{CL}	$I_{CL} = 1mA$ $t_p = 1ms$	$T_j = 25^\circ C$	TYP.	1100	V

ACST6-7S

AC LINE SWITCH BASIC APPLICATION

The ACST6-7S device is especially designed to drive medium power induction motors in refrigerators, dish washers, and tumble dryers.

- Pin COM : Common drive reference, to be connected to the power line neutral
- Pin G : Switch Gate input to be connected to the controller
- Pin OUT : Switch Output to be connected to the load

When driven from a low voltage controller, the ACST switch is triggered with a negative gate current flowing out of the gate pin G. It can be directly driven by the controller through a resistor as shown on the typical application diagram. In appliance systems, the ACST6-7S switch intends to drive medium power load in ON / OFF full cycle or phase angle control mode.

Thanks to its thermal and turn-off commutation characteristics, the ACST6-7S switch is able to drive an inductive load up to 6A without a turn-off aid snubber circuit.

TYPICAL APPLICATION DIAGRAM

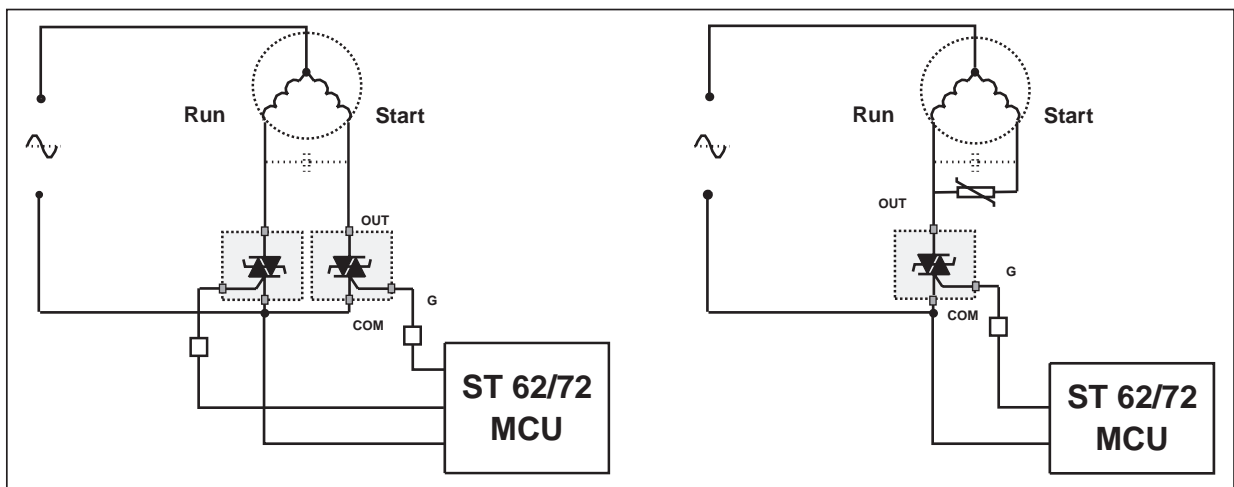

AC LINE TRANSIENT VOLTAGE RUGGEDNESS

The ACST6-7S switch is able to safely withstand the AC line transient voltages either by clamping the low energy spikes or by breaking over under high energy shocks.

The test circuit in Figure A is representative of the ACST application and is used to test the ACST switch according to the IEC61000-4-5 standard conditions. Thanks to the load impedance, the ACST switch withstands voltage spikes up to 2 kV above the peak line voltage by breaking over safely. Such non-repetitive testing can be done 10 times on each AC line voltage polarity.

Fig. A: Overvoltage ruggedness test circuit for resistive and inductive loads according to IEC61000-4-5 standard $R = 10\Omega$, $L = 5\mu\text{H}$ & $V_{PP} = 2\text{kV}$

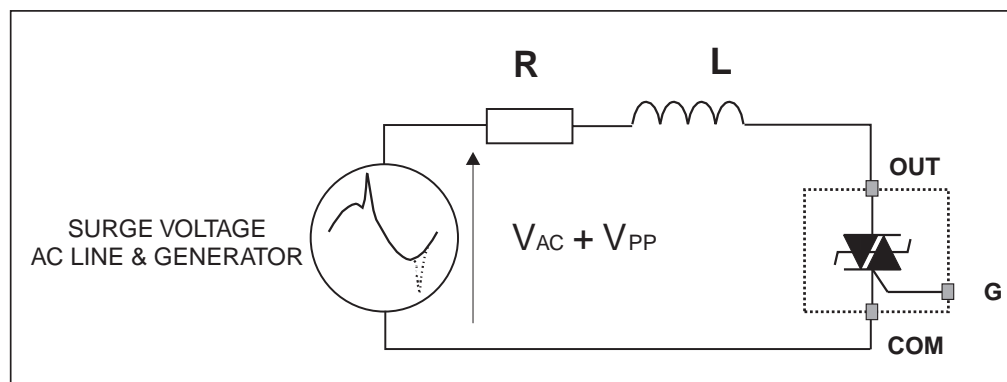

Fig. 1: Maximum power dissipation versus RMS on-state current (full cycle).

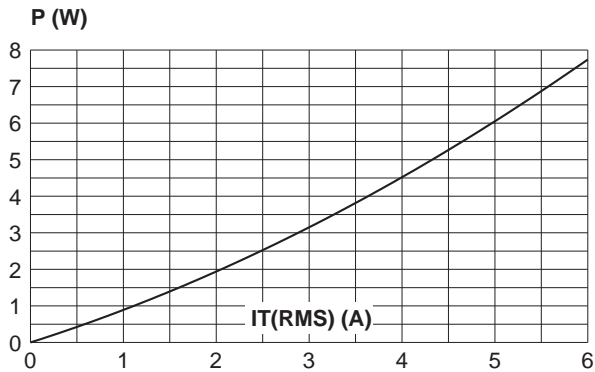

Fig. 2-1: RMS on-state current versus case temperature (full cycle).

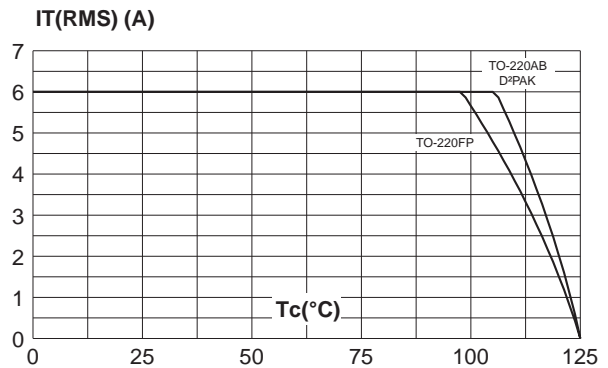

Fig. 2-2: RMS on-state current versus ambient temperature (printed circuit board FR4, copper thickness: 35µm), full cycle.

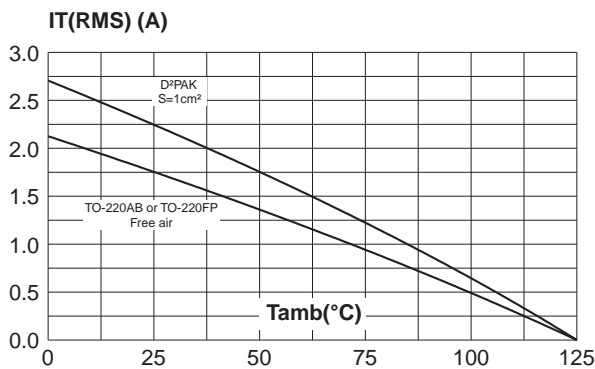

Fig. 3: Relative variation of thermal impedance versus pulse duration.

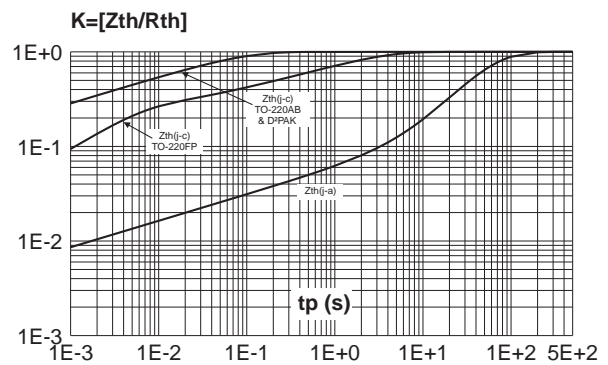

Fig. 4: On-state characteristics (maximum values).

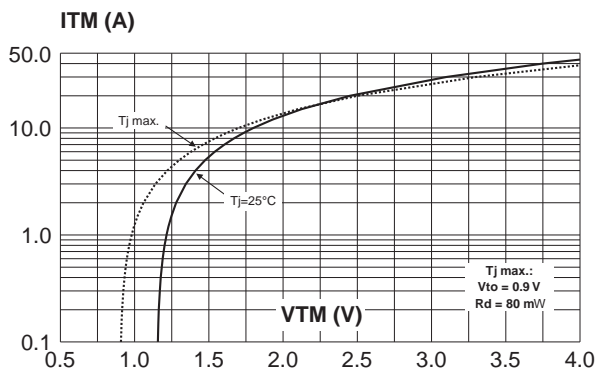

Fig. 5: Surge peak on-state current versus number of cycles.

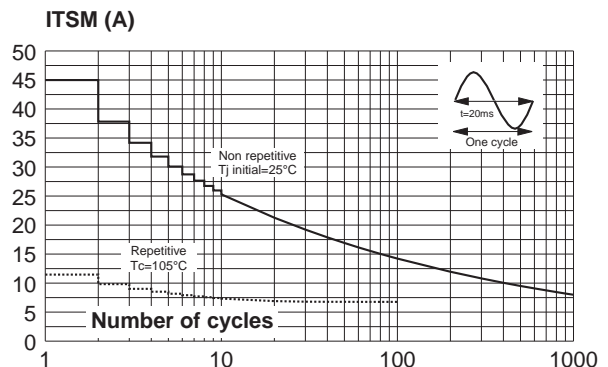

Fig. 6: Non repetitive surge peak on-state current for a sinusoidal pulse with width $t_p < 10\text{ms}$, and corresponding value of I^2t .

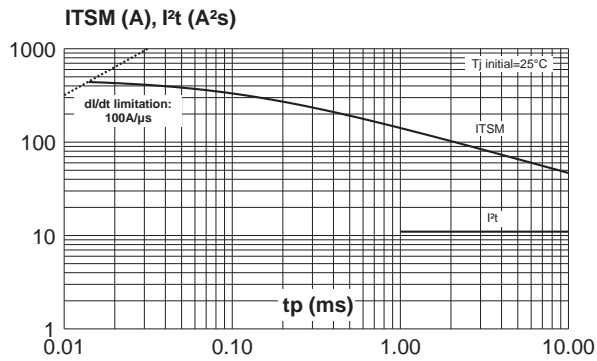

Fig. 8: Relative variation of critical rate of decrease of main current versus reapplied $(dV/dt)_c$ (typical values).

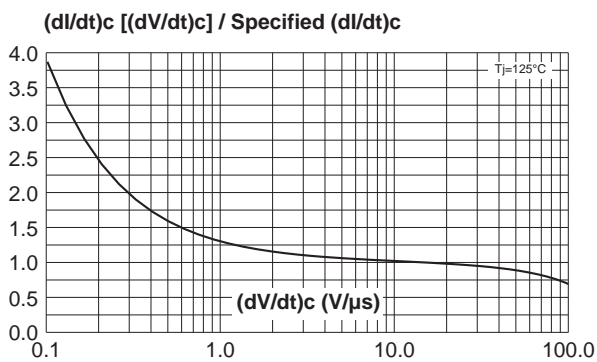

Fig. 10: Relative variation of dV/dt immunity versus junction temperature for different values of gate to com resistance (gate open is the reference value).

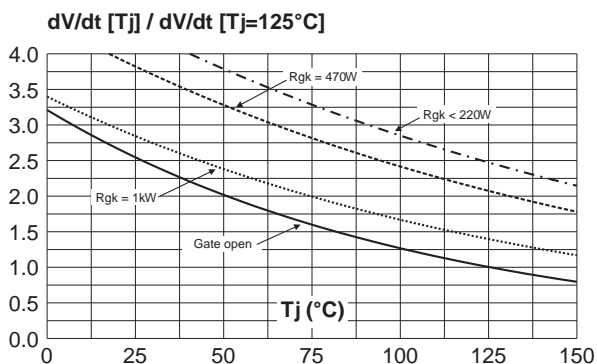

Fig. 7: Relative variation of gate trigger current, holding current and latching current versus junction temperature (typical values).

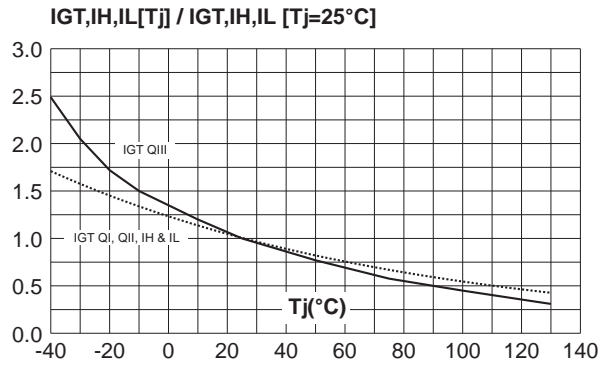

Fig. 9: Relative variation of critical rate of decrease of main current versus junction teperature.

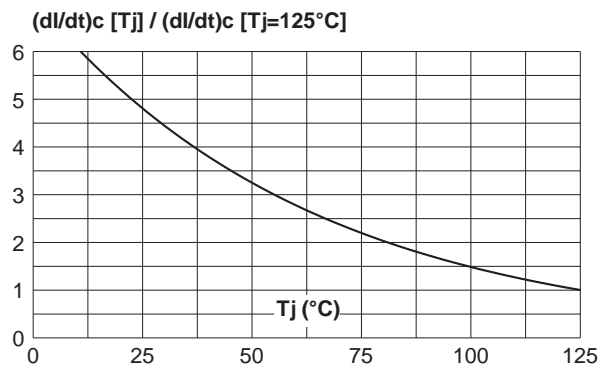
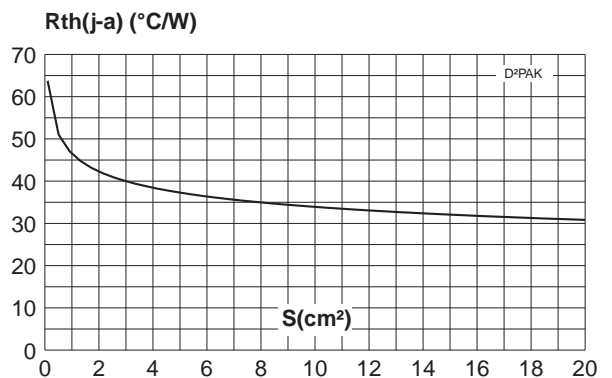
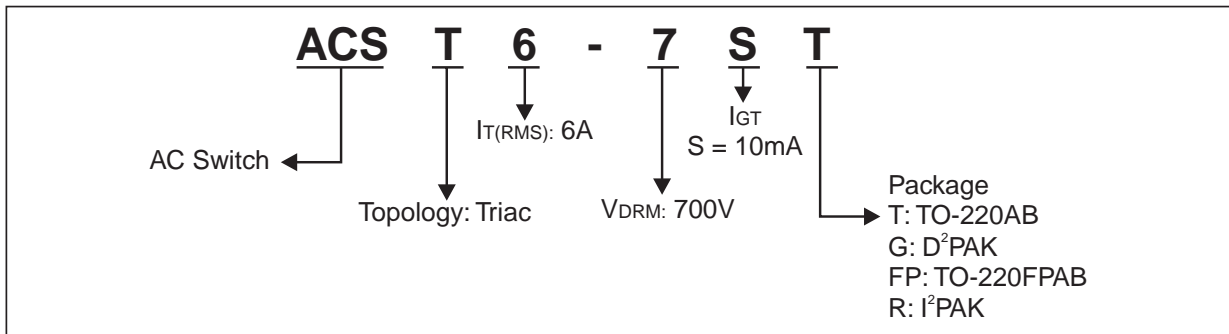

Fig. 11: Thermal resistance junction to ambient versus copper surface under tab (printed circuit board FR4, copper thickness: 35µm).



ORDERING INFORMATION



PACKAGE MECHANICAL DATA

D²PAK Plastic

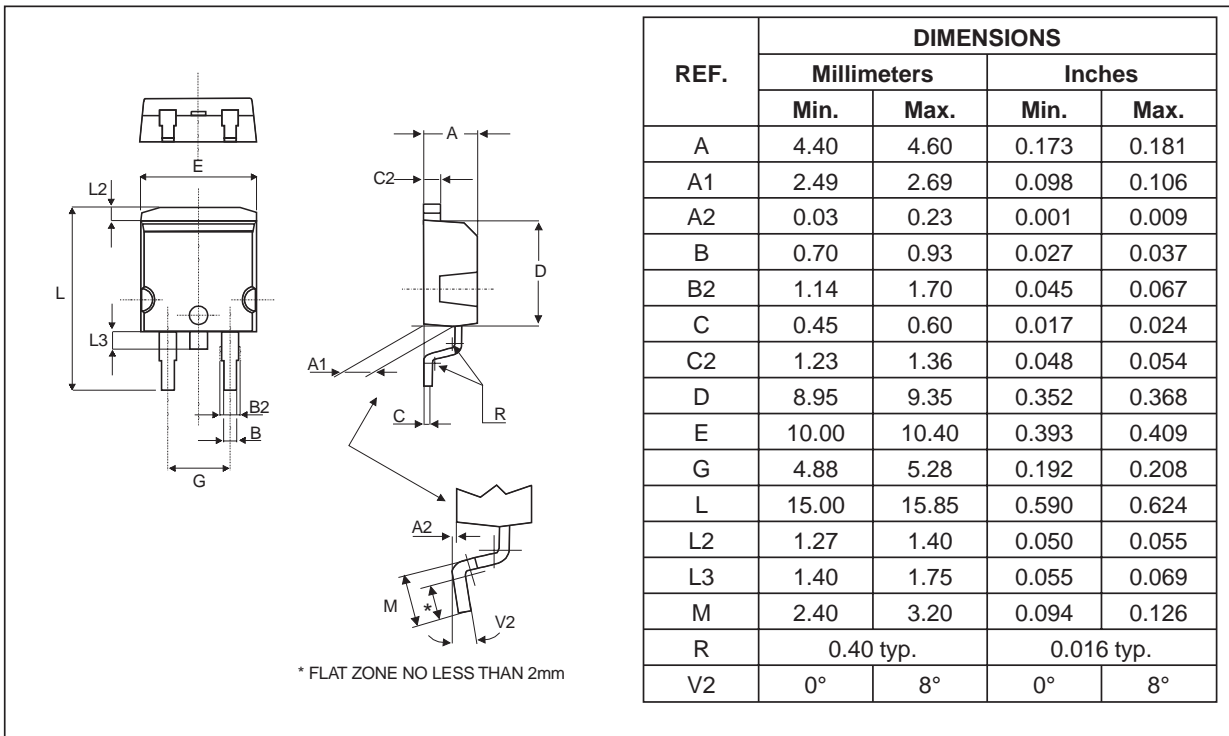

FOOTPRINT DIMENSIONS (in millimeters)

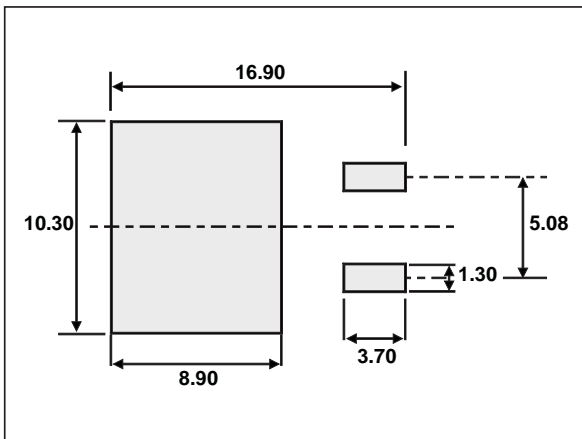

ACST6-7S

PACKAGE MECHANICAL DATA TO-220AB (Plastic)

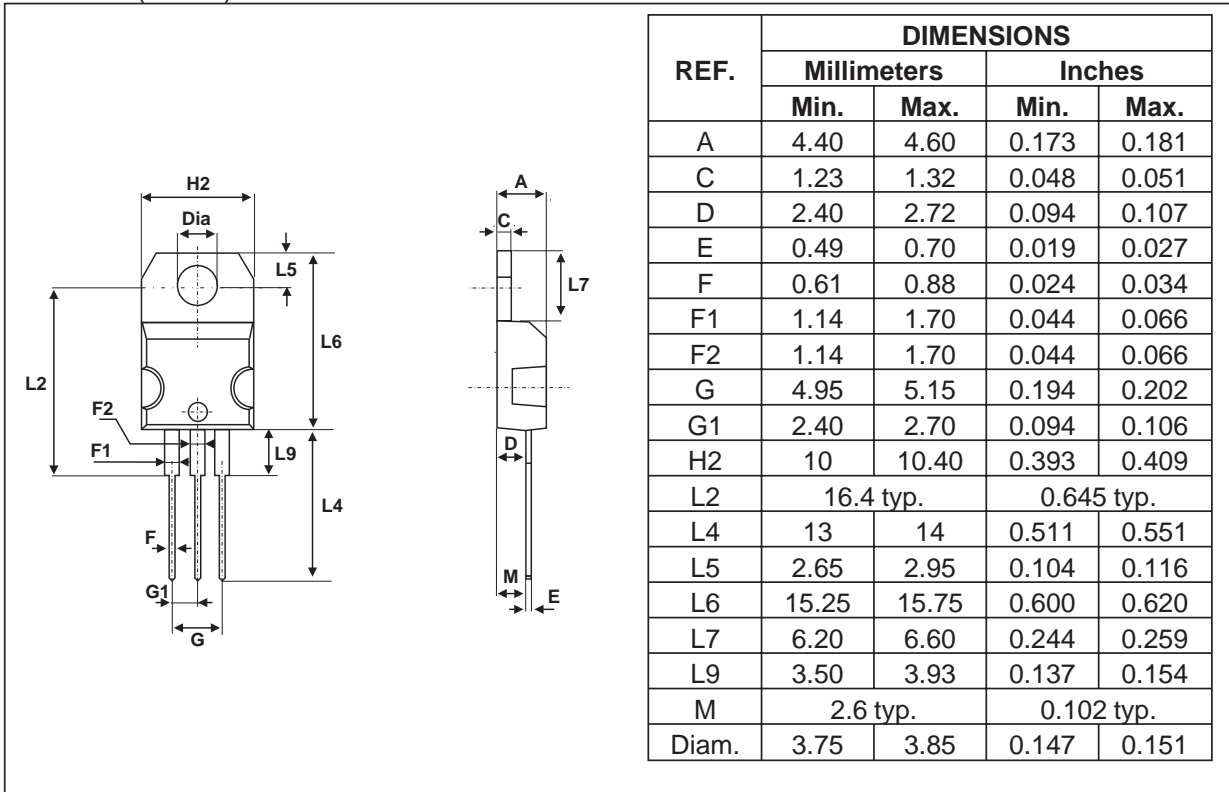

PACKAGE MECHANICAL DATA I²PAK

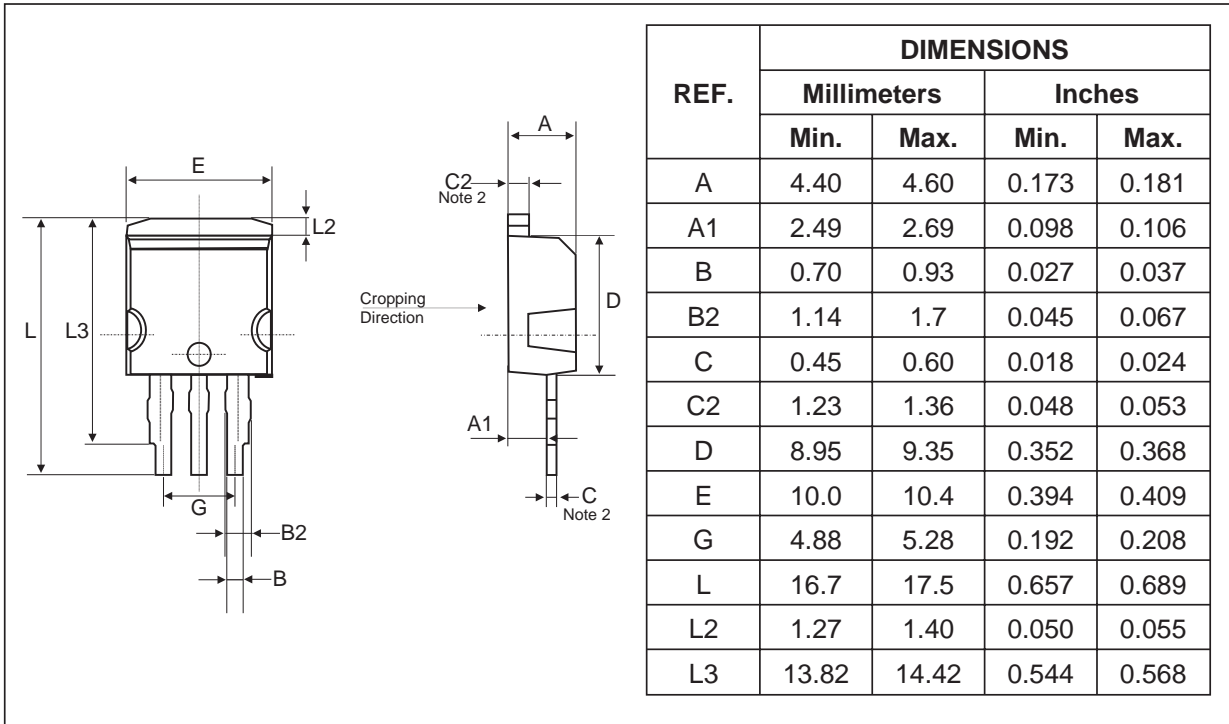

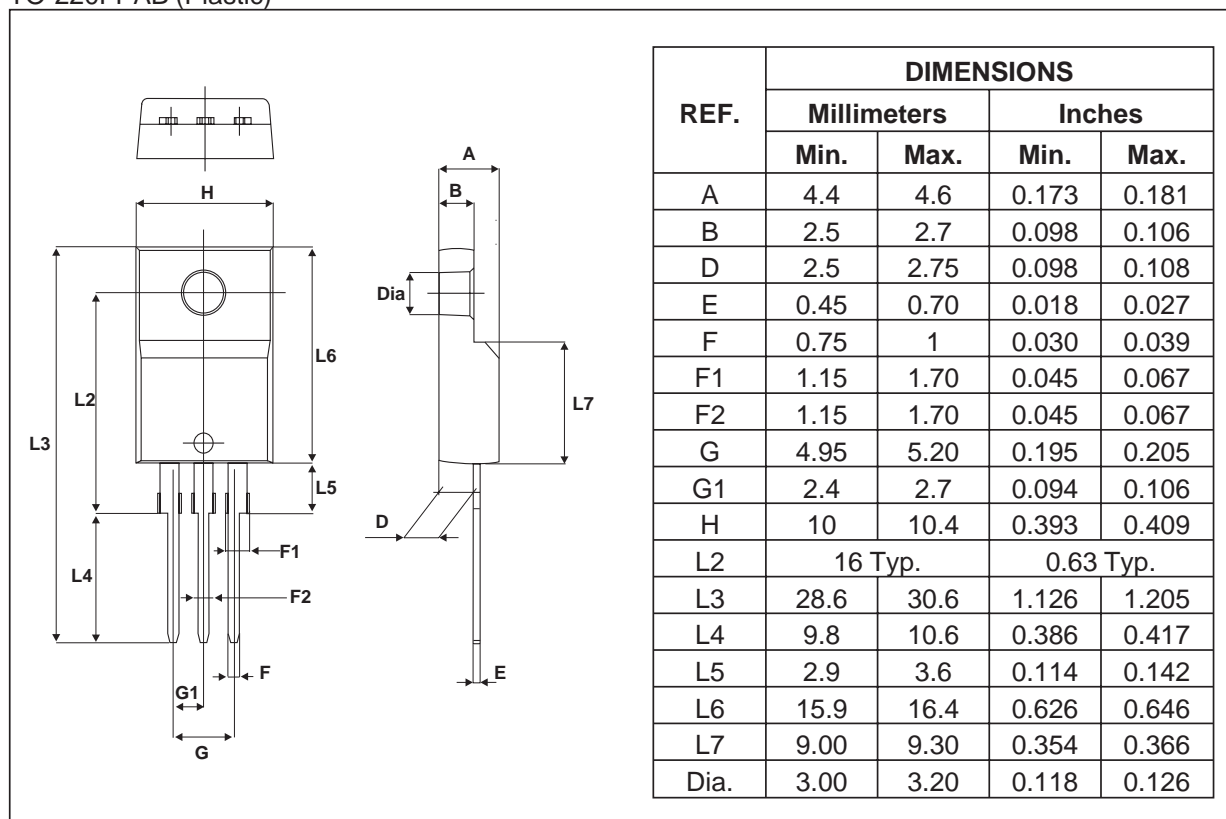
PACKAGE MECHANICAL DATA
 TO-220FPAB (Plastic)

OTHER INFORMATION

Ordering type	Marking	Package	Weight	Base qty	Delivery mode
ACST6-7ST	ACST67S	TO-220AB	2.3 g	50	Tube
ACST6-7SG	ACST67S	D ² PAK	1.5 g	50	Tube
ACST6-7SFP	ACST67S	TO-220FPAB	2.4 g	50	Tube
ACST6-7SR	ACST67S	I ² PAK	1.5 g	50	Tube

- Epoxy meets UL94,V0

Information furnished is believed to be accurate and reliable. However, STMicroelectronics assumes no responsibility for the consequences of use of such information nor for any infringement of patents or other rights of third parties which may result from its use. No license is granted by implication or otherwise under any patent or patent rights of STMicroelectronics. Specifications mentioned in this publication are subject to change without notice. This publication supersedes and replaces all information previously supplied. STMicroelectronics products are not authorized for use as critical components in life support devices or systems without express written approval of STMicroelectronics.

The ST logo is a registered trademark of STMicroelectronics

© 2002 STMicroelectronics - Printed in Italy - All rights reserved.

STMicroelectronics GROUP OF COMPANIES

Australia - Brazil - Canada - China - Finland - France - Germany
 Hong Kong - India - Israel - Italy - Japan - Malaysia - Malta - Morocco - Singapore
 Spain - Sweden - Switzerland - United Kingdom - United States.

<http://www.st.com>

Copyright © Each Manufacturing Company.

All Datasheets cannot be modified without permission.

This datasheet has been download from :

www.AllDataSheet.com

100% Free DataSheet Search Site.

Free Download.

No Register.

Fast Search System.

www.AllDataSheet.com