

# NCP5661

## Low Output Voltage, Ultra-Fast 1.0 A Low Dropout Linear Regulator with Enable

The NCP5661 is a high performance, low dropout linear regulator designed for high power applications that require up to 1.0 A current. It is offered in both fixed and adjustable output versions. With output voltages as low as 0.9 V and ultra-fast response times for load transients, the NCP5661 also provides additional features such as Enable and Error Flag (for the fixed output version), increasing the utility of this device. A thermally robust, 5 pin DPAK, combined with an architecture that offers low ground current (independent of load), provides for a superior high-current LDO solution.

### Features

- Ultra-Fast Transient Response (Settling Time: 1–3  $\mu$ s)
- Low Noise Without Bypass Capacitor ( $26 \mu$ V<sub>rms</sub>)
- Low Ground Current Independent of Load (3.0 mA Maximum)
- Fixed/Adjustable Output Voltage Versions
- Enable Function
- Error Flag (Fixed Output Version)
- Current Limit Protection
- Thermal Protection
- 0.9 V Reference Voltage for Ultra-Low Output Operation
- Power Supply Rejection Ratio > 65 dB
- These are Pb-Free Devices

### Applications

- Servers
- ASIC Power Supplies
- Post Regulation for Power Supplies
- Constant Current Source
- Networking Equipment
- Gaming and STB Modules



ON Semiconductor®

<http://onsemi.com>

### MARKING DIAGRAM

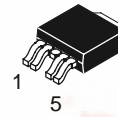

DPAK-5  
CENTER LEAD CROP  
CASE 175AA

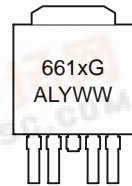

Tab = Ground  
Pin: 1. Enable  
2. V<sub>in</sub>  
3. Ground  
4. V<sub>out</sub>  
5. Adj (Adjustable Output)  
5. Error Flag (Fixed Output)

x = A for Adjustable Version  
B for Fixed 1.2 V  
C for Fixed 3.3 V

A = Assembly Location  
L = Wafer Lot  
Y = Year  
WW = Work Week  
G = Pb-Free

### ORDERING INFORMATION

See detailed ordering and shipping information in the package dimensions section on page 10 of this data sheet.

# NCP5661

## PIN FUNCTION DESCRIPTION

| Pin Adj/Fixed | Pin Name                      | Description   |
|---------------|-------------------------------|---|
| 1             | Enable                        | This pin allows for on/off control of the regulator. To disable the device, connect to Ground. If this function is not in use, connect to $V_{in}$ .                          |
| 2             | $V_{in}$                      | Positive Power Supply Input Voltage   |
| 3             | Ground                        | Power Supply Ground   |
| 4             | $V_{out}$                     | Regulated Output Voltage  |
| 5             | Adj<br>(Adjustable Version)   | This pin is connected to the resistor divider network and programs the output voltage.  |
| 5             | Error Flag<br>(Fixed Version) | An Error Flag is triggered when the output voltage is out of regulation excluding transient signals that may occur. Requires a pullup resistor $\approx 100\text{ k}\Omega$ . |

## MAXIMUM RATINGS

| Rating   | Symbol                             | Value                  | Unit                        |
|--|------------------------------------|------------------------|-----------------------------|
| Input Voltage  | $V_{in}$                           | 18                     | V                           |
| Output Pin Voltage   | $V_{out}$                          | -0.3 to $V_{in} + 0.3$ | V                           |
| Adjust Pin Voltage   | $V_{adj}$                          | -0.3 to $V_{in} + 0.3$ | V                           |
| Enable Pin Voltage   | $V_{en}$                           | -0.3 to $V_{in} + 0.3$ | V                           |
| Error Flag Voltage   | $V_{ef}$                           | -0.3 to $V_{in} + 0.3$ | V                           |
| Error Flag Current   | $I_{ef}$                           | 3.0                    | mA                          |
| Thermal Characteristics<br>Thermal Resistance, Junction-to-Air<br>Thermal Resistance, Junction-to-Case | $R_{\theta JA}$<br>$R_{\theta JC}$ | 100<br>8.0             | $^{\circ}\text{C}/\text{W}$ |
| Operating Junction Temperature Range   | $T_J$                              | -40 to +150            | $^{\circ}\text{C}$          |
| Storage Temperature Range  | $T_{stg}$                          | -55 to +150            | $^{\circ}\text{C}$          |

Maximum ratings are those values beyond which device damage can occur. Maximum ratings applied to the device are individual stress limit values (not normal operating conditions) and are not valid simultaneously. If these limits are exceeded, device functional operation is not implied, damage may occur and reliability may be affected.

NOTE: This device series contains ESD protection and exceeds the following tests:

Human Body Model (HBM) JESD 22-A114-B

Machine Model (MM) JESD 22-A115-A.

The maximum package power dissipation is:

$$P_D = \frac{T_{J(max)} - T_A}{R_{\theta JA}}$$

The bipolar process employed for this IC is fully characterized and rated for reliable 18 V  $V_{CCmax}$  operation. To avoid damaging the part or degrading its reliability, power dissipation transients should be limited to under 20 W for DPAK.

For open-circuit to short-circuit transient,

$$P_{Dtransient} = V_{CCmax} * I_{sc}$$

# NCP5661

## ELECTRICAL CHARACTERISTICS

( $V_{in} - V_{out} = 1.5$  V, for typical values  $T_J = 25^\circ\text{C}$ , for min/max values  $T_J = -40^\circ\text{C}$  to  $125^\circ\text{C}$ ,  $C_{in} = C_{out} = 150$   $\mu\text{F}$  unless otherwise noted.)

| Characteristic  | Symbol                     | Min                 | Typ           | Max                 | Unit                       |
|---|----------------------------|---------------------|---------------|---------------------|----------------------------|
| <b>ADJUSTABLE OUTPUT VERSION</b>  |                            |                     |               |                     |                            |
| Input Voltage   | $V_{in}$                   | 2.0                 | –             | 9.0                 | V                          |
| Output Noise Voltage  | $V_n$                      | –                   | 26            | –                   | $\mu\text{V}_{\text{rms}}$ |
| Output Voltage Accuracy<br>$T_J = 25^\circ\text{C}$ ( $I_{out} = 10$ mA to 1.0 A)<br>$T_J = -20$ to $+125^\circ\text{C}$ ( $I_{out} = 10$ mA to 1.0 A)<br>$T_J = -40$ to $+150^\circ\text{C}$ ( $I_{out} = 10$ mA to 1.0 A) | $V_{out}$                  | -1%<br>-1.5%<br>-2% | –<br>0.9<br>– | +1%<br>+1.5%<br>+2% | V                          |
| Adjustable Pin Input Current  | $I_{adj}$                  | –                   | 40            | –                   | nA                         |
| Line Regulation ( $I_{out} = 10$ mA, $V_{out} + 1.5$ V < $V_{in}$ < 7.0 V)  | $\text{REG}_{\text{line}}$ | –                   | 0.03          | –                   | %                          |
| Load Regulation (10 mA < $I_{out}$ < 1.0 A)   | $\text{REG}_{\text{load}}$ | –                   | 0.03          | –                   | %                          |
| Dropout Voltage ( $I_{out} = 1.0$ A)  | $V_{DO}$                   | –                   | 1.0           | 1.3                 | V                          |
| Peak Output Current Limit   | $I_{out}$                  | 1.0                 | –             | –                   | A                          |
| Internal Current Limitation   | $I_{lim}$                  | –                   | 1.5           | –                   | A                          |
| Ripple Rejection (120 Hz)   | RR                         | –                   | 70            | –                   | dB                         |
| Ripple Rejection (1.0 kHz)  |                            | –                   | 65            | –                   |                            |
| Thermal Shutdown (Guaranteed by Design)   | $T_{\text{SHD}}$           | –                   | 160           | –                   | $^\circ\text{C}$           |
| Ground Current<br><br>$I_{out} = 1.0$ A<br>Disabled State   | $I_q$<br>$I_{qds}$         | –<br>–              | 1.3<br>10     | 3.0<br>300          | mA<br>$\mu\text{A}$        |
| Enable Input Threshold Voltage<br><br>Voltage Increasing, On State, Logic High<br>Voltage Decreasing, Off State, Logic Low  | $V_{en}$                   | 1.3<br>–            | –<br>–        | –<br>0.3            | V                          |
| Enable Input Current<br><br>Enable Pin Voltage = $0.3 V_{\text{max}}$<br>Enable Pin Voltage = $1.3 V_{\text{min}}$  | $I_{en}$                   | –<br>–              | 0.5<br>0.5    | –<br>–              | $\mu\text{A}$              |

# NCP5661

## ELECTRICAL CHARACTERISTICS

( $V_{in} - V_{out} = 1.5$  V, for typical values  $T_J = 25^\circ\text{C}$ , for min/max values  $T_J = -40^\circ\text{C}$  to  $125^\circ\text{C}$ ,  $C_{in} = C_{out} = 150$   $\mu\text{F}$  unless otherwise noted.)

| Characteristic   | Symbol                     | Min                 | Typ                 | Max                 | Unit                       |
|--|----------------------------|---------------------|---------------------|---------------------|----------------------------|
| <b>FIXED OUTPUT VOLTAGE</b>  |                            |                     |                     |                     |                            |
| Input Voltage  | $V_{in}$                   | 2.0                 | –                   | 9.0                 | V                          |
| Output Noise Voltage ( $V_{out} = 0.9$ V)  | $V_n$                      | –                   | 26                  | –                   | $\mu\text{V}_{\text{rms}}$ |
| Output Voltage Accuracy (Note 1)<br>$T_J = 25^\circ\text{C}$ ( $I_{out} = 10$ mA to 1.0 A)<br>$T_J = -20$ to $+125^\circ\text{C}$ ( $I_{out} = 10$ mA to 1.0 A)<br>$T_J = -40$ to $+150^\circ\text{C}$ ( $I_{out} = 10$ mA to 1.0 A) | $V_{out}$                  | –1%<br>–1.5%<br>–2% | –<br>$V_{out}$<br>– | +1%<br>+1.5%<br>+2% | V                          |
| Line Regulation ( $I_{out} = 10$ mA, $V_{out} + 1.5$ V < $V_{in}$ < 7.0 V)   | $\text{REG}_{\text{line}}$ | –                   | 0.03                | –                   | %                          |
| Load Regulation (10 mA < $I_{out}$ < 1.0 A)  | $\text{REG}_{\text{load}}$ | –                   | 0.2                 | –                   | %                          |
| Dropout Voltage ( $I_{out} = 1.0$ A)   | $V_{DO}$                   | –                   | 1.0                 | 1.3                 | V                          |
| Peak Output Current Limit  | $I_{out}$                  | 1.0                 | –                   | –                   | A                          |
| Internal Current Limitation  | $I_{lim}$                  | –                   | 1.5                 | –                   | A                          |
| Ripple Rejection (120 Hz)  | RR                         | –                   | 70                  | –                   | dB                         |
| Ripple Rejection (1.0 kHz)   |                            | –                   | 65                  | –                   |                            |
| Thermal Shutdown (Guaranteed by Design)  | $T_{SHD}$                  | –                   | 160                 | –                   | $^\circ\text{C}$           |
| Ground Current<br><br>$I_{out} = 1.0$ A<br>Disabled State  | $I_q$<br>$I_{qds}$         | –<br>–              | 1.3<br>30           | 3.0<br>300          | mA<br>$\mu\text{A}$        |
| Enable Input Threshold Voltage<br>Voltage Increasing, On State, Logic High<br>Voltage Decreasing, Off State, Logic Low   | $V_{en}$                   | 1.3<br>–            | –<br>–              | –<br>0.3            | V                          |
| Enable Input Current<br>Enable Pin Voltage = $0.3 V_{max}$<br>Enable Pin Voltage = $1.3 V_{min}$   | $I_{en}$                   | –<br>–              | 0.5<br>0.5          | –<br>–              | $\mu\text{A}$              |
| Error Flag (Fixed Output)<br>1.2 V Output<br>3.3 V Output  | $V_{eflt}$                 | 88<br>90            | 92<br>94            | 97<br>97            | % of $V_{out}$             |
| Error Flag Output Low Voltage Saturation ( $I_{ef} = 1.0$ mA)  | $V_{efdo}$                 | –                   | 200                 | –                   | mV                         |
| Error Flag Leakage   | $I_{efleak}$               | –                   | 1.0                 | –                   | $\mu\text{A}$              |
| Error Flag Blanking Time (Note 2)  | $T_{ef}$                   | –                   | 50                  | –                   | $\mu\text{s}$              |

- Fixed output voltages available at 0.9 V, 1.2 V, 1.5 V, 1.8 V, 2.5 V, 3.0 V, 3.3 V per request.
- Can be disabled per customer request.

# NCP5661

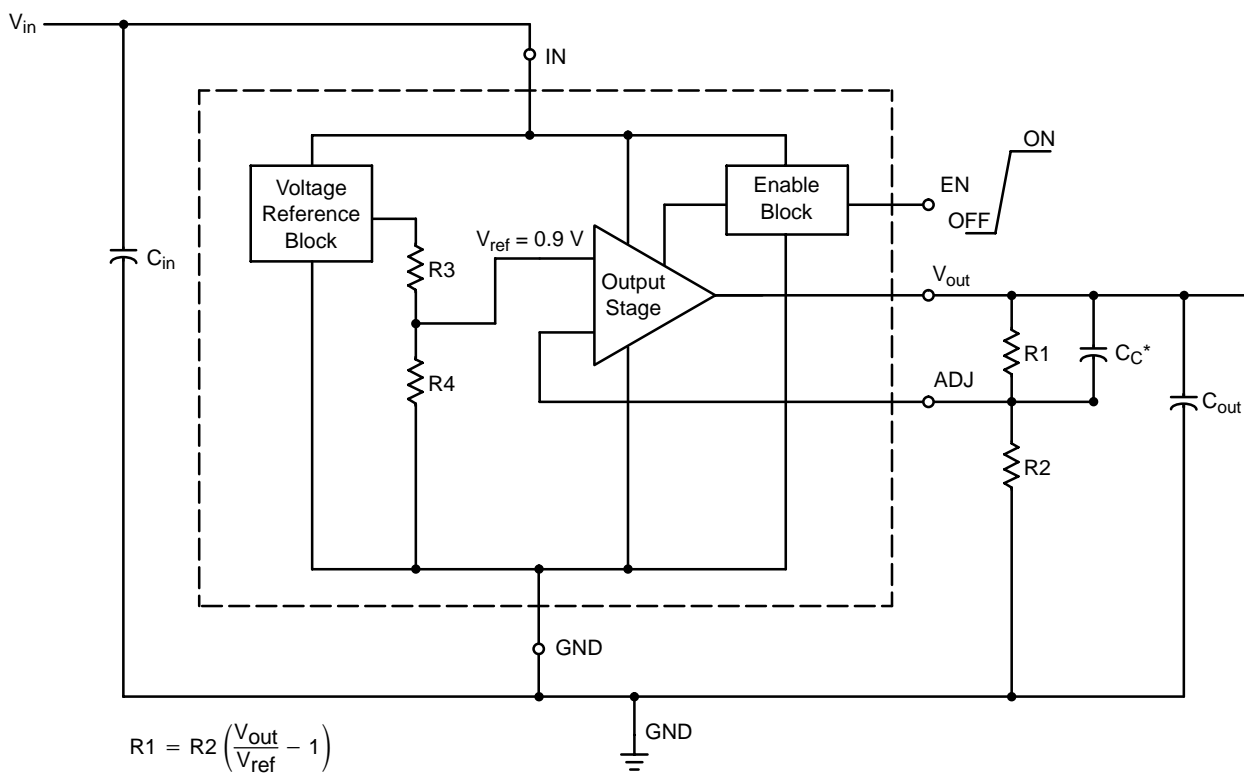

Figure 1. Typical Schematic, Adjustable Output Version

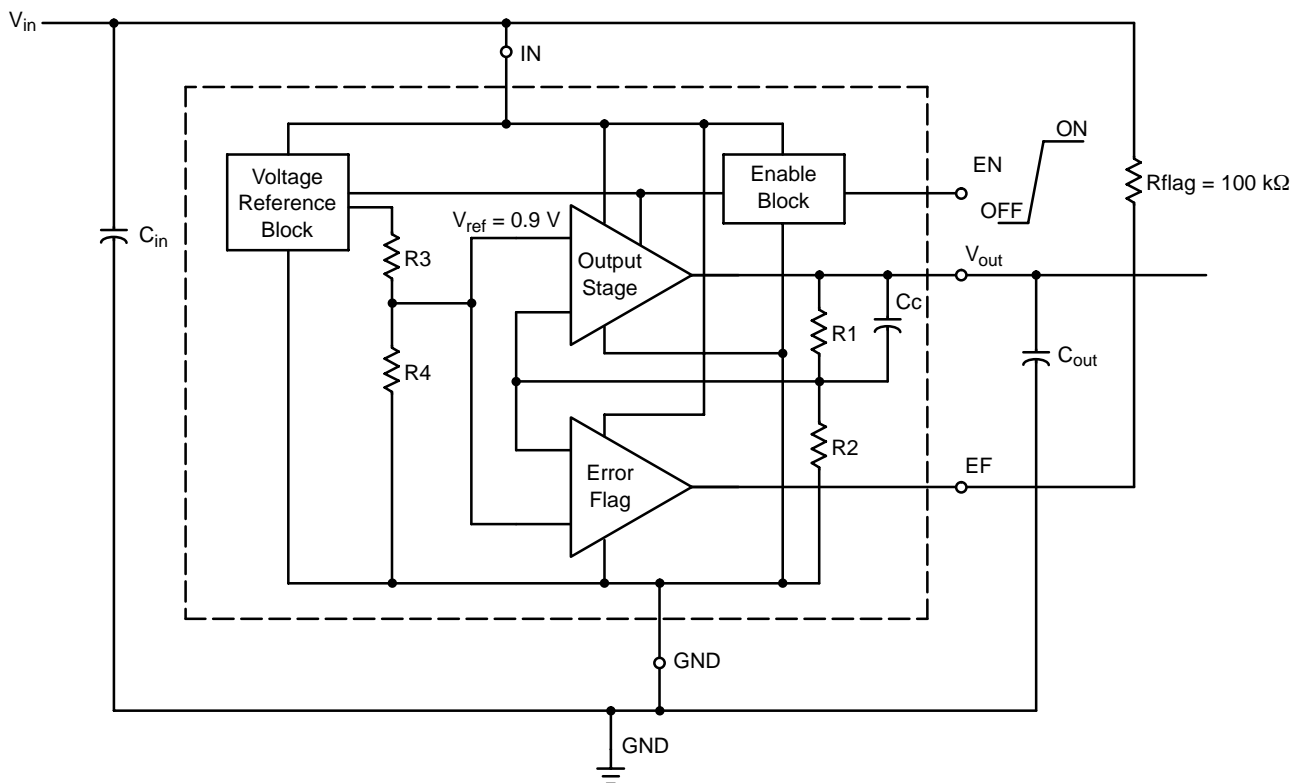

Figure 2. Typical Schematic, Fixed Output Version

# NCP5661

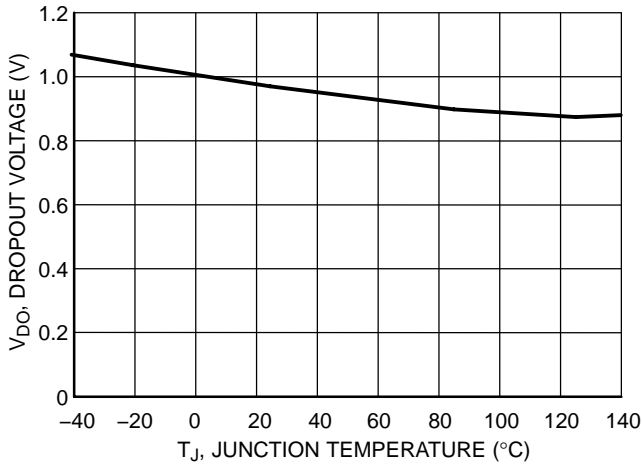

Figure 3. Dropout Voltage vs. Temperature

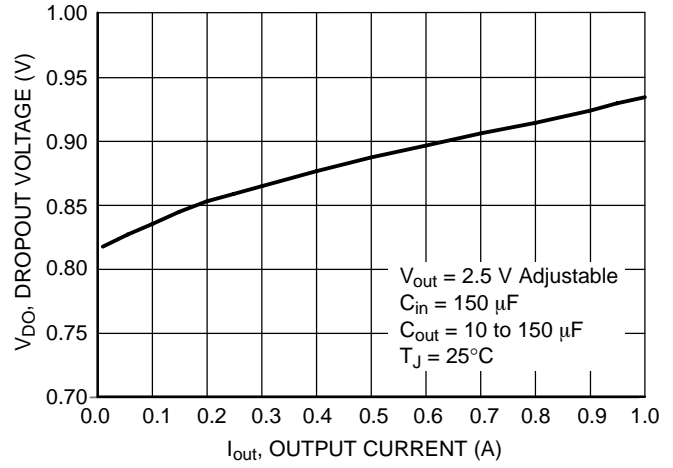

Figure 4. Dropout Voltage vs. Output Current

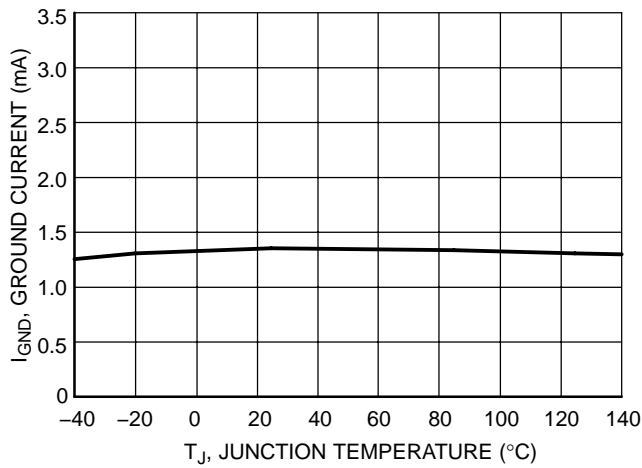

Figure 5. Ground Current vs. Temperature

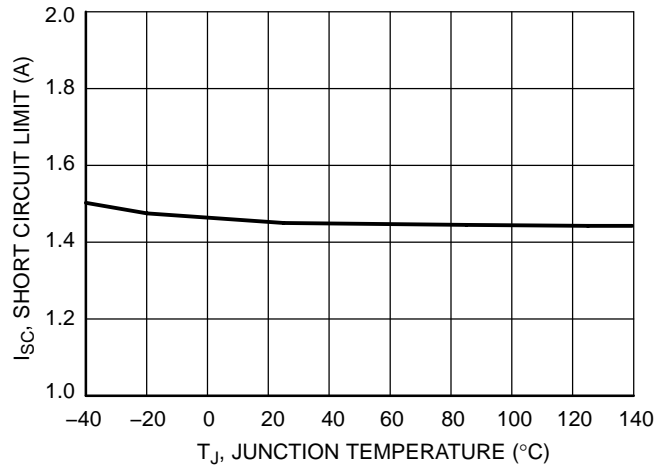

Figure 6. Short Circuit Current Limit vs. Temperature

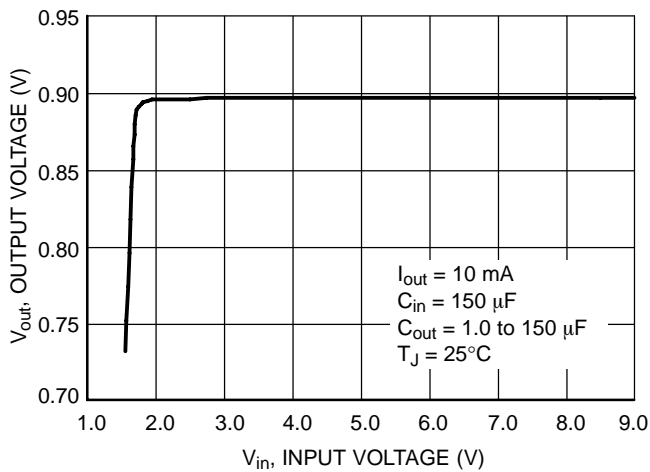

Figure 7. Output Voltage vs. Input Voltage

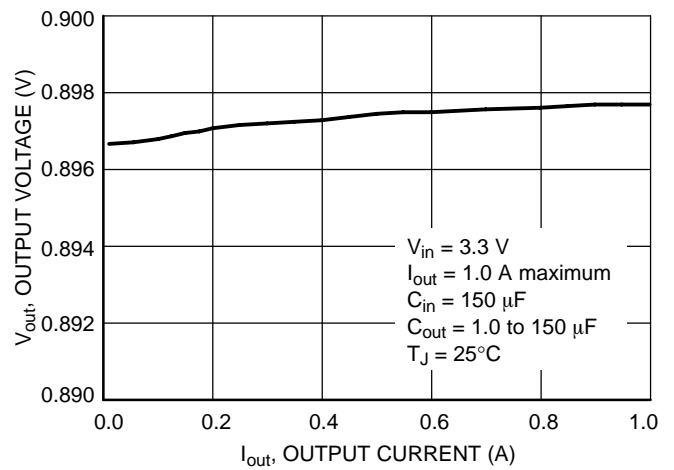
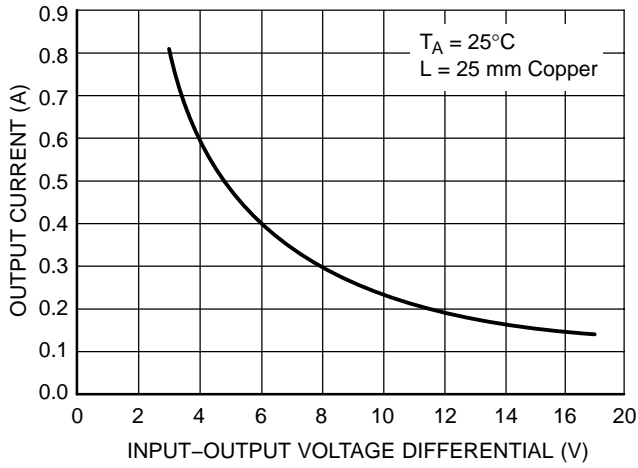
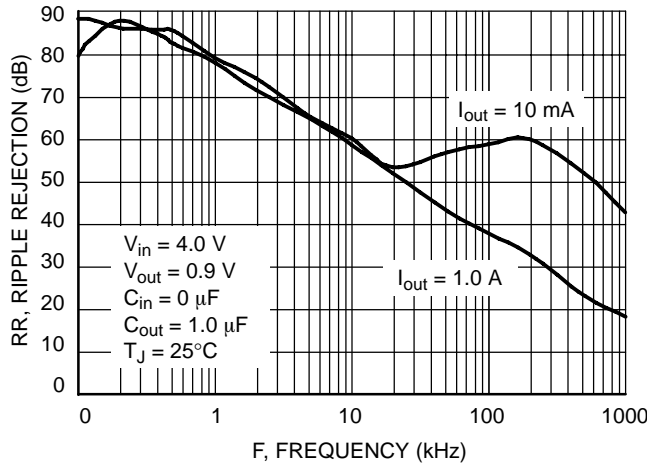

Figure 8. Output Voltage vs. Output Load Current

# NCP5661



**Figure 9. Output Current vs. Input-Output Voltage Differential**



**Figure 10. Ripple Rejection vs. Frequency**

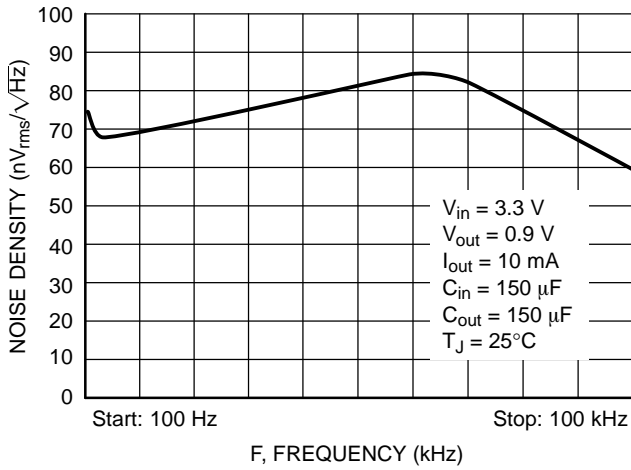

**Figure 11. Noise Density vs. Frequency**

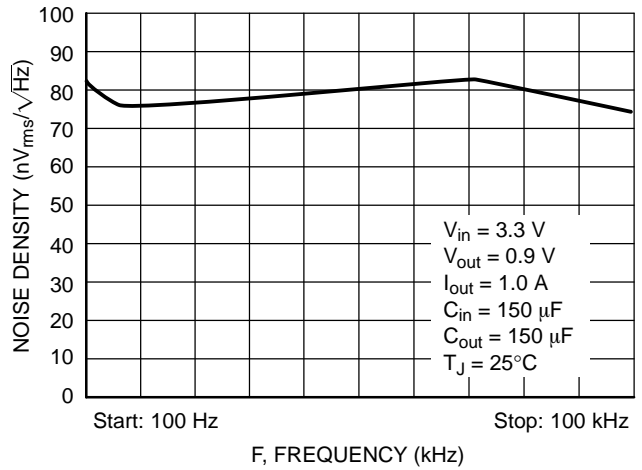

**Figure 12. Noise Density vs. Frequency**

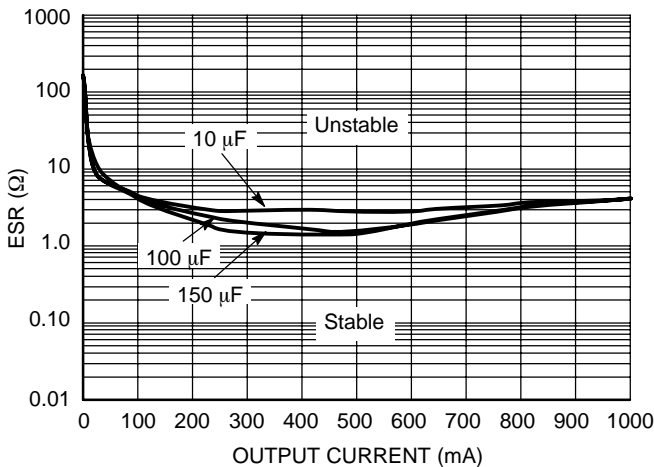

**Figure 13. 1.2 Volt Output Stability with Output Capacitor ESR**

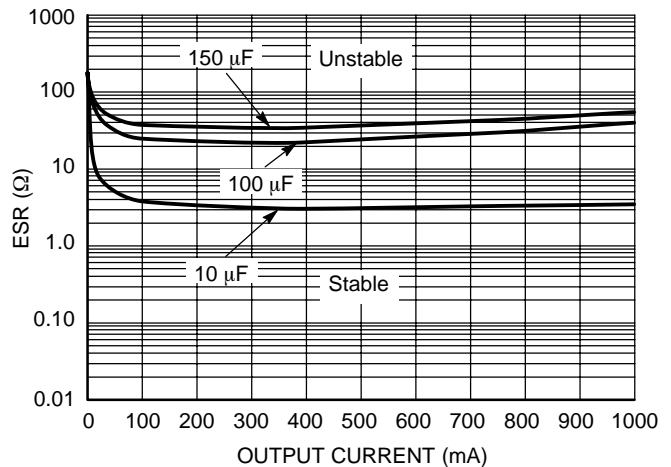

**Figure 14. 3.3 Volt Output Stability with Output Capacitor ESR**

## NCP5661

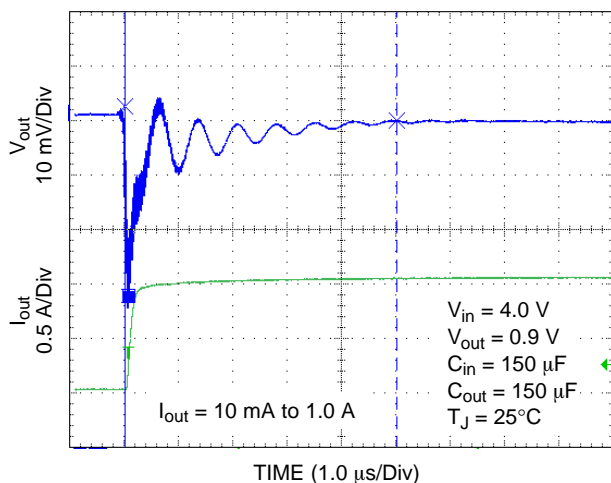

Figure 15. Load Transient Response

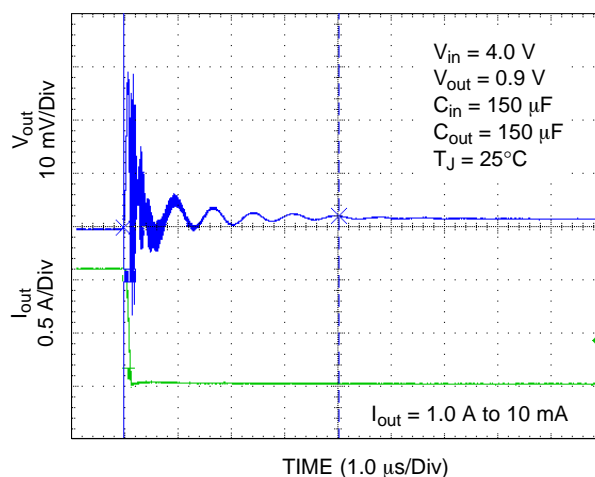

Figure 16. Load Transient Response

### APPLICATION INFORMATION

The NCP5661 is a high performance low dropout 1.0 A linear regulator suitable for high power applications, featuring an ultra-fast response time and low noise without a bypass capacitor. It is offered in both fixed and adjustable output versions with voltages as low as 0.9 V. Additional features, such as Enable and Error Flag (fixed output version) increase the utility of the NCP5661. It is thermally robust and includes the safety features necessary during a fault condition, which provide for an attractive high current LDO solution for server, ASIC power supplies, networking equipment applications, and many others.

#### Input Capacitor

The recommended input capacitor value is a 150  $\mu\text{F}$  OSCON with an Equivalent Series Resistance (ESR) of 50 m $\Omega$ . It is especially required if the power source is located more than a few inches from the NCP5661. This capacitor will reduce device sensitivity and enhance the output transient response time. The PCB layout is very important and in order to obtain the optimal solution, the  $V_{in}$  and GND traces should be sufficiently wide to minimize noise and unstable operation.

#### Output Capacitor

Proper output capacitor selection is required to maintain stability. The NCP5661 is guaranteed to be stable at an output capacitance of,  $C_{out} > 10 \mu\text{F}$  with an ESR  $< 300 \text{ m}\Omega$  over the output current range of 10 mA to 1.0 A. For PCB layout considerations, place the recommended ceramic capacitor close to the output pin and keep the leads short. This should help ensure ultra-fast transient response times.

#### Adjustable Output Operation

The application circuit for the adjustable output version is shown in Figure 1. The reference voltage is 0.9 V and the adjustable pin current is typically 40 nA. A resistor divider network, R1 and R2, is calculated using the following formula:

$$R1 = R2 \left( \frac{V_{out}}{V_{ref}} - 1 \right)$$

#### Current Limit Operation

As the peak output current increases beyond its limitation, the device is internally clamped to 1.5 A, thus causing the output voltage to decrease and go out of regulation. This allows the device never to exceed the maximum power dissipation.

#### Error Flag Operation

The Error Flag pin on the NCP5661 will produce a logic Low when it drops below the nominal output voltage. Refer to the electrical characteristics for the threshold values at which point the Error Flag goes Low. When the NCP5661 is above the nominal output voltage, the Error Flag will remain at logic High.

The external pullup resistor needs to be connected between  $V_{in}$  (Pin 1) and the Error Flag pin (Pin 5). A resistor of approximately 100 k $\Omega$  is recommended to minimize the current consumption. No pullup resistor is required if the Error Flag output is not being used.



# NCP5661

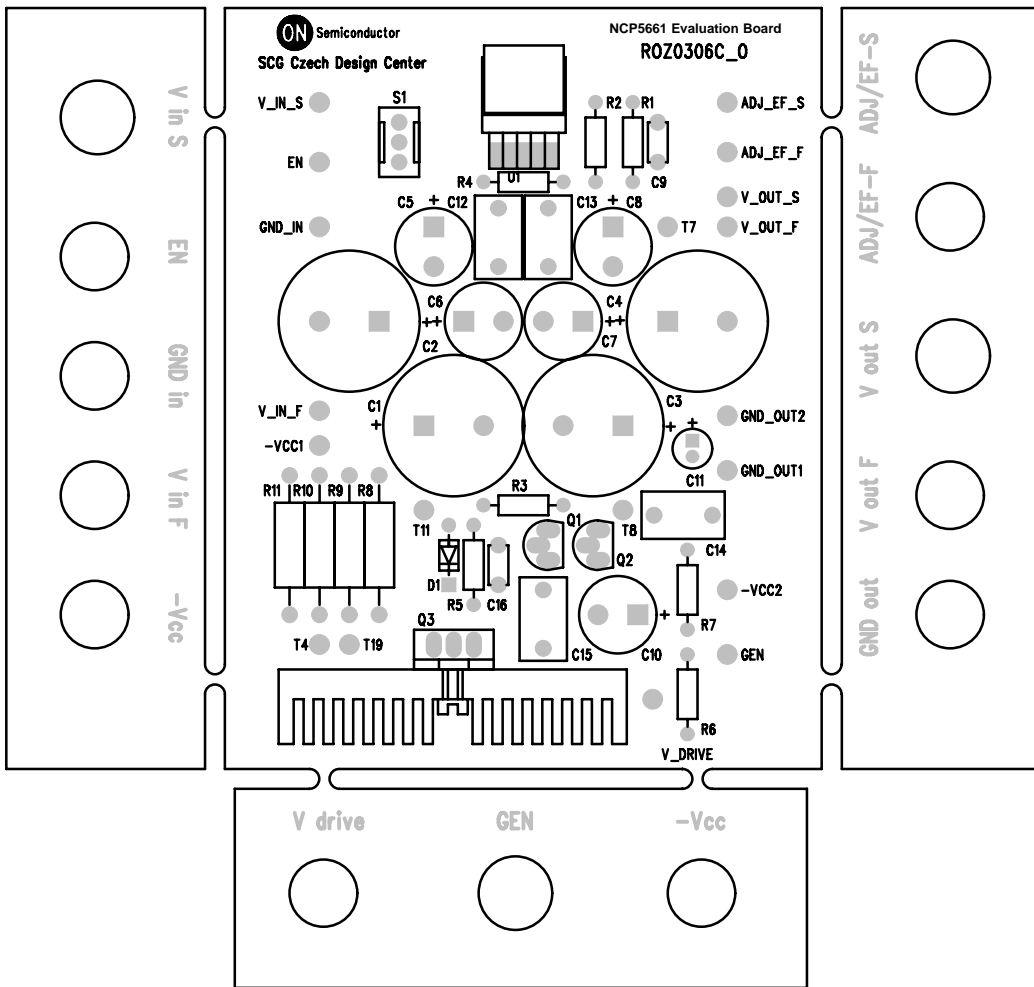

Figure 17. Test Board used for Evaluation

## NCP5661

### ORDERING INFORMATION

| Device                  | Nominal Output Voltage    | Package | Shipping†        |
|-------------------------|---------------------------|---------|------------------|
| NCP5661DTADJRKG         | Adj<br>(Pb-Free)          | DPAK    | 2500 Tape & Reel |
| NCP5661DT12RKG (Note 3) | Fixed, 1.2 V<br>(Pb-Free) |         | 2500 Tape & Reel |
| NCP5661DT33RKG (Note 3) | Fixed, 3.3 V<br>(Pb-Free) |         | 2500 Tape & Reel |

3. Fixed output voltages available at 0.9 V, 1.5 V, 1.8 V, 2.5 V, 3.0 V per request.

†For information on tape and reel specifications, including part orientation and tape sizes, please refer to our Tape and Reel Packaging Specifications Brochure, BRD8011/D.

# NCP5661

## PACKAGE DIMENSIONS

### DPAK-5 CENTER LEAD CROP CASE 175AA-01 ISSUE A

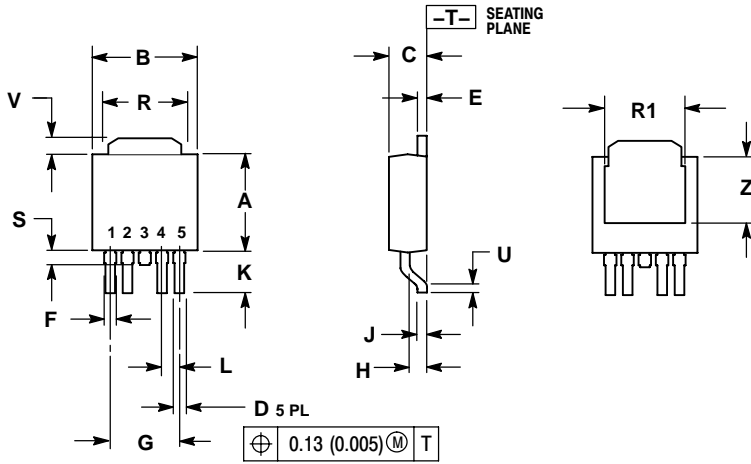

- NOTES:  
 1. DIMENSIONING AND TOLERANCING PER ANSI Y14.5M, 1982.  
 2. CONTROLLING DIMENSION: INCH.

| DIM | INCHES    |       | MILLIMETERS |      |
|-----|-----------|-------|-------------|------|
|     | MIN       | MAX   | MIN         | MAX  |
| A   | 0.235     | 0.245 | 5.97        | 6.22 |
| B   | 0.250     | 0.265 | 6.35        | 6.73 |
| C   | 0.086     | 0.094 | 2.19        | 2.38 |
| D   | 0.020     | 0.028 | 0.51        | 0.71 |
| E   | 0.018     | 0.023 | 0.46        | 0.58 |
| F   | 0.024     | 0.032 | 0.61        | 0.81 |
| G   | 0.180 BSC |       | 4.56 BSC    |      |
| H   | 0.034     | 0.040 | 0.87        | 1.01 |
| J   | 0.018     | 0.023 | 0.46        | 0.58 |
| K   | 0.102     | 0.114 | 2.60        | 2.89 |
| L   | 0.045 BSC |       | 1.14 BSC    |      |
| R   | 0.170     | 0.190 | 4.32        | 4.83 |
| R1  | 0.185     | 0.210 | 4.70        | 5.33 |
| S   | 0.025     | 0.040 | 0.63        | 1.01 |
| U   | 0.020     | ---   | 0.51        | ---  |
| V   | 0.035     | 0.050 | 0.89        | 1.27 |
| Z   | 0.155     | 0.170 | 3.93        | 4.32 |

### SOLDERING FOOTPRINT\*

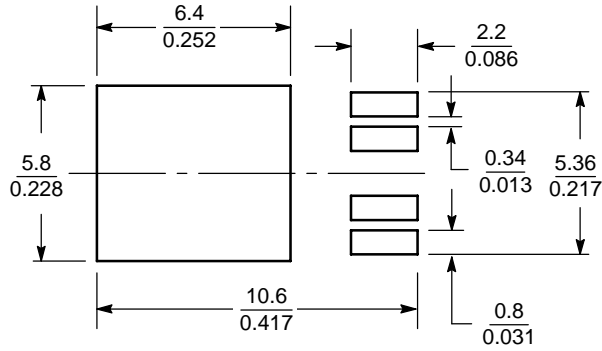

SCALE 4:1  $\left(\frac{\text{mm}}{\text{inches}}\right)$

\*For additional information on our Pb-Free strategy and soldering details, please download the ON Semiconductor Soldering and Mounting Techniques Reference Manual, SOLDERRM/D.

# NCP5661

The product described herein (NCP5661), may be covered by one or more of the following U.S. patents: 5,920,184; 5,834,926. There may be other patents pending.

**ON Semiconductor** and  are registered trademarks of Semiconductor Components Industries, LLC (SCILLC). SCILLC reserves the right to make changes without further notice to any products herein. SCILLC makes no warranty, representation or guarantee regarding the suitability of its products for any particular purpose, nor does SCILLC assume any liability arising out of the application or use of any product or circuit, and specifically disclaims any and all liability, including without limitation special, consequential or incidental damages. "Typical" parameters which may be provided in SCILLC data sheets and/or specifications can and do vary in different applications and actual performance may vary over time. All operating parameters, including "Typicals" must be validated for each customer application by customer's technical experts. SCILLC does not convey any license under its patent rights nor the rights of others. SCILLC products are not designed, intended, or authorized for use as components in systems intended for surgical implant into the body, or other applications intended to support or sustain life, or for any other application in which the failure of the SCILLC product could create a situation where personal injury or death may occur. Should Buyer purchase or use SCILLC products for any such unintended or unauthorized application, Buyer shall indemnify and hold SCILLC and its officers, employees, subsidiaries, affiliates, and distributors harmless against all claims, costs, damages, and expenses, and reasonable attorney fees arising out of, directly or indirectly, any claim of personal injury or death associated with such unintended or unauthorized use, even if such claim alleges that SCILLC was negligent regarding the design or manufacture of the part. SCILLC is an Equal Opportunity/Affirmative Action Employer. This literature is subject to all applicable copyright laws and is not for resale in any manner.

## PUBLICATION ORDERING INFORMATION

### LITERATURE FULFILLMENT:

Literature Distribution Center for ON Semiconductor  
P.O. Box 61312, Phoenix, Arizona 85082-1312 USA  
**Phone:** 480-829-7710 or 800-344-3860 Toll Free USA/Canada  
**Fax:** 480-829-7709 or 800-344-3867 Toll Free USA/Canada  
**Email:** [orderlit@onsemi.com](mailto:orderlit@onsemi.com)

**N. American Technical Support:** 800-282-9855 Toll Free  
USA/Canada

**Japan:** ON Semiconductor, Japan Customer Focus Center  
2-9-1 Kamimeguro, Meguro-ku, Tokyo, Japan 153-0051  
**Phone:** 81-3-5773-3850

**ON Semiconductor Website:** <http://onsemi.com>

**Order Literature:** <http://www.onsemi.com/litorder>

For additional information, please contact your local Sales Representative.