

DUAL DIFFERENTIAL PECL DRIVER/RECEIVER

FEATURES

- **Functional Replacement for the Agere BTF1A**
- **Driver Features**
 - Third-State Logic Low Output
 - ESD Protection HBM > 3 kV, CDM > 2 kV
 - No Line Loading when $V_{CC} = 0$
 - Capable of Driving 50-Ω loads
 - 2.0-ns Maximum Propagation Delay
 - 0.2-ns Output Skew (typical)
- **Receiver Features**
 - High-Input Impedance Approximately 8 kΩ
 - 4.0-ns Maximum Propagation Delay
 - 50-mV Hysteresis
 - Slew Rate Limited (1 ns min 80% to 20%)
 - ESD Protection HBM > 3 kV, CDM > 2 kV
 - -1.1-V to 7.1-V Input Voltage Range
- **Common Device Features**
 - Common Enable for Each Driver/Receiver Pair
 - Operating Temperature Range: -40°C to 85°C
 - Single 5.0 V ± 10% Supply
 - Available in Gull-Wing SOIC (JEDEC MS-013, DW) and SOIC (D) Package

DESCRIPTION

The TB5T1 device is a dual differential driver/receiver circuit that transmits and receives digital data over balanced transmission lines. The dual drivers translate input TTL logic levels to differential pseudo-ECL output levels. The dual receivers convert differential-input logic levels to TTL output levels. Each driver or receiver pair has its own common enable control allowing serial data and a control clock to be transmitted and received on a single integrated circuit. The TB5T1 requires the customer to supply termination resistors on the circuit board.

The power-down loading characteristics of the receiver input circuit are approximately 8 kΩ relative to the power supplies; hence, it does not load the transmission line when the circuit is powered down.

In circuits with termination resistors, the line remains impedance-matched when the circuit is powered down. The driver does not load the line when it is powered down.

All devices are characterized for operation from -40°C to 85°C.

The logic inputs of this device include internal pull-up resistors of approximately 40 kΩ that are connected to V_{CC} to ensure a logical high level input if the inputs are open circuited.

PIN ASSIGNMENTS
DW AND D PACKAGE
(TOP VIEW)

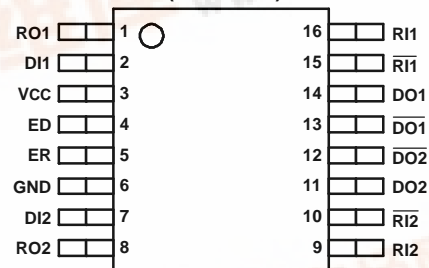

FUNCTIONAL BLOCK DIAGRAM

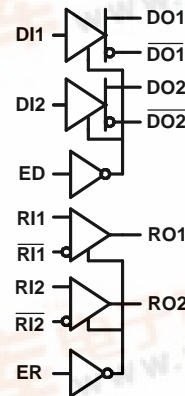

ENABLE TRUTH TABLE

ED	ER	D1	D2	R1	R2
0	0	Active	Active	Active	Active
1	0	Disabled	Disabled	Active	Active
0	1	Active	Active	Disabled	Disabled
1	1	Disabled	Disabled	Disabled	Disabled



These devices have limited built-in ESD protection. The leads should be shorted together or the device placed in conductive foam during storage or handling to prevent electrostatic damage to the MOS gates.

ORDERING INFORMATION

PART NUMBER	PART MARKING	PACKAGE	LEAD FINISH	STATUS
TB5T1DW	TB5T1	Gull-Wing SOIC	NiPdAu	Production
TB5T1D	TB5T1	SOIC	NiPdAu	Production
TB5T1LDW	TB5T1L	Gull-Wing SOIC	SnPb	Production
TB5T1LD	TB5T1L	SOIC	SnPb	Production

POWER DISSIPATION RATINGS

PACK- AGE	CIRCUIT BOARD MODEL	POWER RATING	THERMAL RESISTANCE, JUNCTION- TO-AMBIENT WITH NO AIR FLOW	DERATING FACTOR ⁽¹⁾	POWER RATING
		$T_A \leq 25^\circ\text{C}$		$T_A \geq 25^\circ\text{C}$	$T_A = 85^\circ\text{C}$
D	Low-K ⁽²⁾	752 mW	132.8°C/W	7.5 mW/°C	301 mW
	High-K ⁽³⁾	1160 mW	85.8°C/W	11.7 mW/°C	466 mW
DW	Low-K ⁽²⁾	814 mW	122.7°C/W	8.2 mW/°C	325 mW
	High-K ⁽³⁾	1200 mW	83.1°C/W	12 mW/°C	481 mW

(1) This is the inverse of the junction-to-ambient thermal resistance when board-mounted with no airflow.

(2) In accordance with the low-K thermal metric definitions of EIA/JESD51-3.

(3) In accordance with the high-K thermal metric definitions of EIA/JESD51-7.

THERMAL CHARACTERISTICS

PARAMETER		PACKAGE	VALUE	UNIT
θ_{JB}	Junction-to-board thermal resistance	D	48.4	°C/W
		DW	55.2	°C/W
θ_{JC}	Junction-to-case thermal resistance	D	45.1	°C/W
		DW	48.1	°C/W

ABSOLUTE MAXIMUM RATINGS

over operating free-air temperature range unless otherwise noted⁽¹⁾

		UNIT
Supply voltage, V_{CC}		0 V to 6 V
Magnitude of differential bus (input) voltage, $ V_{R11} - V_{R11} $, $ V_{R12} - V_{R12} $		8.4 V
ESD	Human Body Model ⁽²⁾	All pins ± 3 kV
	Charged-Device Model ⁽³⁾	All pins ± 2 kV
Continuous power dissipation		See Dissipation Rating Table
Storage temperature, T_{stg}		-65°C to 150°C

(1) Stresses beyond those listed under "absolute maximum ratings" may cause permanent damage to the device. These are stress ratings only, and functional operation of the device at these or any other conditions beyond those indicated under "recommended operating conditions" is not implied. Exposure to absolute-maximum-rated conditions for extended periods may affect device reliability.

(2) Tested in accordance with JEDEC Standard 22, Test Method A114-A.

(3) Tested in accordance with JEDEC Standard 22, Test Method C101.

RECOMMENDED OPERATING CONDITIONS

	MIN	NOM	MAX	UNIT
Supply voltage, V_{CC}	4.5	5	5.5	V
Bus pin input voltage, V_{R11} , V_{R11} , V_{R12} , or V_{R12}	-1.2 ⁽¹⁾		7.2	V
Magnitude of differential input voltage, $ V_{R11} - V_{R11} $, $ V_{R12} - V_{R12} $	0.1		6	V
Operating free-air temperature, T_A	-40		85	°C

(1) The algebraic convention, in which the least positive (most negative) limit is designated as minimum is used in this data sheet, unless otherwise noted.

ELECTRICAL CHARACTERISTICS

over operating free-air temperature range unless otherwise noted

PARAMETER		TEST CONDITIONS	MIN	TYP	MAX	UNIT
I_{CC}	Supply current	Outputs disabled			40	mA
		Outputs enabled			40	mA

THIRD STATE

A TB5T1 driver produces pseudo-ECL levels and has a third state mode, which is different from a conventional TTL device. When a TB5T1 driver is placed in the third state, the base of the output transistors are pulled low, bringing the outputs below the active-low level of standard PECL devices. (For example: The TB5T1 low output level is typically 2.7 V, while the third state noninverting output level is typically 1.2 V.) In a bidirectional, multipoint bus application, the driver of one device, which is in its third state, can be back driven by another driver on the bus whose voltage in the low state is lower than the 3-stated device. This could be due to differences between individual driver's power supplies. In this case, the device in the third state controls the line, thus clamping the line and reducing the signal swing. If the difference between the driver power supplies is small, this consideration can be ignored. Again using the TB5T1 driver as an example, a typical supply voltage difference between separate drivers of > 2 V can exist without significantly affecting the amplitude of the signal.

DRIVER ELECTRICAL CHARACTERISTICS

over operating free-air temperature range unless otherwise noted

PARAMETER		TEST CONDITIONS	MIN	TYP	MAX	UNIT
V_{OH}	Output high voltage ⁽¹⁾		$V_{CC} - 1.8$	$V_{CC} - 1.3$	$V_{CC} - 0.8$	V
V_{OL}	Output low voltage ⁽¹⁾		$V_{OH} - 1.4$	$V_{OH} - 1.2$	$V_{OH} - 0.7$	V
V_{OD}	Differential output voltage, $ V_{OH} - V_{OL} $		0.7	1.1	1.4	V
V_{OH}	Output high voltage ⁽¹⁾	$T_A = 0^\circ\text{C to } 85^\circ\text{C}$	$V_{CC} - 1.8$	$V_{CC} - 1.3$	$V_{CC} - 0.8$	V
V_{OL}	Output low voltage ⁽¹⁾		$V_{OH} - 1.4$	$V_{OH} - 1.1$	$V_{OH} - 0.5$	V
V_{OD}	Differential output voltage, $ V_{OH} - V_{OL} $		0.5	1.1	1.4	V
$V_{OC(PP)}$	Peak-to-peak common-mode output voltage	$C_L = 5 \text{ pF}$, See Figure 7		230	600	mV
V_{OZH}	Third state output high voltage ⁽¹⁾	$V_{CC} = 4.5 \text{ V}$	1.4	1.8	2.2	V
V_{OZD}	Third state differential output voltage ⁽¹⁾					
V_{IL}	Input low voltage ⁽³⁾	$V_{CC} = 5.5 \text{ V}$			0.8	V
V_{IH}	Input high voltage	$V_{CC} = 4.5 \text{ V}$	2			V
V_{IK}	Input clamp voltage	$V_{CC} = 4.5 \text{ V}$, $I_I = -5 \text{ mA}$			-1 ⁽²⁾	V
I_{OS}	Short-circuit output current ⁽⁴⁾	$V_{CC} = 5.5 \text{ V}$, $V_O = 0 \text{ V}$			-250 ⁽²⁾	mA
		$V_{CC} = 5.5 \text{ V}$, $V_{OD} = 0 \text{ V}$			± 10 ⁽²⁾	mA
I_{IL}	Input low current	$V_{CC} = 5.5 \text{ V}$, $V_I = 0.4 \text{ V}$			-400 ⁽²⁾	μA
I_{IH}	Input high current	$V_{CC} = 5.5 \text{ V}$, $V_I = 2.7 \text{ V}$			20	μA
I_{IH}	Input reverse current	$V_{CC} = 5.5 \text{ V}$, $V_I = 5.5 \text{ V}$			100	μA
C_{IN}	Input Capacitance			5		pF

(1) Values are with terminations as per Figure 6.

(2) This parameter is listed using a magnitude and polarity/direction convention, rather than an algebraic convention, to match the original Agere data sheet.

(3) The input levels and difference voltage provide no noise immunity and should be tested only in a static, noise-free environment.

(4) Test must be performed one lead at a time to prevent damage to the device. No test circuit attached.

RECEIVER ELECTRICAL CHARACTERISTICS

over operating free-air temperature range unless otherwise noted

PARAMETER		TEST CONDITIONS	MIN	TYP	MAX	UNIT
V _{OL}	Output low voltage	V _{CC} = 4.5 V, I _{OL} = 8.0 mA			0.4	V
V _{OH}	Output high voltage	V _{CC} = 4.5 V, I _{OH} = -400 μA	2.4			V
V _{IL}	Enable input low voltage ⁽¹⁾	V _{CC} = 5.5 V			0.8	V
V _{IH}	Enable input high voltage ⁽¹⁾	V _{CC} = 4.5 V	2			V
V _{IK}	Enable input clamp voltage	V _{CC} = 4.5 V, I _I = -5 mA			-1 ⁽²⁾	V
V _{TH+}	Positive-going differential input threshold voltage ⁽¹⁾	V _{Rin} - V _{Rin}			100	mV
V _{TH-}	Negative-going differential input threshold voltage ⁽¹⁾	V _{Rin} - V _{Rin}			-100 ⁽²⁾	mV
V _{HYST}	Differential input threshold voltage hysteresis	(V _{TH+} - V _{TH-})		50		mV
I _{OZL}	Off-state output low current (high Z)	V _{CC} = 5.5 V, V _O = 0.4 V			-20 ⁽²⁾	μA
I _{OZH}	Off-state output high current (high Z)	V _{CC} = 5.5 V, V _O = 2.4 V			20	μA
I _{OS}	Short circuit output current ⁽³⁾	V _{CC} = 5.5 V			-100 ⁽²⁾	mA
I _{IL}	Enable input low current	V _{CC} = 5.5 V, V _{IN} = 0.4 V			-400 ⁽²⁾	μA
I _{IH}	Enable input high current	V _{CC} = 5.5 V, V _{IN} = 2.7 V			20	μA
I _{IH}	Enable input reverse current	V _{CC} = 5.5 V, V _{IN} = 5.5 V			100	μA
I _{IL}	Differential input low current	V _{CC} = 5.5 V, V _{IN} = -1.2 V			-2 ⁽²⁾	mA
I _{IH}	Differential input high current	V _{CC} = 5.5 V, V _{IN} = 7.2 V			1	mA
R _O	Output resistance			20		Ω

(1) The input levels and difference voltage provide no noise immunity and should be tested only in a static, noise-free environment.

(2) This parameter is listed using a magnitude and polarity/direction convention, rather than an algebraic convention, to match the original Agere data sheet.

(3) Test must be performed one lead at a time to prevent damage to the device.

DRIVER SWITCHING CHARACTERISTICS

over operating free-air temperature range unless otherwise noted

PARAMETER		TEST CONDITIONS	MIN	TYP	MAX	UNIT
t _{P1}	Propagation delay time, input high to output ⁽¹⁾	C _L = 5 pF, See Figure 2 and Figure 6		1.2	2	ns
t _{P2}	Propagation delay time, input low to output ⁽¹⁾			1.2	2	ns
Δt _P	Capacitive delay			0.01	0.03	ns/pF
t _{PHZ}	Propagation delay time, high-level-to-high-impedance output	C _L = 5 pF, See Figure 3 and Figure 6		8	12	ns
t _{PLZ}	Propagation delay time, low-level-to-high-impedance output			7	12	ns
t _{PZH}	Propagation delay time, high-impedance-to-high-level output			4	12	ns
t _{PZL}	Propagation delay time, high-impedance-to-low-level output			5	12	ns
t _{skew1}	Output skew, t _{P1} - t _{P2}	C _L = 5 pF, See Figure 2 and Figure 6		0.15	0.3	ns
t _{skew2}	Output skew, t _{PHH} - t _{PHL} , t _{PLH} - t _{PLL}			0.15	1.1	ns
t _{skew(pp)}	Part-to-part skew ⁽²⁾			0.1	1	ns
Δt _{skew}	Output skew, difference between drivers				0.3	ns
t _{TLH}	Rise time (20%-80%)			0.7	2	ns
t _{THL}	Fall time (80%-20%)			0.7	2	ns

(1) Parameters t_{P1} and t_{P2} are measured from the 1.5 V point of the input to the crossover point of the outputs (see Figure 2).

(2) t_{skew(pp)} is the magnitude of the difference in propagation delay times between any specified outputs of two devices when both devices operate with the same supply voltage, at the same temperature, and have identical packages and test circuits.

RECEIVER SWITCHING CHARACTERISTICS

over operating free-air temperature range unless otherwise noted

PARAMETER		TEST CONDITIONS	MIN	TYP	MAX	UNIT
t_{PLH}	Propagation delay time, low-to-high-level output	$C_L = 0 \text{ pF}^{(1)}$, See Figure 4 and Figure 8		2.5	4	ns
t_{PHL}	Propagation delay time, high-to-low-level output			2.5	4	
t_{PLH}	Propagation delay time, low-to-high-level output	$C_L = 15 \text{ pF}$, See Figure 4 and Figure 8		3	5.5	ns
t_{PHL}	Propagation delay time, high-to-low-level output			3	5.5	
t_{PHZ}	Propagation delay time, high-level-to-high-impedance output	$C_L = 5 \text{ pF}$, See Figure 5 and Figure 9		6	12	ns
t_{PLZ}	Propagation delay time, low-level-to-high-impedance output			6	12	
t_{skew1}	Pulse width distortion, $ t_{PHL} - t_{PLH} $	Load capacitance (C_L) = 10 pF, See Figure 4 and Figure 8			0.7	ns
		Load capacitance (C_L) = 150 pF, See Figure 4 and Figure 8			4	ns
$\Delta t_{skew1p-p}$	Part-to-part output waveform skew ⁽²⁾	$C_L = 10 \text{ pF}$, $T_A = 75^\circ\text{C}$, See Figure 4 and Figure 8		0.8	1.4	ns
		$C_L = 10 \text{ pF}$, $T_A = -40^\circ\text{C}$ to 85°C , See Figure 4 and Figure 8			1.5	ns
Δt_{skew}	Same part output waveform skew ⁽²⁾	$C_L = 10 \text{ pF}$, See Figure 4 and Figure 8			0.3	ns
t_{PZH}	Propagation delay time, high-impedance-to-high-level output	$C_L = 10 \text{ pF}$, See Figure 5 and Figure 8		3	12	ns
t_{PZL}	Propagation delay time, high-impedance-to-low-level output			4	12	
t_{TLH}	Rise time (20%—80%)	$C_L = 10 \text{ pF}$, See Figure 5 and Figure 8	1		4	ns
t_{THL}	Fall time (80%—20%)		1		4	

- (1) The propagation delay values with a 0 pF load are based on design and simulation.
- (2) Output waveform skews are when devices operate with the same supply voltage, same temperature, have the same packages and the same test circuits.

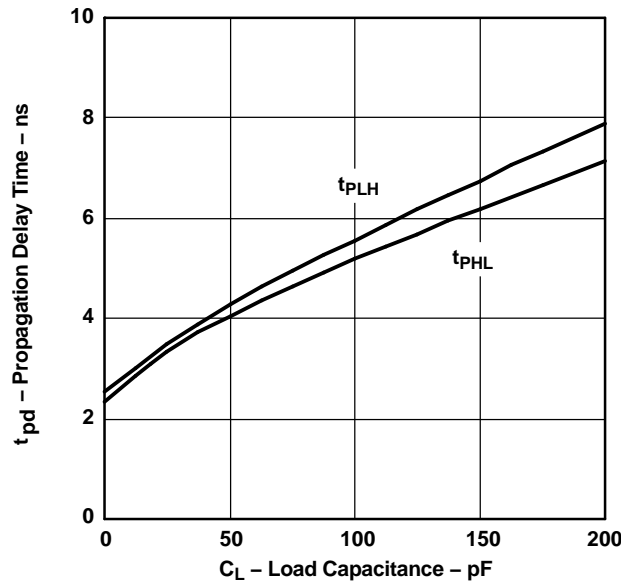

NOTE: This graph is included as an aid to the system designers. Total circuit delay varies with load capacitance. The total delay is the sum of the delay due to external capacitance and the intrinsic delay of the device. Intrinsic delay is listed in the table above as the 0 pF load condition. The incremental increase in delay between the 0 pF load condition and the actual total load capacitance represents the extrinsic, or external delay contributed by the load.

Figure 1. Typical Propagation Delay vs Load Capacitance at 25°C

PARAMETER MEASUREMENT INFORMATION

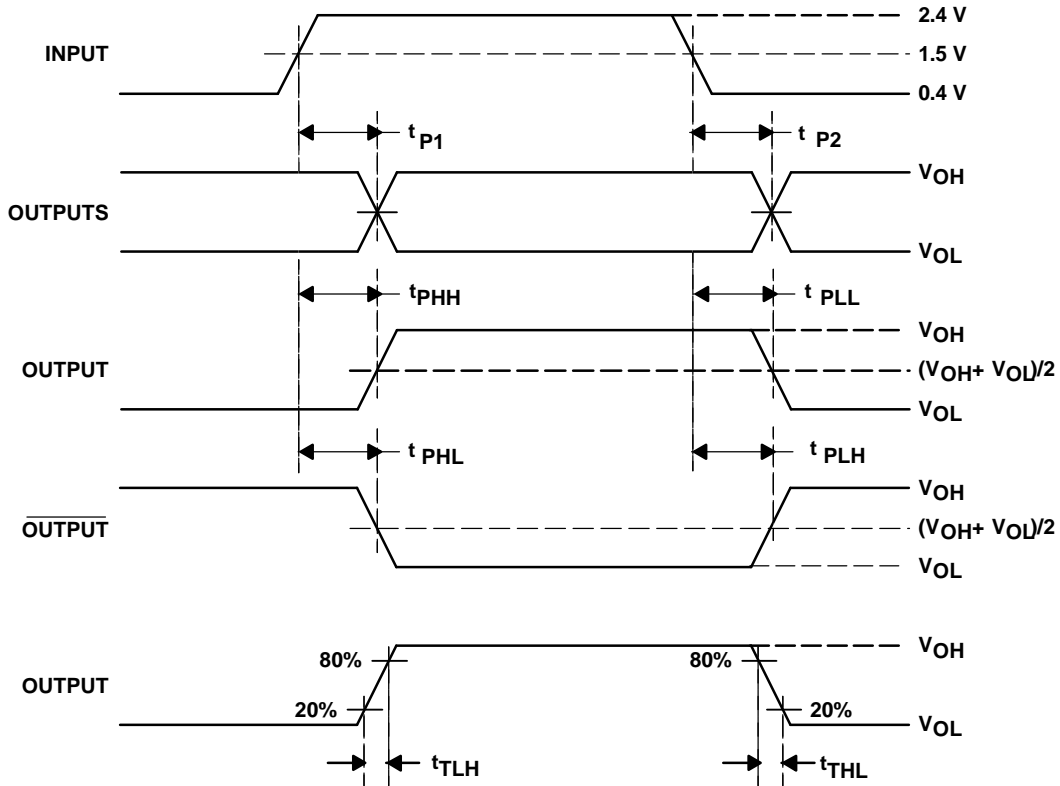
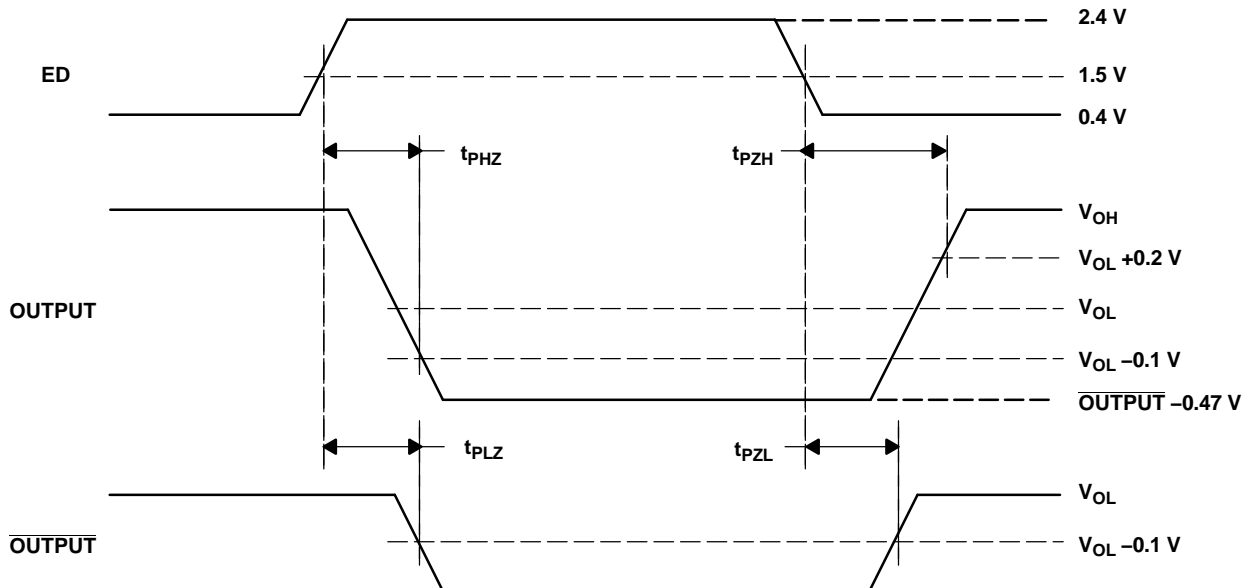

Figure 2. Driver Propagation Delay Times



A. NOTE: In the third state, OUTPUT is 0.47 V (minimum) more negative than $\overline{\text{OUTPUT}}$.

Figure 3. Driver Enable and Disable Delay Times for a High Input

PARAMETER MEASUREMENT INFORMATION (continued)

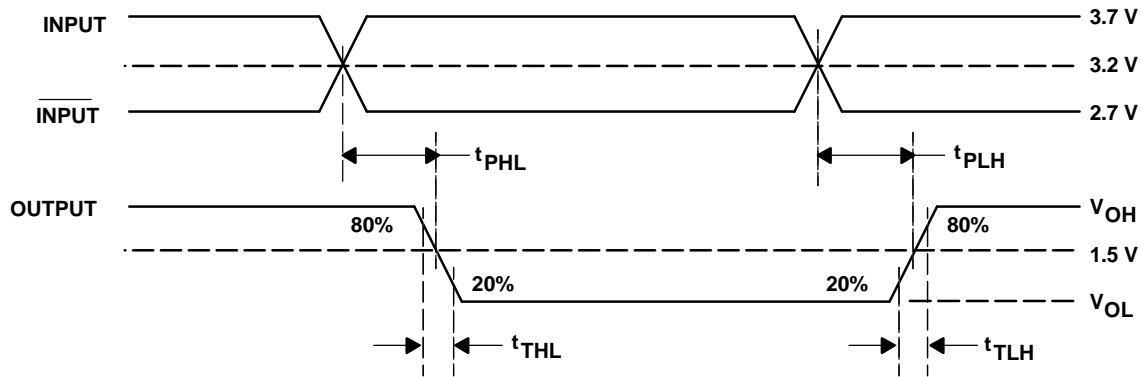

Figure 4. Receiver Propagation Delay Times

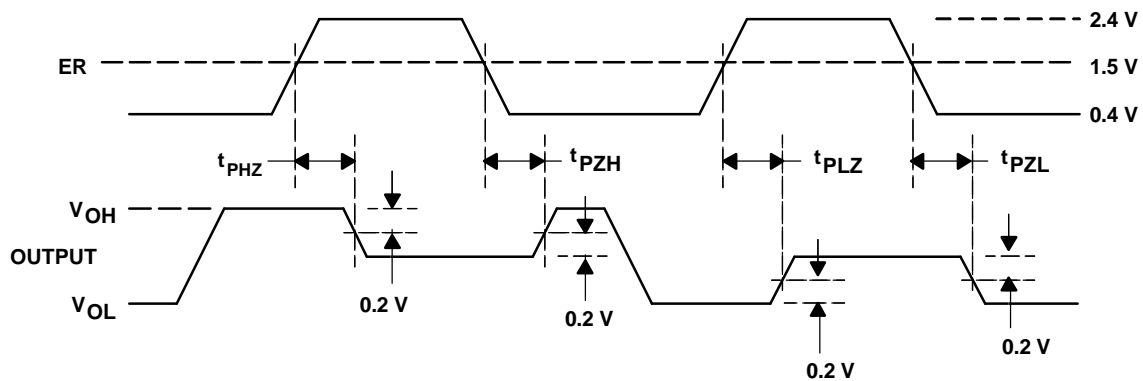

Figure 5. Receiver Enable and Disable Timing

Parametric values specified under the Electrical Characteristics and Timing Characteristics sections for the data transmission driver devices are measured with the following output load circuits.

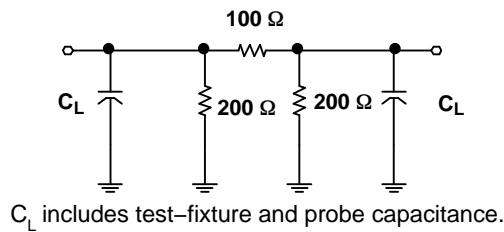
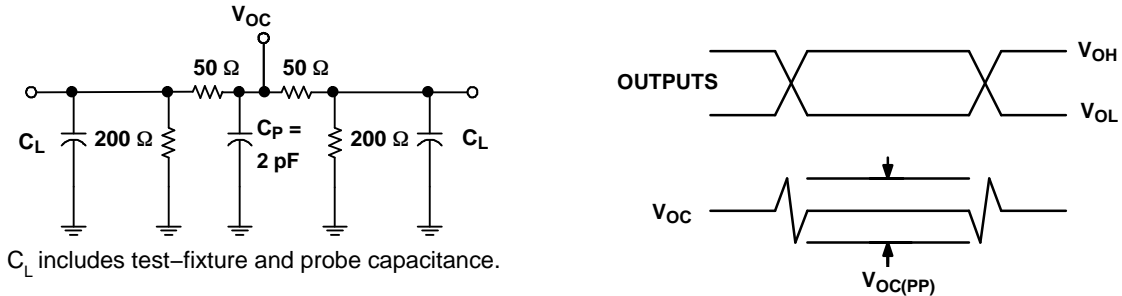

Figure 6. Driver Test Circuit

PARAMETER MEASUREMENT INFORMATION (continued)



C_L includes test-fixture and probe capacitance.

- A. NOTE: All input pulses are supplied by a generator having the following characteristics: t_r or $t_f = 1$ ns, pulse repetition rate (PRR) = 0.25 Mbps, pulse width = 500 ± 10 ns. C_p includes the instrumentation and fixture capacitance within 0,06 m of the D.U.T. The measurement of $V_{OS(PP)}$ is made on test equipment with a -3 dB bandwidth of at least 1 GHz.

Figure 7. Test Circuit and Definitions for the Driver Common-Mode Output Voltage

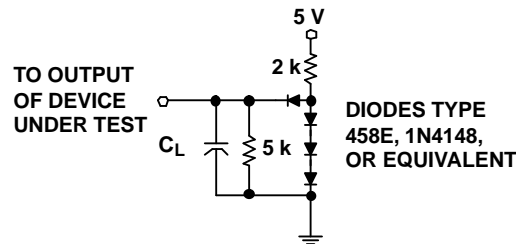

Figure 8. Receiver Propagation Delay Time and Enable Time (t_{PZH} , t_{PZL}) Test Circuit

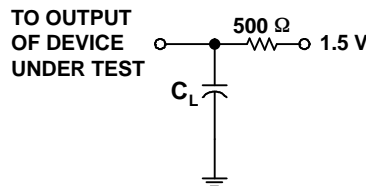
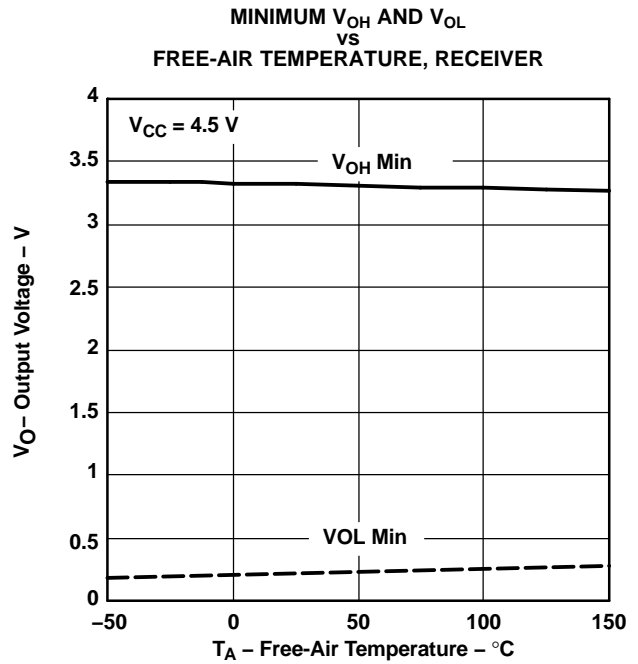
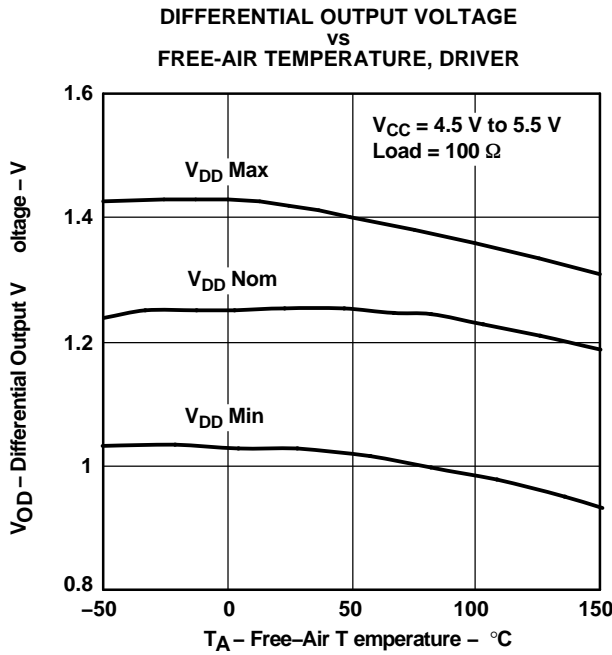
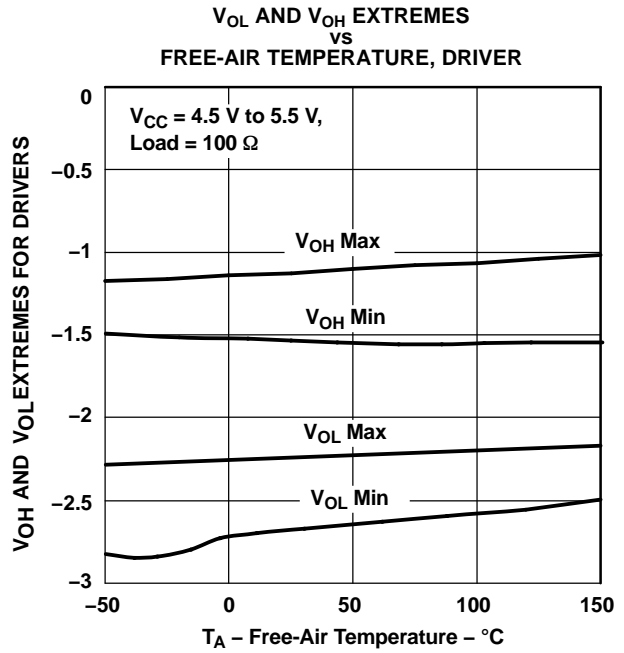
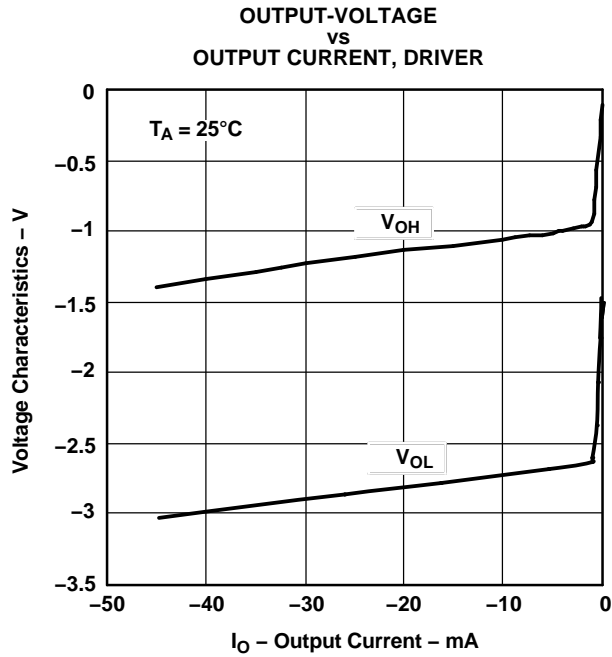

Figure 9. Receiver Disable Time (t_{PHZ} , t_{PLZ}) Test Circuit

TYPICAL CHARACTERISTICS



TYPICAL CHARACTERISTICS (continued)

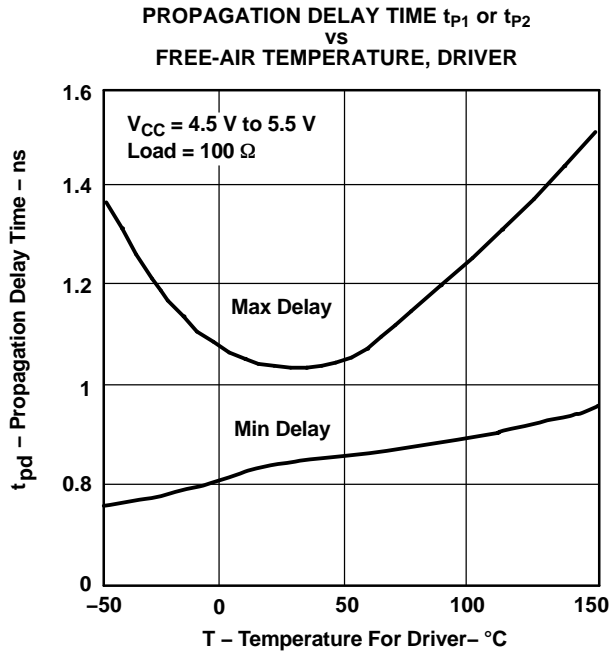

Figure 14.

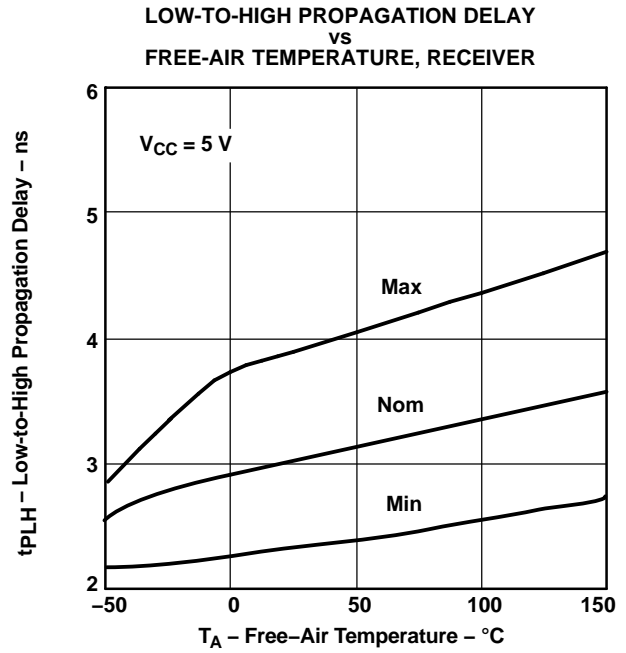

Figure 15.

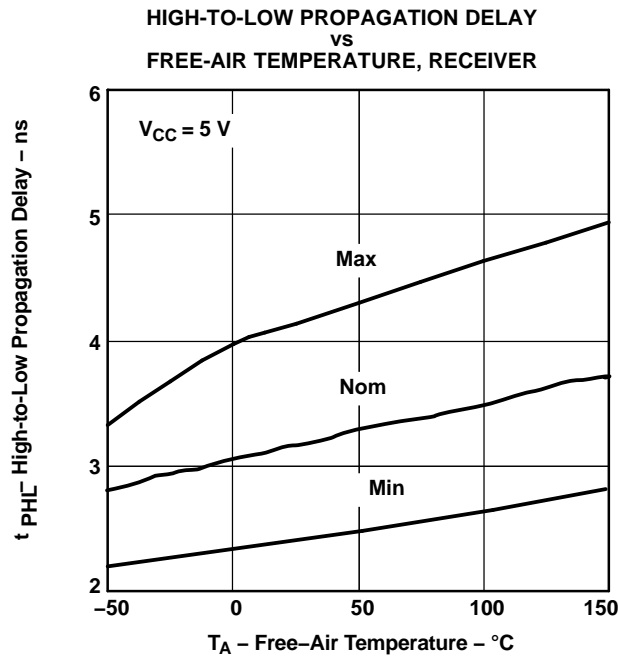

Figure 16.

APPLICATION INFORMATION

Power Dissipation

The power dissipation rating, often listed as the package dissipation rating, is a function of the ambient temperature, T_A , and the airflow around the device. This rating correlates with the device's maximum junction temperature, sometimes listed in the absolute maximum ratings tables. The maximum junction temperature accounts for the processes and materials used to fabricate and package the device, in addition to the desired life expectancy.

There are two common approaches to estimating the internal die junction temperature, T_J . In both of these methods, the device internal power dissipation P_D needs to be calculated. This is done by totaling the supply power(s) to arrive at the system power dissipation:

$$\sum (V_{Sn} \times I_{Sn})$$

and then subtracting the total power dissipation of the external load(s):

$$\sum (V_{Ln} \times I_{Ln})$$

The first T_J calculation uses the power dissipation and ambient temperature, along with one parameter: θ_{JA} , the junction-to-ambient thermal resistance, in degrees Celsius per watt.

The product of P_D and θ_{JA} is the junction temperature rise above the ambient temperature. Therefore:

$$T_J = T_A + (P_D \times \theta_{JA})$$

Note that θ_{JA} is highly dependent on the PCB on which the device is mounted and on the airflow over the device and PCB. JEDEC/EIA has defined standardized test conditions for measuring θ_{JA} . Two commonly used conditions are the low-K and the high-K boards, covered by EIA/JESD51-3 and EIA/JESD51-7 respectively. Figure 17 shows the low-K and high-K values of θ_{JA} versus air flow for this device and its package options.

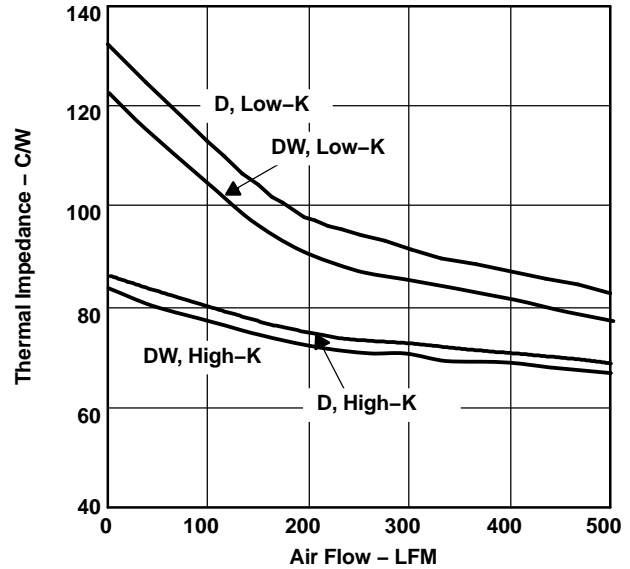

Figure 17. Thermal Impedance vs Air Flow

The standardized θ_{JA} values may not accurately represent the conditions under which the device is used. This can be due to adjacent devices acting as heat sources or heat sinks, to nonuniform airflow, or to the system PCB having significantly different thermal characteristics than the standardized test PCBs. The second method of system thermal analysis is more accurate. This calculation uses the power dissipation and ambient temperature, along with two device and two system-level parameters:

- θ_{JC} , the junction-to-case thermal resistance, in degrees Celsius per watt
- θ_{JB} , the junction-to-board thermal resistance, in degrees Celsius per watt
- θ_{CA} , the case-to-ambient thermal resistance, in degrees Celsius per watt
- θ_{BA} , the board-to-ambient thermal resistance, in degrees Celsius per watt.

In this analysis, there are two parallel paths, one through the case (package) to the ambient, and another through the device to the PCB to the ambient. The system-level junction-to-ambient thermal impedance, $\theta_{JA(S)}$, is the equivalent parallel impedance of the two parallel paths:

$$T_J = T_A + (P_D \times \theta_{JA(S)})$$

where

$$\theta_{JA(S)} = \frac{[(\theta_{JC} + \theta_{CA}) \times (\theta_{JB} + \theta_{BA})]}{(\theta_{JC} + \theta_{CA} + \theta_{JB} + \theta_{BA})}$$

Load Circuits

The test load circuits shown in Figure 6 and Figure 7 are based on a recommended *pi* type of load circuit shown in Figure 18. The 100- Ω differential load resistor R_T at the receiver provide proper termination for the interconnecting transmission line, assuming it has a 100- Ω characteristic impedance. The two resistors R_S to ground at the driver end of the transmission line link provide dc current paths for the emitter follower output transistors. The two resistors to ground normally should not be placed at the receiver end, as they shunt the termination resistor, potentially creating an impedance mismatch with undesirable reflections.

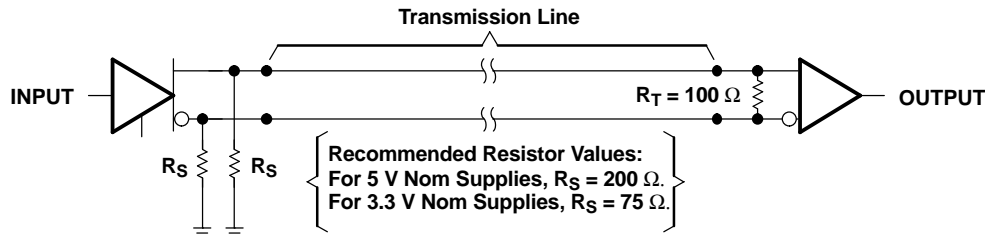

Figure 18. A Recommended *pi* Load Circuit

Another common load circuit, a Y load, is shown in Figure 19. The receiver-end line termination of R_T is provided by the series combination of the two $R_{T/2}$ resistors, while the dc current path to ground is provided by the single resistor R_S . Recommended values, as a function of the nominal supply voltage range, are indicated in the figure.

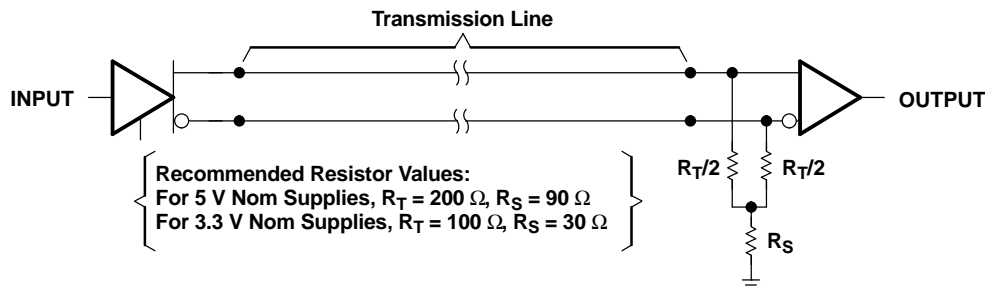

Figure 19. A Recommended Y Load Circuit

An additional load circuit, similar to one commonly used with ECL and PECL, is shown in Figure 20.

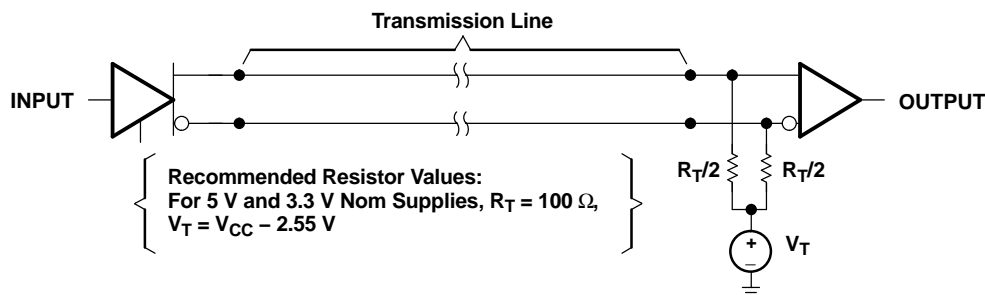

Figure 20. A Recommended PECL-Style Load Circuit

An important feature of all of these recommended load circuits is that they ensure that both of the emitter follower output transistors remain active (conducting current) at all times. When deviating from these recommended values, it is important to make sure that the low-side output transistor does not turn off. Failure to do so increases the t_{skew2} and $V_{OC(PP)}$ values, increasing the potential for electromagnetic radiation.

PACKAGING INFORMATION

Orderable Device	Status ⁽¹⁾	Package Type	Package Drawing	Pins	Package Qty	Eco Plan ⁽²⁾	Lead/Ball Finish	MSL Peak Temp ⁽³⁾
TB5T1D	ACTIVE	SOIC	D	16	40	Pb-Free (RoHS)	CU NIPDAU	Level-2-250C-1YEAR/ Level-1-220C-UNLIM
TB5T1DR	ACTIVE	SOIC	D	16	2500	Pb-Free (RoHS)	CU NIPDAU	Level-2-250C-1YEAR/ Level-1-220C-UNLIM
TB5T1DW	ACTIVE	SOIC	DW	16	40	Pb-Free (RoHS)	CU NIPDAU	Level-2-250C-1YEAR/ Level-1-220C-UNLIM
TB5T1DWR	ACTIVE	SOIC	DW	16	2000	Pb-Free (RoHS)	CU NIPDAU	Level-2-250C-1YEAR/ Level-1-220C-UNLIM

⁽¹⁾ The marketing status values are defined as follows:

ACTIVE: Product device recommended for new designs.

LIFEBUY: TI has announced that the device will be discontinued, and a lifetime-buy period is in effect.

NRND: Not recommended for new designs. Device is in production to support existing customers, but TI does not recommend using this part in a new design.

PREVIEW: Device has been announced but is not in production. Samples may or may not be available.

OBSOLETE: TI has discontinued the production of the device.

⁽²⁾ Eco Plan - The planned eco-friendly classification: Pb-Free (RoHS) or Green (RoHS & no Sb/Br) - please check <http://www.ti.com/productcontent> for the latest availability information and additional product content details.

TBD: The Pb-Free/Green conversion plan has not been defined.

Pb-Free (RoHS): TI's terms "Lead-Free" or "Pb-Free" mean semiconductor products that are compatible with the current RoHS requirements for all 6 substances, including the requirement that lead not exceed 0.1% by weight in homogeneous materials. Where designed to be soldered at high temperatures, TI Pb-Free products are suitable for use in specified lead-free processes.

Green (RoHS & no Sb/Br): TI defines "Green" to mean Pb-Free (RoHS compatible), and free of Bromine (Br) and Antimony (Sb) based flame retardants (Br or Sb do not exceed 0.1% by weight in homogeneous material)

⁽³⁾ MSL, Peak Temp. -- The Moisture Sensitivity Level rating according to the JEDEC industry standard classifications, and peak solder temperature.

Important Information and Disclaimer:The information provided on this page represents TI's knowledge and belief as of the date that it is provided. TI bases its knowledge and belief on information provided by third parties, and makes no representation or warranty as to the accuracy of such information. Efforts are underway to better integrate information from third parties. TI has taken and continues to take reasonable steps to provide representative and accurate information but may not have conducted destructive testing or chemical analysis on incoming materials and chemicals. TI and TI suppliers consider certain information to be proprietary, and thus CAS numbers and other limited information may not be available for release.

In no event shall TI's liability arising out of such information exceed the total purchase price of the TI part(s) at issue in this document sold by TI to Customer on an annual basis.

MECHANICAL DATA

D (R-PDSO-G16)

PLASTIC SMALL-OUTLINE PACKAGE

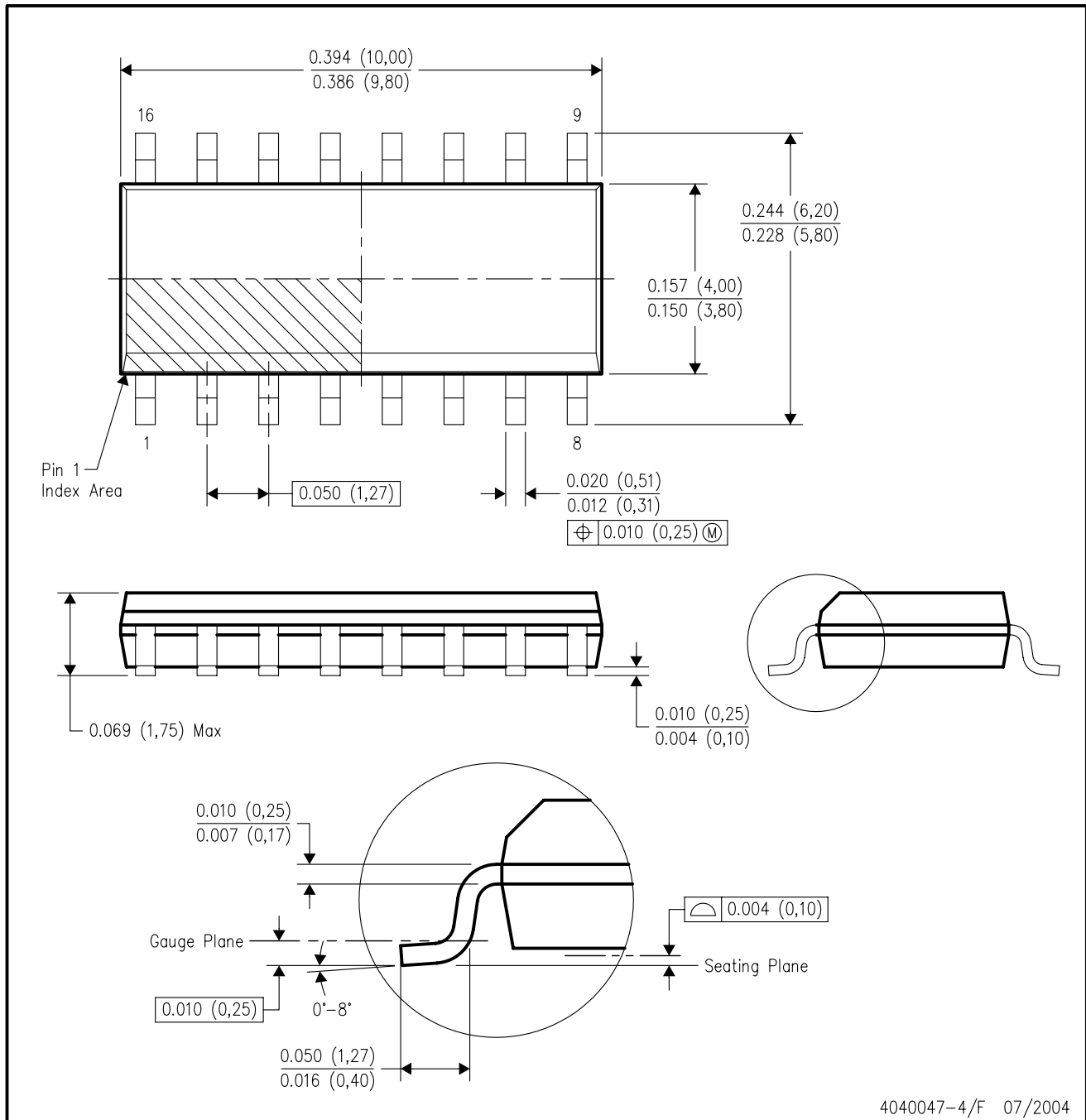

- NOTES:
- All linear dimensions are in inches (millimeters).
 - This drawing is subject to change without notice.
 - Body dimensions do not include mold flash or protrusion not to exceed 0.006 (0,15).
 - Falls within JEDEC MS-012 variation AC.

DW (R-PDSO-G16)

PLASTIC SMALL-OUTLINE PACKAGE

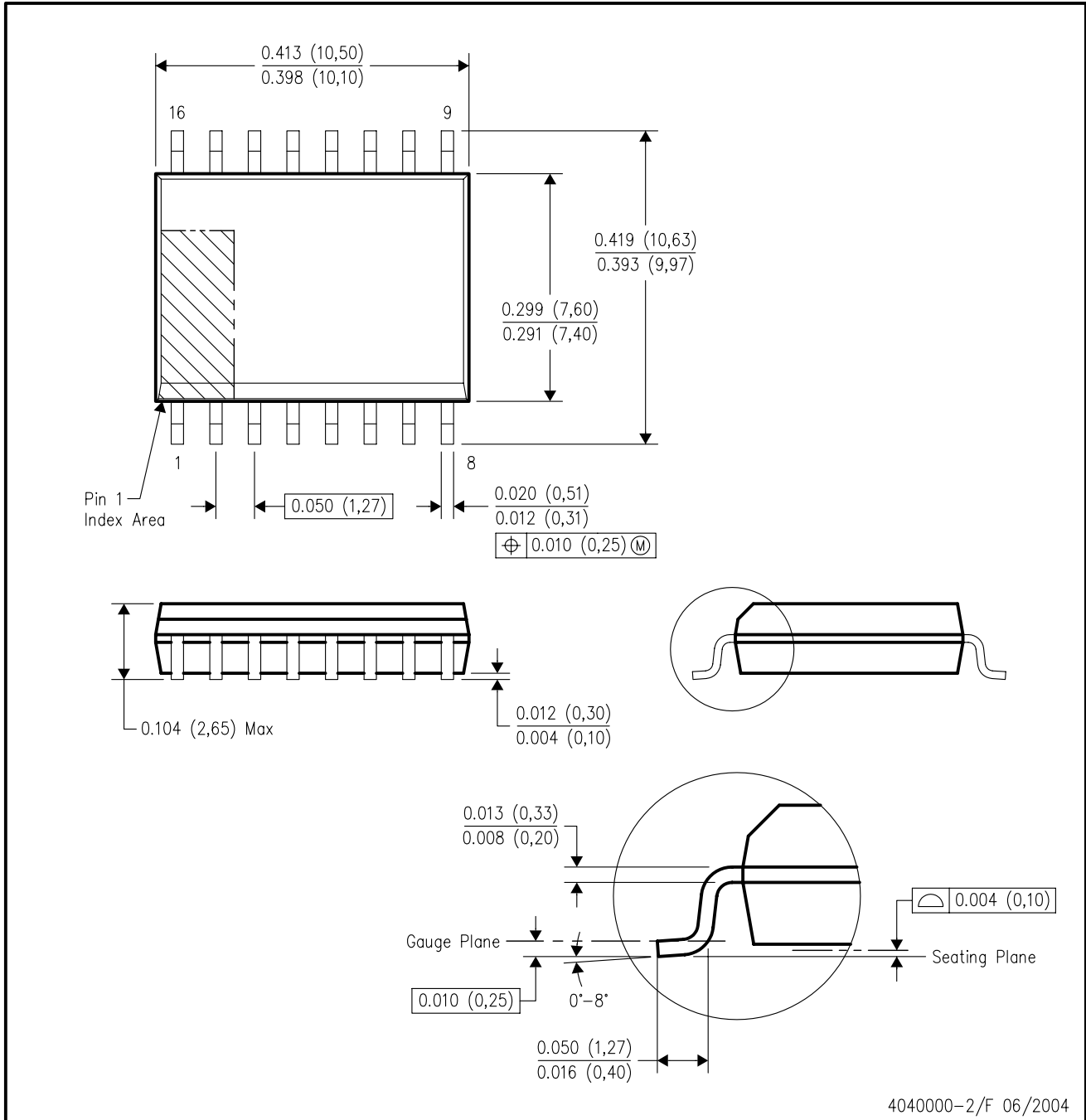

4040000-2/F 06/2004

- NOTES:
- A. All linear dimensions are in inches (millimeters).
 - B. This drawing is subject to change without notice.
 - C. Body dimensions do not include mold flash or protrusion not to exceed 0.006 (0,15).
 - D. Falls within JEDEC MS-013 variation AA.

IMPORTANT NOTICE

Texas Instruments Incorporated and its subsidiaries (TI) reserve the right to make corrections, modifications, enhancements, improvements, and other changes to its products and services at any time and to discontinue any product or service without notice. Customers should obtain the latest relevant information before placing orders and should verify that such information is current and complete. All products are sold subject to TI's terms and conditions of sale supplied at the time of order acknowledgment.

TI warrants performance of its hardware products to the specifications applicable at the time of sale in accordance with TI's standard warranty. Testing and other quality control techniques are used to the extent TI deems necessary to support this warranty. Except where mandated by government requirements, testing of all parameters of each product is not necessarily performed.

TI assumes no liability for applications assistance or customer product design. Customers are responsible for their products and applications using TI components. To minimize the risks associated with customer products and applications, customers should provide adequate design and operating safeguards.

TI does not warrant or represent that any license, either express or implied, is granted under any TI patent right, copyright, mask work right, or other TI intellectual property right relating to any combination, machine, or process in which TI products or services are used. Information published by TI regarding third-party products or services does not constitute a license from TI to use such products or services or a warranty or endorsement thereof. Use of such information may require a license from a third party under the patents or other intellectual property of the third party, or a license from TI under the patents or other intellectual property of TI.

Reproduction of information in TI data books or data sheets is permissible only if reproduction is without alteration and is accompanied by all associated warranties, conditions, limitations, and notices. Reproduction of this information with alteration is an unfair and deceptive business practice. TI is not responsible or liable for such altered documentation.

Resale of TI products or services with statements different from or beyond the parameters stated by TI for that product or service voids all express and any implied warranties for the associated TI product or service and is an unfair and deceptive business practice. TI is not responsible or liable for any such statements.

Following are URLs where you can obtain information on other Texas Instruments products and application solutions:

Products		Applications	
Amplifiers	amplifier.ti.com	Audio	www.ti.com/audio
Data Converters	dataconverter.ti.com	Automotive	www.ti.com/automotive
DSP	dsp.ti.com	Broadband	www.ti.com/broadband
Interface	interface.ti.com	Digital Control	www.ti.com/digitalcontrol
Logic	logic.ti.com	Military	www.ti.com/military
Power Mgmt	power.ti.com	Optical Networking	www.ti.com/opticalnetwork
Microcontrollers	microcontroller.ti.com	Security	www.ti.com/security
		Telephony	www.ti.com/telephony
		Video & Imaging	www.ti.com/video
		Wireless	www.ti.com/wireless

Mailing Address: Texas Instruments
Post Office Box 655303 Dallas, Texas 75265