



TC04A
TC04B
TC05A
TC05B

LOW POWER, BANDGAP VOLTAGE REFERENCES

FEATURES

- Temperature Coefficient 50ppm/°C
- Wide Operating Current Range
 - TC04 15µA to 20mA
 - TC05 20µA to 20mA
- Dynamic Impedance 1Ω
- Output Tolerance Typ. 2%
- Output Voltage Option
 - TC04 1.25V
 - TC05 2.5V
- TO-92 Plastic Package
- 8-Pin Plastic Narrow Body SOIC Package

APPLICATIONS

- ADC and DAC Reference
- Current Source Generation
- Threshold Detectors
- Power Supplies
- Multimeters

GENERAL DESCRIPTION

The TC04 (1.25V output) and TC05 (2.5V output) bipolar, two-terminal, bandgap voltage references offer precision performance without premium price. These devices do not require thin-film resistors, greatly lowering manufacturing complexity and cost.

A 50ppm/°C output temperature coefficient and 15µA to 20mA operating current range make these devices attractive for multimeter, data acquisition converter, and telecommunication voltage references.

PIN CONFIGURATIONS

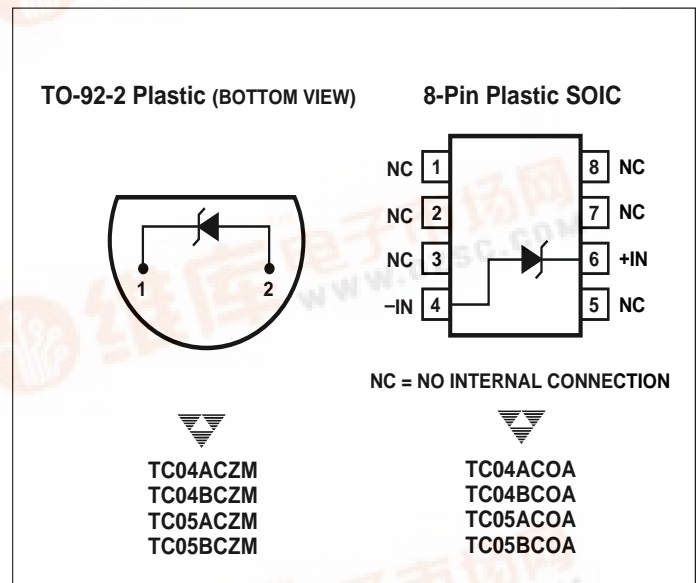

ORDERING INFORMATION

Part No.	Package	Temperature Range	Voltage	Max. Temperature Coefficient
TC04ACOA	8-Pin SOIC	0°C to +70°C	1.25V	50ppm/°C
TC04ACZM	TO-92-2	0°C to +70°C	1.25V	50ppm/°C
TC04BCOA	8-Pin SOIC	0°C to +70°C	1.25V	100ppm/°C
TC04BCZM	TO-92-2	0°C to +70°C	1.25V	100ppm/°C
TC05ACOA	8-Pin SOIC	0°C to +70°C	2.5V	50ppm/°C
TC05ACZM	TO-92-2	0°C to +70°C	2.5V	50ppm/°C
TC05BCOA	8-Pin SOIC	0°C to +70°C	2.5V	100ppm/°C
TC05BCZM	TO-92-2	0°C to +70°C	2.5V	100ppm/°C



**TC04A
TC04B
TC05A
TC05B**

**LOW POWER, BANDGAP
VOLTAGE REFERENCES**

ABSOLUTE MAXIMUM RATINGS*

Forward Current	+10mA
Reverse Current	+30mA
Storage Temperature Range	- 65°C to +150°C
Operating Temperature Range	
TO-92 Package	0°C to +70°C
Surface Mount Package	0°C to +70°C

Lead Temperature (Soldering, 10 sec)	
TO-92 Package	+300°C
Surface Mount Package	+300°C
Power Dissipation	Limited by Forward/ Reverse Current

*Functional operation above the absolute maximum stress ratings is not implied.

ELECTRICAL CHARACTERISTICS: $T_A = +25^\circ\text{C}$, unless otherwise specified.

Symbol	Parameter	Test Conditions	Min	Typ	Max	Unit
V_{BR}	Reverse Breakdown Voltage: TC04 TC05	$I_R = 100\mu\text{A}$	1.24 2.45	1.26 2.50	1.28 2.60	V
DV_{BR}	Reverse Breakdown Voltage Change: TC04 TC05	$15\mu\text{A} < I_R < 20\text{mA}$ $20\mu\text{A} < I_R < 1\text{mA}$ $20\mu\text{A} < I_R < 20\text{mA}$ $25\mu\text{A} < I_R < 1\text{mA}$	— — — —	10 0.25 10 0.25	20 1 20 1	mV
TC	Temperature Coefficient: TC04A/TC05A TC04B/TC05B	$I_R = 100\mu\text{A}$	— —	0.003 0.003	0.005 0.01	%/°C
I_R	Reverse Current: TC04 TC05		0.015 0.020	— —	20 20	mA

LOW POWER, BANDGAP VOLTAGE REFERENCES

TC04A
TC04B
TC05A
TC05B

RESPONSE TIME TEST CIRCUIT

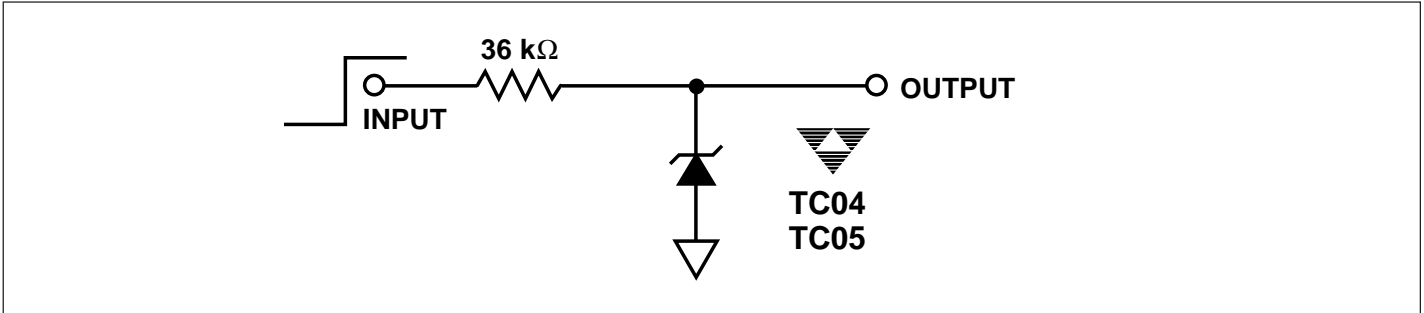

3

TYPICAL APPLICATIONS

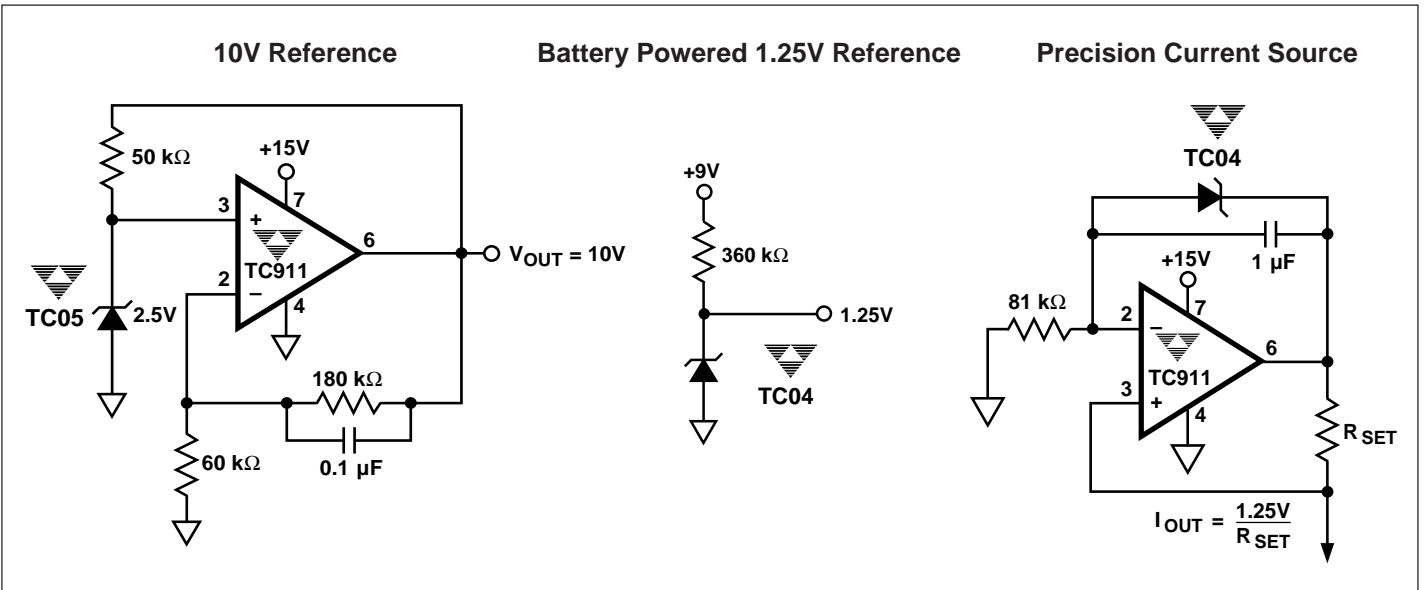

TC04A
 TC04B
 TC05A
 TC05B

LOW POWER, BANDGAP VOLTAGE REFERENCES

TYPICAL CHARACTERISTICS

TC04: Output Voltage vs Reverse Current

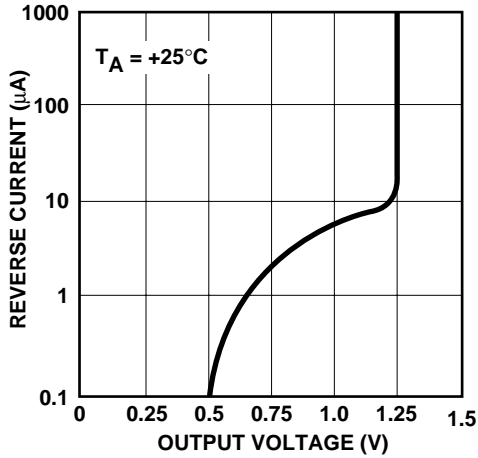

TC04: Output Voltage Change vs Reverse Current

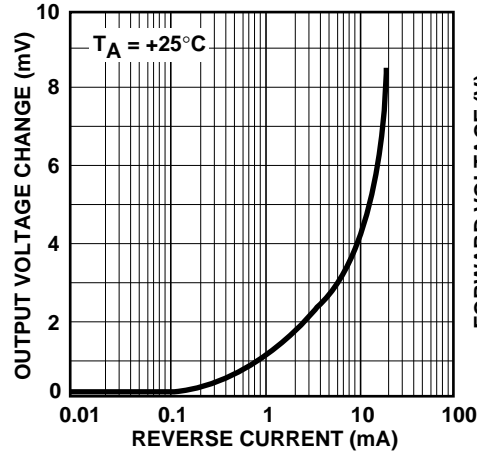

TC04: Forward Voltage vs Forward Current

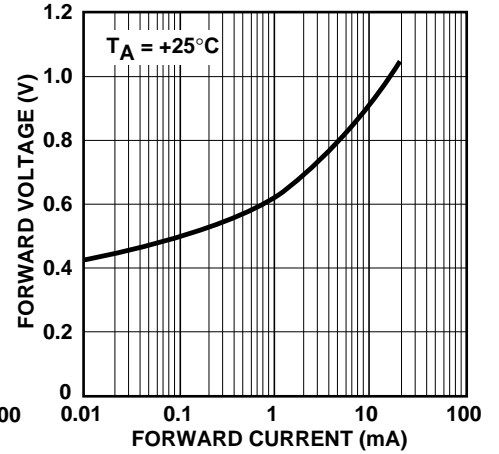

TC04 Response Time

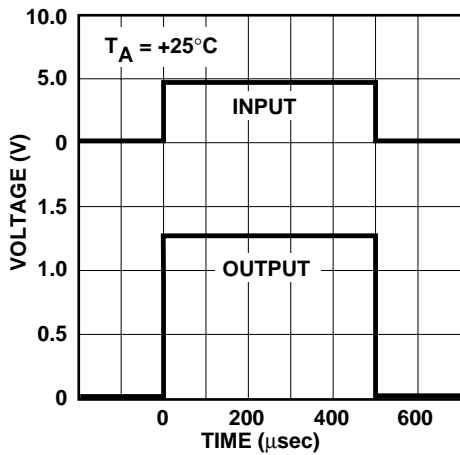

TC05: Output Voltage vs Reverse Current

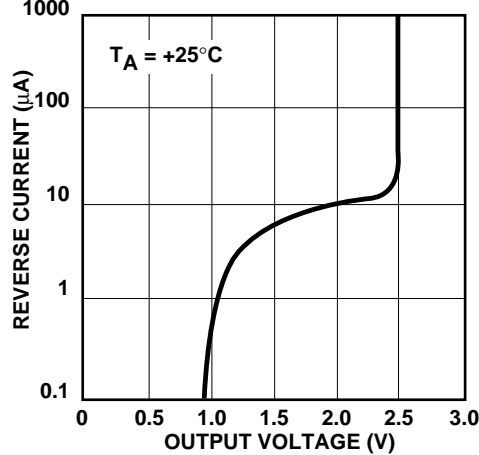

TC05: Output Voltage Change vs Reverse Current

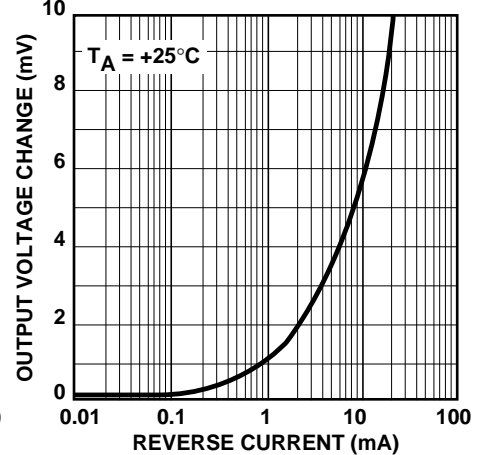

TC05: Forward Voltage vs Forward Current

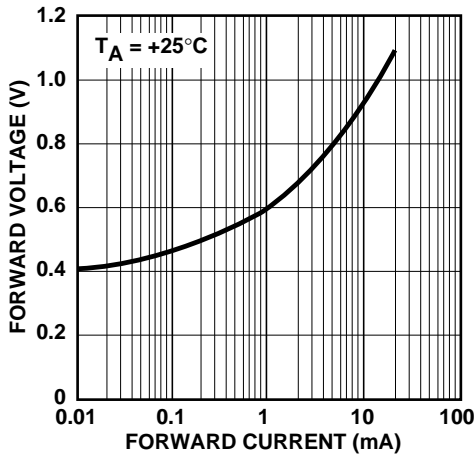

TC05 Response Time

