



TC1016

80mA, Tiny CMOS LDO With Shutdown

Features

- Space-Saving 5-Pin SC-70 Package
- Extremely Low Operating Current for Longer Battery Life: 53 μA (typ.)
- Very Low Dropout Voltage
- Rated 80 mA Output Current
- Requires only 1 μF Ceramic Output Capacitance
- High Output Voltage Accuracy: $\pm 0.5\%$ (typ.)
- 10 μsec (typ.) Wake-Up Time from $\overline{\text{SHDN}}$
- Power-Saving Shutdown Mode: 0.05 μA (typ.)
- Over-Current and Over-Temperature Protection
- Pin Compatible Upgrade for Bipolar Regulators

Applications

- Cellular / GSM / PHS Phones
- Battery Operated Systems
- Portable Computers
- Medical Instruments
- Electronic Games
- Pagers

General Description

The TC1016 is a high accuracy (typically $\pm 0.5\%$) CMOS upgrade for bipolar low dropout regulators. It is offered in an SC-70 package, which represents 50% reduced footprint vs. the popular SOT-23 package.

Developed specifically for battery-powered systems, the device's CMOS construction consumes only 53 μA typical supply current over the entire 80 mA operating load range. This can be as much as 60 times less than the quiescent operating current consumed by bipolar LDOs.

With small space requirements and cost in mind, the TC1016 was developed to be stable over the entire input voltage and output current operating range using low value (1 μF ceramic), low equivalent series resistance output capacitors. Additional integrated features such as shutdown, over-current and over-temperature protection further reduce the board space and cost of the entire voltage regulating application.

Key performance parameters for the TC1016 are low drop out voltage (150 mV typical at 80 mA output current), low supply current while shutdown (0.05 μA typical) and fast stable response to sudden input voltage and load changes.

Pin Configurations

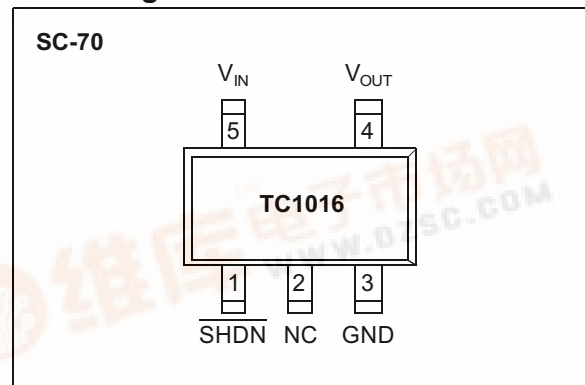

TC1016

1.0 ELECTRICAL CHARACTERISTICS ABSOLUTE MAXIMUM RATINGS*

Input Voltage6.5V
 Output Voltage(–0.3) to (V_{IN} + 0.3)
 Power Dissipation Internally Limited (Note 7)
 Operating Temperature –40°C < T_J < 125°C
 Storage Temperature –65°C to +150°C
 Maximum Voltage On Any Pin V_{IN} + 0.3V to –0.3V

***Notice:** Static-sensitive device. Unused devices must be stored in conductive material. Protect devices from static discharge and static fields. Stresses above those listed under Absolute Maximum Ratings may cause permanent damage to the device. These are stress ratings only and functional operation of the device at these or any other conditions above those indicated in the operational sections of the specifications is not implied. Exposure to Absolute Maximum Rating Conditions for extended periods may affect device reliability

PIN FUNCTION TABLE

Name	Function
SHDN	Shutdown control input. The regulator is fully enabled when a logic high is applied to this input. The regulator enters shutdown when a logic low is applied to this input. During shutdown, output voltage falls to zero, and supply current is reduced to 0.5 μA (typ.).
NC	No Connect
GND	Ground Terminal
V _{OUT}	Regulated voltage output.
V _{IN}	Unregulated supply input.

ELECTRICAL CHARACTERISTICS

V_{IN} = V_R + 1V, I_L = 100 μA, C_L = 1.0μF, SHDN > V_{IH}, T_A = 25°C, unless otherwise noted. **Boldface** type specifications apply for junction temperatures of –40°C to +125°C.

Parameter	Sym	Min	Typ	Max	Units	Test Conditions
Input Operating Voltage	V _{IN}	2.7	—	6.0	V	Note 1
Maximum Output Current	I _{OUTMAX}	80	—	—	mA	
Output Voltage	V _{OUT}	V_R – 2.5%	V _R ±0.5%	V_R + 2.5%	V	Note 2
V _{OUT} Temperature Coefficient	TCV _{OUT}	—	40	—	ppm/°C	Note 3
Line Regulation	(ΔV _{OUT} /ΔV _{IN}) / V _R	—	0.01	0.2	%/V	(V _R + 1V) < V _{IN} < 6V
Load Regulation (Note 4)	ΔV _{OUT} / V _R	—	0.23	1	%	I _L = 0.1 mA to I _{OUTMAX}
Dropout Voltage (Note 5)	V _{IN} – V _{OUT}	—	2 100 150	— 200 300	mV	I _L = 100 μA I _L = 50 mA I _L = 80 mA
Supply Current	I _{IN}	—	53	90	μA	SHDN = V _{IH} , I _L = 0
Shutdown Supply Current	I _{INSD}	—	0.05	0.5	μA	SHDN = 0V
Power Supply Rejection Ratio	PSRR	—	58	—	dB	f = 1 kHz, I _L = 50 mA
Wake-Up Time (from Shutdown Mode)	t _{WK}	—	10	—	μs	V _{IN} = 5V, I _L = 60 mA, C _{IN} = 1 μF, C _{OUT} = 1 μF, f = 100 Hz
Settling Time (from Shutdown Mode)	t _S	—	32	—	μs	V _{IN} = 5V, I _L = 60 mA, C _{IN} = 1 μF, C _{OUT} = 1 μF, f = 100 Hz
Output Short Circuit Current	I _{OUTSC}	—	120	—	mA	V _{OUT} = 0V
Thermal Regulation	V _{OUT} /P _D	—	0.04	—	V/W	Notes 6, 7
Thermal Shutdown Die Temperature	T _{SD}	—	160	—	°C	
Thermal Shutdown Hysteresis	ΔT _{SD}	—	10	—	°C	
Output Noise	eN	—	800	—	nV/√Hz	f = 10 kHz
SHDN Input High Threshold	V _{IH}	60	—	—	%V _{IN}	V _{IN} = 2.7V to 6.0V
SHDN Input Low Threshold	V _{IL}	—	—	15	%V _{IN}	V _{IN} = 2.7V to 6.0V

- Note** 1: The minimum V_{IN} has to meet two conditions: V_{IN} ≥ 2.7V and V_{IN} ≥ (V_R + 2.5%) + V_{DROPOUT}.
 2: V_R is the regulator voltage setting. For example: V_R = 1.8V, 2.7V, 2.8V, 3.0V.

$$3: TCV_{OUT} = \frac{(V_{OUTMAX} - V_{OUTMIN}) \times 10^6}{V_{OUT} \times \Delta T}$$

- 4: Regulation is measured at a constant junction temperature using low duty cycle pulse testing. Load regulation is tested over a load range from 0.1 mA to the maximum specified output current. Changes in output voltage due to heating effects are covered by the thermal regulation specification.
 5: Dropout voltage is defined as the input to output differential at which the output voltage drops 2% below its nominal value at a 1V differential.
 6: Thermal regulation is defined as the change in output voltage at a time T after a change in power dissipation is applied, excluding load or line regulation effects. Specifications are for a current pulse equal to I_{lmax} at V_{IN} = 6V for t = 10 msec.
 7: The maximum allowable power dissipation is a function of ambient temperature, the maximum allowable junction temperature and the thermal resistance from junction-to-air (i.e. T_A, T_J, θ_{JA}). Exceeding the maximum allowable power dissipation causes the device to initiate thermal shutdown. Please see "Thermal Considerations" section of this datasheet for more details.

2.0 DETAILED DESCRIPTION

The TC1016 is a precision fixed output linear voltage regulator. The internal linear pass element is a P-Channel MOSFET. As with all P-Channel CMOS LDOs there is a body drain diode with the cathode connected to V_{IN} and the anode connected to V_{OUT} (Figure 2-1).

As shown in Figure 2-1, the output voltage of the LDO is sensed and divided down internally to reduce external component count. The internal error amplifier has a fixed bandgap reference on the inverting input and the sensed output voltage on the non-inverting input. The error amplifier output will pull the gate voltage down until the inputs of the error amplifier are equal to regulate the output voltage.

By sensing the current in the P-Channel MOSFET, the maximum current delivered to the load is limited to a typical value of 120 mA preventing excessive current from damaging the printed circuit board in the event of a shorted or faulted load.

An internal thermal sensing device is used to monitor the junction temperature of the LDO. When the sensed temperature is over the set threshold of 160°C typical, the P-Channel MOSFET is turned off. When the P-Channel is off, the power dissipation internal to the device is almost zero. The device cools until the junction temperature is approximately 150°C and the P-Channel is turned on. If the internal power dissipation

is still high enough for the junction to rise to 160°C it will again shut off and cool. The maximum operating junction temperature of the device is 125°C. Steady state operation at or near the 160°C over temperature point can lead to permanent damage of the device.

The output voltage V_{OUT} , remains stable over the entire input operating voltage range (2.7V to 6.0V) and the entire load range (0 mA to 80 mA). The output voltage is sensed through an internal resistor divider and compared with a precision internal voltage reference. Several fixed output voltages are available by changing the value of the internal resistor divider.

Figure 2-2 shows a typical application circuit. The regulator is enabled any time the shutdown input pin is at or above V_{IH} , and shutdown (disabled) any time the shutdown input pin is below V_{IL} . For applications where the SHDN feature is not used, tie the SHDN pin directly to the input supply voltage source. While in shutdown, the supply current decreases to 0.05 μA (typical) and the P-Channel MOSFET is turned off.

As shown in Figure 2-2, batteries have internal source impedance. An input capacitor is used to lower the input impedance of the LDO. In some applications, high input impedance can cause the LDO to become unstable. Adding more input capacitance can compensate for this.

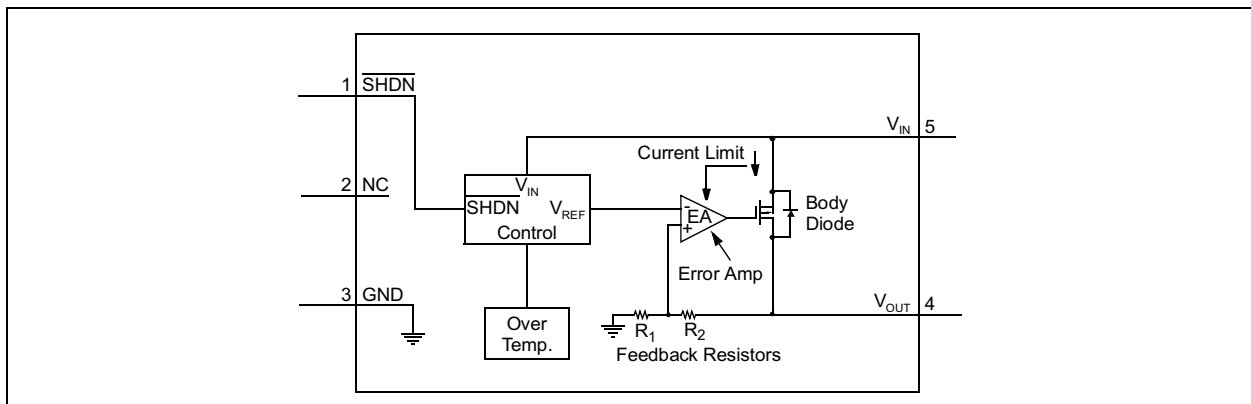

FIGURE 2-1: TC1016 Block Diagram.

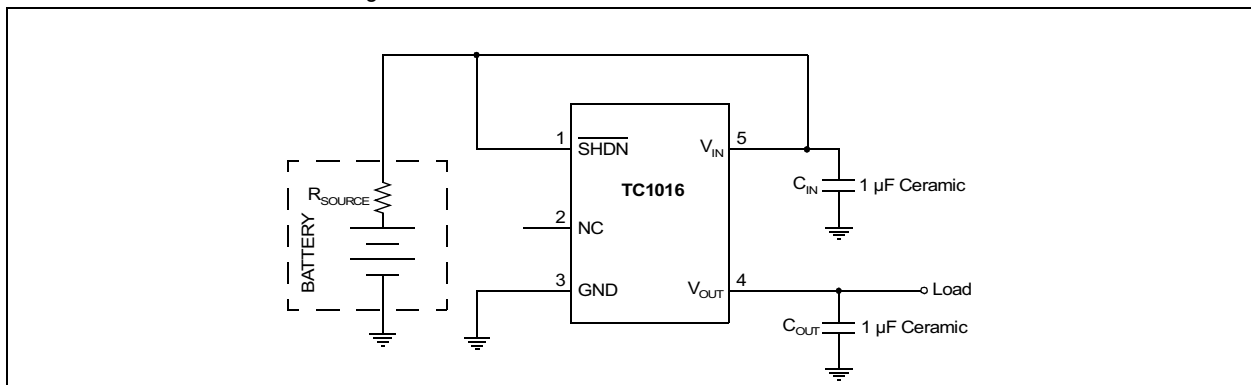

FIGURE 2-2: Typical Application Circuit.

TC1016

2.1 Input Capacitor

Low input source impedance is necessary for the LDO to operate properly. When operating off of batteries or in applications with long lead length (> 10") between the input source and the LDO, some input capacitance is required. A minimum of 0.1 μF is recommended for most applications and the capacitor should be placed as close to the input of the LDO as practical. Larger input capacitors will help reduce the input impedance and further reduce any high frequency noise on the input and output of the LDO.

2.2 Output Capacitor

A minimum output capacitance of 1 μF for the TC1016 is required for stability. The equivalent series resistance (ESR) requirements on the output capacitor are between 0 and 2 ohms. The output capacitor should be located as close to the LDO output as practical. Ceramic materials X7R and X5R have low temperature coefficients and are well within the acceptable ESR range required. A typical 1 μF X5R 0805 capacitor has an ESR of 50 milli-ohms. Larger output capacitors can be used with the TC1016 to improve dynamic behavior and input ripple rejection performance.

Ceramic, aluminum electrolytic or tantalum capacitor types can be used. Since many aluminum electrolytic capacitors freeze at approximately -30°C , ceramic or solid tantalums are recommended for applications operating below -25°C . When operating from sources other than batteries, supply-noise rejection and transient response can be improved by increasing the value of the input and output capacitors and employing passive filtering techniques.

2.3 Turn On Response

The turn on response is defined as two separate response categories, Wake-Up Time (t_{WK}) and Settling Time (t_{S}).

The TC1016 has a fast Wake-Up Time (10 μsec typical) when released from shutdown. See Figure 2-3 for the Wake-Up Time designated as t_{WK} . The Wake-Up Time is defined as the time it takes for the output to rise to 2% of the V_{OUT} value after being released from shutdown.

The total turn on response is defined as the Settling Time (t_{S}), see Figure 2-3. Settling Time (inclusive with t_{WK}) is defined as the condition when the output is within 98% of its fully enabled value (42 μsec typical) when released from shutdown. The settling time of the output voltage is dependent on load conditions and output capacitance on V_{OUT} (RC response).

The table below demonstrates the typical turn on response timing for different input voltage power-up frequencies: $V_{\text{OUT}} = 2.8\text{V}$, $V_{\text{IN}} = 5.0\text{V}$, $I_{\text{OUT}} = 60\text{mA}$ and $C_{\text{OUT}} = 1\mu\text{F}$.

Frequency	Typical (t_{WK})	Typical (t_{S})
1000 Hz	5.3 μsec	14 μsec
500 Hz	5.9 μsec	16 μsec
100 Hz	9.8 μsec	32 μsec
50 Hz	14.5 μsec	52 μsec
10 Hz	17.2 μsec	77 μsec

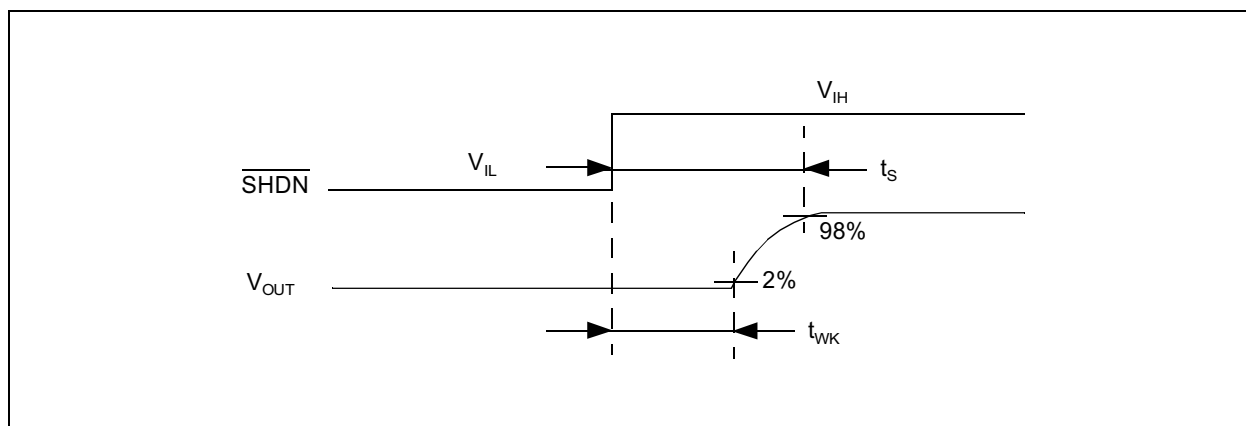

FIGURE 2-3: Wake-Up Time from Shutdown.

3.0 THERMAL CONSIDERATIONS

3.1 Thermal Shutdown

Integrated thermal protection circuitry shuts the regulator off when die temperature exceeds approximately 160°C. The regulator remains off until the die temperature drops to approximately 150°C.

3.2 Power Dissipation

The TC1016 is available in the SC70 package. The thermal resistance for the SC70 package is approximately 450°C/W when the copper area used in the printed circuit board layout is similar to the JEDEC J51-7 high thermal conductivity standard or Semi G42-88 standard. For applications with larger or thicker copper area, the thermal resistance can be lowered. See AN792 for a method to determine the thermal resistance for a particular application.

The TC1016 power dissipation capability is dependant upon several variables, input voltage, output voltage, load current, ambient temperature and maximum junction temperature. The absolute maximum steady state junction temperature is rated at 125°C. The power dissipation within the device is equal to:

$$P_D = (V_{IN} - V_{OUT}) \times I_{LOAD} + V_{IN} \times I_{GND} \quad [3-1]$$

The $V_{IN} \times I_{GND}$ term is typically very small when compared to the $(V_{IN} - V_{OUT}) \times I_{LOAD}$ term simplifying the power dissipation within the LDO to be:

$$P_D = (V_{IN} - V_{OUT}) \times I_{LOAD} \quad [3-2]$$

To determine the maximum power dissipation capability, the following equation is used:

$$P_{D_{MAX}} = \frac{(T_{J_{MAX}} - T_{A_{MAX}})}{R\theta_{JA}} \quad [3-3]$$

Where:

$T_{J_{MAX}}$ = the maximum junction temperature allowed

$T_{A_{MAX}}$ = the maximum ambient temperature

$R\theta_{JA}$ = the thermal resistance from junction to air

Given the following example:

$$\begin{aligned} V_{IN} &= 3.0V \text{ to } 4.1V \\ V_{OUT} &= 2.8V \pm 2.5\% \\ I_{LOAD} &= 60 \text{ mA (output current)} \\ T_{AMAX} &= 55^\circ\text{C (max. ambient temp.)} \end{aligned}$$

Find:

1. Internal power dissipation:

$$\begin{aligned} P_{D_{MAX}} &= (V_{IN_{MAX}} - V_{OUT_{MIN}}) \times I_{LOAD} \\ &= (4.1V - 2.8 \times (0.975)) \times 60mA \\ &= 82.2mW \end{aligned}$$

2. Junction temperature:

$$\begin{aligned} T_{J_{MAX}} &= P_{D_{MAX}} \times R\theta_{JA} \\ &= 82.2mWatts \times 450^\circ\text{C/W} + T_{AMAX} \\ &= 37^\circ\text{C} + 55^\circ\text{C} \\ &= 92^\circ\text{C} \end{aligned}$$

3. Maximum allowable dissipation:

$$\begin{aligned} P_D &= \frac{T_{J_{MAX}} - T_{A_{MAX}}}{R\theta_{JA}} \\ &= \frac{125^\circ\text{C} - 55^\circ\text{C}}{450^\circ\text{C/W}} \\ &= 155mW \end{aligned}$$

In this example, the TC1016 dissipates approximately 82.2 mWatts and the junction temperature is raised 37°C over the 55°C ambient to 92°C. The absolute maximum power dissipation is 155 mW when given a maximum ambient temperature of 55°C.

Input voltage, output voltage or load current limits can also be determined by substituting known values in equations 3-2 and 3-3.

3.3 Layout Considerations

The primary path for heat conduction out of the SC70 package is through the package leads. Using heavy wide traces at the pads of the device will facilitate the removal of the heat within the package thus lowering the thermal resistance $R\theta_{JA}$. By lowering the thermal resistance, the maximum internal power dissipation capability of the package is increased.

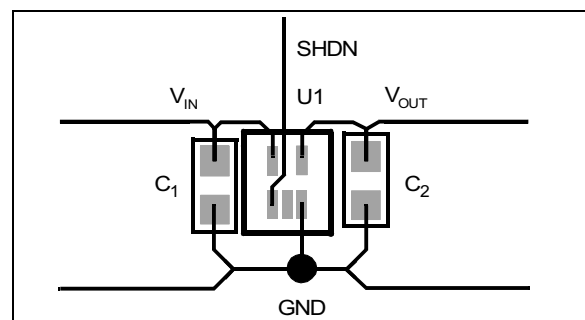

FIGURE 3-1: Suggested layout

TC1016

4.0 TYPICAL PERFORMANCE CHARACTERISTICS

Note: The graphs and tables provided following this note are a statistical summary based on a limited number of samples and are provided for informational purposes only. The performance characteristics listed herein are not tested or guaranteed. In some graphs or tables, the data presented may be outside the specified operating range (e.g., outside specified power supply range) and therefore outside the warranted range.

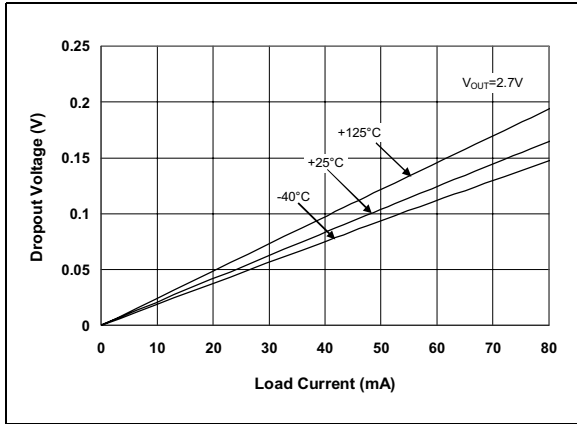

FIGURE 4-1: Dropout Voltage vs. Output Current.

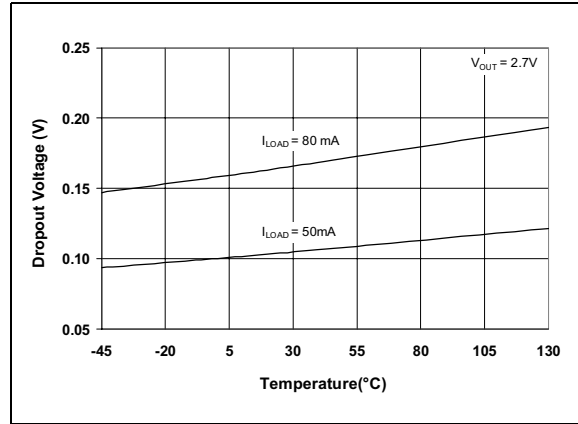

FIGURE 4-4: Dropout Voltage vs. Temperature.

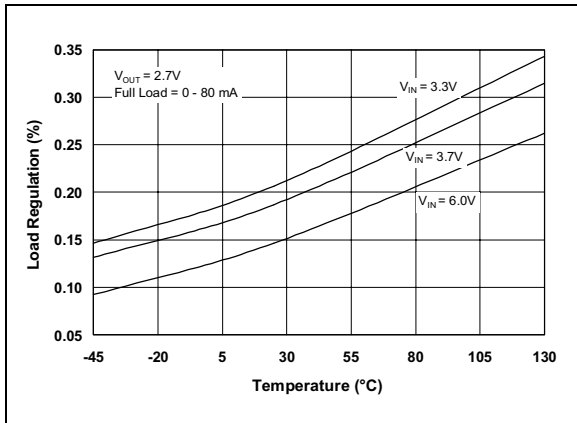

FIGURE 4-2: Load Regulation vs. Temperature.

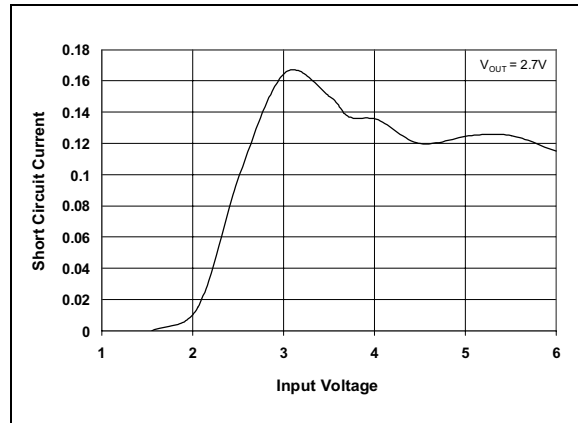

FIGURE 4-5: Short Circuit Current vs. Input Voltage.

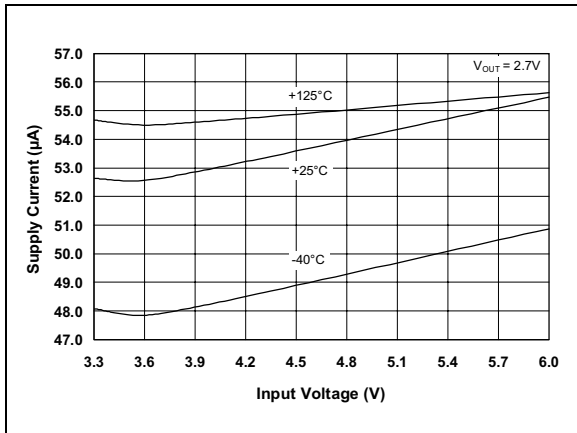

FIGURE 4-3: Supply Current vs. Input Voltage.

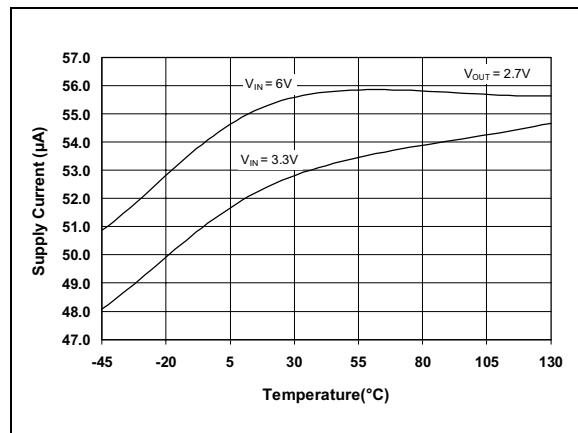

FIGURE 4-6: Supply Current vs. Temperature.

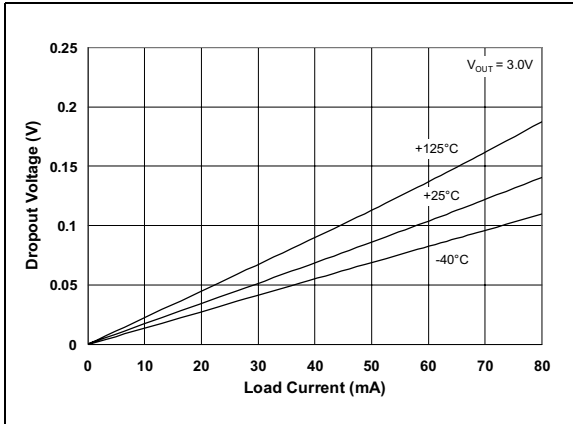

FIGURE 4-7: Dropout Voltage vs. Output Current.

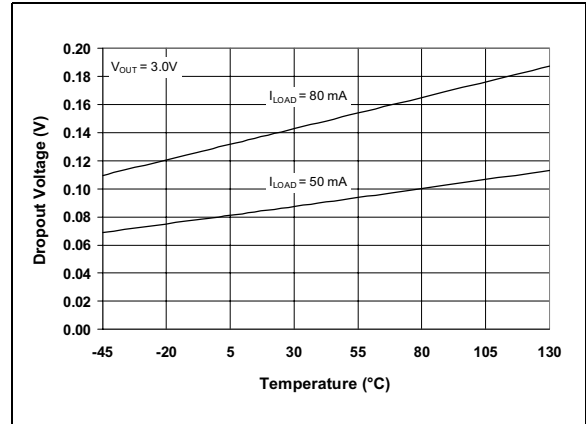

FIGURE 4-10: Dropout Voltage vs. Temperature.

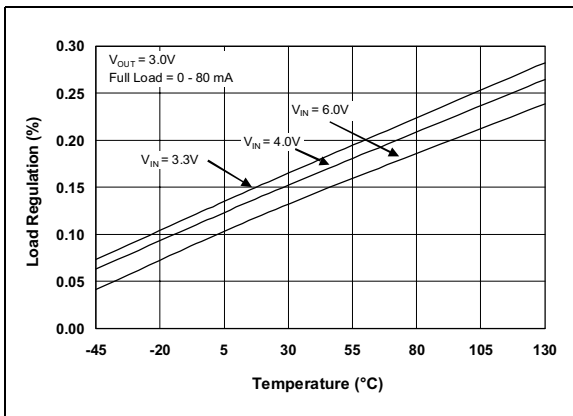

FIGURE 4-8: Load Regulation vs. Temperature.

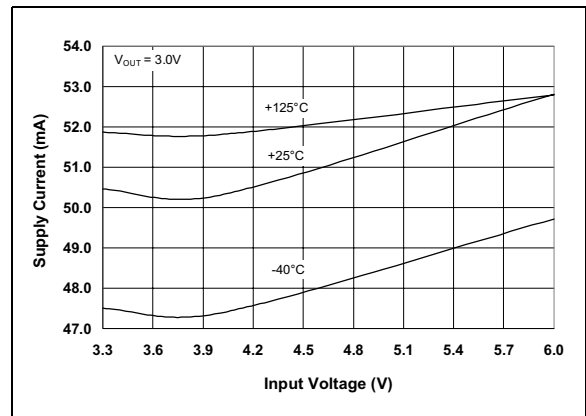

FIGURE 4-11: Supply Current vs. Input Voltage

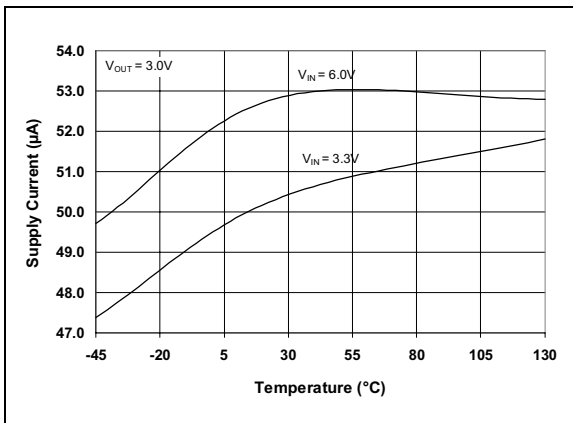

FIGURE 4-9: Supply Current vs. Temperature.

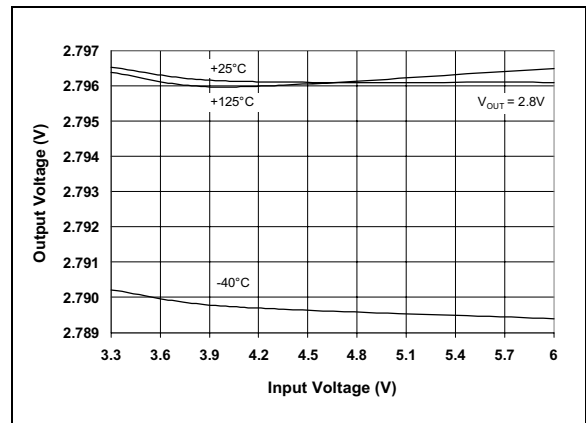

FIGURE 4-12: Output Voltage vs. Supply Voltage.

TC1016

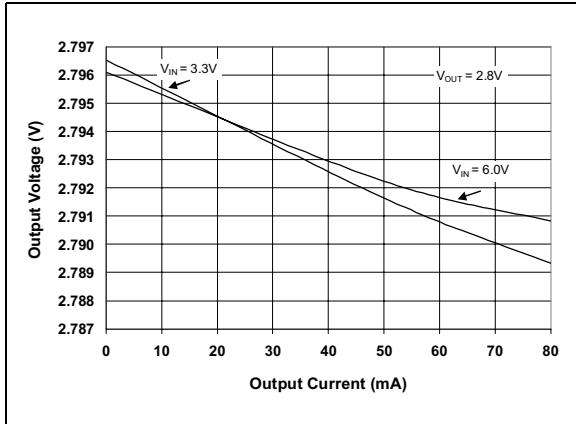

FIGURE 4-13: Output Voltage vs. Output Current.

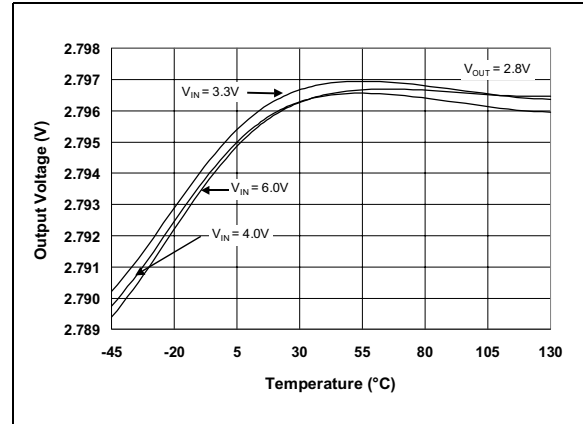

FIGURE 4-16: Output Voltage vs. Temperature.

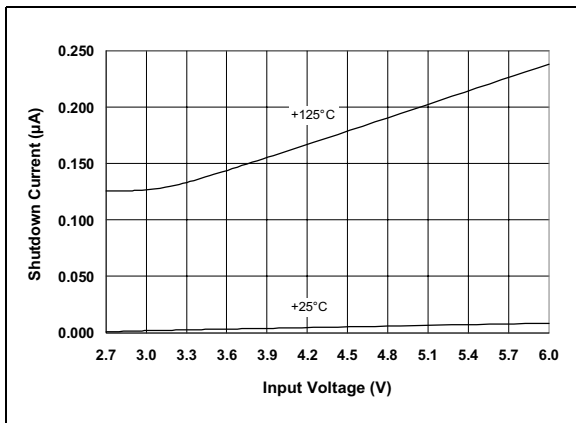

FIGURE 4-14: Shutdown Current vs. Input Voltage.

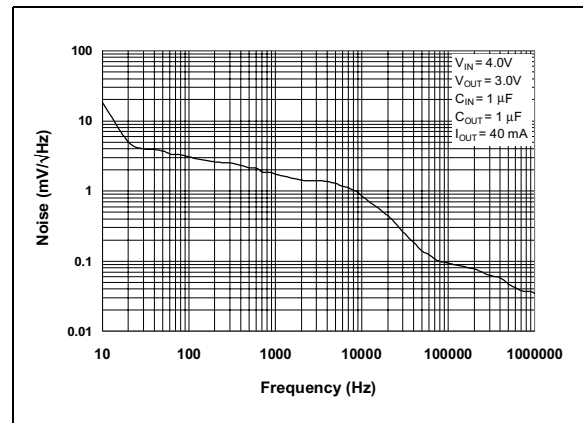

FIGURE 4-17: Output Noise vs. Frequency.

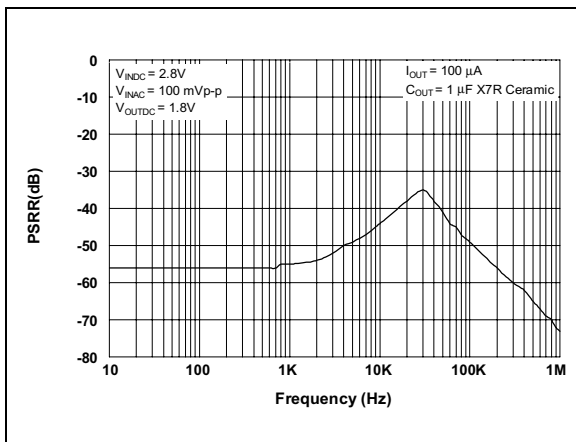

FIGURE 4-15: Power Supply Rejection Ratio vs. Frequency.

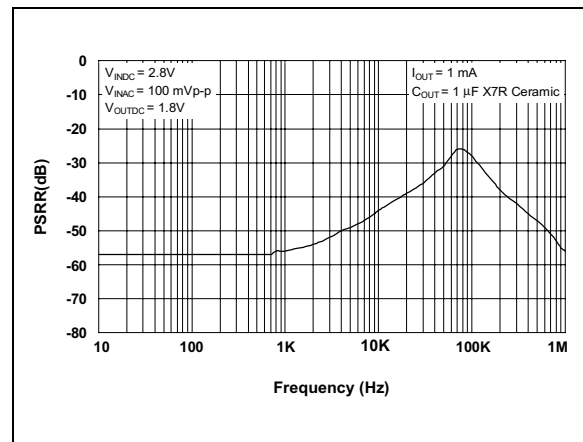

FIGURE 4-18: Power Supply Rejection Ratio vs. Frequency.

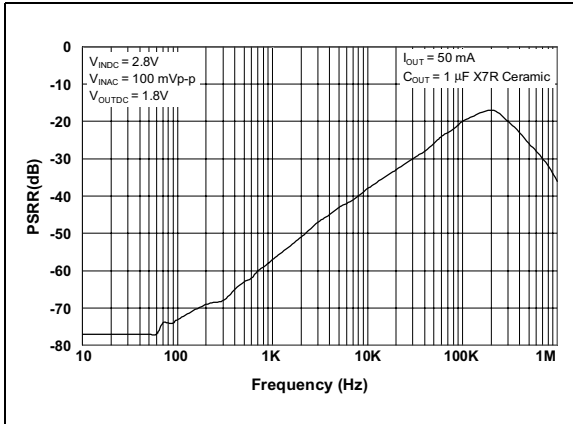

FIGURE 4-19: Power Supply Rejection Ratio vs. Frequency.

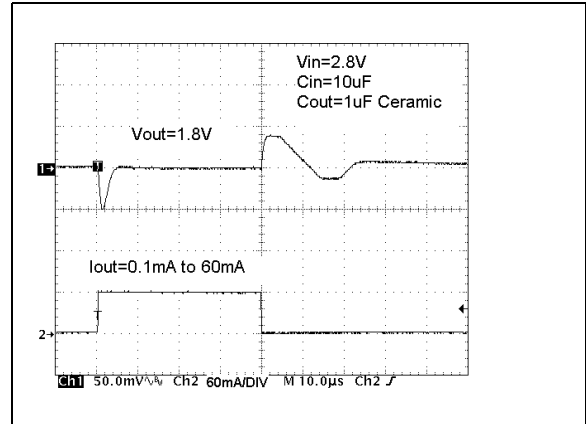

FIGURE 4-22: Load Transient Response.

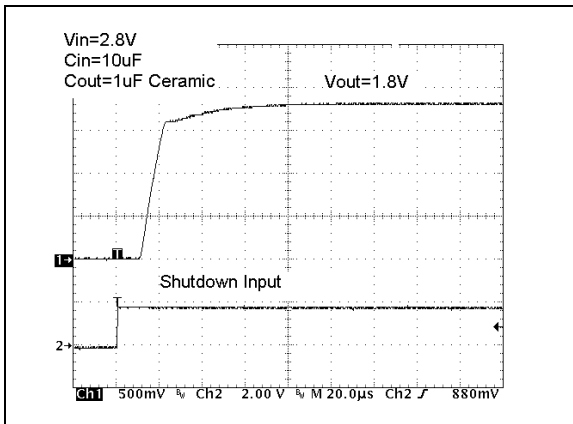

FIGURE 4-20: Wake-Up Response.

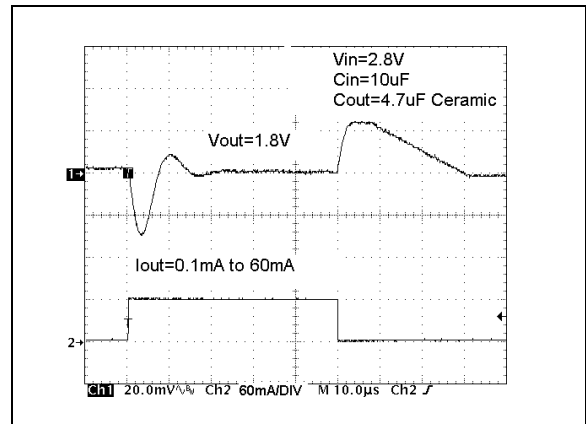

FIGURE 4-23: Load Transient Response.

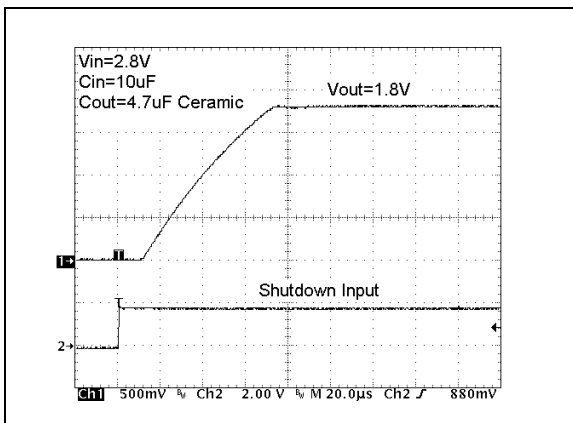

FIGURE 4-21: Wake-Up Response.

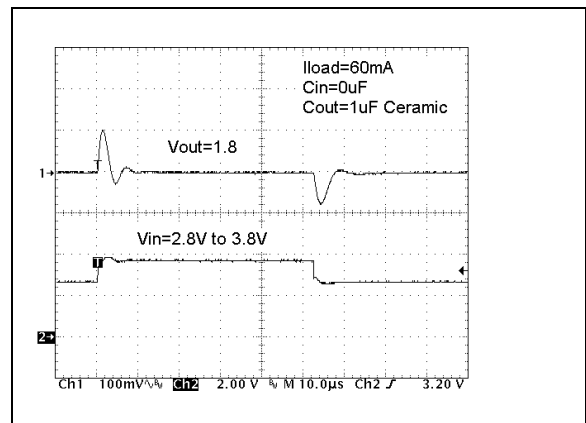

FIGURE 4-24: Line Transient Response.

TC1016

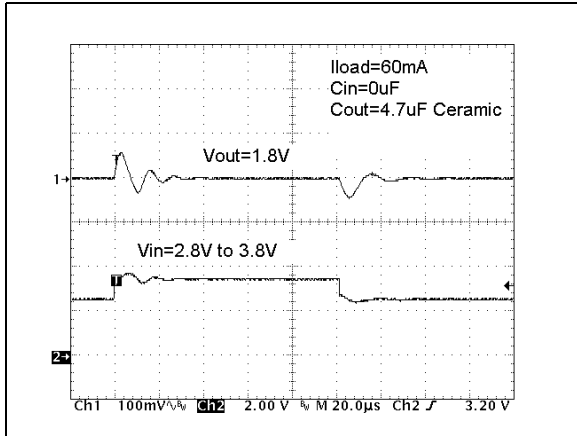

FIGURE 4-25: Line Transient Response.

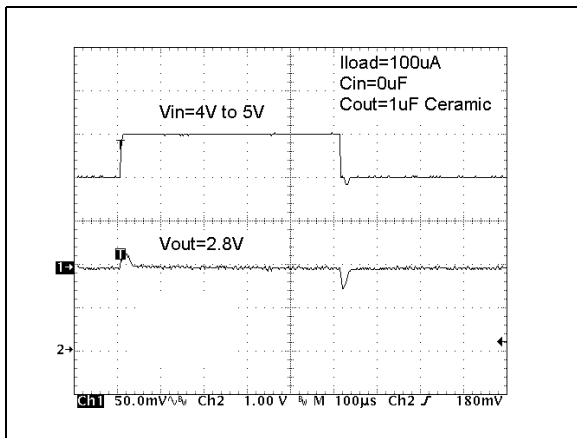

FIGURE 4-26: Line Transient Response.

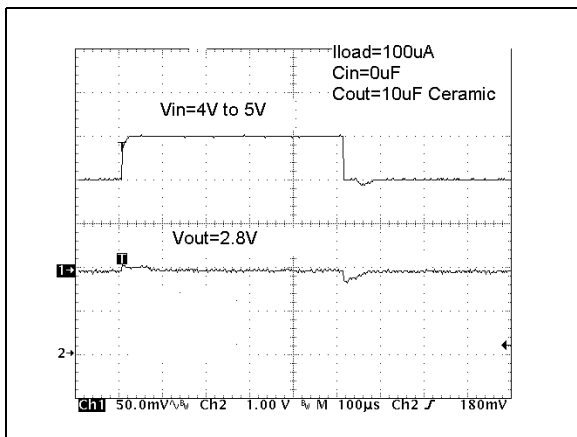
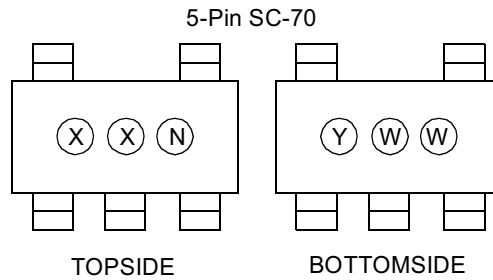

FIGURE 4-27: Line Transient Response.

5.0 PACKAGE INFORMATION

5.1 Package Marking Information



Part Number	Code
TC1016 - 1.8VLT	AA
TC1016 - 2.7VLT	AD
TC1016 - 2.8VLT	AB
TC1016 - 3.0VLT	AC

Legend: X Part Number + temperature range and voltage
X Part Number + temperature range and voltage
N Traceability code
Y Year
WW Work week

Note: In the event the full Microchip part number cannot be marked on one line, it will be carried over to the next line thus limiting the number of available characters for customer specific information.

TC1016

5.2 Package Dimensions

Component Taping Orientation for 5-Pin SC-70

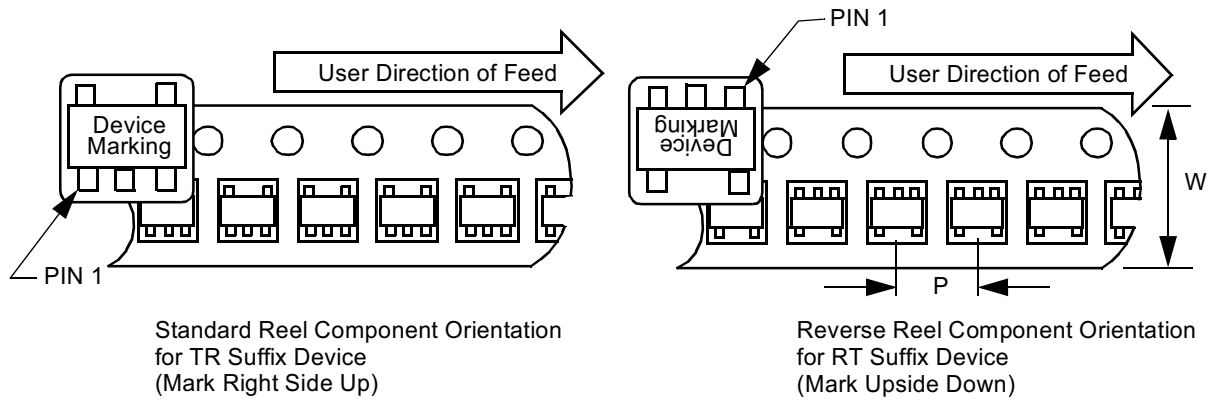

Carrier Tape, Number of Components Per Reel and Reel Size:

Package	Carrier Width (W)	Pitch (P)	Part Per Full Reel	Reel Size
5-Pin SO-70	8 mm	4 mm	3000	7 in.

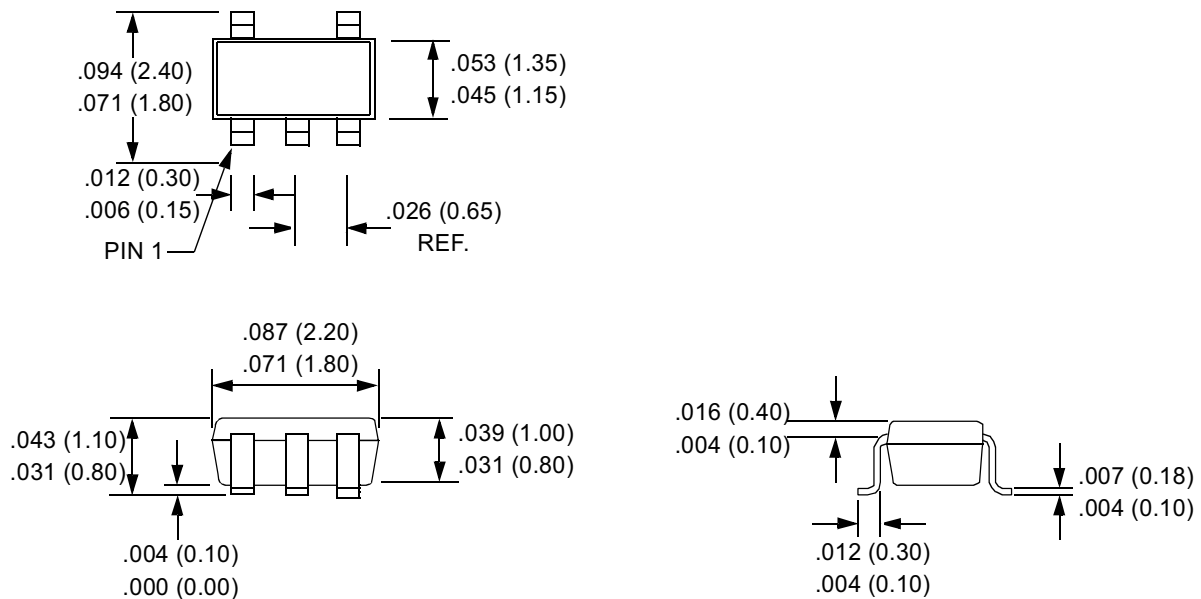

Dimensions: inches (mm)

ON-LINE SUPPORT

Microchip provides on-line support on the Microchip World Wide Web (WWW) site.

The web site is used by Microchip as a means to make files and information easily available to customers. To view the site, the user must have access to the Internet and a web browser, such as Netscape or Microsoft Explorer. Files are also available for FTP download from our FTP site.

Connecting to the Microchip Internet Web Site

The Microchip web site is available by using your favorite Internet browser to attach to:

www.microchip.com

The file transfer site is available by using an FTP service to connect to:

<ftp://ftp.microchip.com>

The web site and file transfer site provide a variety of services. Users may download files for the latest Development Tools, Data Sheets, Application Notes, User's Guides, Articles and Sample Programs. A variety of Microchip specific business information is also available, including listings of Microchip sales offices, distributors and factory representatives. Other data available for consideration is:

- Latest Microchip Press Releases
- Technical Support Section with Frequently Asked Questions
- Design Tips
- Device Errata
- Job Postings
- Microchip Consultant Program Member Listing
- Links to other useful web sites related to Microchip Products
- Conferences for products, Development Systems, technical information and more
- Listing of seminars and events

Systems Information and Upgrade Hot Line

The Systems Information and Upgrade Line provides system users a listing of the latest versions of all of Microchip's development systems software products. Plus, this line provides information on how customers can receive any currently available upgrade kits. The Hot Line Numbers are:

1-800-755-2345 for U.S. and most of Canada, and
1-480-792-7302 for the rest of the world.

013001

TC1016

READER RESPONSE

It is our intention to provide you with the best documentation possible to ensure successful use of your Microchip product. If you wish to provide your comments on organization, clarity, subject matter, and ways in which our documentation can better serve you, please FAX your comments to the Technical Publications Manager at (480) 792-4150.

Please list the following information, and use this outline to provide us with your comments about this Data Sheet.

To: Technical Publications Manager Total Pages Sent
RE: Reader Response
From: Name _____
Company _____
Address _____
City / State / ZIP / Country _____
Telephone: (____) _____ - _____ FAX: (____) _____ - _____

Application (optional):

Would you like a reply? ___Y ___N

Device: **TC1016** Literature Number: **DS21666A**

Questions:

1. What are the best features of this document?

2. How does this document meet your hardware and software development needs?

3. Do you find the organization of this data sheet easy to follow? If not, why?

4. What additions to the data sheet do you think would enhance the structure and subject?

5. What deletions from the data sheet could be made without affecting the overall usefulness?

6. Is there any incorrect or misleading information (what and where)?

7. How would you improve this document?

8. How would you improve our software, systems, and silicon products?

PRODUCT IDENTIFICATION SYSTEM

To order or obtain information, e.g., on pricing or delivery, refer to the factory or the listed sales office.

<u>PART NO.</u>	<u>XX</u>	<u>X</u>
Device	Voltage Range	Temperature Range
Device:	TC1016: 80 mA Tiny CMOS LDO with Shutdown	
Voltage Range:	AA = 1.8V AD = 2.7V AB = 2.8V AC = 3.0V	
Temperature Range:	V = -40°C to +125°C	
Package:	5-pin SC-70	

Examples:

- a) TC1016-1.8VLTTR: 80 mA Tiny CMOS LDO with Shutdown.
- b) TC1016-2.7VLTTR: 80 mA Tiny CMOS LDO with Shutdown.
- c) TC1016-2.8VLTTR: 80 mA Tiny CMOS LDO with Shutdown.
- d) TC1016-3.0VLTTR: 80 mA Tiny CMOS LDO with Shutdown.

Sales and Support

Data Sheets

Products supported by a preliminary Data Sheet may have an errata sheet describing minor operational differences and recommended workarounds. To determine if an errata sheet exists for a particular device, please contact one of the following:

1. Your local Microchip sales office
2. The Microchip Corporate Literature Center U.S. FAX: (480) 792-7277
3. The Microchip Worldwide Site (www.microchip.com)

Please specify which device, revision of silicon and Data Sheet (include Literature #) you are using.

New Customer Notification System

Register on our web site (www.microchip.com/cn) to receive the most current information on our products.

TC1016

NOTES:

NOTES:

TC1016

NOTES:

Information contained in this publication regarding device applications and the like is intended through suggestion only and may be superseded by updates. It is your responsibility to ensure that your application meets with your specifications. No representation or warranty is given and no liability is assumed by Microchip Technology Incorporated with respect to the accuracy or use of such information, or infringement of patents or other intellectual property rights arising from such use or otherwise. Use of Microchip's products as critical components in life support systems is not authorized except with express written approval by Microchip. No licenses are conveyed, implicitly or otherwise, under any intellectual property rights.

Trademarks

The Microchip name and logo, the Microchip logo, FilterLab, KEELoQ, MPLAB, PIC, PICmicro, PICMASTER, PICSTART, PRO MATE, SEEVAL and The Embedded Control Solutions Company are registered trademarks of Microchip Technology Incorporated in the U.S.A. and other countries.

dsPIC, ECONOMONITOR, FanSense, FlexROM, fuzzyLAB, In-Circuit Serial Programming, ICSP, ICEPIC, microID, microPort, Migratable Memory, MPASM, MPLIB, MPLINK, MPSIM, MXDEV, PICC, PICDEM, PICDEM.net, rPIC, Select Mode and Total Endurance are trademarks of Microchip Technology Incorporated in the U.S.A.

Serialized Quick Term Programming (SQTP) is a service mark of Microchip Technology Incorporated in the U.S.A.

All other trademarks mentioned herein are property of their respective companies.

© 2001, Microchip Technology Incorporated, Printed in the U.S.A., All Rights Reserved.

 Printed on recycled paper.

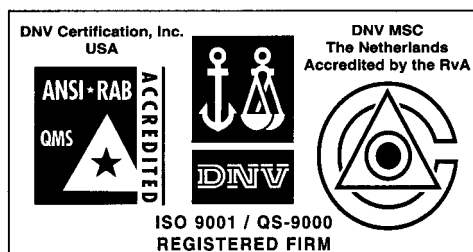

Microchip received QS-9000 quality system certification for its worldwide headquarters, design and wafer fabrication facilities in Chandler and Tempe, Arizona in July 1999. The Company's quality system processes and procedures are QS-9000 compliant for its PICmicro® 8-bit MCUs, KEELoQ® code hopping devices, Serial EEPROMs and microperipheral products. In addition, Microchip's quality system for the design and manufacture of development systems is ISO 9001 certified.



MICROCHIP

WORLDWIDE SALES AND SERVICE

AMERICAS

Corporate Office

2355 West Chandler Blvd.
Chandler, AZ 85224-6199
Tel: 480-792-7200 Fax: 480-792-7277
Technical Support: 480-792-7627
Web Address: <http://www.microchip.com>

Rocky Mountain

2355 West Chandler Blvd.
Chandler, AZ 85224-6199
Tel: 480-792-7966 Fax: 480-792-7456

Atlanta

500 Sugar Mill Road, Suite 200B
Atlanta, GA 30350
Tel: 770-640-0034 Fax: 770-640-0307

Boston

2 Lan Drive, Suite 120
Westford, MA 01886
Tel: 978-692-3848 Fax: 978-692-3821

Chicago

333 Pierce Road, Suite 180
Itasca, IL 60143
Tel: 630-285-0071 Fax: 630-285-0075

Dallas

4570 Westgrove Drive, Suite 160
Addison, TX 75001
Tel: 972-818-7423 Fax: 972-818-2924

Dayton

Two Prestige Place, Suite 130
Miamisburg, OH 45342
Tel: 937-291-1654 Fax: 937-291-9175

Detroit

Tri-Atria Office Building
32255 Northwestern Highway, Suite 190
Farmington Hills, MI 48334
Tel: 248-538-2250 Fax: 248-538-2260

Kokomo

2767 S. Albright Road
Kokomo, Indiana 46902
Tel: 765-864-8360 Fax: 765-864-8387

Los Angeles

18201 Von Karman, Suite 1090
Irvine, CA 92612
Tel: 949-263-1888 Fax: 949-263-1338

New York

150 Motor Parkway, Suite 202
Hauppauge, NY 11788
Tel: 631-273-5305 Fax: 631-273-5335

San Jose

Microchip Technology Inc.
2107 North First Street, Suite 590
San Jose, CA 95131
Tel: 408-436-7950 Fax: 408-436-7955

Toronto

6285 Northam Drive, Suite 108
Mississauga, Ontario L4V 1X5, Canada
Tel: 905-673-0699 Fax: 905-673-6509

ASIA/PACIFIC

Australia

Microchip Technology Australia Pty Ltd
Suite 22, 41 Rawson Street
Epping 2121, NSW
Australia
Tel: 61-2-9868-6733 Fax: 61-2-9868-6755

China - Beijing

Microchip Technology Consulting (Shanghai)
Co., Ltd., Beijing Liaison Office
Unit 915
Bei Hai Wan Tai Bldg.
No. 6 Chaoyangmen Beidajie
Beijing, 100027, No. China
Tel: 86-10-85282100 Fax: 86-10-85282104

China - Chengdu

Microchip Technology Consulting (Shanghai)
Co., Ltd., Chengdu Liaison Office
Rm. 2401, 24th Floor,
Ming Xing Financial Tower
No. 88 TIDU Street
Chengdu 610016, China
Tel: 86-28-6766200 Fax: 86-28-6766599

China - Fuzhou

Microchip Technology Consulting (Shanghai)
Co., Ltd., Fuzhou Liaison Office
Rm. 531, North Building
Fujian Foreign Trade Center Hotel
73 Wusi Road
Fuzhou 350001, China
Tel: 86-591-7557563 Fax: 86-591-7557572

China - Shanghai

Microchip Technology Consulting (Shanghai)
Co., Ltd.
Room 701, Bldg. B
Far East International Plaza
No. 317 Xian Xia Road
Shanghai, 200051
Tel: 86-21-6275-5700 Fax: 86-21-6275-5060

China - Shenzhen

Microchip Technology Consulting (Shanghai)
Co., Ltd., Shenzhen Liaison Office
Rm. 1315, 13/F, Shenzhen Kerry Centre,
Renminnan Lu
Shenzhen 518001, China
Tel: 86-755-2350361 Fax: 86-755-2366086

Hong Kong

Microchip Technology Hongkong Ltd.
Unit 901-6, Tower 2, Metroplaza
223 Hing Fong Road
Kwai Fong, N.T., Hong Kong
Tel: 852-2401-1200 Fax: 852-2401-3431

India

Microchip Technology Inc.
India Liaison Office
Divyasree Chambers
1 Floor, Wing A (A3/A4)
No. 11, O'Shaughnessey Road
Bangalore, 560 025, India
Tel: 91-80-2290061 Fax: 91-80-2290062

Japan

Microchip Technology Japan K.K.
Benex S-1 6F
3-18-20, Shinyokohama
Kohoku-Ku, Yokohama-shi
Kanagawa, 222-0033, Japan
Tel: 81-45-471-6166 Fax: 81-45-471-6122

Korea

Microchip Technology Korea
168-1, Youngbo Bldg. 3 Floor
Samsung-Dong, Kangnam-Ku
Seoul, Korea 135-882
Tel: 82-2-554-7200 Fax: 82-2-558-5934

Singapore

Microchip Technology Singapore Pte Ltd.
200 Middle Road
#07-02 Prime Centre
Singapore, 188980
Tel: 65-334-8870 Fax: 65-334-8850

Taiwan

Microchip Technology Taiwan
11F-3, No. 207
Tung Hua North Road
Taipei, 105, Taiwan
Tel: 886-2-2717-7175 Fax: 886-2-2545-0139

EUROPE

Denmark

Microchip Technology Nordic ApS
Regus Business Centre
Lautrup høj 1-3
Ballerup DK-2750 Denmark
Tel: 45 4420 9895 Fax: 45 4420 9910

France

Microchip Technology SARL
Parc d'Activite du Moulin de Massy
43 Rue du Saule Trapu
Batiment A - 1er Etage
91300 Massy, France
Tel: 33-1-69-53-63-20 Fax: 33-1-69-30-90-79

Germany

Microchip Technology GmbH
Gustav-Heinemann Ring 125
D-81739 Munich, Germany
Tel: 49-89-627-144 0 Fax: 49-89-627-144-44

Italy

Microchip Technology SRL
Centro Direzionale Colleoni
Palazzo Taurus 1 V. Le Colleoni 1
20041 Agrate Brianza
Milan, Italy
Tel: 39-039-65791-1 Fax: 39-039-6899883

United Kingdom

Arizona Microchip Technology Ltd.
505 Eskdale Road
Winnersh Triangle
Wokingham
Berkshire, England RG41 5TU
Tel: 44 118 921 5869 Fax: 44-118 921-5820

