



# TCA5550

## STEREO SOUND CONTROL SYSTEM

The TCA5550 is a single chip stereo balance, volume, bass and treble control circuit designed for use in car radios, TV, and audio systems. Simple dc inputs allow the control to be effected by four inexpensive potentiometers or a remote control system. The bass and treble responses are defined by a single capacitor per channel.

- Four High Impedance dc Controls — Vol, Bass, Treble, Balance
- A Single External Capacitor Defines Each Tone Control Characteristic
- Low Distortion, 0.1% at Nominal Input Level, Unity Gain with the Tone Controls Flat
- Channel Separation Better Than 45 dB
- Wide Power Supply Tolerance, 10 to 16 Vdc
- $\pm 14$  dB of Tone Control
- More Than 75 dB of Volume Control
- Wide Dynamic Range: 100 mV to 500 mV<sub>rms</sub> Input Signal
- Low Output Impedance

## STEREO SOUND CONTROL SYSTEM

SILICON MONOLITHIC INTEGRATED CIRCUIT

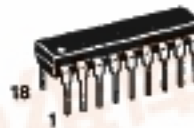

P SUFFIX  
PLASTIC PACKAGE  
CASE 707-02

FIGURE 1 — BLOCK DIAGRAM

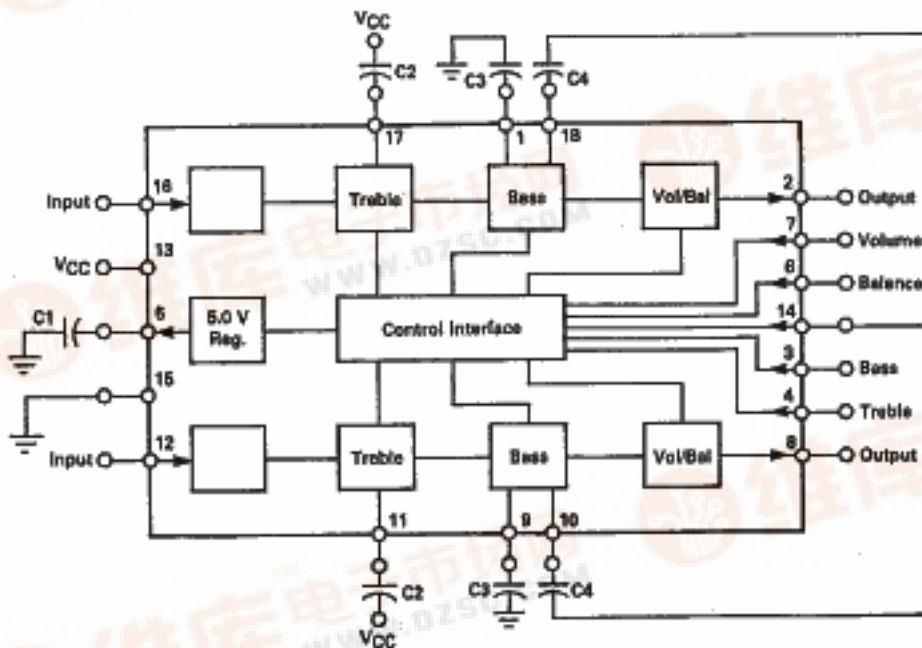

MAXIMUM RATINGS ( $T_A = +25^\circ\text{C}$ )

| Rating   | Value       | Unit        |
|--|-------------|-------------|
| Power Supply Voltage   | 18          | Volts       |
| Power Dissipation (Package Limitation)<br>Derate above $T_A = +25^\circ\text{C}$ | 1250<br>10  | mW<br>mW/°C |
| Operating Temperature Range (Ambient)  | -40 to +85  | °C          |
| Storage Temperature Range  | -65 to +150 | °C          |

ELECTRICAL CHARACTERISTICS ( $T_A = 25^\circ\text{C}$ ,  $V_{CC} = 12\text{ Vdc}$ )

| Characteristic   | Pin        | Min | Typ      | Max       | Unit                |
|--|------------|-----|----------|-----------|---------------------|
| Supply Voltage   | 13         | 10  | —        | 18        | Vdc                 |
| Supply Current $I_s$   |            |     | 30<br>15 | —         | mA                  |
| Regulated Output Voltage <sup>1</sup>                                | 5          | —   | 5.0      | —         | V                   |
| Current  |            |     | —        | 3.0       | mA                  |
| Input Levels   |            |     |          |           | mV <sub>rms</sub>   |
| Max Gain   | 12, 16     | —   | 100      | —         |                     |
| With Reduced Gain <sup>2</sup>                                       |            |     | —        | 500       |                     |
| Input Impedance  | 12, 16     | —   | 100      | —         | k $\Omega$          |
| Output Impedance   | 2, 8       | —   | 300      | —         | $\Omega$            |
| Tone Control Range (at 70 Hz & 10 kHz) <sup>2</sup>                  | 3, 4       | —   | —        | —         | dB                  |
| With Pins 3 & 4 @ 0.5 V  |            |     | -14      | —         |                     |
| With Pins 3 & 4 @ 2.3 V  |            |     | 0        | —         |                     |
| With Pins 3 & 4 @ 4.1 V  |            |     | +14      | —         |                     |
| Balance Control Range  | 6          | —   | —        | —         | dB                  |
| (Constant Power Law)   |            |     | +3.0     | —         | dB                  |
| Voltage on Pin 6 for Balanced Gain                                   |            |     | 2.3      | —         | V                   |
| Volume Control Range   | 7          | —   | 80       | —         | dB                  |
| With Pin 7 @ 0 V   |            |     | +10      | —         |                     |
| With Pin 7 @ 3.1 V   |            |     | -20      | —         |                     |
| With Pin 7 @ $V_{PIN 6}$   |            |     | -70      | —         |                     |
| Control Input Currents   | 3, 4, 6, 7 | —   | —        | $\pm 1.0$ | $\mu\text{A}$       |
| Channel Separation   |            | 45  | —        | —         | dB                  |
| Distortion (at 1.0 kHz) at 300 mV <sub>rms</sub> Output <sup>3</sup> |            | —   | 0.1      | —         | %                   |
| Signal : Noise Ratio   |            | —   | 70       | —         | dB                  |
| 50 Hz to 15 kHz, 10 dB Gain, Tone Controls Flat                      |            |     |          |           |                     |
| Noise Level  |            | —   | 80       | —         | $\mu\text{V}_{rms}$ |
| 50 Hz to 15 kHz, Min Gain  |            |     |          |           |                     |

## NOTES:

- The control potentiometers to this point, see Figure 7.
- These figures are functions of the capacitors on Pins 1, 5, 10, 11, 17 & 18. See the application diagram, Figure 7.
- The input level may be increased to 500 mV<sub>rms</sub> but the user controls must be adjusted to ensure that the output level does not exceed 300 mV<sub>rms</sub>.

T-77-05-09

PERFORMANCE CHARACTERISTICS, FIGURES 2-7, TAKEN IN CIRCUIT OF FIGURE 8,  $V_{CC} = 12\text{ V}$

FIGURE 2 — MIDBAND DISTORTION

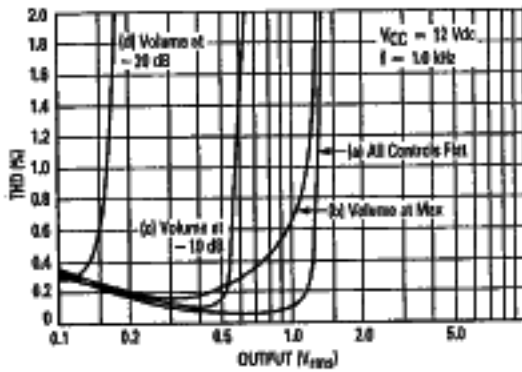

FIGURE 3 — VOLUME CONTROL CHARACTERISTICS

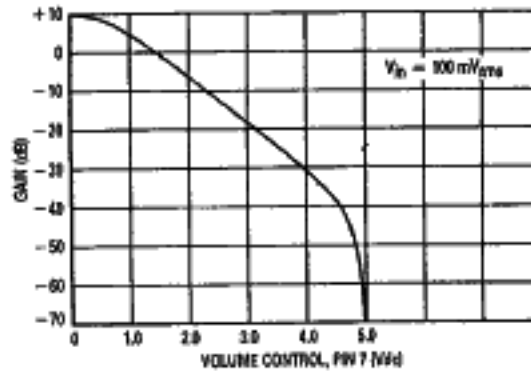

FIGURE 4 — TONE CONTROL CHARACTERISTICS

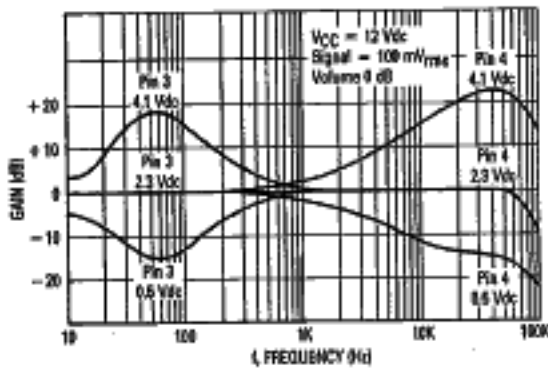

FIGURE 5 — HIGH FREQUENCY DISTORTION

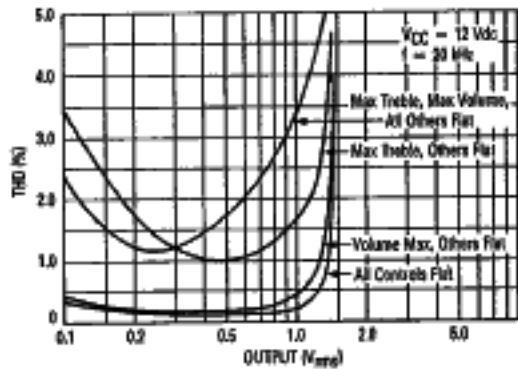

FIGURE 6 — LOW FREQUENCY DISTORTION

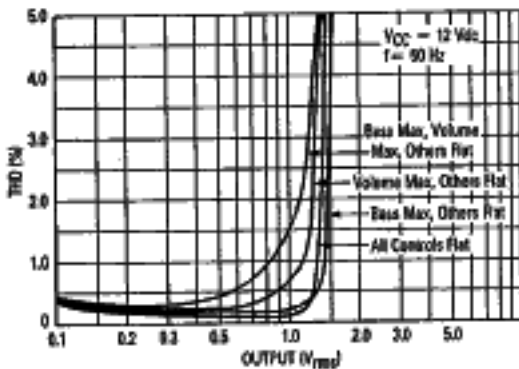
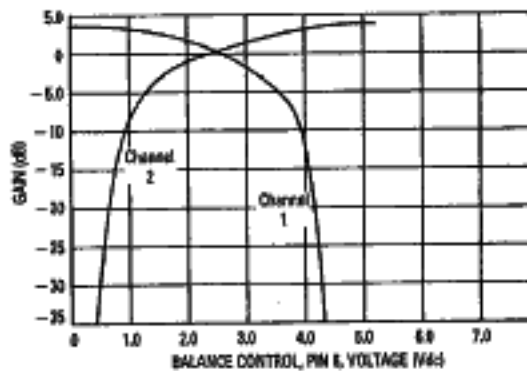
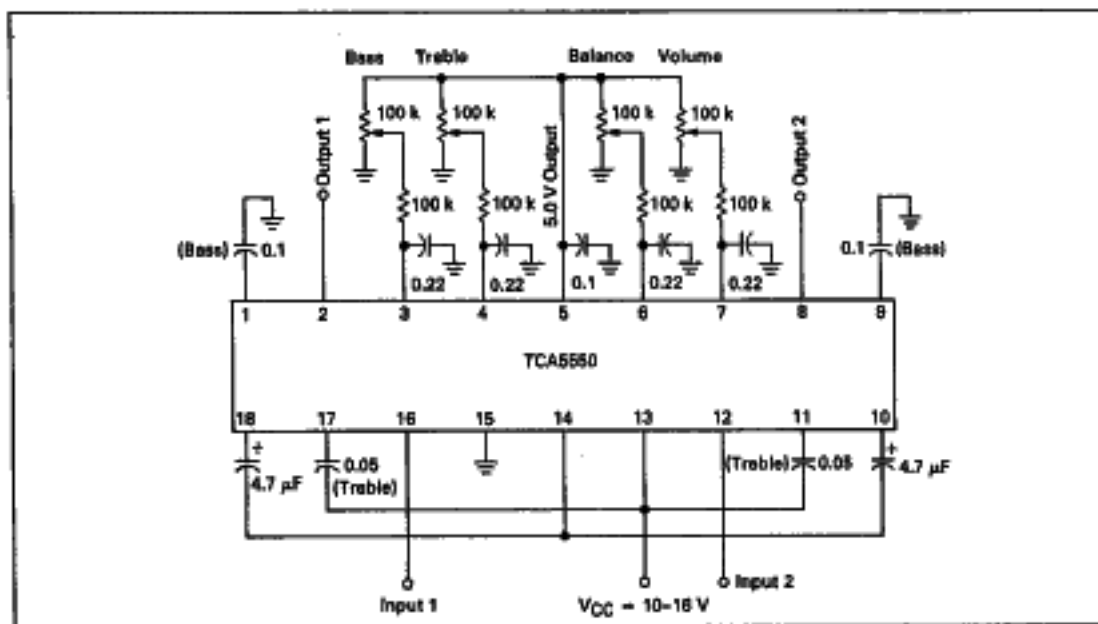

FIGURE 7 — BALANCE CONTROL CHARACTERISTIC



T-77-05-09

FIGURE 8 — APPLICATION CIRCUIT



9