

TOSHIBA

TCD1502D

TOSHIBA CCD LINEAR IMAGE SENSOR CCD (Charge Coupled Device)

TCD1502D

The TCD1502D is a high sensitive and low dark current 5000 elements CCD image sensor.

The sensor is designed for facsimile, imagescanner and OCR.

The device contains a row of 5000 elements photodiodes which provide a 16 lines/mm (400DPI) across a A3 size paper. The device is operated by 5 V (pulse), and 12 V power supply.

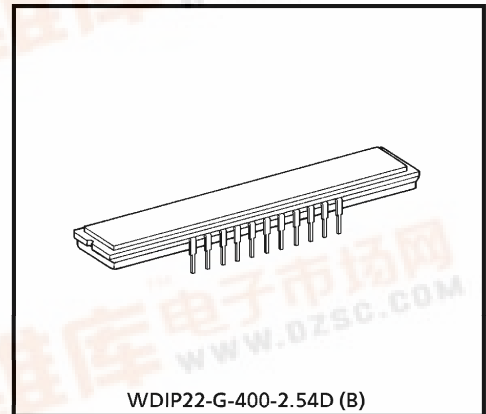

WDIP22-G-400-2.54D (B)

Weight : 5.2 g (Typ.)

FEATURES

- Number of Image Sensing Elements : 5000 elements
- Image Sensing Element Size : 7 μm by 7 μm on 7 μm centers
- Photo Sensing Region : High sensitive and low voltage dark signal pn photodiode
- Clock : 2 phase (5 V)
- Package : 22 pin Cerdip

MAXIMUM RATINGS (Note 1)

CHARACTERISTIC	SYMBOL	RATING	UNIT
Clock Pulse Voltage	V_{ϕ}	- 0.3~8	V
Shift Pulse Voltage	V_{SH}		
Reset Pulse Voltage	V_{RS}		
Clamp Pulse Voltage	V_{CP}		
Power Supply Voltage	V_{OD}	- 0.3~15	
Operating Temperature	T_{opr}	- 25~60	°C
Storage Temperature	T_{stg}	- 40~100	°C

(Note 1) : All voltage are with respect to SS terminals (Ground).

PIN CONNECTIONS

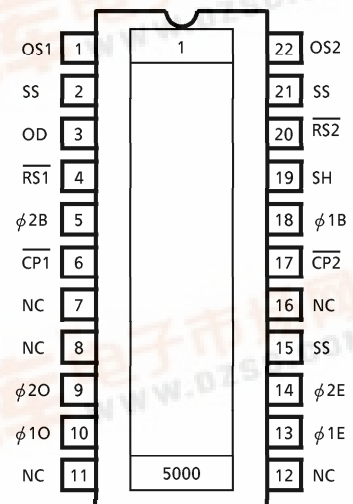

(TOP VIEW)

980910EBA2

- TOSHIBA is continually working to improve the quality and the reliability of its products. Nevertheless, semiconductor devices in general can malfunction or fail due to their inherent electrical sensitivity and vulnerability to physical stress. It is the responsibility of the buyer, when utilizing TOSHIBA products, to observe standards of safety, and to avoid situations in which a malfunction or failure of a TOSHIBA product could cause loss of human life, bodily injury or damage to property. In developing your designs, please ensure that TOSHIBA products are used within specified operating ranges as set forth in the most recent products specifications. Also, please keep in mind the precautions and conditions set forth in the TOSHIBA Semiconductor Reliability Handbook.
- The products described in this document are subject to the foreign exchange and foreign trade laws.
- The information contained herein is presented only as a guide for the applications of our products. No responsibility is assumed by TOSHIBA CORPORATION for any infringements of intellectual property or other rights of the third parties which may result from its use. No license is granted by implication or otherwise under any intellectual property or other rights of TOSHIBA CORPORATION or others.
- The information contained herein is subject to change without notice.

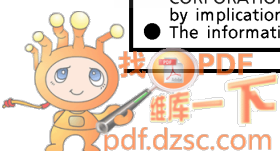

CIRCUIT DIAGRAM

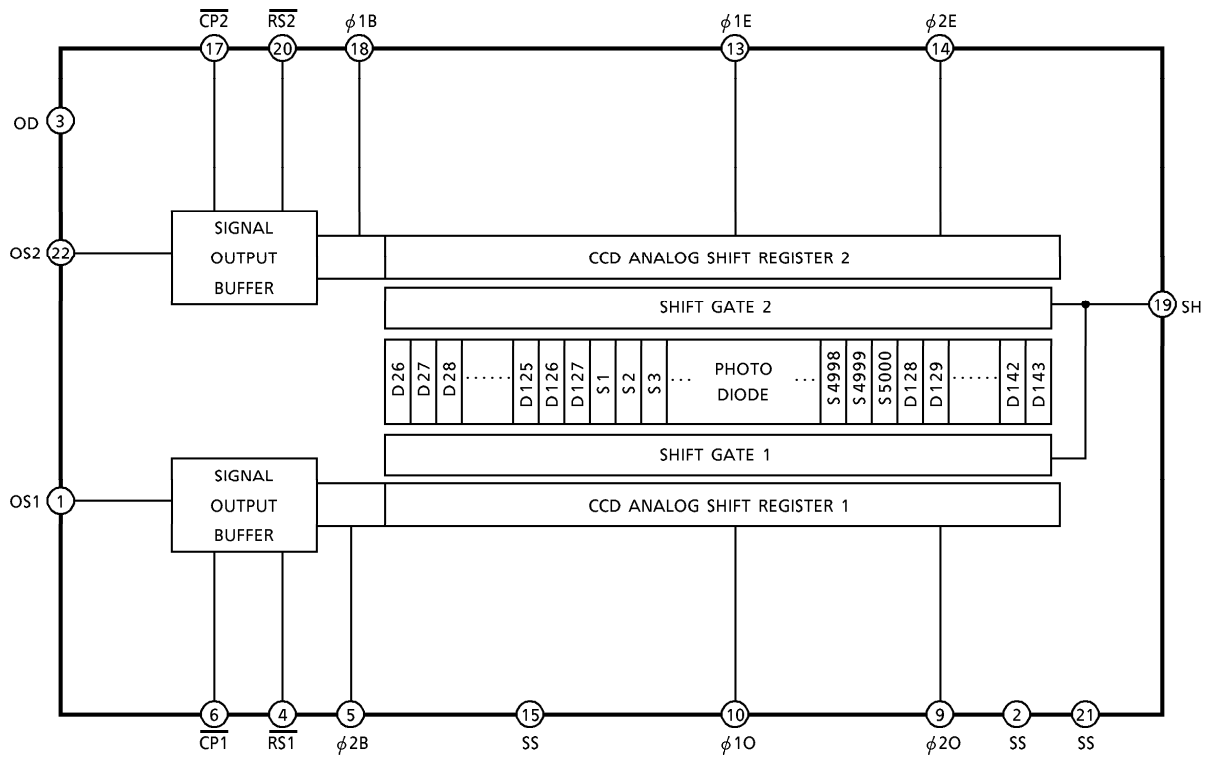

PIN NAME

$\phi 1E, O$	Clock (Phase 1)
$\phi 2E, O$	Clock (Phase 2)
$\phi 1B$	Final Stage Clock (Phase 1)
$\phi 2B$	Final Stage Clock (Phase 2)
SH	Shift Gate
RS	Reset Gate
CP	Clamp Gate
OS1	Signal Output 1
OS2	Signal Output 2
OD	Power
SS	Ground
NC	Non Connection

OPTICAL / ELECTRICAL CHARACTERISTICS(Ta = 25°C, V_{OD} = 12 V, V_φ = V_{SH} = V_{RS} = V_{CP} = 5 V, f_φ = 1 MHz,t_{INT} (INTEGRATION TIME) = 10 ms, LIGHT SOURCE = DAYLIGHT FLUORESCENT LAMP,

LOAD RESISTANCE = 100 kΩ)

CHARACTERISTIC	SYMBOL	MIN.	TYP.	MAX.	UNIT	NOTE
Sensitivity	R	7.2	9	10.8	V / lx·s	
Photo Response Non Uniformity	PRNU	—	—	10	%	(Note 2)
	PRNU (3)	—	4	8	mV	(Note 8)
Saturation Output Voltage	V _{SAT}	1.5	2	—	V	(Note 3)
Saturation Exposure	SE	0.14	0.22	—	lx·s	(Note 4)
Dark Signal Voltage	V _{DRK}	—	1	2.5	mV	(Note 5)
Dark Signal Non Uniformity	DSNU	—	1	2.5	mV	(Note 5)
DC Power Dissipation	P _D	—	300	364	mW	
Total Transfer Efficiency	TTE	92	—	—	%	
Output Impedance	Z _o	—	0.5	1	kΩ	
Dynamic Range	DR	—	2000	—	—	(Note 6)
DC Signal Output Voltage	V _{OS1}	3.5	4.5	6	V	(Note 7)
	V _{OS2}	3.5	4.5	6		
DC Differential Error Voltage	V _{OS1} -V _{OS2}	—	—	300	mV	

(Note 2) : Measured at 50% of SE (Typ.)

$$\text{Definition of PRNU : PRNU} = \frac{\Delta\bar{x}}{\bar{x}} \times 100 (\%)$$

Where \bar{x} is average of total signal outputs and $\Delta\bar{x}$ is maximum deviation from \bar{x} under uniform illumination. (Channel 1)

In the case of 2500 elements (Channel 2), the condition is the same as above too.

(Note 3) : V_{SAT} is defined as minimum saturation output voltage of all effective pixels.(Note 4) : Definition of SE : SE = $\frac{V_{SAT}}{R}$ (lx·s)

(Note 5) : V_{DRK} is defined as average dark signal voltage of all effective pixels.
 $DSNU$ is defined as different voltage between V_{DRK} and V_{MDK} when V_{MDK} is maximum dark signal voltage.

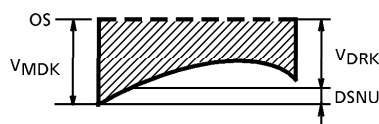

(Note 6) : Definition of DR : $DR = \frac{V_{SAT}}{V_{DRK}}$

V_{DRK} is proportional to t_{INT} (Integration Time).
 So the shorter t_{INT} condition makes wider DR values.

(Note 7) : DC signal output voltage and DC compensation output voltage are defined as follows:

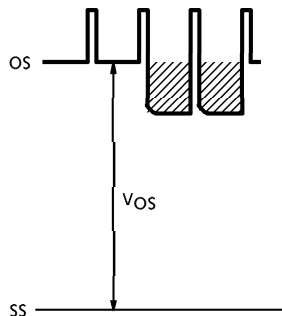

(Note 8) : PRNU (3) is defined as maximum voltage with next pixel, where measured 5% of SE (Typ.)

OPERATING CONDITION

CHARACTERISTIC		SYMBOL	MIN.	TYP.	MAX.	UNIT
Clock Pulse Voltage	"H" Level	$V_{\phi 1E, O}$	4.5	5	5.5	V
	"L" Level	$V_{\phi 2E, O}$	0	—	0.5	
Final Stage Clock Voltage	"H" Level	$V_{\phi 1B}$	4.5	5	5.5	V
	"L" Level	$V_{\phi 2B}$	0	—	0.5	
Shift Pulse Voltage	"H" Level	V_{SH}	4.5	5	5.5	V
	"L" Level		0	—	0.5	
Reset Pulse Voltage	"H" Level	$\overline{V_{RS1}}$	4.5	5	5.5	V
	"L" Level	$\overline{V_{RS2}}$	0	—	0.5	
Clamp Pulse Voltage	"H" Level	$\overline{V_{CP1}}$	4.5	5	5.5	V
	"L" Level	$\overline{V_{CP2}}$	0	—	0.5	
Power Supply Voltage		V_{OD}	11.4	12.0	13.0	V

CLOCK CHARACTERISTICS (Ta = 25°C)

CHARACTERISTIC	SYMBOL	MIN.	TYP.	MAX.	UNIT
Clock Pulse Frequency	f_{ϕ}	—	1	10	MHz
Reset Pulse Frequency	$\overline{f_{RS}}$	—	1	10	MHz
Clock Capacitance	$C_{\phi E}$	—	350	450	pF
	$C_{\phi O}$	—	350	450	
Final Stage Clock Capacitance	$C_{\phi B}$	—	10	20	pF
Shift Gate Capacitance	C_{SH}	—	10	20	pF
Reset Gate Capacitance	$\overline{C_{RS}}$	—	10	20	pF
Clamp Gate Capacitance	$\overline{C_{CP}}$	—	10	20	pF

TIMING CHART

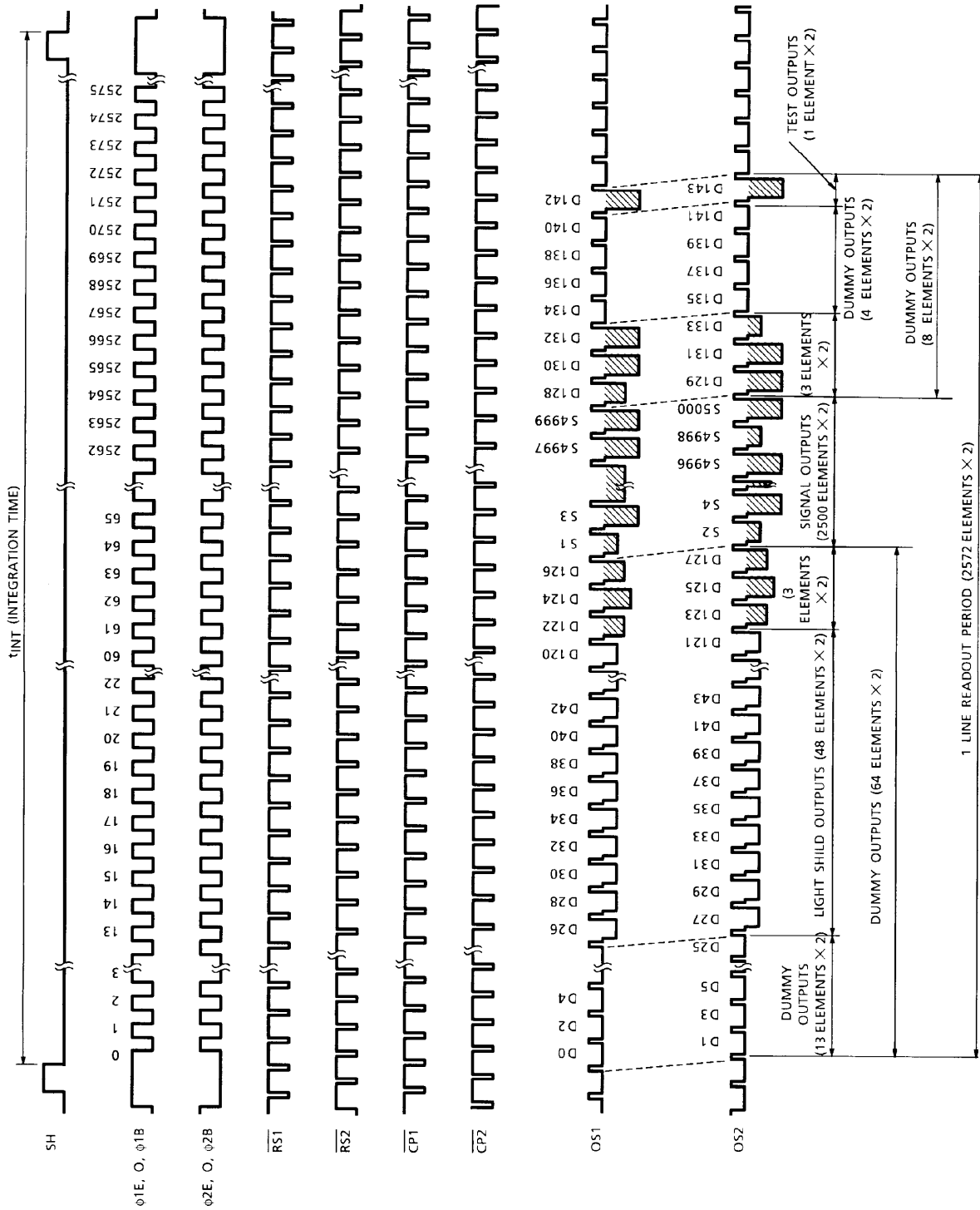

TIMING REQUIREMENTS

SH, $\phi 1$ Timing

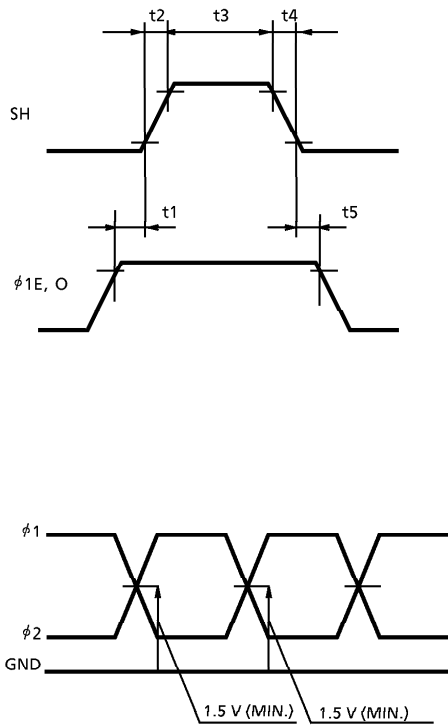

$\phi 1, \phi 2, \overline{RS}, \overline{CP}, OS$ Timing

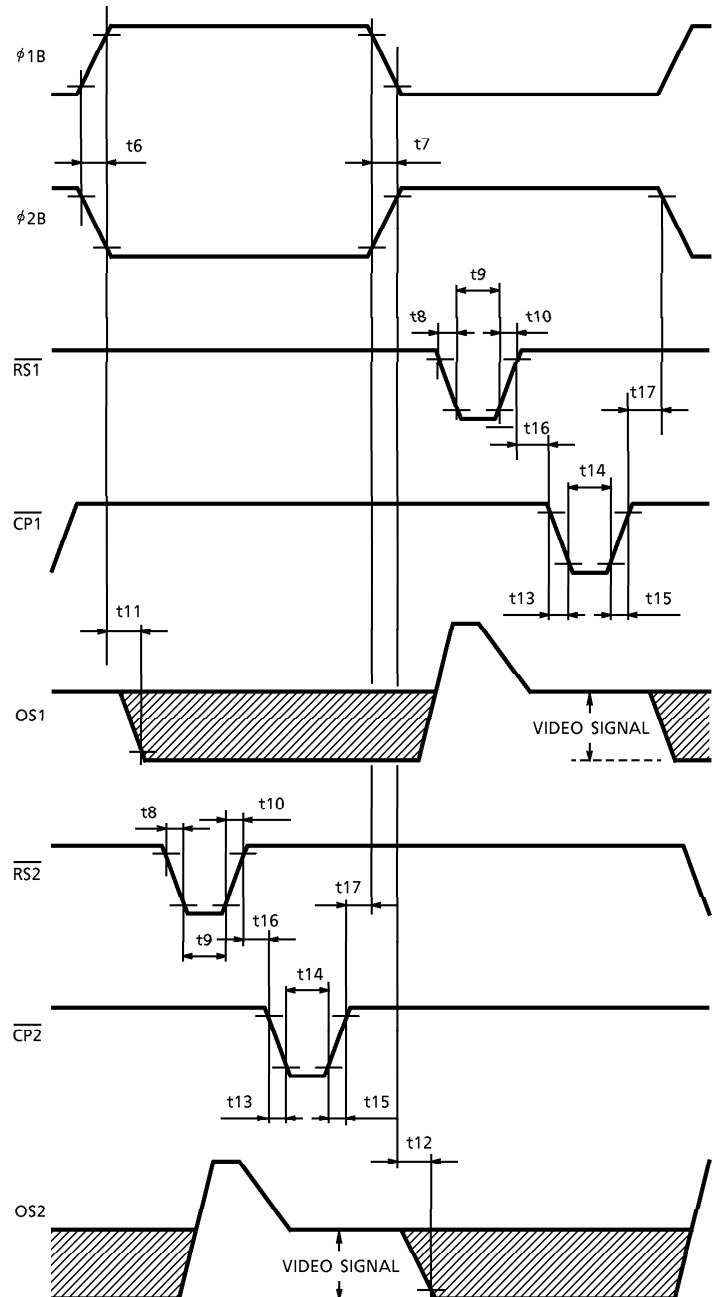

CHARACTERISTIC	SYMBOL	MIN.	TYP. (Note 9)	MAX.	UNIT
Pulse Timing of SH and ϕ_{10}, E	t1, t5	100	300	—	ns
SH Pulse Rise Time, Fall Time	t2, t4	0	50	—	ns
SH Pulse Width	t3	500	1000	—	ns
ϕ_1, ϕ_2 Pulse Rise Time, Fall Time	t6, t7	0	100	—	ns
\overline{RS} Pulse Rise Time, Fall Time	t8, t10	0	20	—	ns
\overline{RS} Pulse Width	t9	20	250	—	ns
Video Data Delay Time (Note 10)	t11, t12	—	20	—	ns
\overline{CP} Pulse Rise Time, Fall Time	t13, t15	0	20	—	ns
\overline{CP} Pulse Width	t14	20	—	—	ns
Pulse Timing of \overline{RS} and \overline{CP}	t16	0	—	—	ns
Pulse Timing of ϕ_{1B}, ϕ_{2B} and \overline{CP}	t17	0	—	—	ns

(Note 9) : TYP. is the case of $f_{RS} = 1.0$ MHz

(Note 10) : Load Resistance is 100 k Ω

TYPICAL PERFORMANCE CURVES

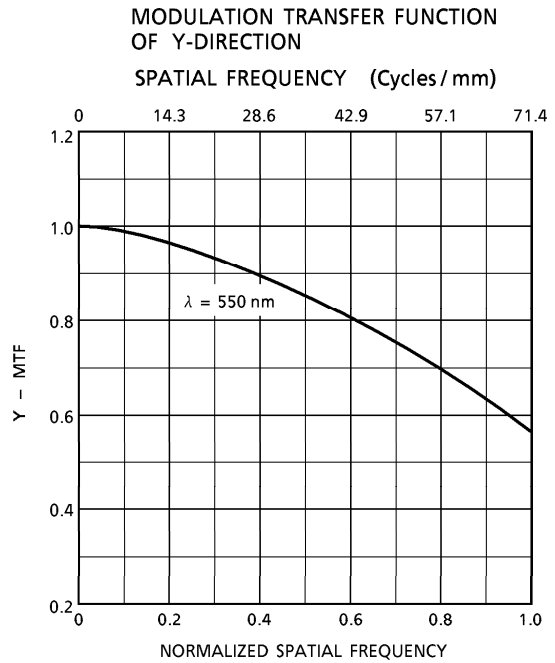
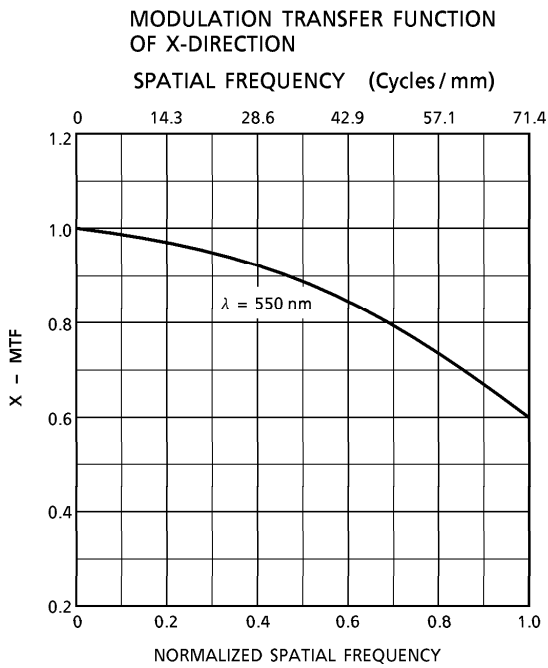
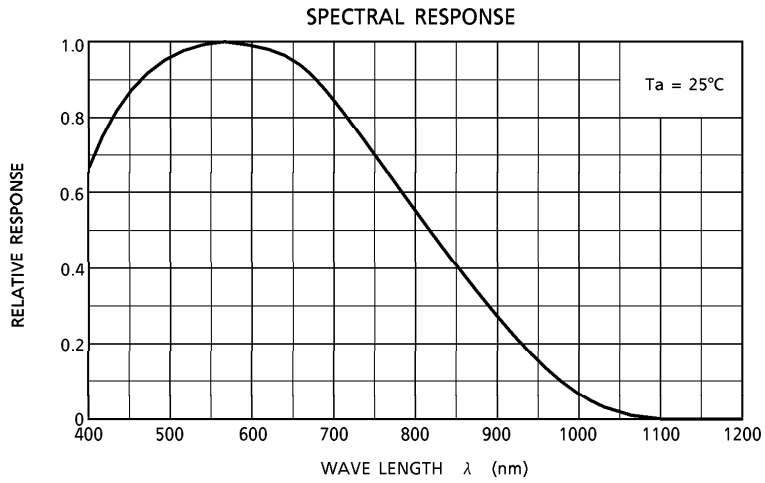

TYPICAL PERFORMANCE CURVES (Cont'd)

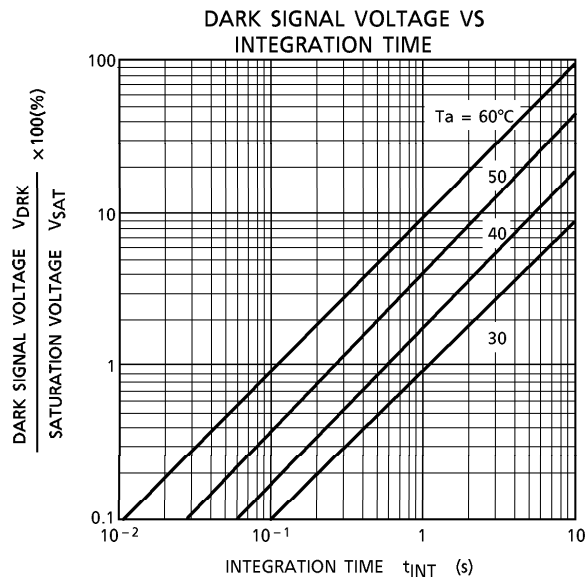
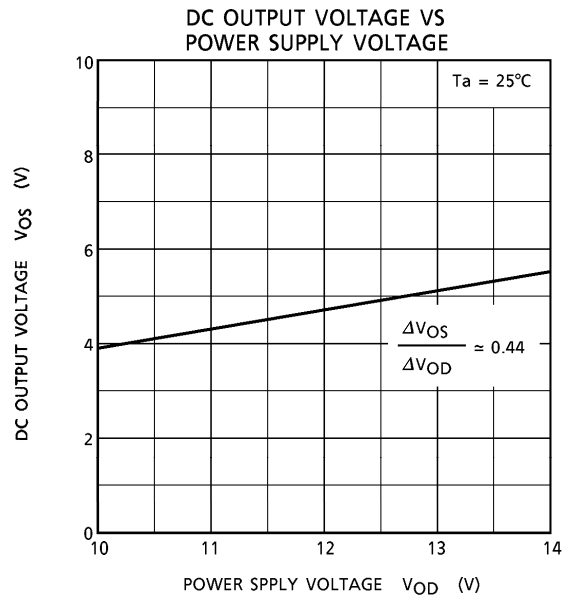
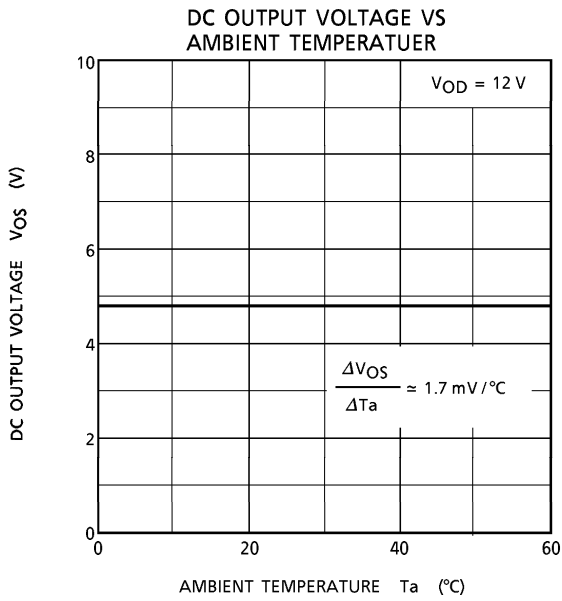

PRECAUTIONS FOR USE OF CCD IMAGE SENSOR**1. Static Electricity**

This device has some weakly terminals for static electricity. Therefore, please pay attention to treat this device.

CCD Image Sensor is protected against static electricity, but inferior puncture mode device due to static electricity is sometimes detected. In handling the device, it is necessary to execute the following static electricity preventive measures, in order to prevent the trouble rate increase of the manufacturing system due to static electricity.

- a. Prevent the generation of static electricity due to friction by making the work with bare hands or by putting on cotton gloves and non-charging working clothes.
- b. Discharge the static electricity by providing earth plate or earth wire on the floor, door or stand of the work room.
- c. Ground the tools such as soldering iron, radio cutting plier or pincette.

It is not necessarily required to execute all precaution items for static electricity.

It is all right to mitigate the precautions by confirming that the trouble rate within the prescribed range.

2 Window Glass

As the dust and station on the glass window of the package will cause black flow on the picture, never fail to clean the glass surface before using. (Blow compressed vapor, and wipe off the dust, and dirt with soft cloth or paper slightly moistened with alcohol).

Fully take care for the handling of the device as the window glass will break or a strong friction is given to the window glass surface.

3. Incident Light

CCD image sensor has sensitivity in a wide range zone of light wave length, but its characteristics will sometimes widely change when used with long wave length input light outside the visual light zone.

PACKAGE OUTLINE
WDIP22-G-400-2.54D (B)

Unit in mm

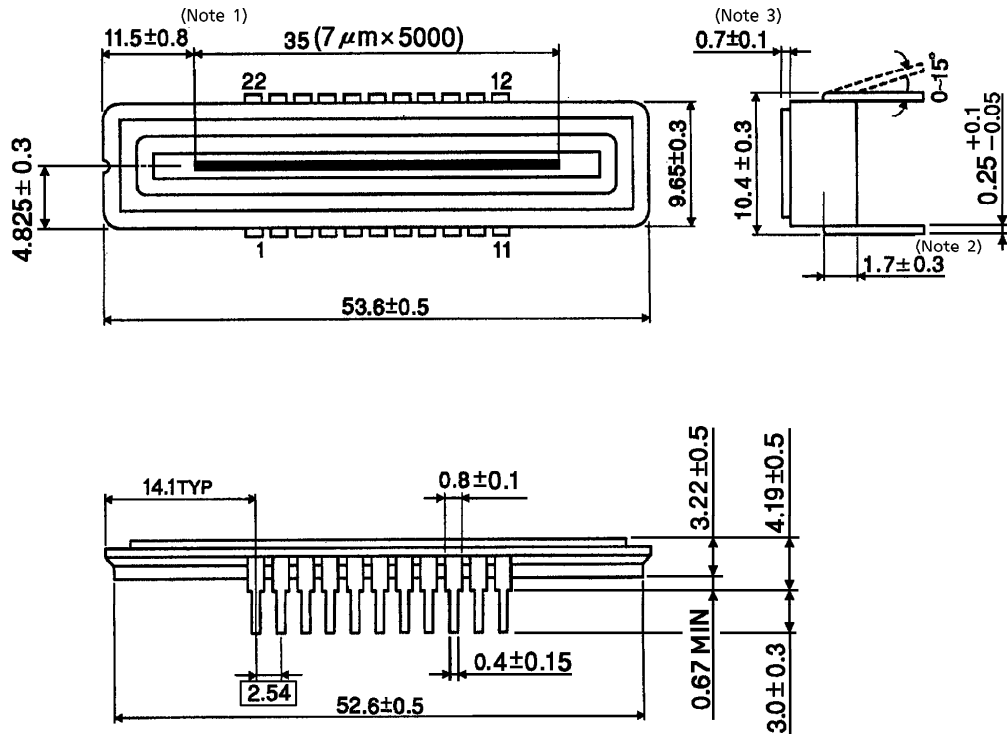

- (Note 1) : No. 1 SENSOR ELEMENT (S1) TO EDGE OF PACKAGE.
- (Note 2) : TOP OF CHIP TO BOTTOM OF PACKAGE.
- (Note 3) : GLASS THICKNES (n = 1.5)

Weight : 5.2 g (Typ.)