

**Optoelectronic Interrupter with Schmitt-Trigger Output Logic**

**Construction:** Emitter: GaAs IR Emitting Diode  
Detector: Integrated Optoelectronic Circuit

**Applications:** Contactless optoelectronic switching and monitoring

**Features:**

- Output: active "HIGH"
- Buffer- open collector
- TTL compatible
- Small dimensions
- Case plastic polycarbonate- protected against ambient light
- No adjustment
- Four package variations
- Two aperture variations

**Pin connections**

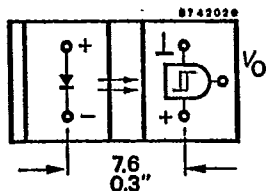

**Dimensions in mm**

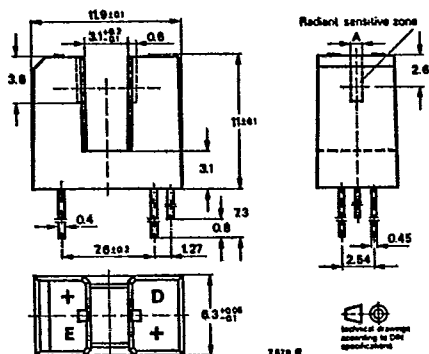

For printed board construction:  
 TCSS 111. with aperture  
 1.00 mm (0.04")  
 TCSS 121. with aperture  
 0.50 mm (0.02")  
 Weight max. 0.9 g

**Note:** Fourth number of type designation:  $I_{FT}$  group

T1.2/1189.1285 E2

T-41-73

TCSS 111. up to TCSS 421.

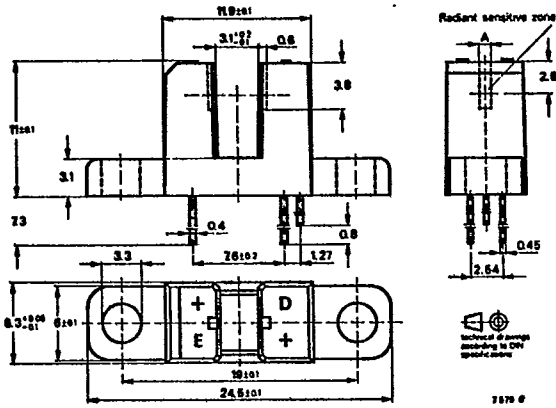

With mounting flange on both sides:  
 TCSS 211. with aperture 1.00 mm (0.04")  
 TCSS 221. with aperture 0.50 mm (0.02")  
 Weight max. 1.0 g

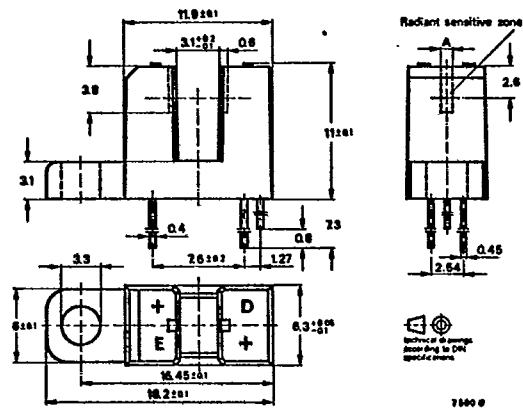

With mounting flange on emitter side:  
 TCSS 311. with aperture 1.00 mm (0.04")  
 TCSS 321. with aperture 0.50 mm (0.02")  
 Weight max. 0.95 g

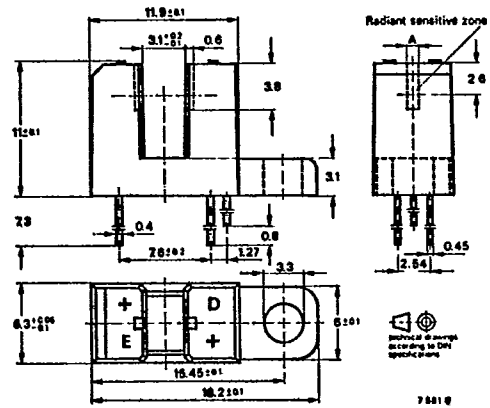

With mounting flange on detector side:  
 TCSS 411. with aperture 1.00 mm (0.04")  
 TCSS 421. with aperture 0.50 mm (0.02")  
 Weight max. 0.95 g

Note: Fourth number type designation: /<sub>F<sub>T</sub></sub> group

## TCSS 111. up to TCSS 421.

T-41-73

## Absolute maximum ratings

## Emitter

Reverse voltage	$V_R$	6	V
Forward current	$I_F$	60	mA
Forward surge current $t_p \leq 10 \mu s$	$I_{FSM}$	3	A
Power dissipation $T_{amb} \leq 25^\circ C$	$P_V$	100	mW
Junction temperature	$T_J$	100	$^\circ C$

## Detector

Supply voltages	$V_{S1}$	6.5	V
	$V_{S2}$	18	V
Output current	$I_O$	20	mA
Power dissipation $T_{amb} \leq 25^\circ C$	$P_V$	250	mW
Junction temperature	$T_J$	100	$^\circ C$

## Coupled device

Total power dissipation $T_{amb} \leq 25^\circ C$	$P_{tot}$	350	mW
Ambient temperature range	$T_{amb}$	-25...+85	$^\circ C$
Storage temperature range	$T_{stg}$	-40...+100	$^\circ C$
Soldering temperature 2 mm from case, $t \leq 5$ s	$T_{sd}$	260	$^\circ C$

## Electrical characteristics

 $T_{amb} = 25^\circ C$ 

## Emitter

		Min.	Typ.	Max.	
Forward voltage $I_F = 50$ mA	$V_F$		1.25	1.6	V
Breakdown voltage $I_R = 100 \mu A$	$V_{(BR)}$	6			V
Junction capacitance $V_R = 0, f = 1$ MHz	$C_j$		50		pF

## Detector

Supply voltage ranges	$V_{S1}$	4.75	5.25	V
	$V_{S2}$	4	16	V

## Coupled device

Supply current $V_O = V_{OH}, I_F \geq I_{TF}$	$I_{S1}$	12	mA
$I_F = 0$	$I_{S1}$	16	mA

T-41-73

TCSS 111. up to TCSS 421.

	Min.	Typ.	Max.	
Output current $V_{S2} = 16\text{ V}, I_F \geq I_{FT}$			100	$\mu\text{A}$
Input threshold current				
	TCSS 1110...TCSS 4110	10	20	mA
	TCSS 1211...TCSS 4211	15	30	mA
Hysteresis $R_L = 270\ \Omega$		20		%
Output voltage $I_{OL} = 1.2\text{ mA}, I_F = 0$		0.3	0.4	V
Switching frequency $I_F \geq I_{FT}, R_L = 270\ \Omega$		400		kHz
<b>Switching characteristics</b>				
$V_{S1} = V_{S2} = 5\text{ V}, I_F = 3 \times I_{FT}, R_L = 270\ \Omega,$ see test circuit				
Rise time		30		ns
Turn on time		0.5		$\mu\text{s}$
Fall time		10		ns
Turn off time		1.8		$\mu\text{s}$

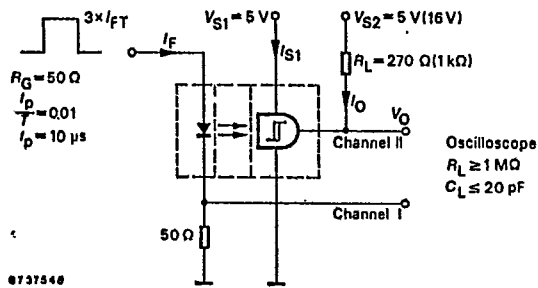

Fig. 1 Test circuit

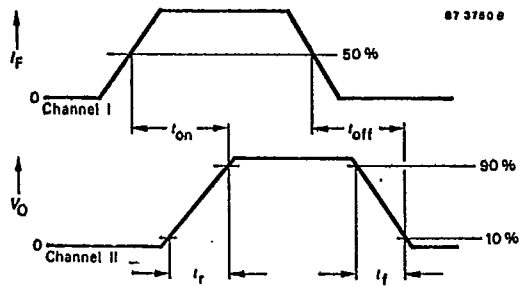

Fig. 2 Pulse diagram

TCSS 111. up to TCSS 421.

T-41-73

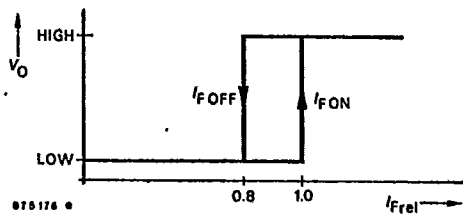
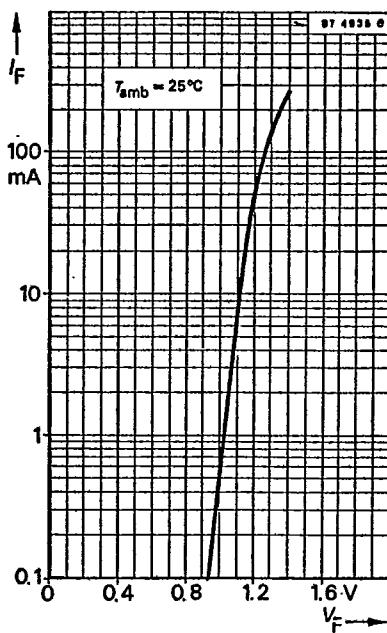
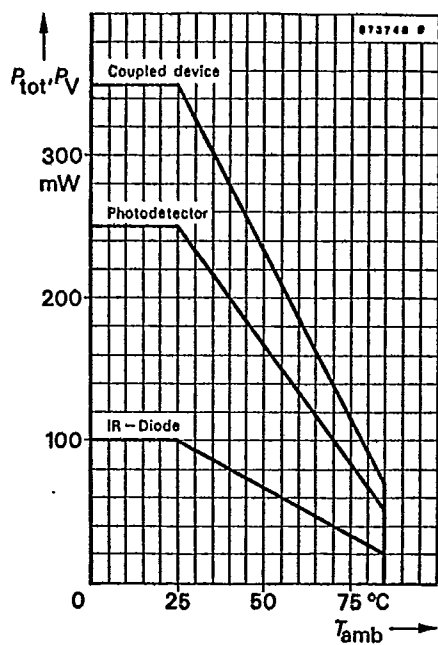
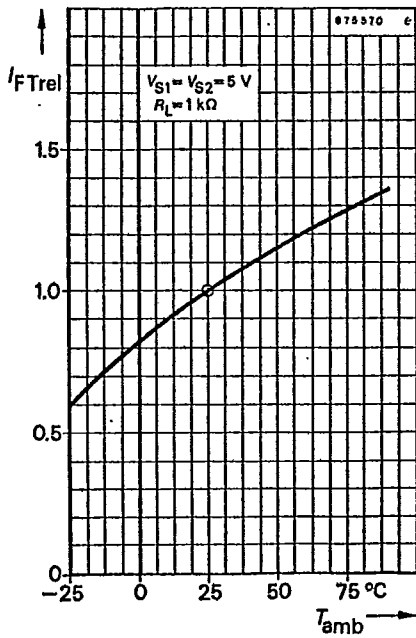
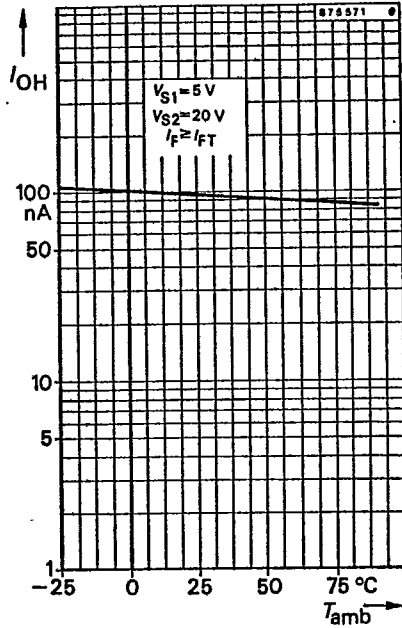
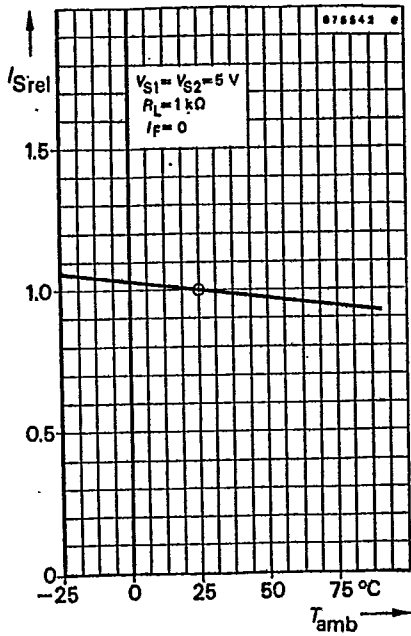

Fig. 3 Hysteresis



TCSS 111. up to TCSS 421.

T-41-73



Copyright © Each Manufacturing Company.

All Datasheets cannot be modified without permission.

This datasheet has been download from :

[www.AllDataSheet.com](http://www.AllDataSheet.com)

100% Free DataSheet Search Site.

Free Download.

No Register.

Fast Search System.

[www.AllDataSheet.com](http://www.AllDataSheet.com)