



TCVT1300

Vishay Telefunken

Dual Channel Transmissive Optical Sensor with Phototransistor Output

Description

This device has a compact construction where the emitting-light sources and the detectors are located face-to-face on the same optical axes. The operating wavelength is 950 nm.

The detectors consists of a phototransistors. The distance of both channels is 2.66 mm.

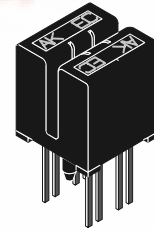

95 10530

Applications

- Accurate position sensor for shaft encoder
- Detection of opaque material such as paper, IBM cards, magnetic tapes etc.
- Detection for motion direction

Features

- Channel 1 to channel 2 distance 2.66 mm (optical center)
- Gap 1.5 mm
- Package height: 10 mm
- Plastic polycarbonate housing
- Aperture 0.2 mm for both channels
- Current Transfer Ratio (CTR) of typical 2%

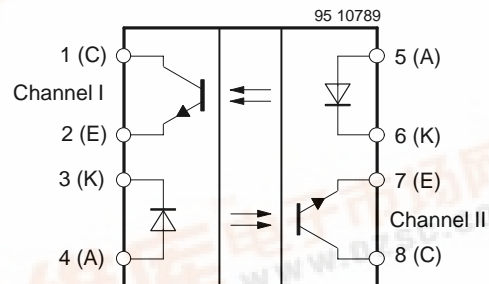

Note: Thermal dot indicates channel 1

Order Instruction

Ordering Code	Resolution (mm) / Aperture (mm)	Remarks
TCVT1300	/ 0.2	Dual channel



TCVT1300

Vishay Telefunken



Absolute Maximum Ratings

Input (Emitter)

Parameter	Test Conditions	Symbol	Value	Unit
Reverse voltage		V_R	5	V
Forward current		I_F	50	mA
Forward surge current	$t_p \leq 10 \mu\text{s}$	I_{FSM}	3	A
Power dissipation	$T_{amb} \leq 25^\circ\text{C}$	P_V	100	mW
Junction temperature		T_j	100	$^\circ\text{C}$

Output (Detector)

Parameter	Test Conditions	Symbol	Value	Unit
Collector emitter voltage		V_{CEO}	70	V
Emitter collector voltage		V_{ECO}	7	V
Collector current		I_C	50	mA
Power dissipation	$T_{amb} \leq 25^\circ\text{C}$	P_V	100	mW
Junction temperature		T_j	100	$^\circ\text{C}$

Coupler

Parameter	Test Conditions	Symbol	Value	Unit
Total power dissipation	$T_{amb} \leq 25^\circ\text{C}$	P_{tot}	200	mW
Operation temperature range		T_{amb}	-25 to +85	$^\circ\text{C}$
Storage temperature range		T_{stg}	-25 to +100	$^\circ\text{C}$
Soldering temperature	2 mm from case, $t \leq 5 \text{ s}$	T_{sd}	260	$^\circ\text{C}$



Electrical Characteristics ($T_{amb} = 25^{\circ}\text{C}$)

Input (Emitter)

Parameter	Test Conditions	Symbol	Min.	Typ.	Max.	Unit
Forward voltage	$I_F = 30 \text{ mA}$	V_F		1.20	1.3	V
Junction capacitance	$V_R = 0, f = 1 \text{ MHz}$	C_j		50		pF

Output (Detector)

Parameter	Test Conditions	Symbol	Min.	Typ.	Max.	Unit
Collector emitter voltage	$I_C = 1 \text{ mA}$	V_{CEO}	70			V
Emitter collector voltage	$I_E = 100 \mu\text{A}$	V_{ECO}	7			V
Collector dark current	$V_{CE} = 25 \text{ V}, I_F = 0, E = 0$	I_{CEO}		10	200	nA

Coupler

Parameter	Test Conditions	Symbol	Min.	Typ.	Max.	Unit
Collector current per channel	$V_{CE} = 10 \text{ V}, I_F = 30 \text{ mA}$	I_C	400		1300	μA
Collector emitter saturation voltage	$I_F = 30 \text{ mA}, I_C = 0.1 \text{ mA}$	V_{CEsat}			0.2	V
Crosstalk	$V_{CE} = 10 \text{ V}, I_{F1} = 0, I_{F2} = 30 \text{ mA}$	I_{CX1}			15	μA
	$V_{CE} = 10 \text{ V}, I_{F1} = 30 \text{ mA}, I_{F2} = 0$	I_{CX2}			15	μA
Phase angle	(see figure 1)	Phi		90		$^{\circ}$

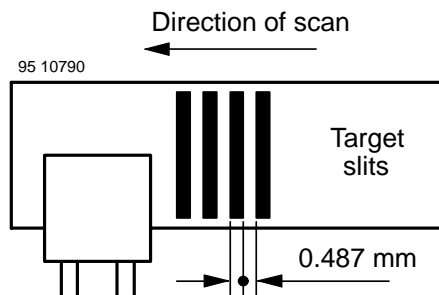

Figure 1. Test circuit for phase angle measurement

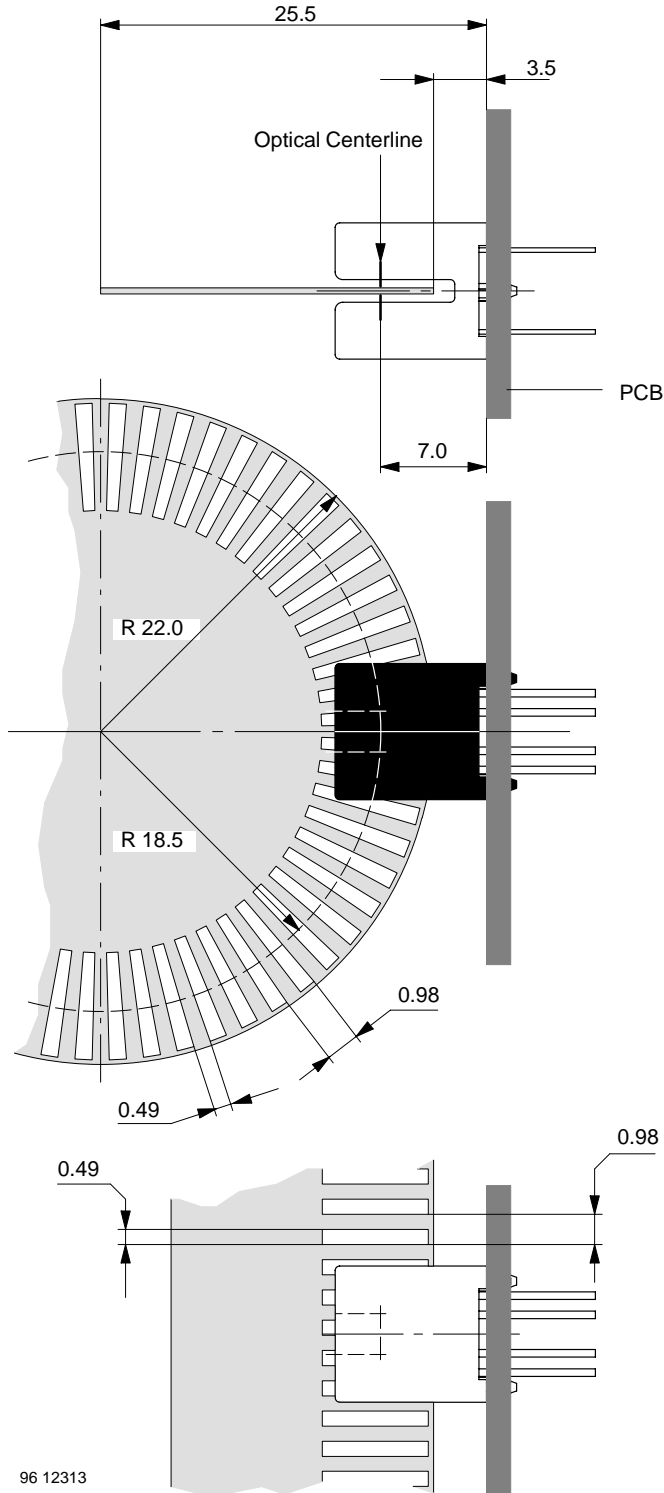
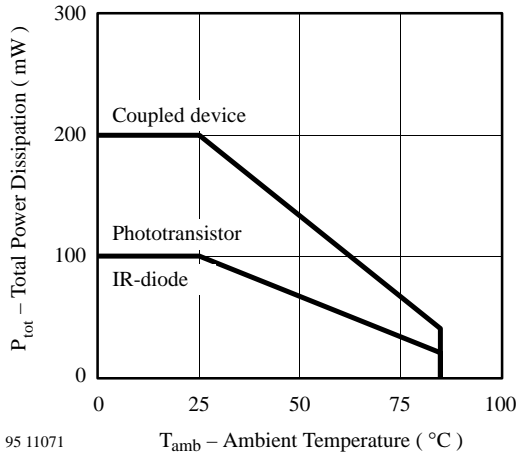

Figure 2.

Typical Characteristics ($T_{amb} = 25^{\circ}\text{C}$, unless otherwise specified)



95 11071

Figure 3. Total Power Dissipation vs. Ambient Temperature

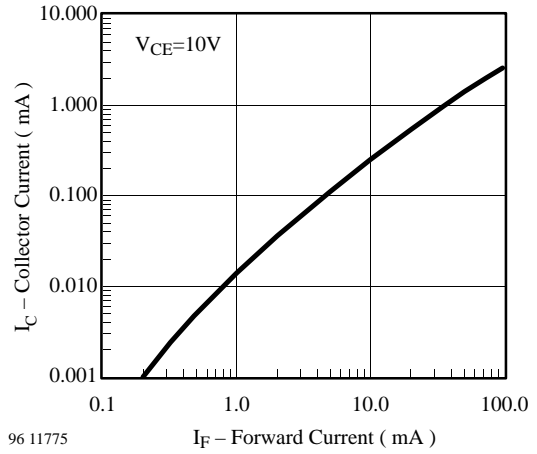

96 11775

Figure 6. Collector Current vs. Forward Current

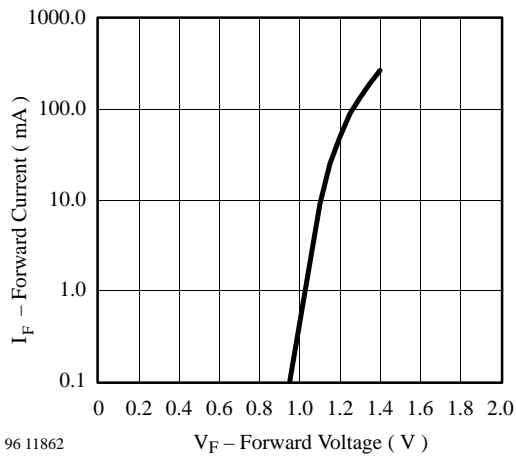

96 11862

Figure 4. Forward Current vs. Forward Voltage

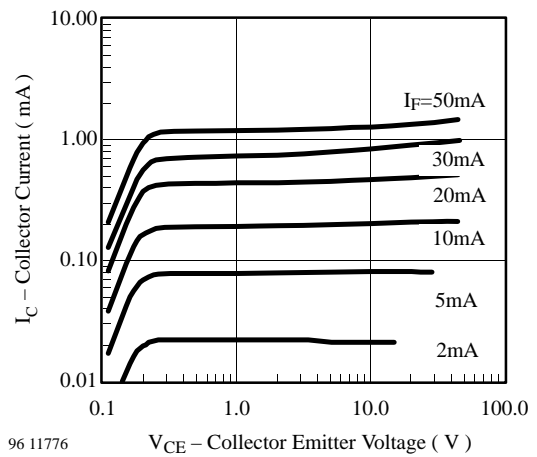

96 11776

Figure 7. Collector Current vs. Collector Emitter Voltage

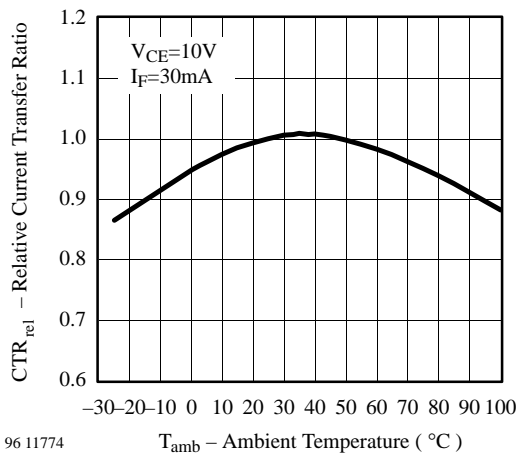

96 11774

Figure 5. Relative Current Transfer Ratio vs. Ambient Temperature

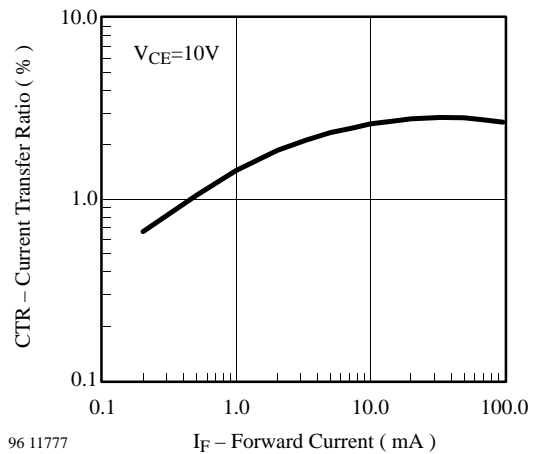

96 11777

Figure 8. Current Transfer Ratio vs. Forward Current

TCVT1300

Vishay Telefunken



Dimensions of TCVT1300 in mm

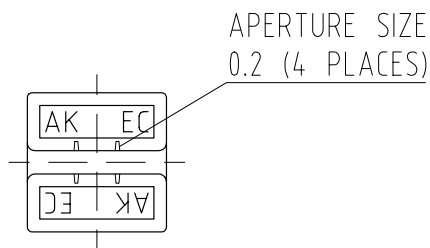
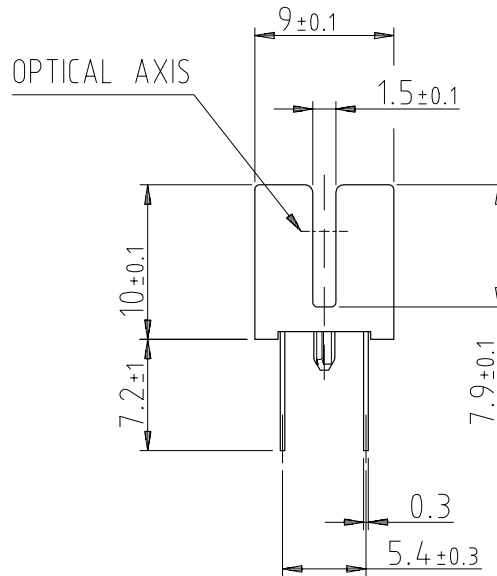
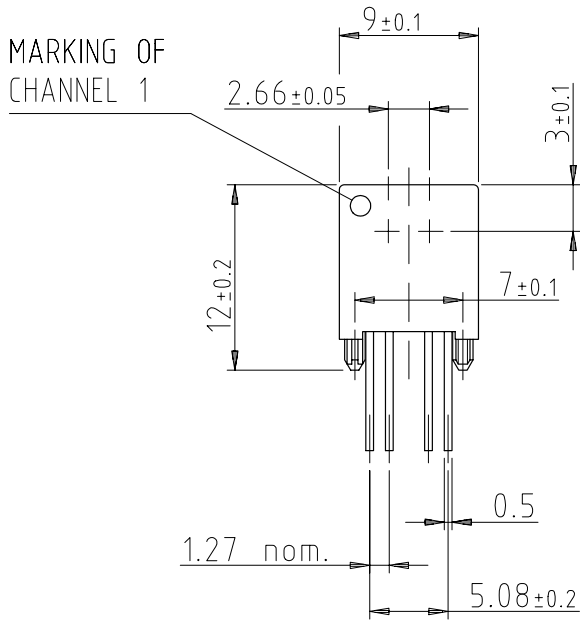

weight: ca. 0.78g

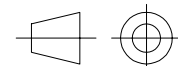

technical drawings according to DIN specifications
9 6 12082



Ozone Depleting Substances Policy Statement

It is the policy of **Vishay Semiconductor GmbH** to

1. Meet all present and future national and international statutory requirements.
2. Regularly and continuously improve the performance of our products, processes, distribution and operating systems with respect to their impact on the health and safety of our employees and the public, as well as their impact on the environment.

It is particular concern to control or eliminate releases of those substances into the atmosphere which are known as ozone depleting substances (ODSs).

The Montreal Protocol (1987) and its London Amendments (1990) intend to severely restrict the use of ODSs and forbid their use within the next ten years. Various national and international initiatives are pressing for an earlier ban on these substances.

Vishay Semiconductor GmbH has been able to use its policy of continuous improvements to eliminate the use of ODSs listed in the following documents.

1. Annex A, B and list of transitional substances of the Montreal Protocol and the London Amendments respectively
2. Class I and II ozone depleting substances in the Clean Air Act Amendments of 1990 by the Environmental Protection Agency (EPA) in the USA
3. Council Decision 88/540/EEC and 91/690/EEC Annex A, B and C (transitional substances) respectively.

Vishay Semiconductor GmbH can certify that our semiconductors are not manufactured with ozone depleting substances and do not contain such substances.

We reserve the right to make changes to improve technical design and may do so without further notice. Parameters can vary in different applications. All operating parameters must be validated for each customer application by the customer. Should the buyer use Vishay Telefunken products for any unintended or unauthorized application, the buyer shall indemnify Vishay Telefunken against all claims, costs, damages, and expenses, arising out of, directly or indirectly, any claim of personal damage, injury or death associated with such unintended or unauthorized use.

Vishay Semiconductor GmbH, P.O.B. 3535, D-74025 Heilbronn, Germany
Telephone: 49 (0) 7131 67 2831, Fax number: 49 (0) 7131 67 2423