

TOSHIBA

TD62003,004FB

TOSHIBA BIPOLAR DIGITAL INTEGRATED CIRCUIT SILICON MONOLITHIC

TD62003FB, TD62004FB

7CH DARLINGTON SINK DRIVER

The TD62003FB series are high-voltage, high-current darlington drivers comprised of seven NPN darlington pairs.

All units feature integral clamp diodes for switching inductive loads.

Applications include relay, hammer, lamp and display (LED) drivers.

FEATURES

- Output current (single output) : 500mA / ch (Max.)
- High sustaining voltage output : 35V (Min.)
- Output clamp diodes
- Inputs compatible with various types of logic.
TD62003FB : $R_{IN} = 2.7k\Omega$
TD62004FB : $R_{IN} = 10.5k\Omega$
- Package SOP-16 pin

PIN CONNECTION (TOP VIEW)

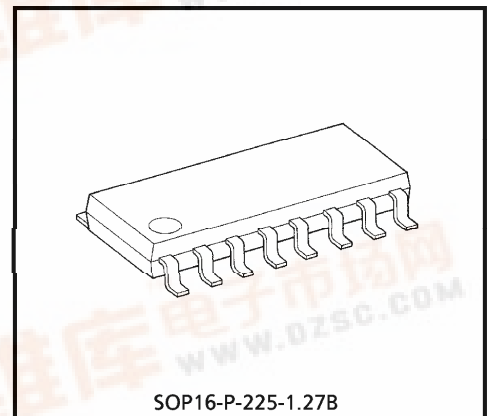
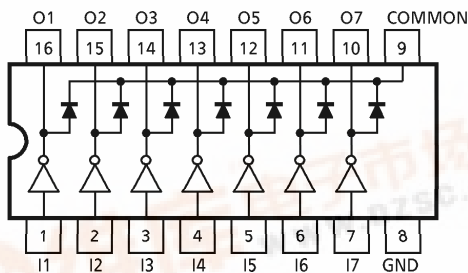

SOP16-P-225-1.27B

Weight : 0.16g (Typ.)

SCHEMATICS (EACH DRIVER)

TD62003FB

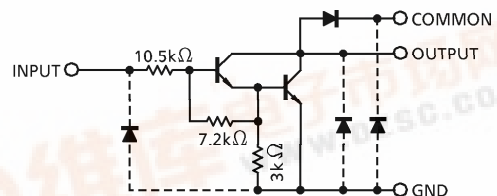
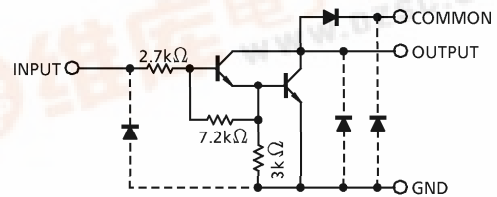

(Note) The input and output parasitic diodes cannot be used as clamp diodes.

961001EBA2

- TOSHIBA is continually working to improve the quality and the reliability of its products. Nevertheless, semiconductor devices in general can malfunction or fail due to their inherent electrical sensitivity and vulnerability to physical stress. It is the responsibility of the buyer, when utilizing TOSHIBA products, to observe standards of safety, and to avoid situations in which a malfunction or failure of a TOSHIBA product could cause loss of human life, bodily injury or damage to property. In developing your designs, please ensure that TOSHIBA products are used within specified operating ranges as set forth in the most recent products specifications. Also, please keep in mind the precautions and conditions set forth in the TOSHIBA Semiconductor Reliability Handbook.
- The products described in this document are subject to foreign exchange and foreign trade control laws.
- The information contained herein is presented only as a guide for the applications of our products. No responsibility is assumed by TOSHIBA CORPORATION for any infringements of intellectual property or other rights of the third parties which may result from its use. No license is granted by implication or otherwise under any intellectual property or other rights of TOSHIBA CORPORATION or others.
- The information contained herein is subject to change without notice.

MAXIMUM RATINGS (Ta = 25°C)

CHARACTERISTIC	SYMBOL	RATING	UNIT
Output Sustaining Voltage	V _{CE(SUS)}	- 0.5~35	V
Output Current	I _{OUT}	500	mA / ch
Input Voltage	V _{IN}	- 0.5~30	V
Clamp Diode Reverse Voltage	V _R	35	V
Clamp Diode Forward Current	I _F	500	mA
Power Dissipation	P _D	0.54 / 0.625 (Note)	W
Operating Temperature	T _{opr}	- 40~85	°C
Storage Temperature	T _{stg}	- 55~150	°C

(Note) On Glass Epoxy PCB (30×30×1.6mm Cu 50%)

RECOMMENDED OPERATING CONDITIONS (Ta = - 40~85°C)

CHARACTERISTIC	SYMBOL	CONDITION	MIN.	TYP.	MAX.	UNIT	
Output Sustaining Voltage	V _{CE(SUS)}	—	0	—	35	V	
Output Current	I _{OUT}	DC 1 Circuit	0	—	350	mA / ch	
		T _{pw} = 25ms T _j = 120°C 7 Circuits	Duty = 10%	0	—		275
		Ta = 85°C	Duty = 50%	0	—		90
Input Voltage	V _{IN}	—	0	—	24	V	
Input Voltage (Output On)	TD62003	V _{IN(ON)}	I _{OUT} = 400mA, h _{FE} = 800	2.8	—	24	V
	TD62004			6.2	—	24	
Input Voltage (Output Off)	TD62003	V _{IN(OFF)}	—	0	—	0.7	V
	TD62004			0	—	1.0	
Clamp Diode Reverse Voltage	V _R	—	—	—	35	V	
Clamp Diode Forward Current	I _F	—	—	—	350	mA	
Power Dissipation	P _D	(Note) Ta = 85°C	—	—	0.325	W	

(Note) On Glass Epoxy PCB (30×30×1.6mm Cu 50%)

ELECTRICAL CHARACTERISTICS (Ta = 25°C)

CHARACTERISTIC	SYMBOL	TEST CIRCUIT	TEST CONDITION	MIN.	TYP.	MAX.	UNIT	
Output Leakage Current	I _{CEX}	1	V _{CE} = 35V, Ta = 25°C	—	—	50	μA	
			V _{CE} = 35V, Ta = 85°C	—	—	100		
Collector-Emitter Saturation Voltage	V _{CE (sat)}	2	I _{OUT} = 350mA, I _{IN} = 500μA	—	1.3	1.6	V	
			I _{OUT} = 200mA, I _{IN} = 350μA	—	1.1	1.3		
			I _{OUT} = 100mA, I _{IN} = 250μA	—	0.9	1.1		
DC Current Transfer Ratio	h _{FE}	2	V _{CE} = 2V, I _{OUT} = 350mA	1000	—	—		
Input Current (Output On)	TD62003	3	V _{IN} = 2.4V, I _{OUT} = 350mA	—	0.4	0.7	mA	
	TD62004		V _{IN} = 9.5V, I _{OUT} = 350mA	—	0.8	1.2		
Input Current (Output Off)	I _{IN (OFF)}	4	I _{OUT} = 500μA, Ta = 85°C	50	65	—	μA	
Input Voltage (Output On)	V _{IN (ON)}	5	V _{CE} = 2V h _{FE} = 800	I _{OUT} = 350mA	—	—	2.6	V
				I _{OUT} = 200mA	—	—	2.0	
				I _{OUT} = 350mA	—	—	4.7	
				I _{OUT} = 200mA	—	—	4.4	
Clamp Diode Reverse Current	I _R	6	V _R = 35V, Ta = 25°C	—	—	50	μA	
			V _R = 35V, Ta = 85°C	—	—	100		
Clamp Diode Forward Voltage	V _F	7	I _F = 350mA	—	—	2.0	V	
Input Capacitance	C _{IN}	8	—	—	15	—	pF	
Turn-On Delay	t _{ON}	9	V _{OUT} = 35V, R _L = 87.5Ω C _L = 15pF	—	0.1	—	μs	
Turn-Off Delay	t _{OFF}	9	V _{OUT} = 35V, R _L = 87.5Ω C _L = 15pF	—	0.2	—		

TEST CIRCUIT

1. I_{CEX}

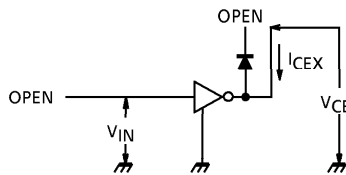

2. V_{CE (sat)}, h_{FE}

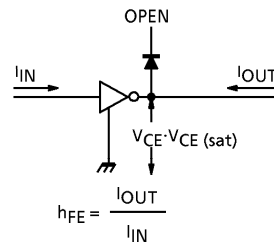

3. I_{IN (ON)}

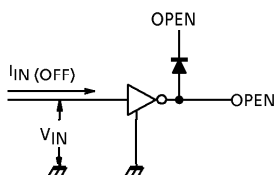

4. I_{IN (OFF)}

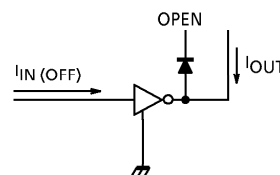

5. $V_{IN(ON)}$

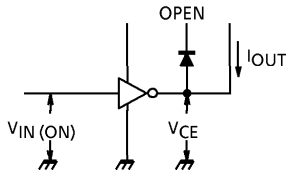

6. I_R

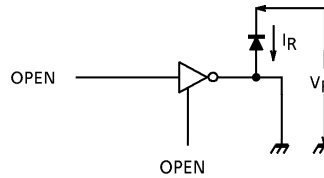

7. V_F

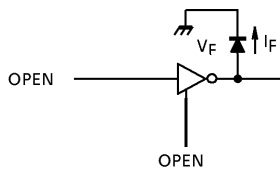

8. t_{ON}, t_{OFF}

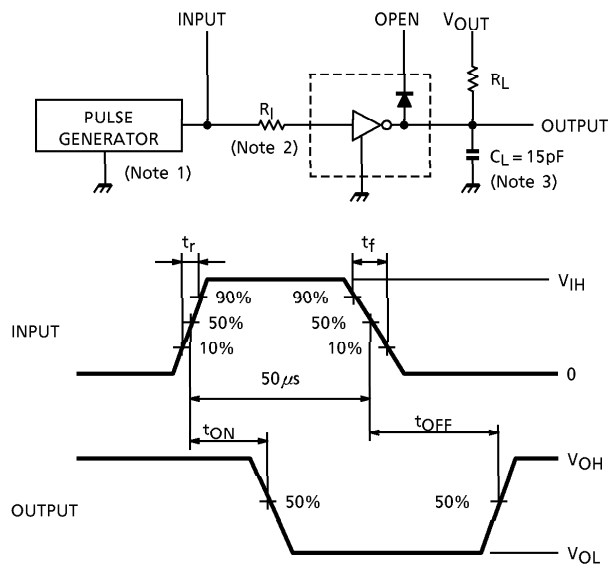

(Note 1) Pulse Width $50\mu s$, Duty Cycle 10%
Output Impedance 50Ω , $t_r \leq 5ns$, $t_f \leq 10ns$

(Note 2) See below.

INPUT CONDITION

TYPE NUMBER	R_I	V_{IH}
TD620003FB	0	3V
TD620004FB	0	8V

(Note 3) C_L includes probe and jig capacitance.

PRECAUTIONS for USING

Utmost care is necessary in the design of the output line, COMMON and GND line since IC may be destroyed due to short-circuit between outputs, air contamination fault, or fault by improper grounding.

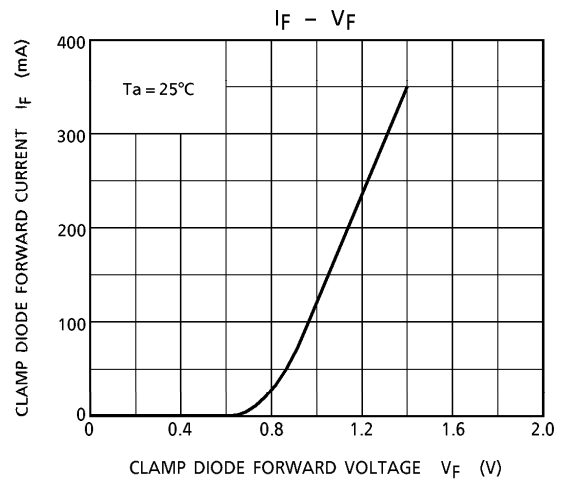
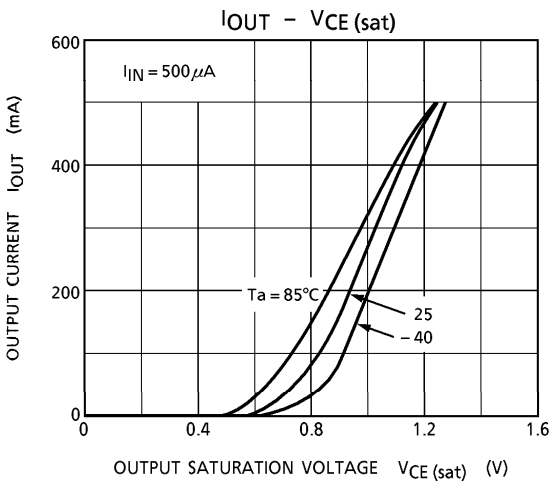
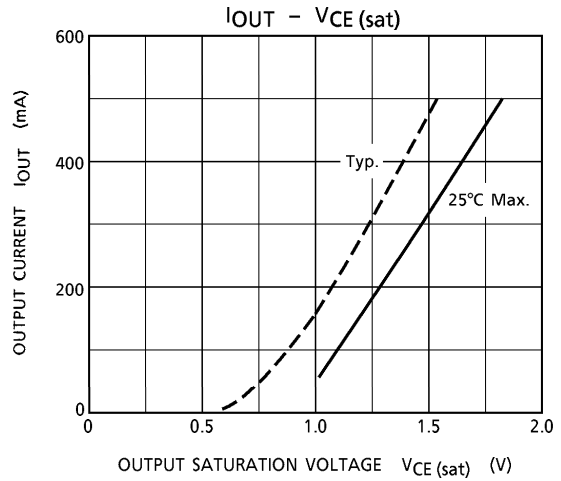
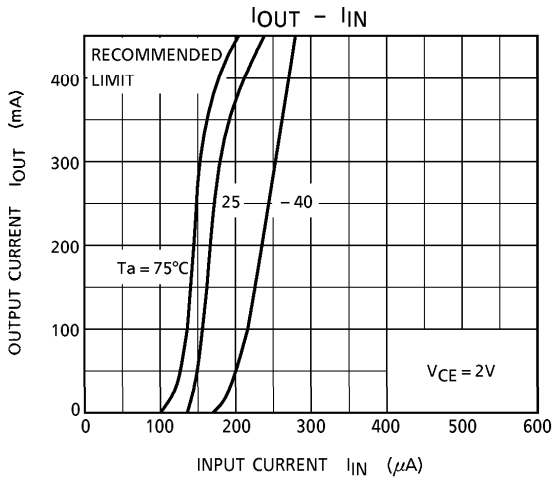
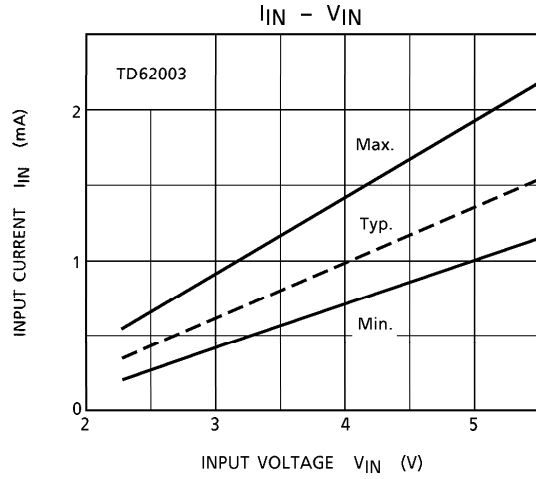
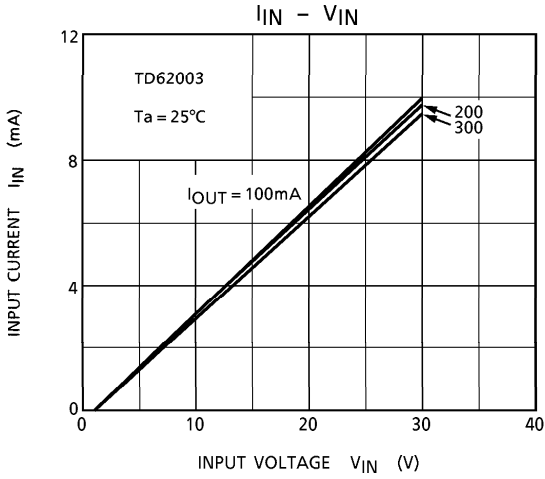

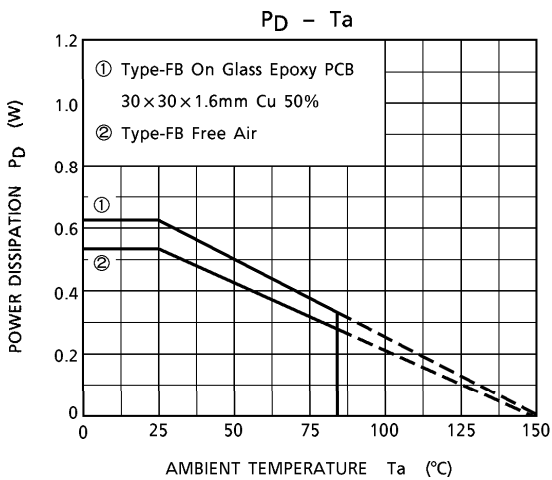
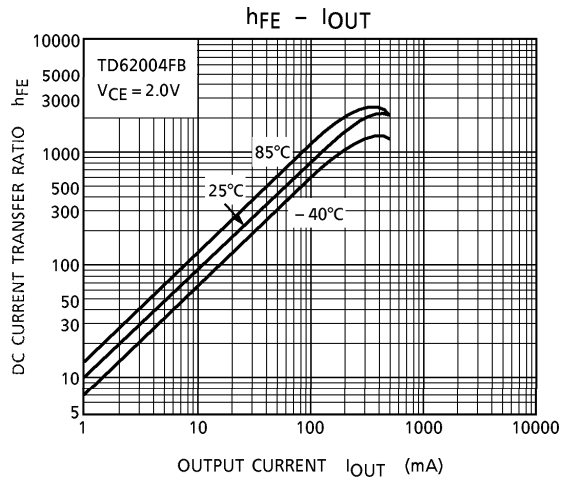
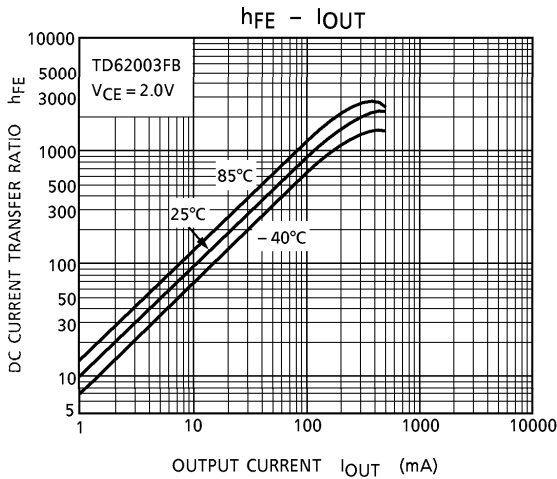
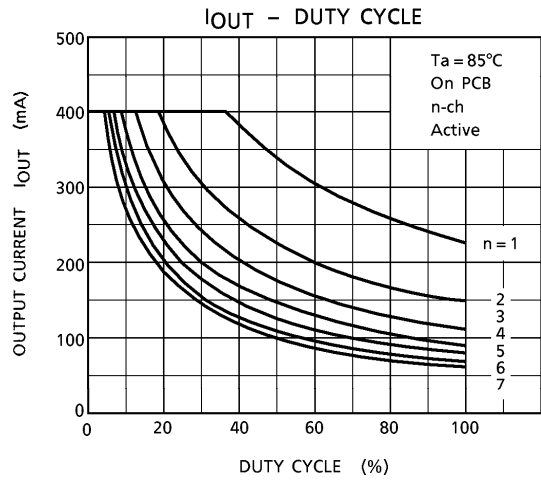
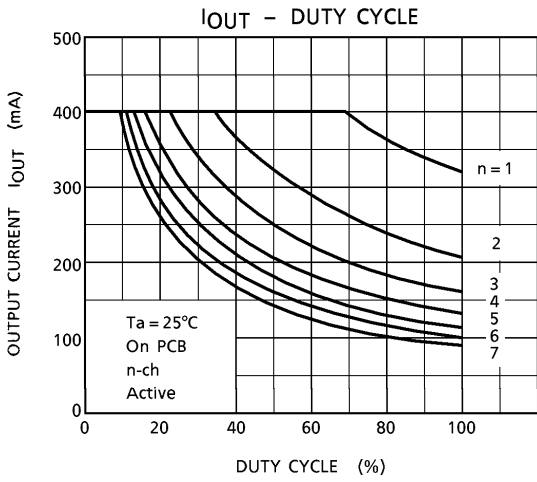

OUTLINE DRAWING
SOP16-P-225-1.27B

Unit : mm

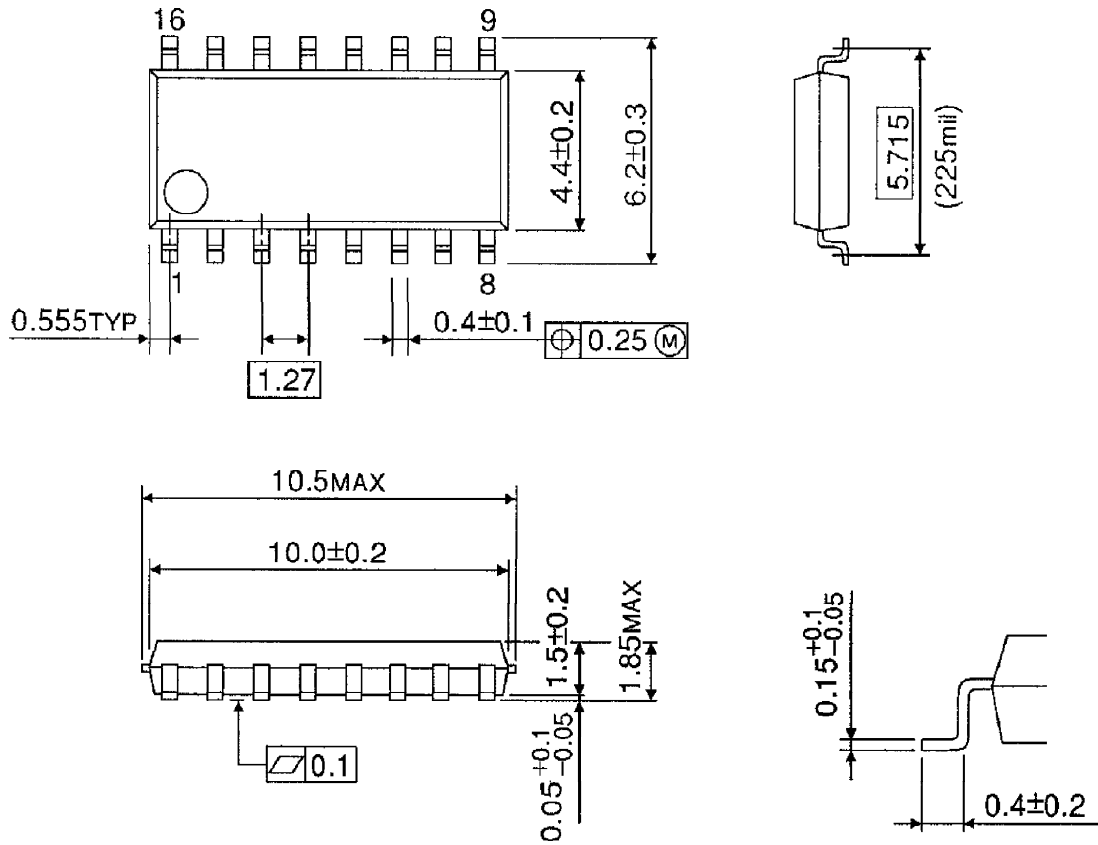

Weight : 0.16g (Typ.)