

TOSHIBA BIPOLAR DIGITAL INTEGRATED CIRCUIT SILICON MONOLITHIC

TD62309P, TD62309F

6CH LOW SATURATION HIGH-CURRENT SINK DRIVER

The TD62309P, TD62309F are comprised of six NPN low saturation drivers.

All units feature integral clamp diodes for switching inductive loads. These devices are specifically designed for relay, lamp and LED drive in low voltage systems.

FEATURES

- Low saturation output : $V_{CE(sat)} = 0.8V$ (Max.)
@ $I_{OUT} = 450mA$
- Output rating (single output) 20V (Min.)/700mA (Max.)
Output clamp diodes
- Inputs compatible with TTL and 3~6V CMOS
- Package type-P : DIP-16pin
- Package type-F : PFP-16pin

PIN CONNECTION (TOP VIEW)

TD62309P

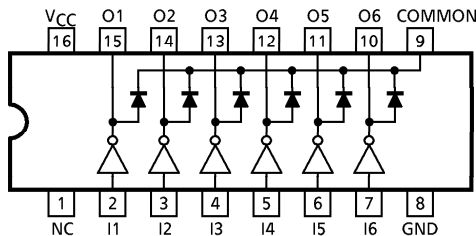

TD62309F

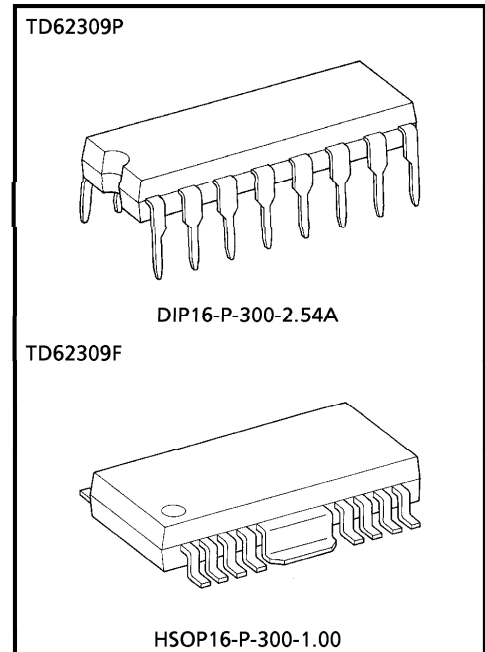
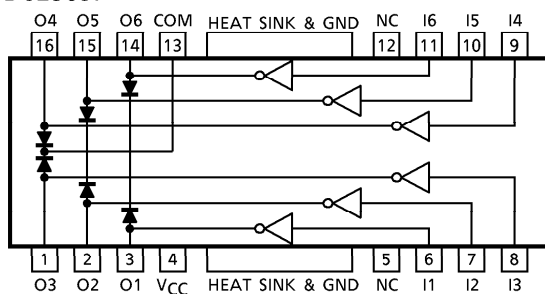

Weight
 DIP16-P-300-2.54A : 1.11g (Typ.)
 HSOP16-P-300-1.00 : 0.50g (Typ.)

SCHEMATICS (EACH DRIVER)

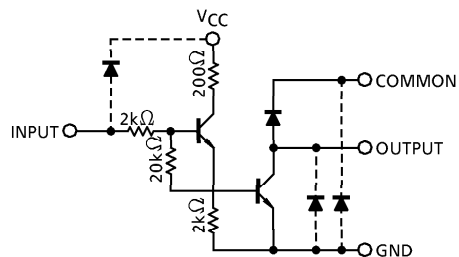

(Note) The input and output parasitic diodes cannot be used as clamp diodes.

961001EBA2

- TOSHIBA is continually working to improve the quality and the reliability of its products. Nevertheless, semiconductor devices in general can malfunction or fail due to their inherent electrical sensitivity and vulnerability to physical stress. It is the responsibility of the buyer, when utilizing TOSHIBA products, to observe standards of safety, and to avoid situations in which a malfunction or failure of a TOSHIBA product could cause loss of human life, bodily injury or damage to property. In developing your designs, please ensure that TOSHIBA products are used within specified operating ranges as set forth in the most recent products specifications. Also, please keep in mind the precautions and conditions set forth in the TOSHIBA Semiconductor Reliability Handbook.
- The products described in this document are subject to foreign exchange and foreign trade control laws.
- The information contained herein is presented only as a guide for the applications of our products. No responsibility is assumed by TOSHIBA CORPORATION for any infringements of intellectual property or other rights of the third parties which may result from its use. No license is granted by implication or otherwise under any intellectual property or other rights of TOSHIBA CORPORATION or others.
- The information contained herein is subject to change without notice.

MAXIMUM RATINGS (Ta = 25°C)

CHARACTERISTIC	SYMBOL	RATING	UNIT
Supply Voltage	V _{CC}	10	V
Output Sustaining Voltage	V _{CE(SUS)}	20	V
Output Current	I _{OUT}	700	mA / ch
Input Voltage	V _{IN}	10	V
Input Current	I _{IN}	10	mA
Clamp Diode Reverse Voltage	V _R	20	V
Clamp Diode Forward Current	I _F	700	mA
Power Dissipation	P	1.47	W
	F	1.4 (Note)	
Operating Temperature	T _{opr}	-40~85	°C
Storage Temperature	T _{stg}	-55~150	°C

(Note) On Glass Epoxy PCB (60×30×1.6mm Cu 30%)

RECOMMENDED OPERATING CONDITIONS (Ta = -40~85°C)

CHARACTERISTIC	SYMBOL	CONDITION	MIN.	TYP.	MAX.	UNIT
Supply Voltage	V _{CC}	—	3	5	7	V
Output Sustaining Voltage	V _{CE(SUS)}	—	—	—	20	V
Output Current	I _{OUT}	DC 1 circuit	0	—	700	mA
		T _{pw} = 25ms, 6 circuits	0	—	200	
Input Voltage	V _{IN}	—	0	—	V _{CC}	V
Clamp Diode Reverse Voltage	V _R	—	—	—	20	V
Clamp Diode Forward Current	I _F	—	—	—	700	mA
Power Dissipation	P	—	—	—	0.52	W
	F	(Note)	—	—	0.5	

(Note) On Glass Epoxy PCB (60×30×1.6mm Cu 30%)

ELECTRICAL CHARACTERISTICS (Ta = 25°C)

CHARACTERISTIC	SYMBOL	TEST CIR-CUIT	TEST CONDITION	MIN.	TYP.	MAX.	UNIT
Output Leakage Current	I_{CEX}	1	$V_{OUT} = 20V, T_a = 85^\circ C$	—	—	100	μA
Output Saturation Voltage	$V_{CE(sat)}$	2	$V_{CC} = 5V, I_{OUT} = 450mA$	—	—	0.8	V
			$V_{CC} = 5V, I_{OUT} = 200mA$	—	—	0.45	
Input Current (Output On)	$I_{IN(ON)}$	3	$V_{IN} = 3.2V$	—	0.84	1.4	mA
D.C Forward Current Transfer Ratio	h_{FE}	2	$V_{CE} = 4V, V_{CC} = 6V$ $I_{OUT} = 300mA$	3000	—	—	
Supply Current	Output On	6	$V_{CC} = 7V, V_{IN} = 3.2V$ 6 circuits	—	120	300	mA
	Output Off			$I_{CC(OFF)}$	6	$V_{CC} = 7V$	—
Clamp Diode Reverse Current	I_R	4	$V_R = 20V$	—	—	100	μA
Clamp Diode Forward Voltage	V_F	5	$I_F = 350mA$	—	—	2.7	V
Turn-On Delay	t_{ON}	7	$V_{CC} = 5.0V, R_L = 36\Omega$ $C_L = 15pF, V_{OUT} = 20V$	—	0.1	—	μs
Turn-Off Delay	t_{OFF}			—	0.2	—	

TEST CIRCUIT

1. I_{CEX}

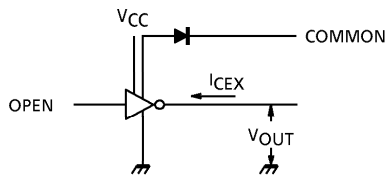

2. $h_{FE}, V_{CE(sat)}$

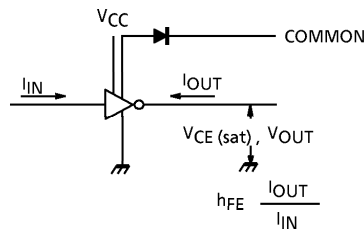

3. $I_{IN(ON)}$

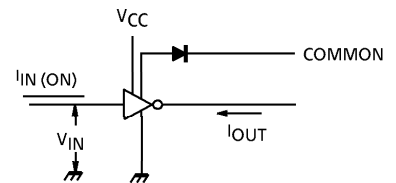

4. I_R

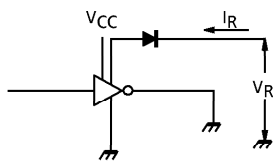

5. V_F

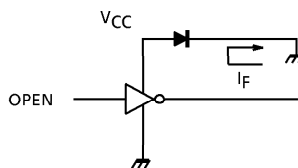

6. $I_{CC(ON)}, I_{CC(OFF)}$

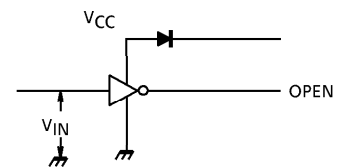

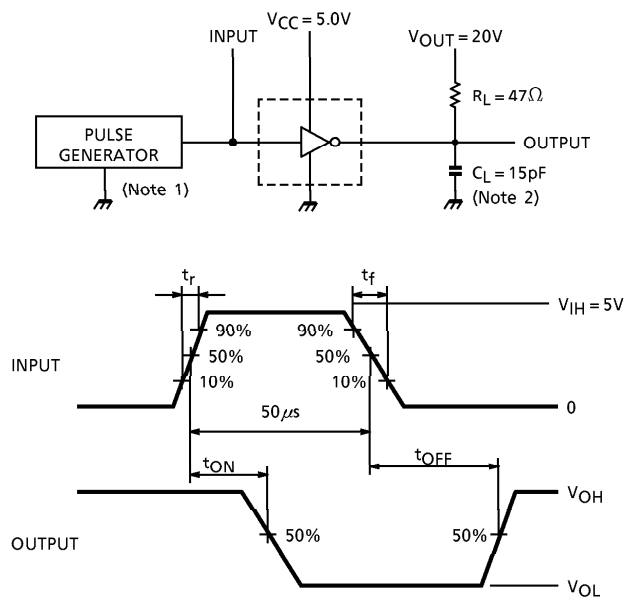
7. t_{ON} , t_{OFF} 

- (Note 1) Pulse width $50\mu s$, duty cycle 10%
 Output impedance 50Ω , $t_r \leq 5ns$, $t_f \leq 10ns$
 (Note 2) C_L includes probe and jig capacitance.

PRECAUTIONS for USING

Utmost care is necessary in the design of the output line, V_{CC} , COMMON and GND line since IC may be destroyed due to short-circuit between outputs, air contamination fault, or fault by improper grounding.

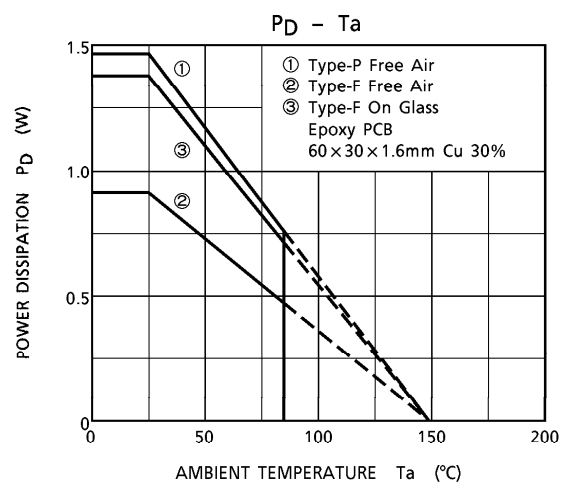
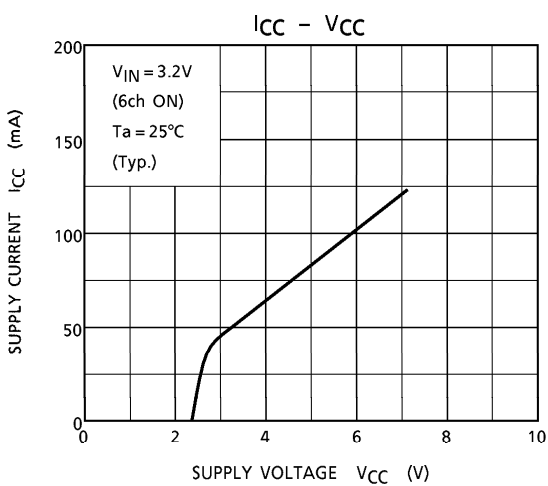
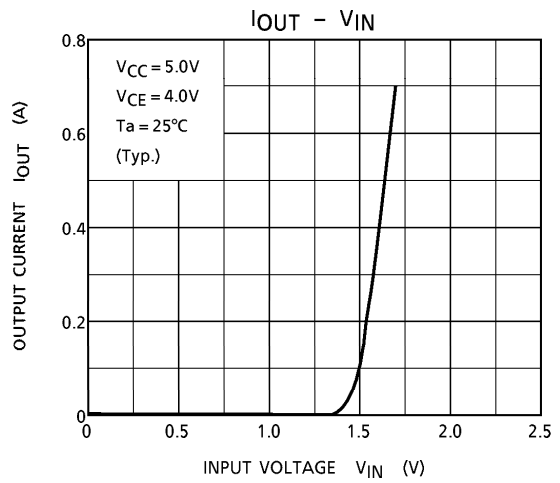
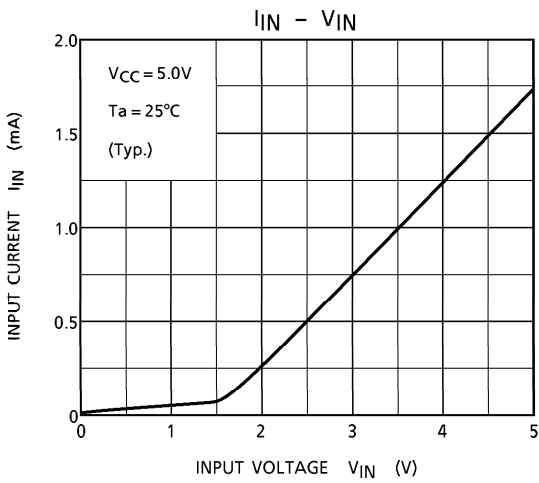
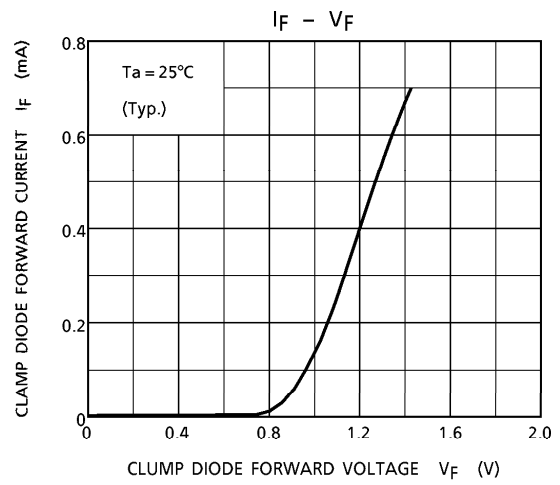
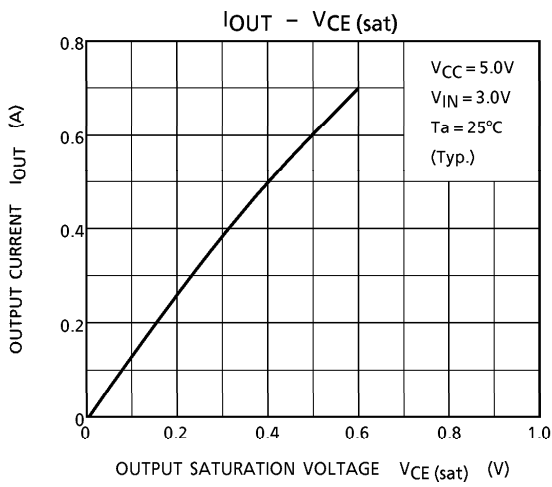

OUTLINE DRAWING
DIP16-P-300-2.54A

Unit : mm

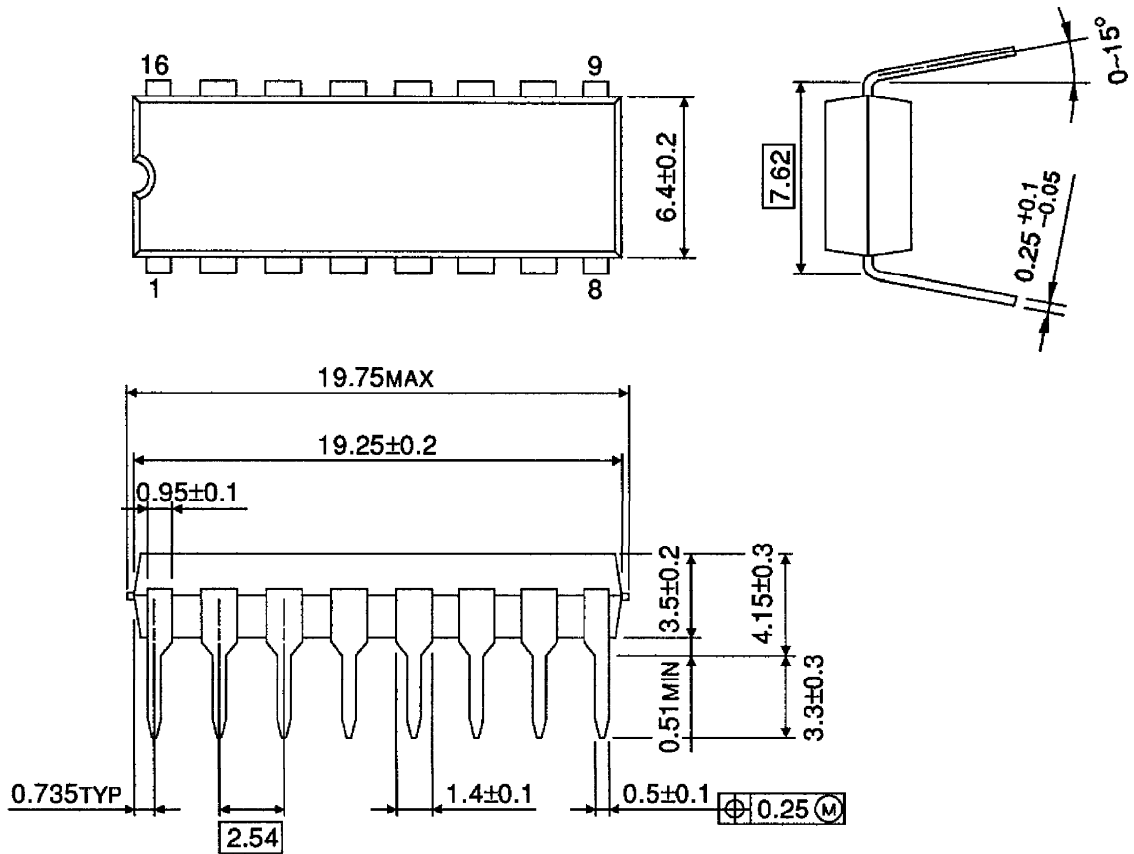

Weight : 1.11g (Typ.)

OUTLINE DRAWING
HSOP16-P-300-1.00

Unit : mm

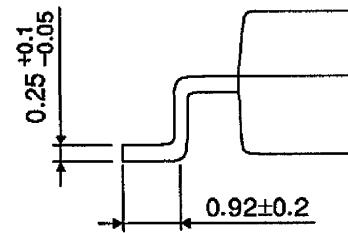
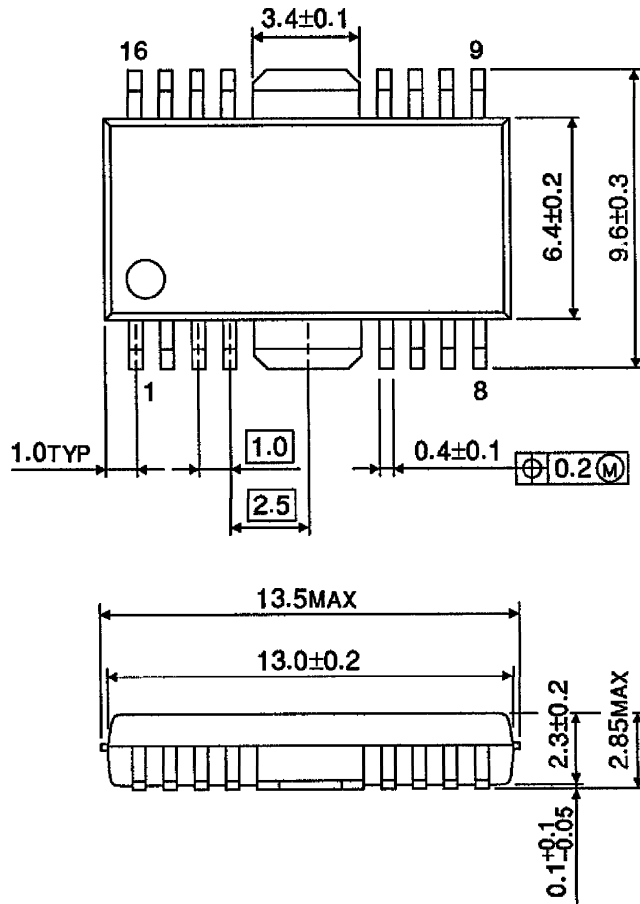

Weight : 0.50g (Typ.)

Copyright Each Manufacturing Company.

All Datasheets cannot be modified without permission.

This datasheet has been download from :

www.AllDataSheet.com

100% Free DataSheet Search Site.

Free Download.

No Register.

Fast Search System.

www.AllDataSheet.com