

TOSHIBA BIPOLAR DIGITAL INTEGRATED CIRCUIT SILICON MONOLITHIC

# TD62318AP, TD62318AF

## 4CH LOW INPUT ACTIVE HIGH-CURRENT DARLINGTON SINK DRIVER

The TD62318AP, TD62318AF are non-inverting transistor array which are comprised of four NPN darlington output stages and PNP input stages.

These devices are low level input active driver and are suitable for operation with TTL, 5V CMOS and 5V Microprocessor which have sink current output drivers. Applications include relay, hammer, lamp and stepping moter drivers.

### FEATURES

- Output current (single output) 700mA (Max.)
- High sustaining voltage output 50V (Min.)
- Output clamp diodes
- Input compatible with TTL and 5V CMOS
- Low level active inputs
- Standard supply voltage
- Two V<sub>CC</sub> terminals V<sub>CC1</sub>, V<sub>CC2</sub> (separated)
- GND and SUB terminal = heat sink
- Package type-AP : DIP-16pin
- Package type-AF : PFP-16pin

### PIN CONNECTION (TOP VIEW)

TD62318AP

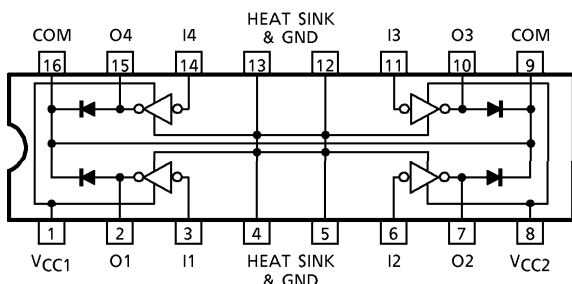

TD62318AF

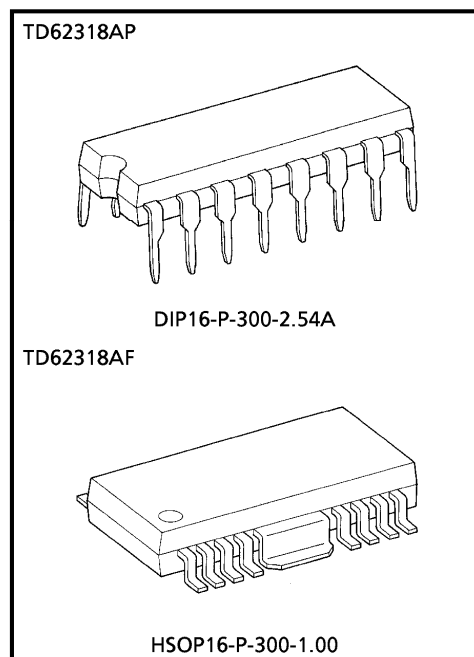
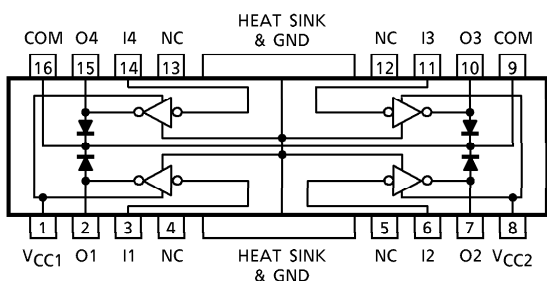

Weight  
 DIP16-P-300-2.54A : 1.11g (Typ.)  
 HSOP16-P-300-1.00 : 0.50g (Typ.)

### SCHEMATICS (EACH DRIVER)

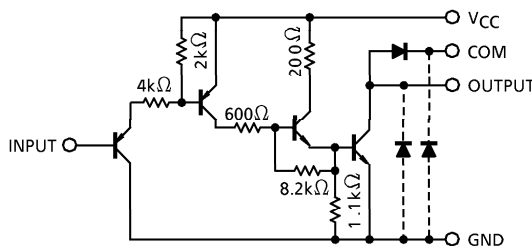

(Note) The input and output parasitic diodes cannot be used as clamp diodes.

961001EBA2

● TOSHIBA is continually working to improve the quality and the reliability of its products. Nevertheless, semiconductor devices in general can malfunction or fail due to their inherent electrical sensitivity and vulnerability to physical stress. It is the responsibility of the buyer, when utilizing TOSHIBA products, to observe standards of safety, and to avoid situations in which a malfunction or failure of a TOSHIBA product could cause loss of human life, bodily injury or damage to property. In developing your designs, please ensure that TOSHIBA products are used within specified operating ranges as set forth in the most recent products specifications. Also, please keep in mind the precautions and conditions set forth in the TOSHIBA Semiconductor Reliability Handbook.

**MAXIMUM RATINGS (Ta = 25°C)**

CHARACTERISTIC	SYMBOL	RATING	UNIT
Supply Voltage	V <sub>CC</sub>	-0.5~17	V
Output Sustaining Voltage	V <sub>CE(SUS)</sub>	-0.5~50	V
Output Current	I <sub>OUT</sub>	700	mA / ch
Input Current	I <sub>IN</sub>	-10	mA
Input Voltage	V <sub>IN</sub>	-0.5~30	V
Clamp Diode Reverse Voltage	V <sub>R</sub>	50	V
Clamp Diode Forward Current	I <sub>F</sub>	700	mA
Power Dissipation	AP	P <sub>D</sub>	W
	AF		
		1.47 / 2.7 (Note 1)	
		0.9 / 1.4 (Note 2)	
Operating Temperature	T <sub>opr</sub>	-40~85	°C
Storage Temperature	T <sub>stg</sub>	-55~150	°C

(Note 1) On Glass Epoxy (50×50×1.6mm Cu 50%)

(Note 2) On Glass Epoxy (60×30×1.6mm Cu 30%)

**RECOMMENDED OPERATING CONDITIONS (Ta = -40~85°C)**

CHARACTERISTIC	SYMBOL	CONDITION	MIN.	TYP.	MAX.	UNIT	
Supply Voltage	V <sub>CC</sub>		4.5	—	5.5	V	
Output Sustaining Voltage	V <sub>CE(SUS)</sub>		0	—	50	V	
Output Current	I <sub>OUT</sub>	DC 1 circuit, Ta = 25°C	0	—	570	mA / ch	
		T <sub>pw</sub> = 25ms 4 circuits	Duty = 10%	0	—		570
			Duty = 50%	0	—		570
		Ta = 85°C T <sub>j</sub> = 120°C	Duty = 10%	0	—		570
			Duty = 50%	0	—		480
Input Voltage	V <sub>IN</sub>		0	—	15	V	
Input Voltage	Output On	V <sub>IN(ON)</sub>	0	—	V <sub>CC</sub> -3.6	V	
	Output Off	V <sub>IN(OFF)</sub>	V <sub>CC</sub> -1.6	—	5.5		
Clamp Diode Reverse Voltage	V <sub>R</sub>		—	—	50	V	
Clamp Diode Forward Current	I <sub>F</sub>		—	—	500	mA	
Power Dissipation	AP	P <sub>D</sub>	—	—	1.4	W	
	AF						
		Ta = 85°C (Note 1)					
		Ta = 85°C (Note 2)			0.7		

(Note 1) On Glass Epoxy (50×50×1.6mm Cu 50%)

(Note 2) On Glass Epoxy (60×30×1.6mm Cu 30%)

961001EBA2'

- The products described in this document are subject to foreign exchange and foreign trade control laws.
- The information contained herein is presented only as a guide for the applications of our products. No responsibility is assumed by TOSHIBA CORPORATION for any infringements of intellectual property or other rights of the third parties which may result from its use. No license is granted by implication or otherwise under any intellectual property or other rights of TOSHIBA CORPORATION or others.
- The information contained herein is subject to change without notice.

**ELECTRICAL CHARACTERISTICS (Ta = 25°C)**

CHARACTERISTIC		SYMBOL	TEST CIR-CUIT	TEST CONDITION	MIN.	TYP.	MAX.	UNIT
Input Voltage	"H" Level	$V_{IH}$	—		$V_{CC} - 1.6$	—	25	V
	"L" Level	$V_{IL}$			0	—	$V_{CC} - 3.6$	
Input Current	"H" Level	$I_{IH}$	2		—	—	10	$\mu A$
	"L" Level	$I_{IL}$			—	-0.05	-0.36	mA
Output Leakage Current		$I_{CEX}$	1	$V_{CE} = 50V, Ta = 25^{\circ}C$	—	—	50	$\mu A$
				$V_{CE} = 50V, Ta = 85^{\circ}C$	—	—	100	
Output Saturation Voltage		$V_{CE(sat)}$	3	$I_{OUT} = 0.5A, V_{CC} = 4.5V$	—	—	0.8	V
					$I_{OUT} = 0.2A, V_{CC} = 4.5V$	—	—	
Clamp Diode Reverse Current		$I_R$	4	$V_R = 50V, Ta = 25^{\circ}C$	—	—	50	$\mu A$
					$V_R = 50V, Ta = 85^{\circ}C$	—	—	
Clamp Diode Forward Voltage		$V_F$	5	$I_F = 500mA$	—	—	2.0	V
Supply Current	Output On	$I_{CC(ON)}$	2	$V_{CC} = 5.5V, V_{IN} = 0V$	—	35	40	mA / ch
	Output Off	$I_{CC(OFF)}$	2	$V_{CC} = 5.5V, V_{IN} = V_{CC}$	—	—	10	$\mu A$
Turn-On Delay		$t_{ON}$	6	$V_{OUT} = 50V, R_L = 90\Omega$ $V_{CC} = 5.0V, C_L = 15pF$	—	0.4	0.8	$\mu s$
Turn-Off Delay		$t_{OFF}$			—	8.0	16.0	

**TEST CIRCUIT**

1.  $I_{CEX}$

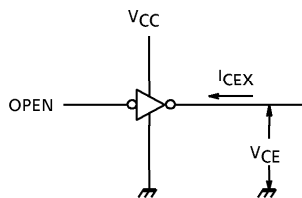

2.  $I_{IH}, I_{IL}$

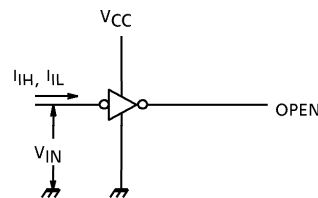

3.  $V_{CE(sat)}$

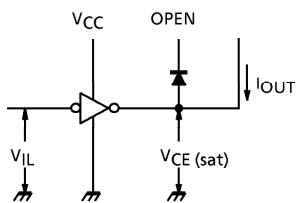

4.  $I_R$

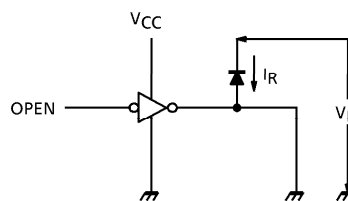

5.  $V_F$

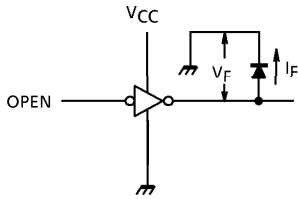

6.  $t_{ON}$ ,  $t_{OFF}$

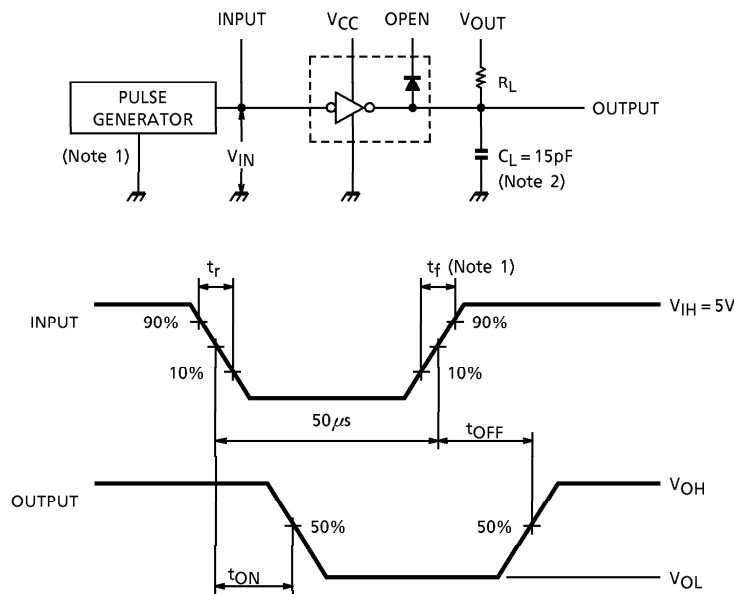

- (Note 1) Pulse width  $50\mu s$ , duty cycle 10%  
Output impedance  $50\Omega$   $t_r \leq 5ns$ ,  $t_f \leq 10ns$
- (Note 2)  $C_L$  includes probe and jig capacitance.

**PRECAUTIONS for USING**

Utmost care is necessary in the design of the output line,  $V_{CC}$ , COMMON and GND line since IC may be destroyed due to short-circuit between outputs, air contamination fault, or fault by improper grounding.

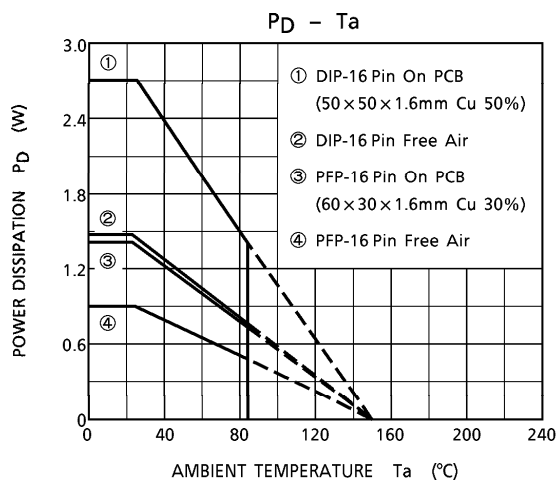
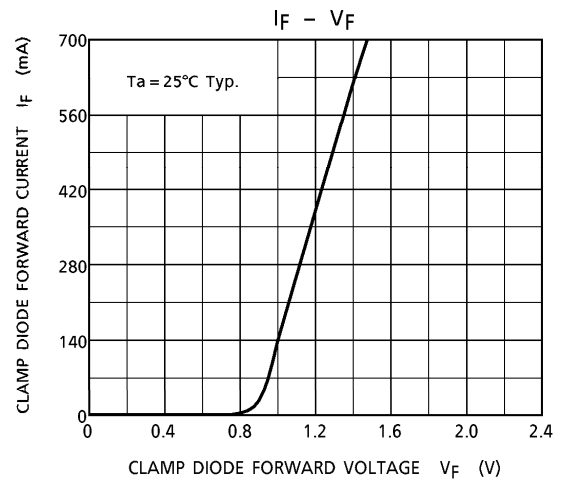
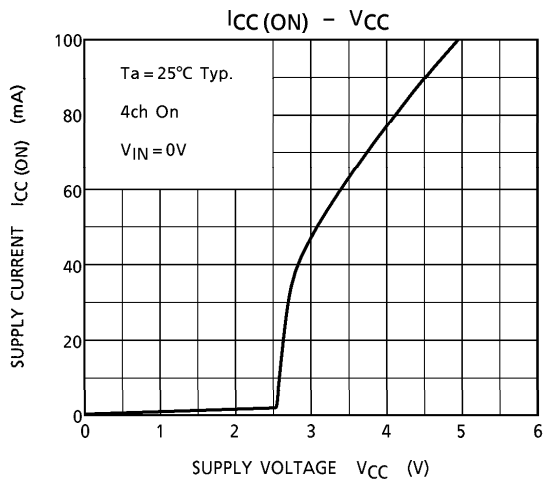
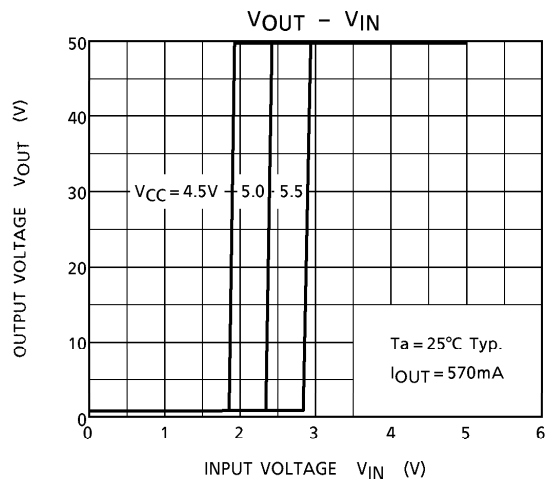
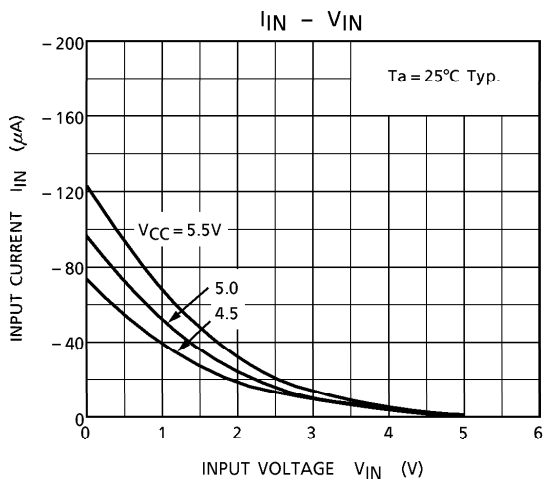

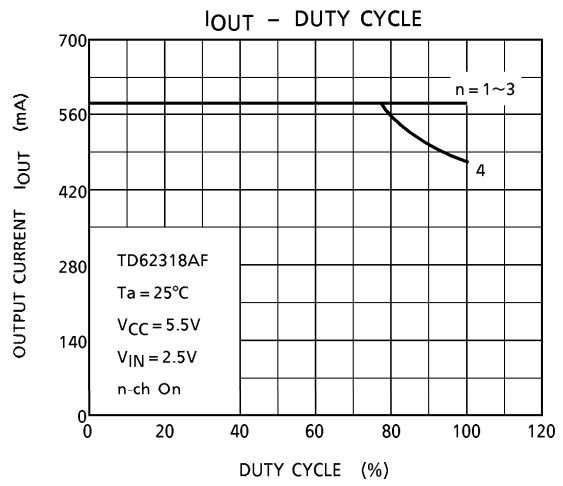
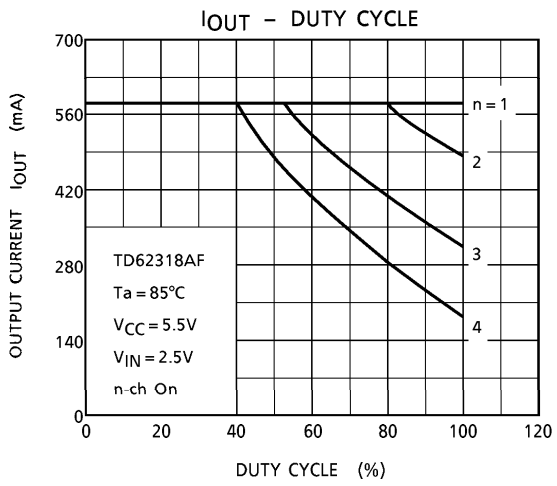
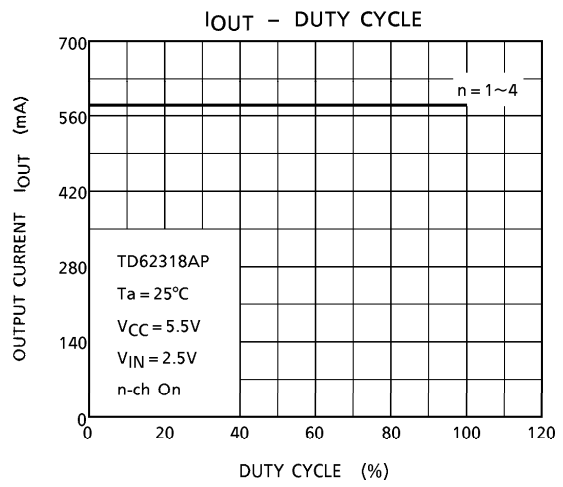
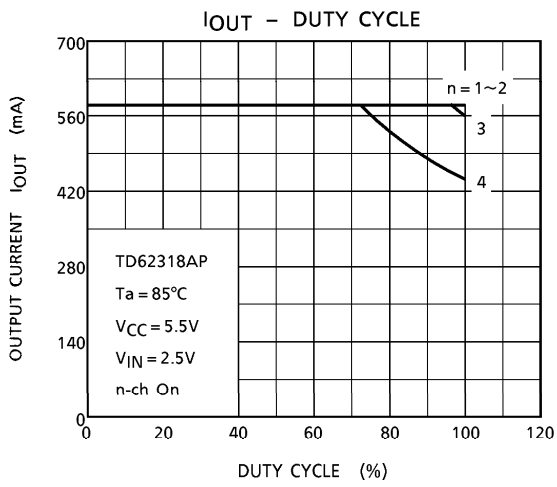

**OUTLINE DRAWING**  
DIP16-P-300-2.54A

Unit : mm

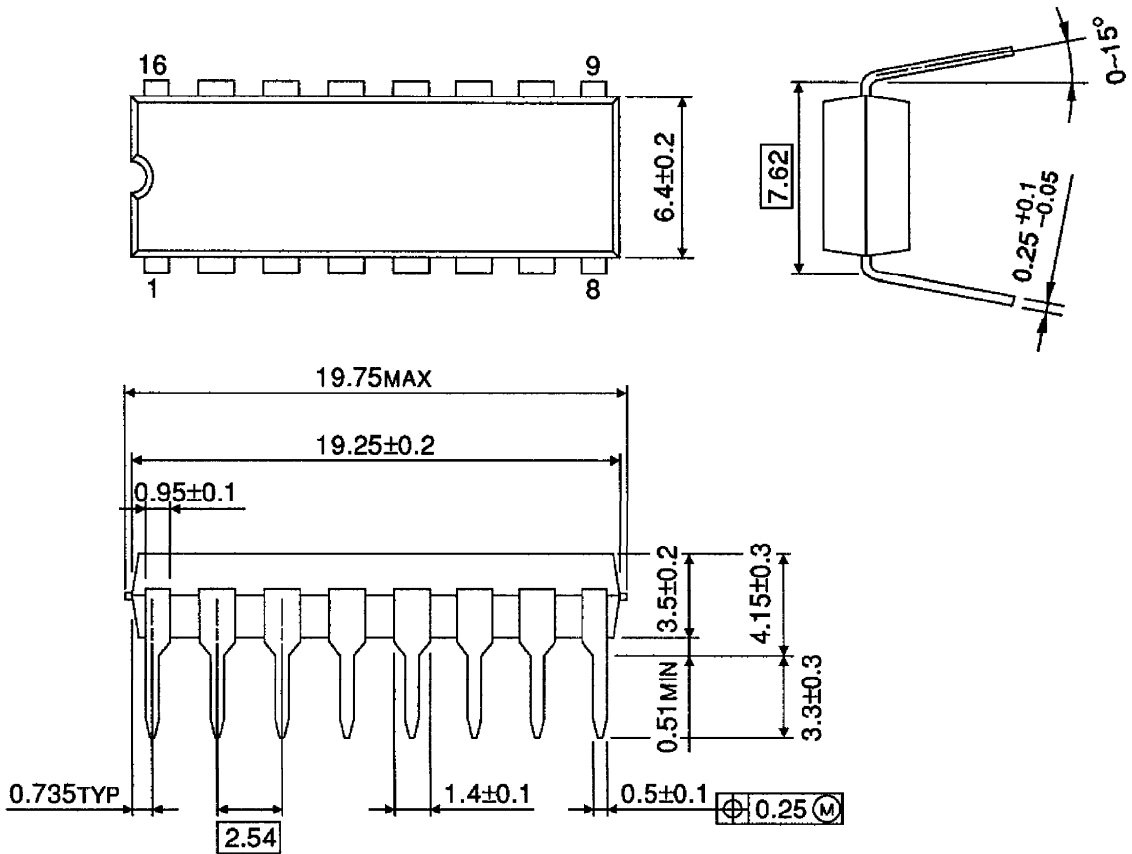

Weight : 1.11g (Typ.)

**OUTLINE DRAWING**  
HSOP16-P-300-1.00

Unit : mm

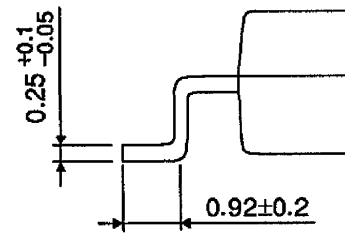
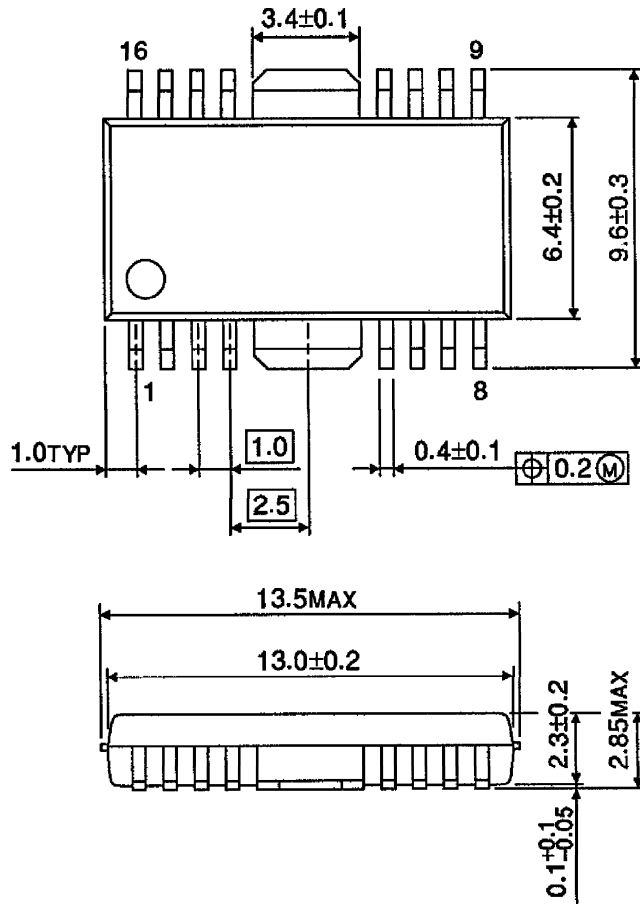

Weight : 0.50g (Typ.)



Copyright Each Manufacturing Company.

All Datasheets cannot be modified without permission.

This datasheet has been download from :

[www.AllDataSheet.com](http://www.AllDataSheet.com)

100% Free DataSheet Search Site.

Free Download.

No Register.

Fast Search System.

[www.AllDataSheet.com](http://www.AllDataSheet.com)