

ADVANCE INFORMATION

STEREO AF AMPLIFIER

The TEA2024 is an A.F. stereo amplifier in plastic package of 10 passages which is especially adapted for use in radio-cassette and low cost car-radio.

It has the capacity to supply an output power of 3.5 W per channel in the following conditions : $V_{CC} = 12 V$, $THD = 10 \%$, $R_L = 4 \Omega$.

- Low idle current
- Internal thermal protection
- Protection against short-circuit
- Single-in-line package
- Very few external components
- Excellent ripple rejection.

STEREO AF AMPLIFIER

CASE CB-313

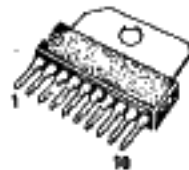

SP SUFFIX
PLASTIC PACKAGE

TYPICAL APPLICATION DUAL MODE

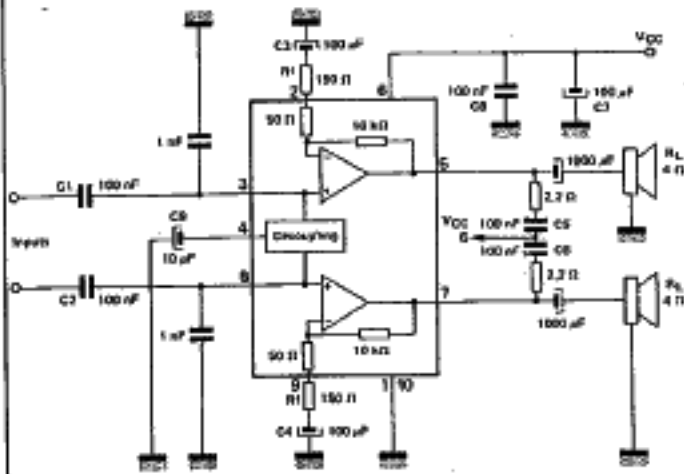

PIN ASSIGNMENT

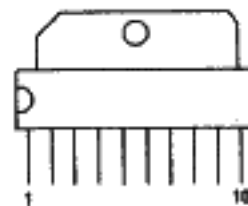

1. Ground (1)
2. Feedback (1)
3. Positive Input (1)
4. Decoupling
5. Output (1)
6. VCC (1)
7. Output (2)
8. Positive Input (2)
9. Feedback (2)
10. Ground (2)

T-74-05-01

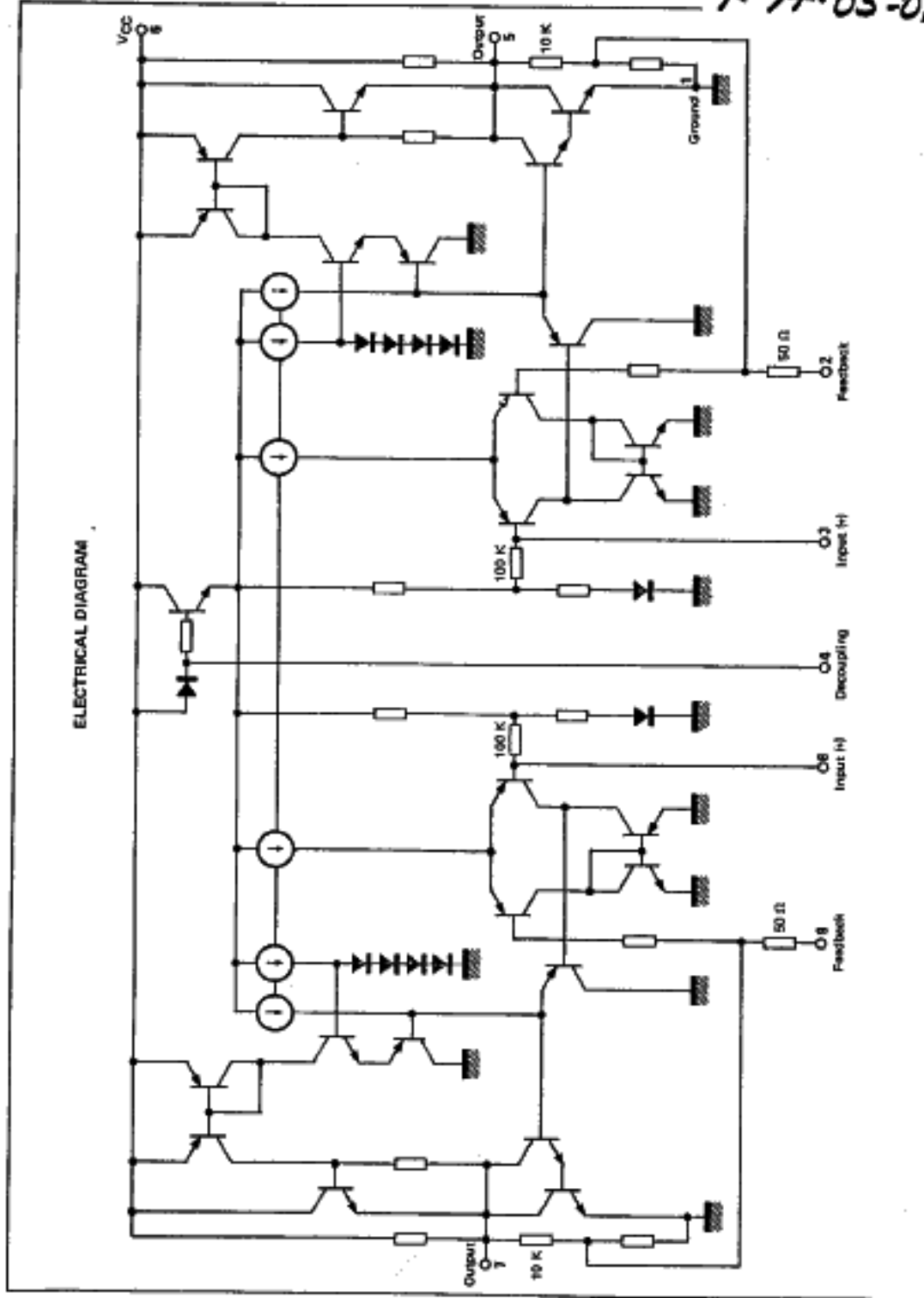

T-74-05-01

MAXIMUM RATINGS

Rating	Symbol	Value	Unit
Supply voltage	V_{CC}	20	V
Operating supply voltage	V_{CC}	18	V
Power dissipation	P_{out}	See graphs	
Maximum output current	I_O	2.5	A
Storage or junction temperature	T_{stg}, T_j	-40, +180	$^{\circ}C$

THERMAL CHARACTERISTICS

Characteristic	Symbol	Value	Unit
Junction-ambient thermal resistance	$R_{\theta(j-a)}$	60	$^{\circ}C/W$
Junction-case thermal resistance	$R_{\theta(j-c)}$	9	$^{\circ}C/W$

ELECTRICAL CHARACTERISTICS

$V_{CC} = 12\text{ V}$, $T_{amb} = +25^{\circ}C$, $R_L = 4\ \Omega$, $A_V = 46\text{ dB}$, Dual mode (unless otherwise specified)

Characteristic	Symbol	Min	Typ	Max	Unit
Supply voltage range	V_{CC}	6	-	18	V
Supply current ($V_G = 0$)	I_{CC}	-	35	60	mA
D.C. output voltage ($V_{CC} = 12\text{ V}$)	V_{out}	6.4	6.0	6.6	V
Output power ($f = 1\text{ KHz}$; $d = 10\%$; $R_L = 4\ \Omega$)	P_{out}				W
Dual mode - per channel					
$V_{CC} = 12\text{ V}$		3	3.5	-	
$V_{CC} = 9\text{ V}$		-	1.75	-	
$V_{CC} = 6\text{ V}$		-	0.60	-	
$V_{CC} = 14.4\text{ V}$		-	5	-	
BTL mode - $V_{CC} = 12\text{ V}$		-	10	-	
Voltage gain without external resistance					dB
$R_f = 100\ \Omega$	A_{V1}	31	34	37	
$R_f = 0\ \Omega$	A_{V2}	-	46	-	
Distortion ($f = 1\text{ KHz}$; $V_{CC} = 12\text{ V}$; $R_L = 4\ \Omega$; $P_{out} 0.5\text{ to }2\text{ W}$)	d	-	0.3	1.6	%
Input noise voltage ($R_G = 0$; $B = 20\text{ KHz}$)		-	2	-	μV
Supply voltage ripple rejection	SVR				dB
Fripple = 100 Hz; $V_{ripple} = 0.5V_{RMS}$; $R_G = 0$		40	50	-	
Crosstalk ($f = 1\text{ KHz}$; $R_G = 10\text{ K}$)	CT	40	52	-	dB
Frequency response (3 dB) - ($P_{out} = 1\text{ W}$; $R_L = 4\ \Omega$)	B	-	0.015 - 40	-	KHz
Open loop gain		-	80	-	dB

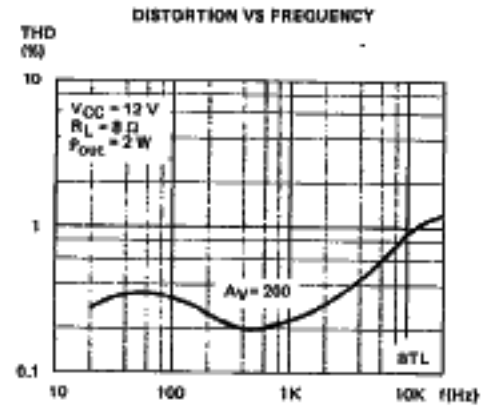
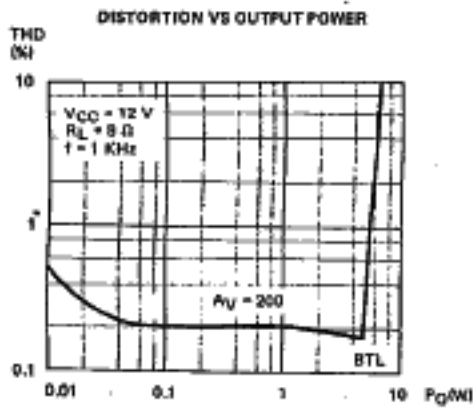
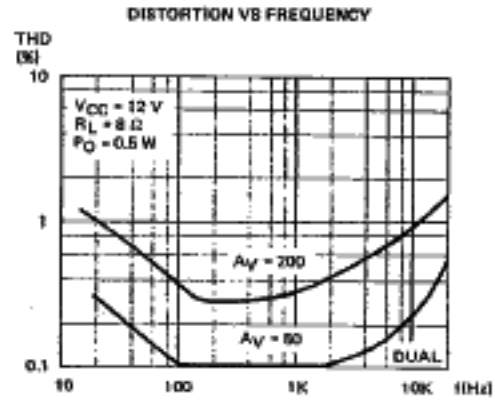
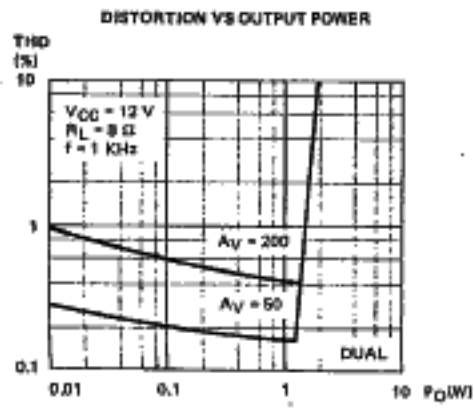
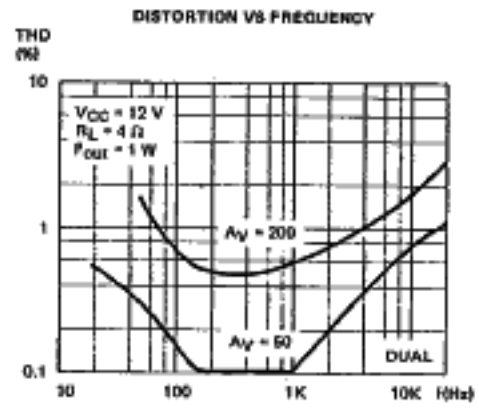
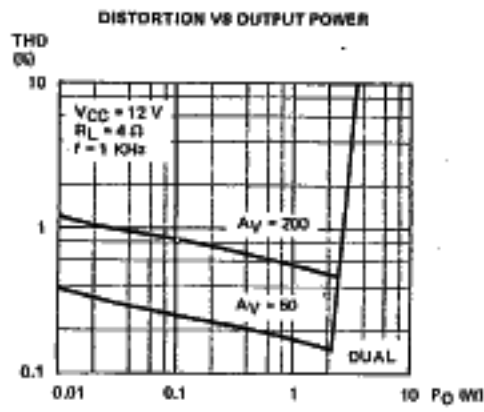

T-74-05-01

CROSSTALK VS FREQUENCY

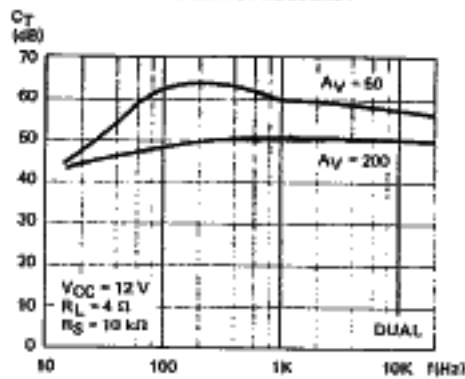

SUPPLY VOLTAGE RIPPLE REJECTION VS FREQUENCY

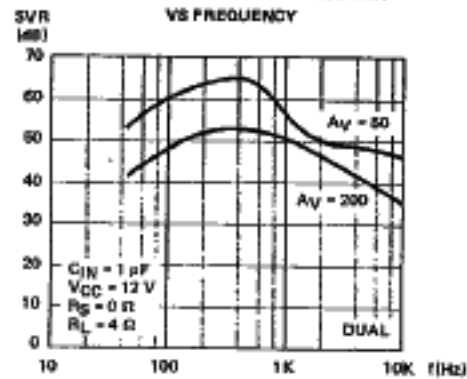

TOTAL DISSIPATED POWER VS OUTPUT POWER

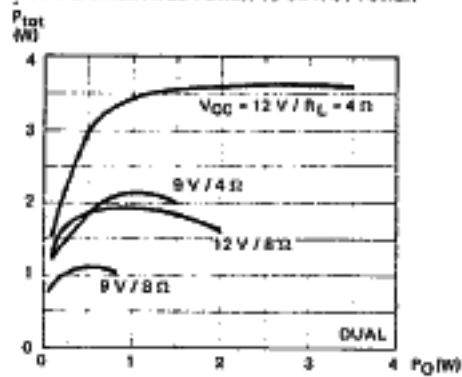

OUTPUT POWER VS SUPPLY VOLTAGE

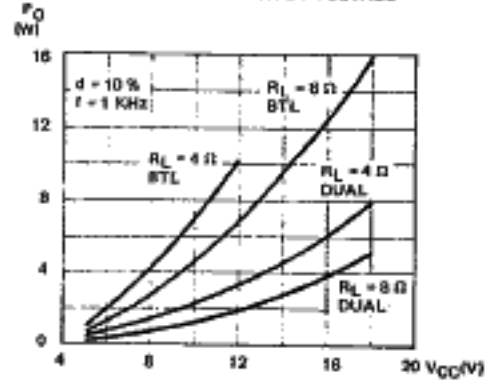

SUPPLY VOLTAGE RIPPLE REJECTION VS FREQUENCY

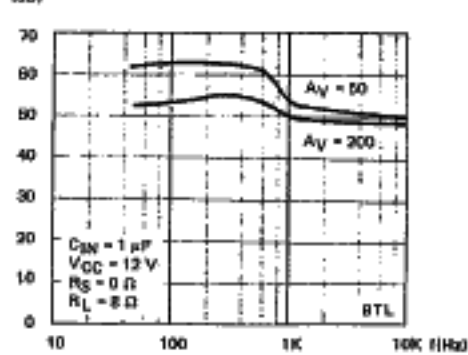

TOTAL DISSIPATED POWER VS OUTPUT POWER

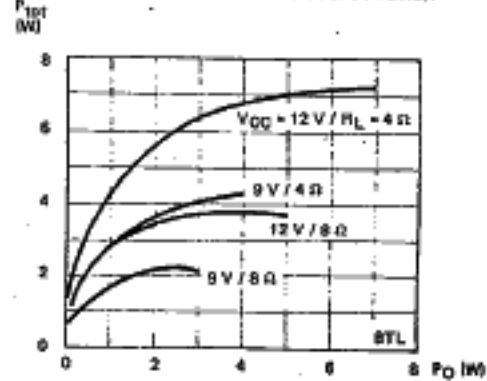

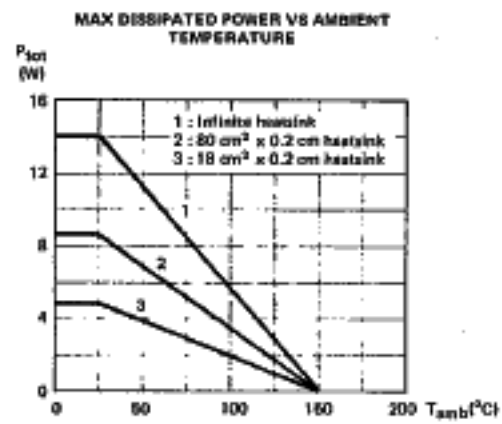
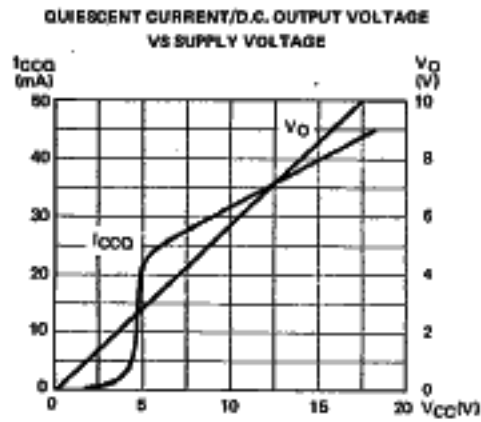

BRIDGE MODE

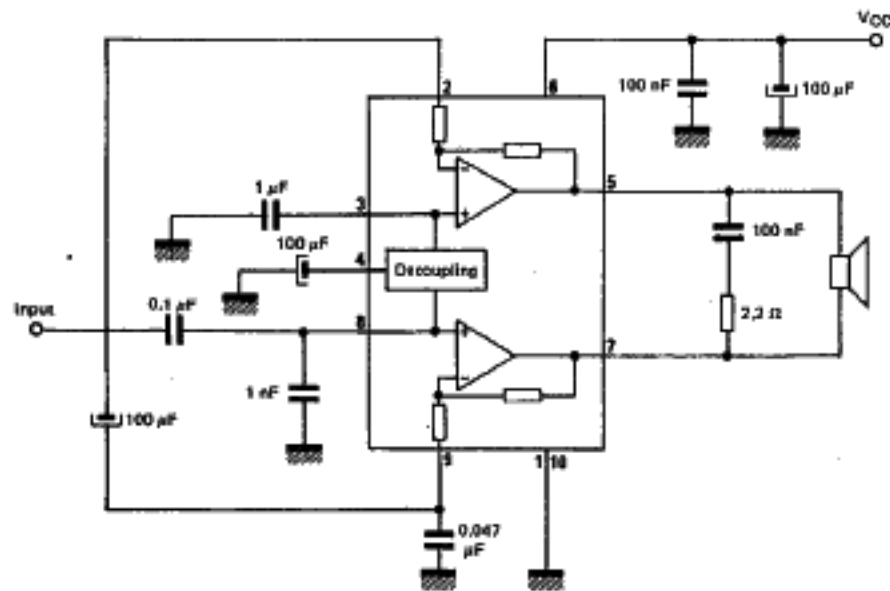

APPLICATION INFORMATION

T-74-05-01

GROUND CONNECTION

Two ground pins are provided and must be connected together on the PC board. The GND connections for power - return from the load and negative supply - must be kept separated from the signal and feed-back ground. Inappropriate ground connections will cause parasitic oscillation, distortion and cross-talk.

VOLTAGE GAIN

The voltage gain is determined by the ratio of internal

feedback resistors and external resistor R_f .

$$G_v = 34 \text{ dB for } R_f = 150 \Omega$$

$$G_v = 45 \text{ dB for } R_f = 0 \Omega$$

CAPACITORS C5 AND C6

These capacitors must be connected close to the I.C. connections. Low temp-coefficient type will give the best results to prevent oscillations.

1 nF ceramic capacitors bypassing inputs to ground will help prevent high oscillations or radio interference.

OUTPUT POWER TABLE (TYPICAL VALUE)					
THD = 10% ; f = 1 KHz ; T _{amb} = + 25°C					
LOAD	VCC	6 V	9 V	12 V	14.4 V
	DUAL	8 Ω	—	1 W/ch	1.8 W/ch
4 Ω		0.8 W/ch	1.8 W/ch	3.5 W/ch	6 W/ch
BTL	8 Ω	1.2 W	3.5 W	6.7 W	10.5 W
	4 Ω	2.0 W	6.3 W	10 W	—

DUAL and BTL MODES
PRINTED CIRCUIT BOARD

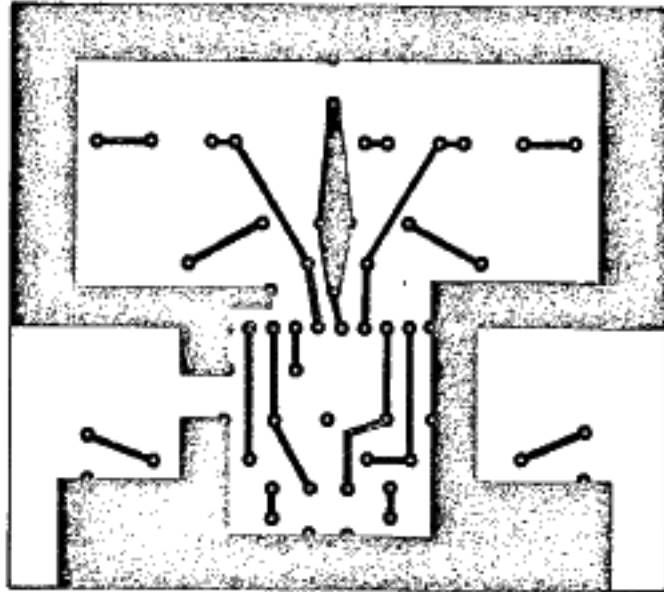

T-74-05-01

COMPONENT LAYOUT (DUAL MODE)

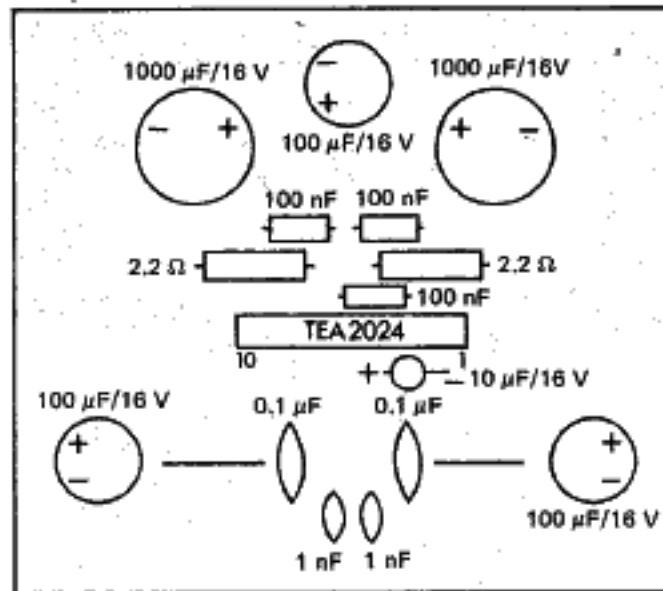

COMPONENT LAYOUT (BRIDGE MODE)

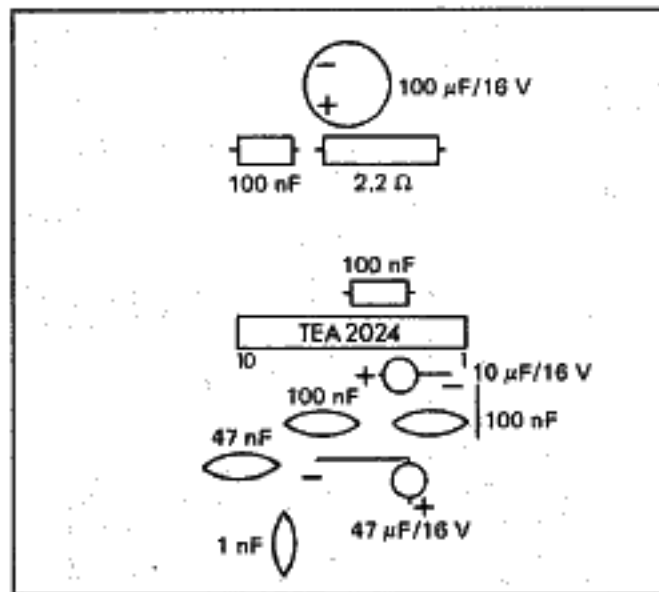

T-74-05-01

CASE CB-313

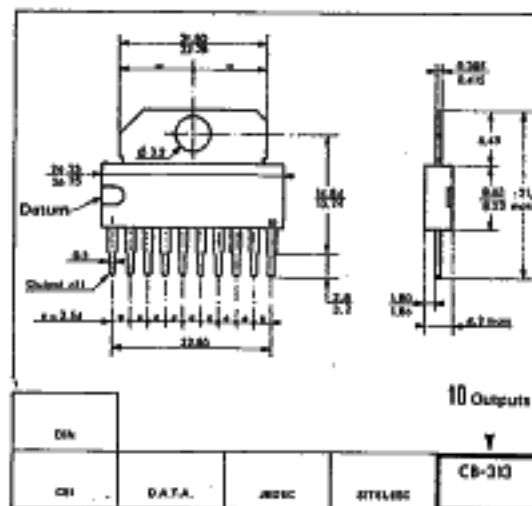
SP SUFFIX
PLASTIC PACKAGE

This is advance information and specifications are subject to change without notice.
Please inquire with our sales offices about the availability of the different packages.

Copyright © Each Manufacturing Company.

All Datasheets cannot be modified without permission.

This datasheet has been download from :

www.AllDataSheet.com

100% Free DataSheet Search Site.

Free Download.

No Register.

Fast Search System.

www.AllDataSheet.com