

- **High Speed**
  - 70 MHz Bandwidth ( $G = 1$ ,  $-3$  dB)
  - 240 V/ $\mu$ s Slew Rate
  - 60-ns Settling Time (0.1%)
- **High Output Drive,  $I_O = 100$  mA (typ)**
- **Excellent Video Performance**
  - 0.1 dB Bandwidth of 30 MHz ( $G = 1$ )
  - 0.01% Differential Gain
  - 0.01° Differential Phase
- **Very Low Distortion**
  - THD =  $-82$  dBc ( $f = 1$  MHz,  $R_L = 150 \Omega$ )
  - THD =  $-89$  dBc ( $f = 1$  MHz,  $R_L = 1$  k $\Omega$ )
- **Wide Range of Power Supplies**
  - $V_{CC} = \pm 5$  V to  $\pm 15$  V
- **Available in Standard SOIC, MSOP PowerPAD™, JG or FK Package**
- **Evaluation Module Available**

## description

The THS4051 and THS4052 are general-purpose, single/dual, high-speed voltage feedback amplifiers ideal for a wide range of applications including video, communication, and imaging. The devices offer very good ac performance with 70-MHz bandwidth, 240-V/ $\mu$ s slew rate, and 60-ns settling time (0.1%). The THS4051/2 are stable at all gains for both inverting and non-inverting configurations. These amplifiers have a high output drive capability of 100 mA and draw only 8.5-mA supply current per channel. Excellent professional video results can be obtained with the low differential gain/phase errors of 0.01%/0.01° and wide 0.1 dB flatness to 30 MHz. For applications requiring low distortion, the THS4051/2 is ideally suited with total harmonic distortion of  $-82$  dBc at 1 MHz.

RELATED DEVICES	
DEVICE	DESCRIPTION
THS4011/2	290-MHz Low Distortion High-Speed Amplifiers
THS4031/2	100-MHz Low Noise High-Speed Amplifiers
THS4081/2	175-MHz Low Power High-Speed Amplifiers

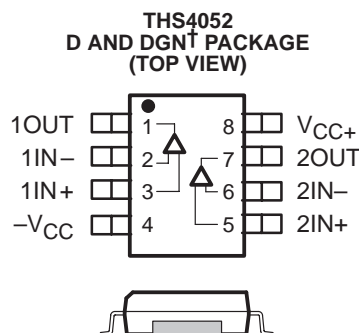
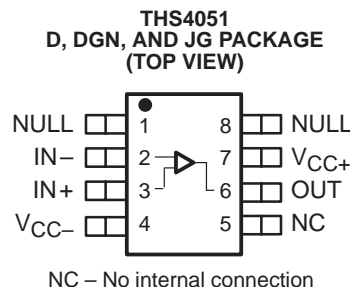

Cross Section View Showing PowerPAD™ Option (DGN)

† This device is in the Product Preview stage of development. Please contact your local TI sales office for availability.

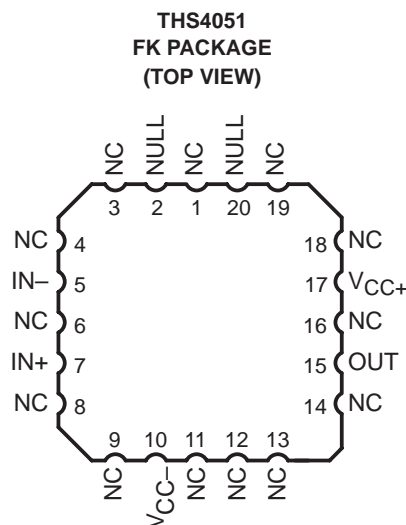

**CAUTION:** The THS4051 and THS4052 provide ESD protection circuitry. However, permanent damage can still occur if this device is subjected to high-energy electrostatic discharges. Proper ESD precautions are recommended to avoid any performance degradation or loss of functionality.



Please be aware that an important notice concerning availability, standard warranty, and use in critical applications of Texas Instruments semiconductor products and disclaimers thereto appears at the end of this data sheet.

PowerPAD is a trademark of Texas Instruments.

PRODUCTION DATA information is current as of publication date. Products conform to specifications per the terms of Texas Instruments standard warranty. Production processing does not necessarily include testing of all parameters.



# THS4051, THS4052 70-MHz HIGH-SPEED AMPLIFIERS

SLOS238C—MAY 1999—REVISED MAY 2000

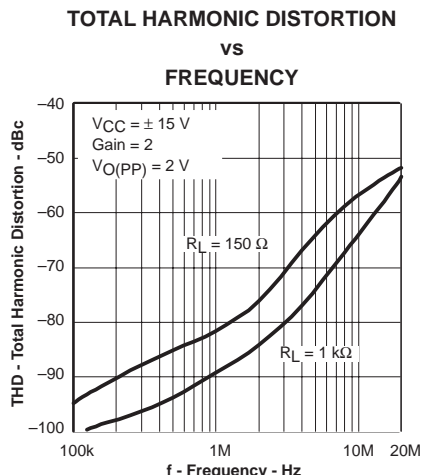

### AVAILABLE OPTIONS

T <sub>A</sub>	NUMBER OF CHANNELS	PACKAGED DEVICES					EVALUATION MODULE
		PLASTIC SMALL OUTLINE† (D)	PLASTIC MSOP† (DGN)		CERAMIC DIP (JG)	CHIP CARRIER (FK)	
			DEVICE	SYMBOL			
0°C to 70°C	1	THS4051CD	THS4051CDGN	ACQ	—	—	THS4051EVM
	2	THS4052CD	THS4052CDGN‡	ACE	—	—	THS4052EVM
-40°C to 85°C	1	THS4051ID	THS4051IDGN	ACR	—	—	—
	2	THS4052ID	THS4052IDGN‡	ACF	—	—	—
-55°C to 125°C	1	—	—	—	THS4051MJG	THS4051MFK	—

† The D and DGN packages are available taped and reeled. Add an R suffix to the device type (i.e., THS4051CDGN).

‡ This device is in the Product Preview stage of development. Please contact your local TI sales office for availability.

### functional block diagram

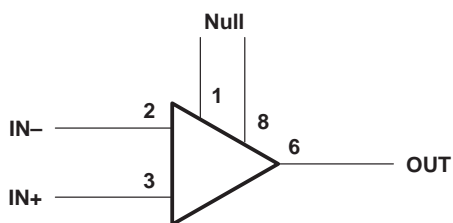

Figure 1. THS4051 – Single Channel

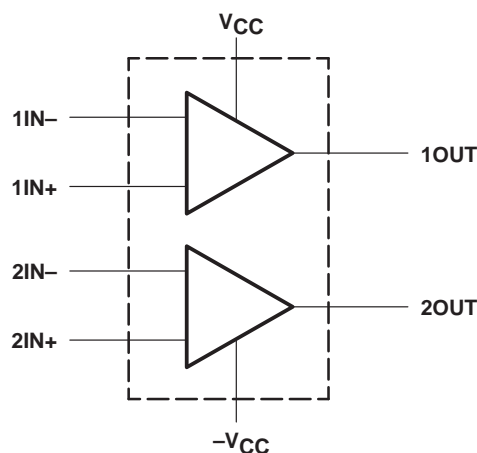

Figure 2. THS4052 – Dual Channel

**absolute maximum ratings over operating free-air temperature (unless otherwise noted)†**

Supply voltage, $V_{CC}$	.....	$\pm 16.5$ V
Input voltage, $V_I$	.....	$\pm V_{CC}$
Output current, $I_O$	.....	150 mA
Differential input voltage, $V_{IO}$	.....	$\pm 4$ V
Continuous total power dissipation	.....	See Dissipation Rating Table
Maximum junction temperature, $T_J$	.....	150°C
Operating free-air temperature, $T_A$ :	C-suffix	0°C to 70°C
	I-suffix	–40°C to 85°C
	M-suffix	–55°C to 125°C
Storage temperature, $T_{stg}$	.....	–65°C to 150°C
Lead temperature 1,6 mm (1/16 inch) from case for 10 seconds	.....	300°C
Lead temperature 1,6 mm (1/16 inch) from case for 60 seconds, JG package	.....	300°C
Case temperature for 60 seconds, FK package	.....	260°C

† Stresses beyond those listed under “absolute maximum ratings” may cause permanent damage to the device. These are stress ratings only and functional operation of the device at these or any other conditions beyond those indicated under “recommended operating conditions” is not implied. Exposure to absolute-maximum-rated conditions for extended periods may affect device reliability.

**DISSIPATION RATING TABLE**

PACKAGE	$\theta_{JA}$ (°C/W)	$\theta_{JC}$ (°C/W)	$T_A = 25^\circ\text{C}$ POWER RATING
D	167‡	38.3	740 mW
DGN§	58.4	4.7	2.14 W
JG	119	28	1050 mW
FK	87.7	20	1375 mW

‡ This data was taken using the JEDEC standard Low-K test PCB. For the JEDEC Proposed High-K test PCB, the  $\theta_{JA}$  is 95°C/W with a power rating at  $T_A = 25^\circ\text{C}$  of 1.32 W.

§ This data was taken using 2 oz. trace and copper pad that is soldered directly to a 3 in. × 3 in. PC. For further information, refer to *Application Information* section of this data sheet.

**recommended operating conditions**

		MIN	NOM	MAX	UNIT
Supply voltage, $V_{CC+}$ and $V_{CC-}$	Dual supply	$\pm 4.5$		$\pm 16$	V
	Single supply	9		32	
Operating free-air temperature, $T_A$	C-suffix	0		70	°C
	I-suffix	–40		85	
	M-suffix	–55		125	

# THS4051, THS4052 70-MHz HIGH-SPEED AMPLIFIERS

SLOS238C–MAY 1999 – REVISED MAY 2000

electrical characteristics at  $T_A = 25^\circ\text{C}$ ,  $V_{CC} = \pm 15\text{ V}$ ,  $R_L = 150\ \Omega$  (unless otherwise noted)

## dynamic performance

PARAMETER		TEST CONDITIONST		THS405xC, THS405xI			UNIT
				MIN	TYP	MAX	
BW	Dynamic performance small-signal bandwidth (-3 dB)	$V_{CC} = \pm 15\text{ V}$	Gain = 1	70			MHz
		$V_{CC} = \pm 5\text{ V}$		70			
		$V_{CC} = \pm 15\text{ V}$	Gain = 2	38			MHz
		$V_{CC} = \pm 5\text{ V}$		38			
	Bandwidth for 0.1 dB flatness	$V_{CC} = \pm 15\text{ V}$	Gain = 1	30			MHz
		$V_{CC} = \pm 5\text{ V}$		30			
Full power bandwidth§	$V_{O(pp)} = 20\text{ V}$ , $V_{CC} = \pm 15\text{ V}$		3.8			MHz	
	$V_{O(pp)} = 5\text{ V}$ , $V_{CC} = \pm 5\text{ V}$		12.7				
SR	Slew rate‡	$V_{CC} = \pm 15\text{ V}$ , 20-V step,	Gain = 5	240			V/ $\mu\text{s}$
		$V_{CC} = \pm 5\text{ V}$ , 5-V step	Gain = -1	200			
$t_s$	Settling time to 0.1%	$V_{CC} = \pm 15\text{ V}$ , 5-V step	Gain = -1	60			ns
		$V_{CC} = \pm 5\text{ V}$ , 2-V step		60			
	Settling time to 0.01%	$V_{CC} = \pm 15\text{ V}$ , 5-V step	Gain = -1	130			ns
		$V_{CC} = \pm 5\text{ V}$ , 2-V step		140			

† Full range =  $0^\circ\text{C}$  to  $70^\circ\text{C}$  for C suffix and  $-40^\circ\text{C}$  to  $85^\circ\text{C}$  for I suffix

‡ Slew rate is measured from an output level range of 25% to 75%.

§ Full power bandwidth =  $\text{slew rate} / 2\pi V_{O(\text{Peak})}$ .

## noise/distortion performance

PARAMETER		TEST CONDITIONST		THS405xC, THS405xI			UNIT	
				MIN	TYP	MAX		
THD	Total harmonic distortion	$V_{O(pp)} = 2\text{ V}$ , $f = 1\text{ MHz}$ , Gain = 2	$V_{CC} = \pm 15\text{ V}$	$R_L = 150\ \Omega$	-82			dBc
				$R_L = 1\text{ k}\Omega$	-89			
			$V_{CC} = \pm 5\text{ V}$	$R_L = 150\ \Omega$	-78			
				$R_L = 1\text{ k}\Omega$	-87			
$V_n$	Input voltage noise	$V_{CC} = \pm 5\text{ V}$ or $\pm 15\text{ V}$ ,	$f = 10\text{ kHz}$	14			$\text{nV}/\sqrt{\text{Hz}}$	
$I_n$	Input current noise	$V_{CC} = \pm 5\text{ V}$ or $\pm 15\text{ V}$ ,	$f = 10\text{ kHz}$	0.9			$\text{pA}/\sqrt{\text{Hz}}$	
Differential gain error	Gain = 2, 40 IRE modulation,	NTSC, $\pm 100\text{ IRE}$ ramp	$V_{CC} = \pm 15\text{ V}$	0.01%				
			$V_{CC} = \pm 5\text{ V}$	0.01%				
Differential phase error	Gain = 2, 40 IRE modulation,	NTSC, $\pm 100\text{ IRE}$ ramp	$V_{CC} = \pm 15\text{ V}$	0.01°				
			$V_{CC} = \pm 5\text{ V}$	0.03°				
Channel-to-channel crosstalk (THS4052 only)		$V_{CC} = \pm 5\text{ V}$ or $\pm 15\text{ V}$ ,	$f = 1\text{ MHz}$	-57			dB	

† Full range =  $0^\circ\text{C}$  to  $70^\circ\text{C}$  for C suffix and  $-40^\circ\text{C}$  to  $85^\circ\text{C}$  for I suffix.



electrical characteristics at  $T_A = 25^\circ\text{C}$ ,  $V_{CC} = \pm 15\text{ V}$ ,  $R_L = 150\ \Omega$  (unless otherwise noted) (continued)

dc performance

PARAMETER	TEST CONDITIONS†	THS405xC, THS405xI			UNIT
		MIN	TYP	MAX	
Open loop gain	$V_{CC} = \pm 15\text{ V}$ , $R_L = 1\text{ k}\Omega$ $V_O = \pm 10\text{ V}$	$T_A = 25^\circ\text{C}$	5	9	V/mV
		$T_A = \text{full range}$	3		
	$V_{CC} = \pm 5\text{ V}$ , $R_L = 250\ \Omega$ $V_O = \pm 2.5\text{ V}$	$T_A = 25^\circ\text{C}$	2.5	6	V/mV
		$T_A = \text{full range}$	2		
$V_{OS}$ Input offset voltage	$V_{CC} = \pm 5\text{ V}$ or $\pm 15\text{ V}$	$T_A = 25^\circ\text{C}$	2.5	10	mV
		$T_A = \text{full range}$	12		
Offset voltage drift	$V_{CC} = \pm 5\text{ V}$ or $\pm 15\text{ V}$	$T_A = \text{full range}$	15		$\mu\text{V}/^\circ\text{C}$
$I_{IB}$ Input bias current	$V_{CC} = \pm 5\text{ V}$ or $\pm 15\text{ V}$	$T_A = 25^\circ\text{C}$	2.5	6	$\mu\text{A}$
		$T_A = \text{full range}$	8		
$I_{OS}$ Input offset current	$V_{CC} = \pm 5\text{ V}$ or $\pm 15\text{ V}$	$T_A = 25^\circ\text{C}$	35	250	nA
		$T_A = \text{full range}$	400		
Offset current drift	$T_A = \text{full range}$		0.3		$\text{nA}/^\circ\text{C}$

† Full range =  $0^\circ\text{C}$  to  $70^\circ\text{C}$  for C suffix and  $-40^\circ\text{C}$  to  $85^\circ\text{C}$  for I suffix

input characteristics

PARAMETER	TEST CONDITION†	THS405xC, THS405xI			UNIT
		MIN	TYP	MAX	
$V_{ICR}$ Common-mode input voltage range	$V_{CC} = \pm 15\text{ V}$	$\pm 13.8$	$\pm 14.3$		V
	$V_{CC} = \pm 5\text{ V}$	$\pm 3.8$	$\pm 4.3$		
CMRR Common mode rejection ratio	$V_{CC} = \pm 15\text{ V}$ , $V_{ICR} = \pm 12\text{ V}$	70	100		dB
	$V_{CC} = \pm 5\text{ V}$ , $V_{ICR} = \pm 2.5\text{ V}$	70	100		
$r_i$ Input resistance			1		M $\Omega$
$C_i$ Input capacitance			1.5		pF

† Full range =  $0^\circ\text{C}$  to  $70^\circ\text{C}$  for C suffix and  $-40^\circ\text{C}$  to  $85^\circ\text{C}$  for I suffix

output characteristics

PARAMETER	TEST CONDITIONS†	THS405xC, THS405xI			UNIT
		MIN	TYP	MAX	
$V_O$ Output voltage swing	$V_{CC} = \pm 15\text{ V}$ $R_L = 250\ \Omega$	$\pm 11.5$	$\pm 13$		V
	$V_{CC} = \pm 5\text{ V}$ $R_L = 150\ \Omega$	$\pm 3.2$	$\pm 3.5$		
	$V_{CC} = \pm 15\text{ V}$ $R_L = 1\text{ k}\Omega$	$\pm 13$	$\pm 13.6$		V
	$V_{CC} = \pm 5\text{ V}$ $R_L = 1\text{ k}\Omega$	$\pm 3.5$	$\pm 3.8$		
$I_O$ Output current‡	$V_{CC} = \pm 15\text{ V}$ $R_L = 20\ \Omega$	80	100		mA
	$V_{CC} = \pm 5\text{ V}$ $R_L = 20\ \Omega$	50	75		
$I_{SC}$ Short-circuit current‡	$V_{CC} = \pm 15\text{ V}$		150		mA
$R_O$ Output resistance	Open loop		13		$\Omega$

† Full range =  $0^\circ\text{C}$  to  $70^\circ\text{C}$  for C suffix and  $-40^\circ\text{C}$  to  $85^\circ\text{C}$  for I suffix

‡ Observe power dissipation ratings to keep the junction temperature below the absolute maximum rating when the output is heavily loaded or shorted. See the absolute maximum ratings section of this data sheet for more information.

# THS4051, THS4052 70-MHz HIGH-SPEED AMPLIFIERS

SLOS238C–MAY 1999 – REVISED MAY 2000

electrical characteristics at  $T_A = 25^\circ\text{C}$ ,  $V_{CC} = \pm 15\text{ V}$ ,  $R_L = 150\ \Omega$  (unless otherwise noted) (continued)

## power supply

PARAMETER		TEST CONDITIONS†		THS405xC, THS405xI			UNIT
				MIN	TYP	MAX	
$V_{CC}$	Supply voltage operating range	Dual supply		$\pm 4.5$		$\pm 16.5$	V
		Single supply		9		33	
$I_{CC}$	Supply current (per amplifier)	$V_{CC} = \pm 15\text{ V}$	$T_A = 25^\circ\text{C}$	8.5	10.5	mA	
			$T_A = \text{full range}$		11.5		
		$V_{CC} = \pm 5\text{ V}$	$T_A = 25^\circ\text{C}$	7.5	9.5		
			$T_A = \text{full range}$		10.5		
PSRR	Power supply rejection ratio	$V_{CC} = \pm 5\text{ V}$ or $\pm 15\text{ V}$	$T_A = 25^\circ\text{C}$	70	84	dB	
			$T_A = \text{full range}$	68			

† Full range =  $0^\circ\text{C}$  to  $70^\circ\text{C}$  for C suffix and  $-40^\circ\text{C}$  to  $85^\circ\text{C}$  for I suffix

electrical characteristics at  $T_A = \text{full range}$ ,  $V_{CC} = \pm 15\text{ V}$ ,  $R_L = 1\text{ k}\Omega$  (unless otherwise noted)

## dynamic performance

PARAMETER		TEST CONDITIONS†		THS4051M			UNIT
				MIN	TYP	MAX	
BW	Unity gain bandwidth	$V_{CC} = \pm 15\text{ V}$ , Closed loop	$R_L = 1\text{ k}\Omega$	50§	70		MHz
	Dynamic performance small-signal bandwidth (-3 dB)	$V_{CC} = \pm 15\text{ V}$	Gain = 1		70		MHz
		$V_{CC} = \pm 5\text{ V}$	Gain = 1		70		
		$V_{CC} = \pm 15\text{ V}$	Gain = 2		38		
		$V_{CC} = \pm 5\text{ V}$	Gain = 2		38		
	Bandwidth for 0.1 dB flatness	$V_{CC} = \pm 15\text{ V}$	Gain = 1		30		MHz
$V_{CC} = \pm 5\text{ V}$		Gain = 1		30			
Full power bandwidth‡		$V_{O(pp)} = 20\text{ V}$ , $V_{CC} = \pm 15\text{ V}$			3.8		MHz
		$V_{O(pp)} = 5\text{ V}$ , $V_{CC} = \pm 5\text{ V}$			12.7		
SR	Slew rate	$V_{CC} = \pm 15\text{ V}$ ,	$R_L = 1\text{ k}\Omega$	240§	300		$\text{V}/\mu\text{s}$
		$V_{CC} = \pm 5\text{ V}$ , 5-V step	Gain = -1		200		
$t_s$	Settling time to 0.1%	$V_{CC} = \pm 15\text{ V}$ , 5-V step	Gain = -1		60		ns
		$V_{CC} = \pm 5\text{ V}$ , 2-V step	Gain = -1		60		
	Settling time to 0.01%	$V_{CC} = \pm 15\text{ V}$ , 5-V step	Gain = -1		130		ns
		$V_{CC} = \pm 5\text{ V}$ , 2-V step	Gain = -1		140		

† Full range =  $-55^\circ\text{C}$  to  $125^\circ\text{C}$  for the THS4051M.

‡ Full power bandwidth =  $\text{slew rate}/2\pi V_{O(\text{Peak})}$ .

§ This parameter is not tested.



electrical characteristics at  $T_A$  = full range,  $V_{CC} = \pm 15$  V,  $R_L = 1$  k $\Omega$  (unless otherwise noted)

noise/distortion performance

PARAMETER	TEST CONDITION <sup>†</sup>		THS4051M			UNIT
			MIN	TYP	MAX	
THD Total harmonic distortion	$V_{O(pp)} = 2$ V, $f = 1$ MHz, Gain = 2, $T_A = 25^\circ\text{C}$	$V_{CC} = \pm 15$ V	$R_L = 150 \Omega$	–82		dBc
			$R_L = 1$ k $\Omega$	–89		
		$V_{CC} = \pm 5$ V	$R_L = 150 \Omega$	–78		
			$R_L = 1$ k $\Omega$	–87		
$V_n$ Input voltage noise	$V_{CC} = \pm 5$ V or $\pm 15$ V, $T_A = 25^\circ\text{C}$	$f = 10$ kHz,	$R_L = 150 \Omega$	14		nV/ $\sqrt{\text{Hz}}$
$I_n$ Input current noise	$V_{CC} = \pm 5$ V or $\pm 15$ V, $T_A = 25^\circ\text{C}$	$f = 10$ kHz,	$R_L = 150 \Omega$	0.9		pA/ $\sqrt{\text{Hz}}$
Differential gain error	Gain = 2, 40 IRE modulation, $T_A = 25^\circ\text{C}$ ,	NTSC, $\pm 100$ IRE ramp, $R_L = 150 \Omega$	$V_{CC} = \pm 15$ V	0.01%		
			$V_{CC} = \pm 5$ V	0.01%		
Differential phase error	Gain = 2, 40 IRE modulation, $T_A = 25^\circ\text{C}$ ,	NTSC, $\pm 100$ IRE ramp, $R_L = 150 \Omega$	$V_{CC} = \pm 15$ V	0.01°		
			$V_{CC} = \pm 5$ V	0.03°		

<sup>†</sup> Full range =  $-55^\circ\text{C}$  to  $125^\circ\text{C}$  for the THS4051M.

dc performance

PARAMETER	TEST CONDITION <sup>†</sup>		THS4051M			UNIT
			MIN	TYP	MAX	
Open loop gain	$V_{CC} = \pm 15$ V, $V_O = \pm 10$ V	$T_A = 25^\circ\text{C}$	5	9		V/mV
		$T_A = \text{full range}$	3			
	$V_{CC} = \pm 5$ V, $V_O = \pm 2.5$ V	$T_A = 25^\circ\text{C}$	2.5	6		V/mV
		$T_A = \text{full range}$	2			
$V_{IO}$ Input offset voltage	$V_{CC} = \pm 5$ V or $\pm 15$ V	$T_A = 25^\circ\text{C}$	2.5		mV	
Offset voltage drift		$T_A = \text{full range}$	13			
Offset voltage drift	$V_{CC} = \pm 5$ V or $\pm 15$ V	$T_A = \text{full range}$	15		$\mu\text{V}/^\circ\text{C}$	
$I_{IB}$ Input bias current	$V_{CC} = \pm 5$ V or $\pm 15$ V	$T_A = 25^\circ\text{C}$	2.5		$\mu\text{A}$	
		$T_A = \text{full range}$	8			
$I_{IO}$ Input offset current	$V_{CC} = \pm 5$ V or $\pm 15$ V	$T_A = 25^\circ\text{C}$	35	250		nA
		$T_A = \text{full range}$	400			
Offset current drift	$T_A = \text{full range}$		0.3		nA/ $^\circ\text{C}$	

<sup>†</sup> Full range =  $-55^\circ\text{C}$  to  $125^\circ\text{C}$  for the THS4051M.

input characteristics

PARAMETER	TEST CONDITION <sup>†</sup>		THS4051M			UNIT	
			MIN	TYP	MAX		
$V_{ICR}$ Common-mode input voltage range	$V_{CC} = \pm 15$ V		$\pm 13.8$	$\pm 14.3$		V	
	$V_{CC} = \pm 5$ V		$\pm 3.8$	$\pm 4.3$			
CMRR Common mode rejection ratio	$V_{CC} = \pm 15$ V,	$V_{ICR} = \pm 12$ V	$T_A = \text{full range}$	70	100		dB
	$V_{CC} = \pm 5$ V,	$V_{ICR} = \pm 2.5$ V		70	100		
$r_i$ Input resistance			1			M $\Omega$	
$C_i$ Input capacitance			1.5			pF	

<sup>†</sup> Full range =  $-55^\circ\text{C}$  to  $125^\circ\text{C}$  for the THS4051M.

# THS4051, THS4052 70-MHz HIGH-SPEED AMPLIFIERS

SLOS238C–MAY 1999 – REVISED MAY 2000

electrical characteristics at  $T_A =$  full range,  $V_{CC} = \pm 15$  V,  $R_L = 1$  k $\Omega$  (unless otherwise noted)  
(continued)

## output characteristics

PARAMETER	TEST CONDITIONST		THS4051M			UNIT
			MIN	TYP	MAX	
$V_O$ Output voltage swing	$V_{CC} = \pm 15$ V	$R_L = 250 \Omega$	$\pm 12$	$\pm 13$		V
	$V_{CC} = \pm 5$ V	$R_L = 150 \Omega$	$\pm 3.2$	$\pm 3.5$		
	$V_{CC} = \pm 15$ V	$R_L = 1$ k $\Omega$	$\pm 13$	$\pm 13.6$		V
	$V_{CC} = \pm 5$ V		$\pm 3.5$	$\pm 3.8$		
$I_O$ Output current‡	$V_{CC} = \pm 15$ V, $T_A = 25^\circ\text{C}$	$R_L = 20 \Omega$	80	100		mA
	$V_{CC} = \pm 15$ V, $T_A =$ full range		70			
	$V_{CC} = \pm 5$ V		50	75		
$I_{SC}$ Short-circuit current‡	$V_{CC} = \pm 15$ V		150			mA
$R_O$ Output resistance	Open loop		13			$\Omega$

† Full range =  $-55^\circ\text{C}$  to  $125^\circ\text{C}$  for the THS4051M.

‡ Observe power dissipation ratings to keep the junction temperature below the absolute maximum rating when the output is heavily loaded or shorted. See the absolute maximum ratings section of this data sheet for more information.

## power supply

PARAMETER	TEST CONDITIONST		THS4051M			UNIT
			MIN	TYP	MAX	
$V_{CC}$ Supply voltage operating range	Dual supply		$\pm 4.5$		$\pm 16.5$	V
	Single supply		9		33	
$I_{CC}$ Supply current (per amplifier)	$V_{CC} = \pm 15$ V	$T_A = 25^\circ\text{C}$	8.5	10.5		mA
		$T_A =$ full range		11.5		
	$V_{CC} = \pm 5$ V	$T_A = 25^\circ\text{C}$	7.5	9.5		
		$T_A =$ full range		10.5		
PSRR Power supply rejection ratio	$V_{CC} = \pm 5$ V or $\pm 15$ V	$T_A =$ full range	70	84		dB

† Full range =  $-55^\circ\text{C}$  to  $125^\circ\text{C}$  for the THS4051M.





## TYPICAL CHARACTERISTICS

**INPUT OFFSET VOLTAGE  
vs  
FREE-AIR TEMPERATURE**

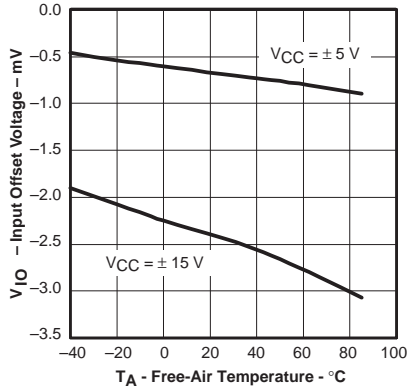

Figure 3

**INPUT BIAS CURRENT  
vs  
FREE-AIR TEMPERATURE**

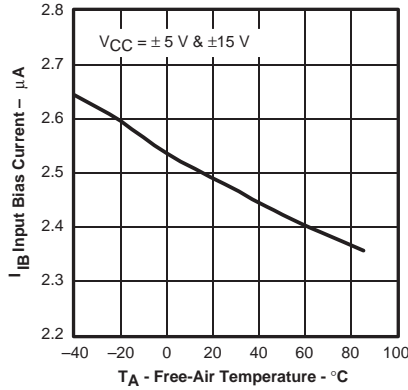

Figure 4

**OUTPUT VOLTAGE  
vs  
SUPPLY VOLTAGE**

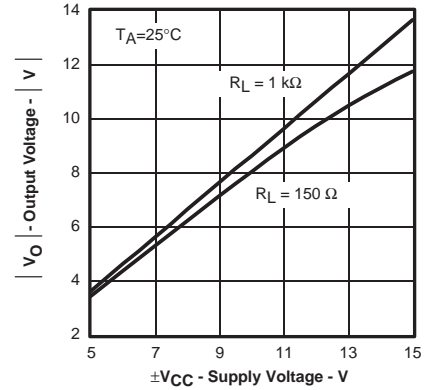

Figure 5

**COMMON-MODE INPUT VOLTAGE  
vs  
SUPPLY VOLTAGE**

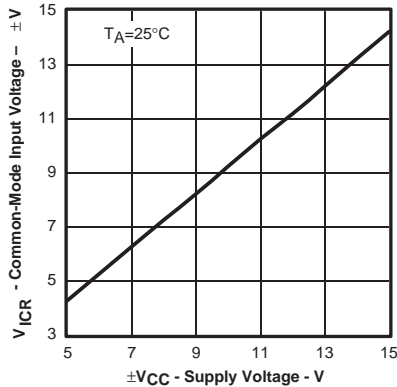

Figure 6

**OUTPUT VOLTAGE  
vs  
FREE-AIR TEMPERATURE**

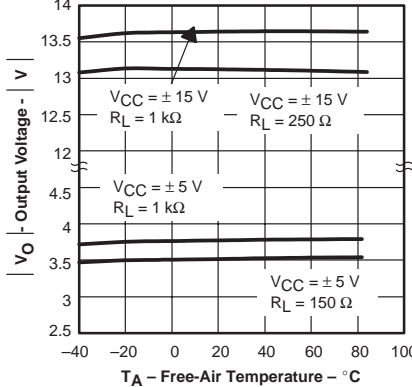

Figure 7

**SUPPLY CURRENT  
vs  
SUPPLY VOLTAGE**

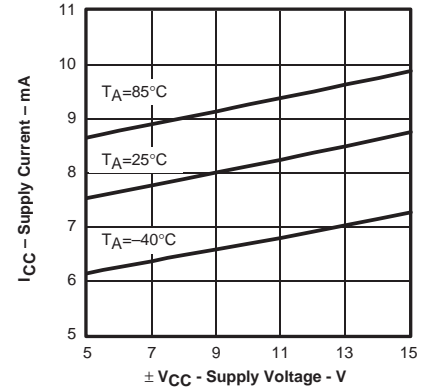

Figure 8

**VOLTAGE & CURRENT NOISE  
vs  
FREQUENCY**

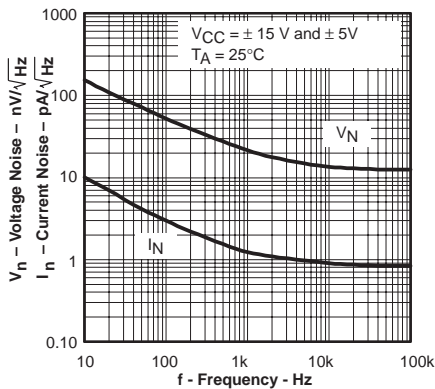

Figure 9

**POWER SUPPLY REJECTION  
RATIO  
vs  
FREQUENCY**

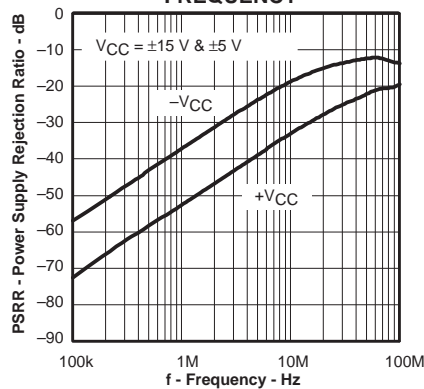

Figure 10

**CMRR  
vs  
FREQUENCY**

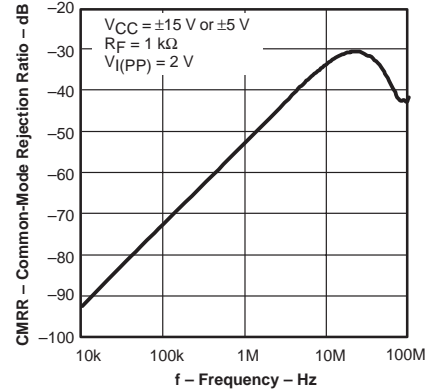

Figure 11

TYPICAL CHARACTERISTICS

CROSSTALK  
VS  
FREQUENCY

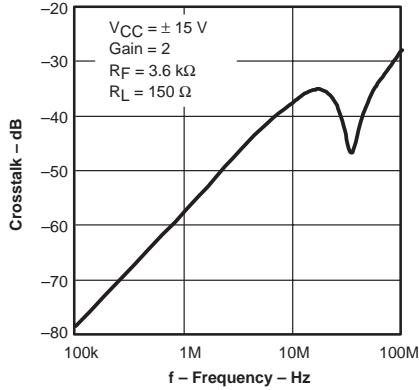

Figure 12

OPEN LOOP GAIN AND  
PHASE RESPONSE  
VS  
FREQUENCY

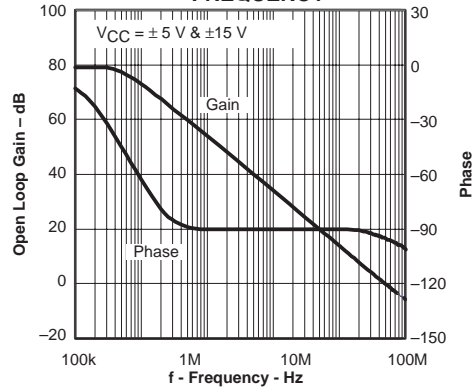

Figure 13

TOTAL HARMONIC DISTORTION  
VS  
FREQUENCY

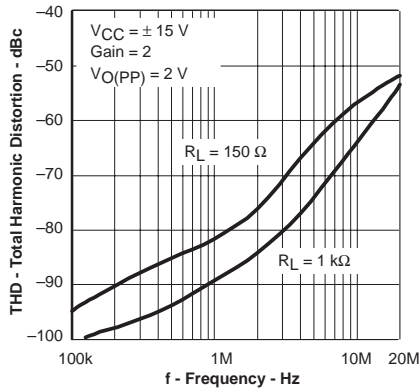

Figure 14

DISTORTION  
VS  
OUTPUT VOLTAGE

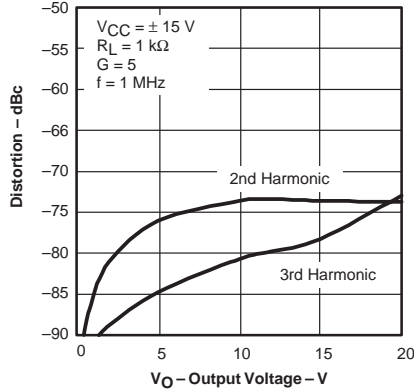

Figure 15

DISTORTION  
VS  
OUTPUT VOLTAGE

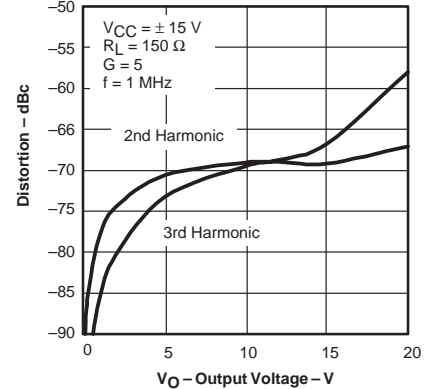

Figure 16

DISTORTION  
VS  
FREQUENCY

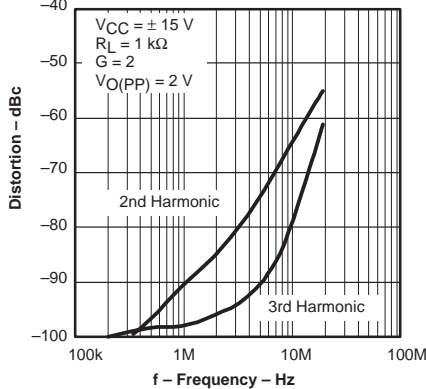

Figure 17

DISTORTION  
VS  
FREQUENCY

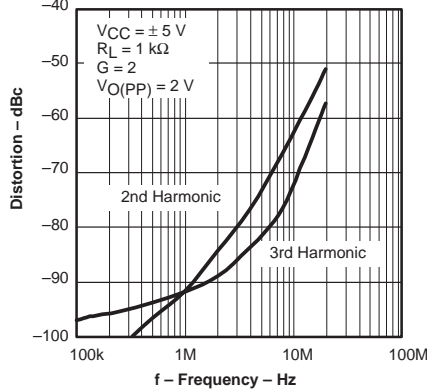

Figure 18

DISTORTION  
VS  
FREQUENCY

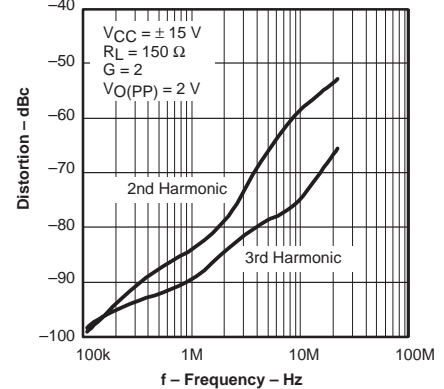

Figure 19

## TYPICAL CHARACTERISTICS

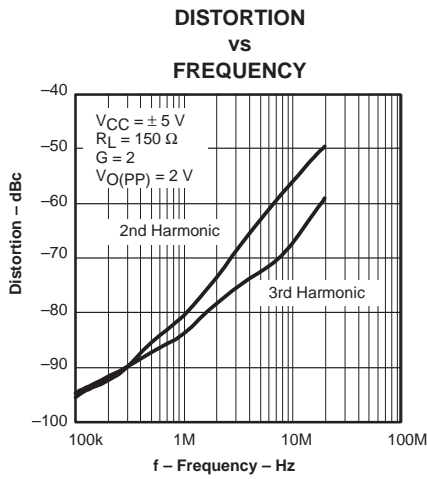

Figure 20

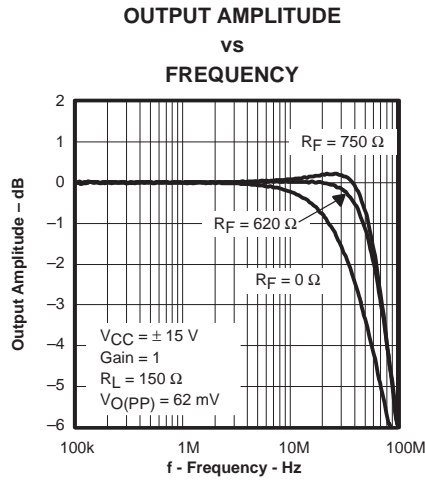

Figure 21

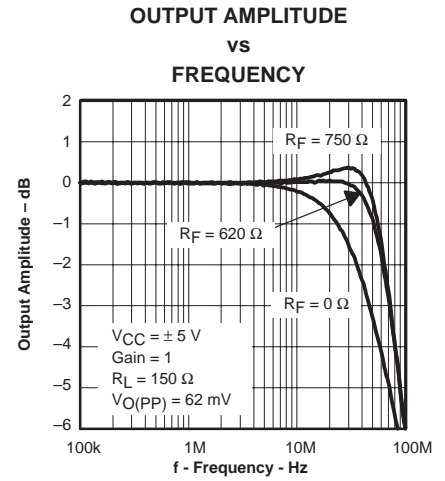

Figure 22

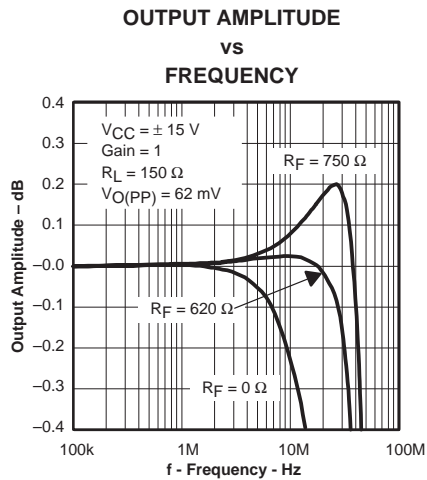

Figure 23

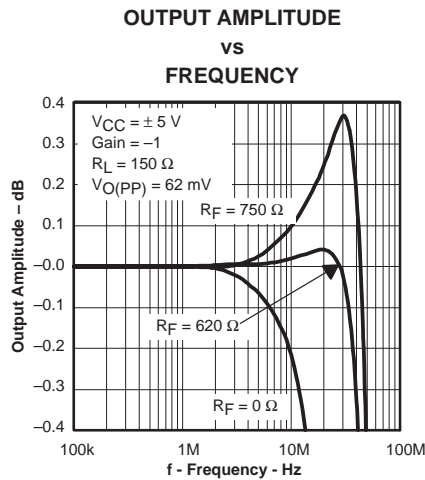

Figure 24

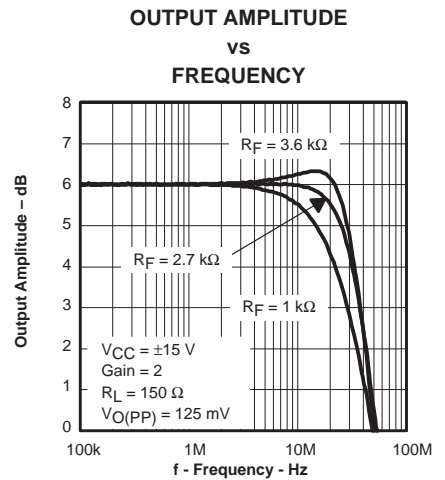

Figure 25

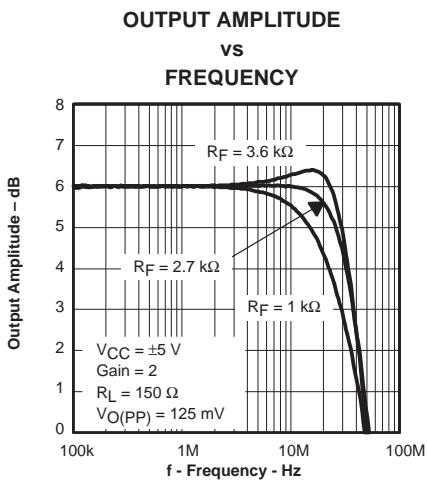

Figure 26

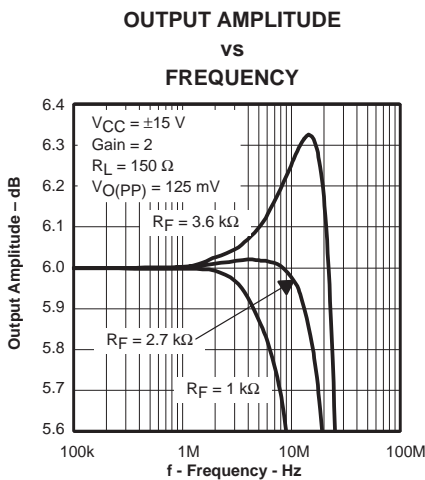

Figure 27

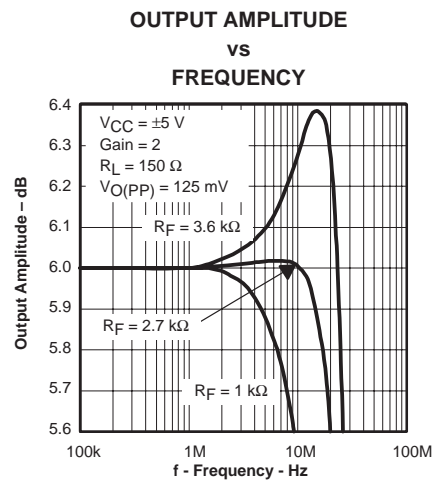
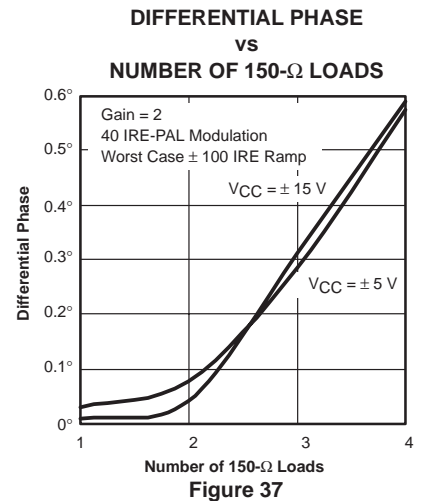
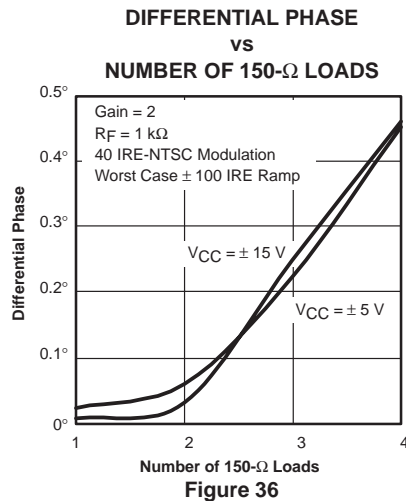
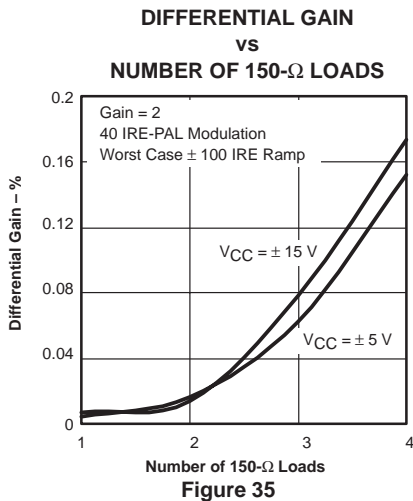
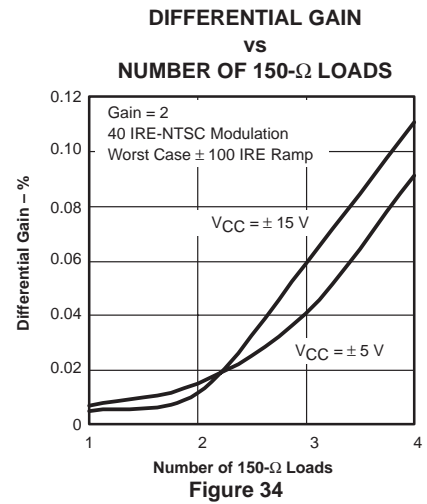
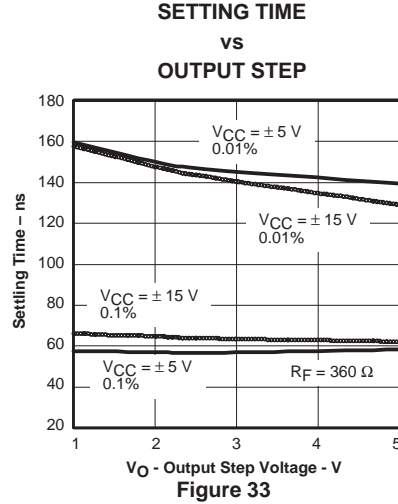
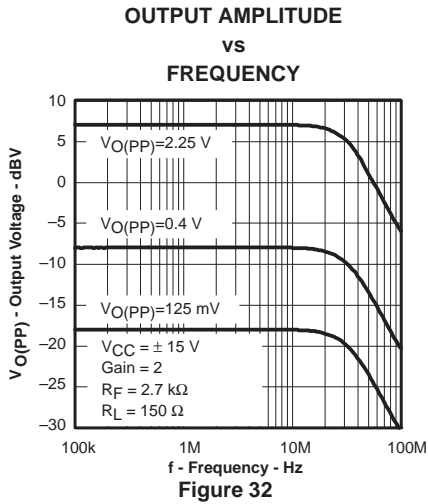
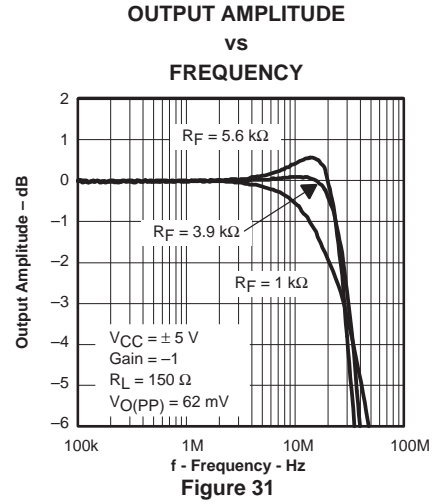
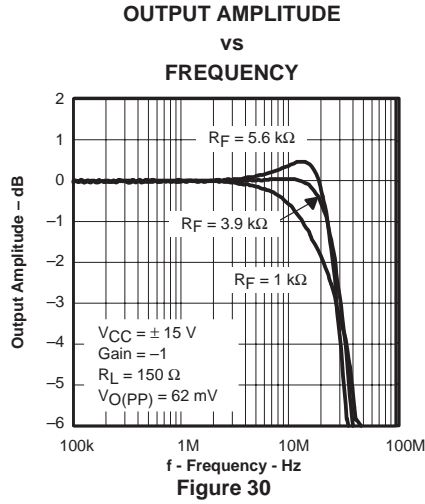
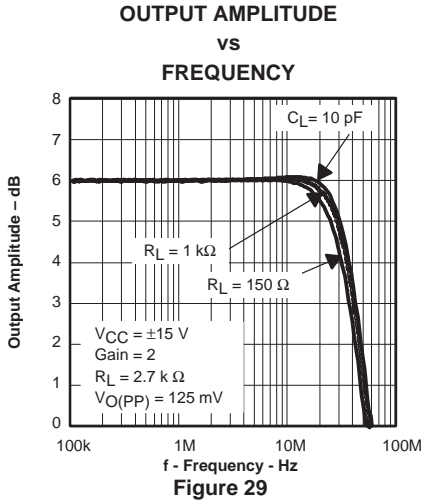

Figure 28

# THS4051, THS4052 70-MHz HIGH-SPEED AMPLIFIERS

SLOS238C—MAY 1999—REVISED MAY 2000

## TYPICAL CHARACTERISTICS



TYPICAL CHARACTERISTICS

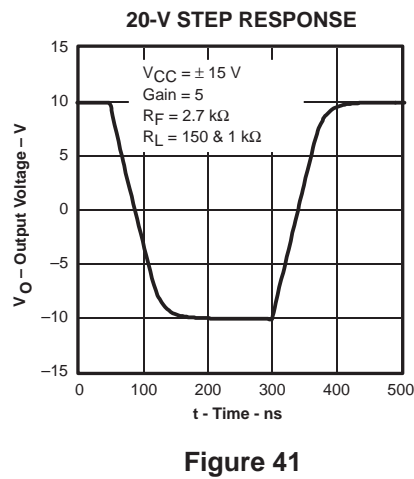
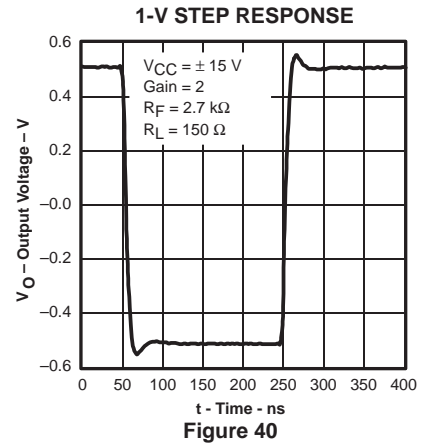
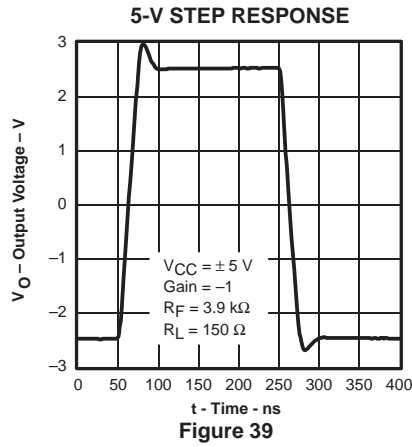
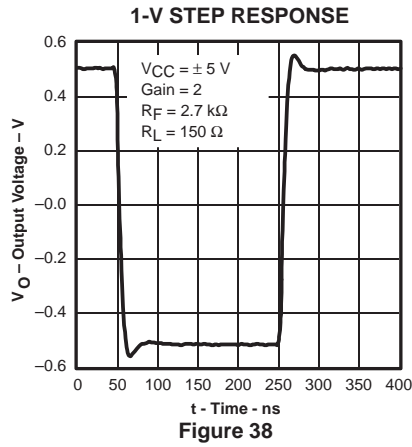

# THS4051, THS4052 70-MHz HIGH-SPEED AMPLIFIERS

SLOS238C—MAY 1999—REVISED MAY 2000

## APPLICATION INFORMATION

### theory of operation

The THS405x is a high-speed, operational amplifier configured in a voltage feedback architecture. It is built using a 30-V, dielectrically isolated, complementary bipolar process with NPN and PNP transistors possessing  $f_T$ s of several GHz. This results in an exceptionally high performance amplifier that has a wide bandwidth, high slew rate, fast settling time, and low distortion. A simplified schematic is shown in Figure 42.

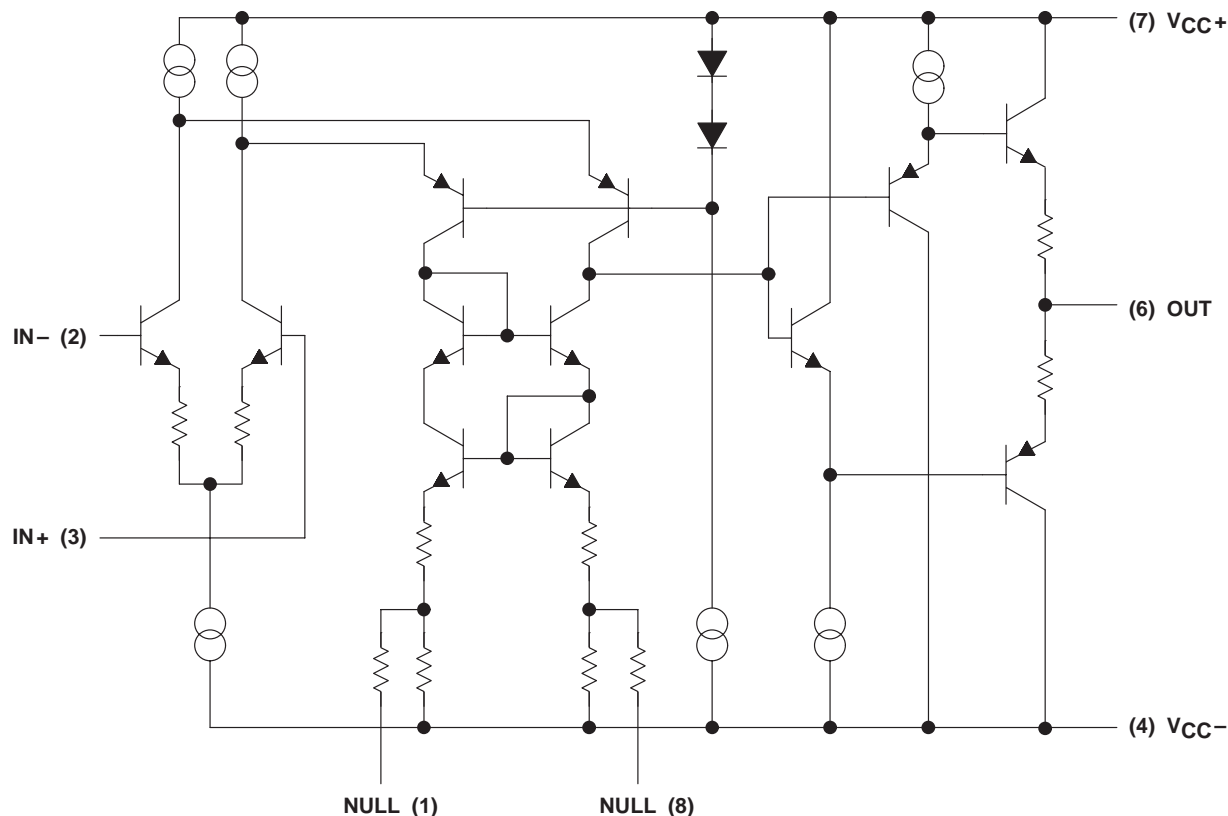

Figure 42. THS4051 Simplified Schematic

### noise calculations and noise figure

Noise can cause errors on very small signals. This is especially true when amplifying small signals, where signal-to-noise ratio (SNR) is very important. The noise model for the THS405x is shown in Figure 43. This model includes all of the noise sources as follows:

- $e_n$  = Amplifier internal voltage noise ( $nV/\sqrt{Hz}$ )
- $IN+$  = Noninverting current noise ( $pA/\sqrt{Hz}$ )
- $IN-$  = Inverting current noise ( $pA/\sqrt{Hz}$ )
- $e_{RX}$  = Thermal voltage noise associated with each resistor ( $e_{RX} = 4 kTR_X$ )

APPLICATION INFORMATION

noise calculations and noise figure (continued)

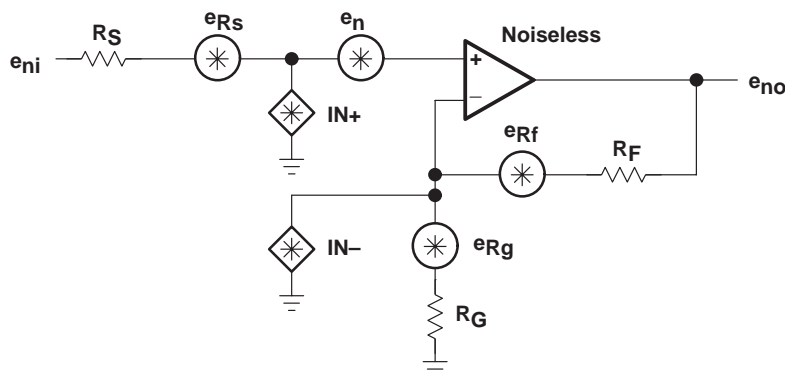

Figure 43. Noise Model

The total equivalent input noise density ( $e_{ni}$ ) is calculated by using the following equation:

$$e_{ni} = \sqrt{(e_n)^2 + (IN+ \times R_S)^2 + (IN- \times (R_F \parallel R_G))^2 + 4 kTR_S + 4 kT(R_F \parallel R_G)}$$

Where:

$k$  = Boltzmann's constant =  $1.380658 \times 10^{-23}$

$T$  = Temperature in degrees Kelvin ( $273 + ^\circ\text{C}$ )

$R_F \parallel R_G$  = Parallel resistance of  $R_F$  and  $R_G$

To get the equivalent output noise of the amplifier, just multiply the equivalent input noise density ( $e_{ni}$ ) by the overall amplifier gain ( $A_V$ ).

$$e_{no} = e_{ni} A_V = e_{ni} \left( 1 + \frac{R_F}{R_G} \right) \text{ (noninverting case)}$$

As the previous equations show, to keep noise at a minimum, small value resistors should be used. As the closed-loop gain is increased (by reducing  $R_G$ ), the input noise is reduced considerably because of the parallel resistance term. This leads to the general conclusion that the most dominant noise sources are the source resistor ( $R_S$ ) and the internal amplifier noise voltage ( $e_n$ ). Because noise is summed in a root-mean-squares method, noise sources smaller than 25% of the largest noise source can be effectively ignored. This can greatly simplify the formula and make noise calculations much easier to calculate.

For more information on noise analysis, please refer to the *Noise Analysis* section in *Operational Amplifier Circuits Applications Report* (literature number SLVA043).

APPLICATION INFORMATION

noise calculations and noise figure (continued)

This brings up another noise measurement usually preferred in RF applications, the noise figure (NF). Noise figure is a measure of noise degradation caused by the amplifier. The value of the source resistance must be defined and is typically 50 Ω in RF applications.

$$NF = 10\log \left[ \frac{e_{ni}^2}{(e_{Rs})^2} \right]$$

Because the dominant noise components are generally the source resistance and the internal amplifier noise voltage, we can approximate noise figure as:

$$NF = 10\log \left[ 1 + \frac{\left( (e_n)^2 + (IN + \times R_S)^2 \right)}{4 kTR_S} \right]$$

Figure 44 shows the noise figure graph for the THS405x.

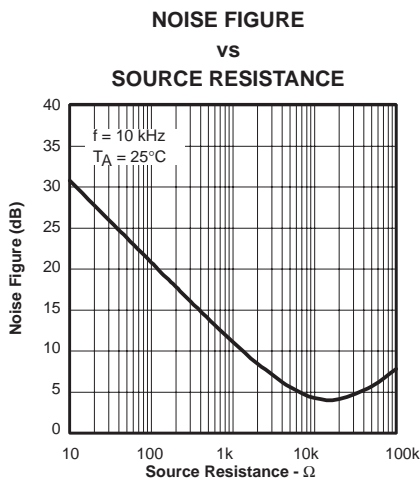

Figure 44. Noise Figure vs Source Resistance



APPLICATION INFORMATION

driving a capacitive load

Driving capacitive loads with high performance amplifiers is not a problem as long as certain precautions are taken. The first is to realize that the THS405x has been internally compensated to maximize its bandwidth and slew rate performance. When the amplifier is compensated in this manner, capacitive loading directly on the output will decrease the device's phase margin leading to high frequency ringing or oscillations. Therefore, for capacitive loads of greater than 10 pF, it is recommended that a resistor be placed in series with the output of the amplifier, as shown in Figure 45. A minimum value of 20 Ω should work well for most applications. For example, in 75-Ω transmission systems, setting the series resistor value to 75 Ω both isolates any capacitance loading and provides the proper line impedance matching at the source end.

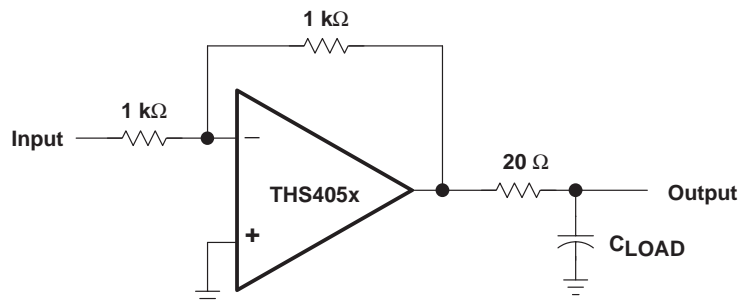

Figure 45. Driving a Capacitive Load

offset nulling

The THS405x has very low input offset voltage for a high-speed amplifier. However, if additional correction is required, an offset nulling function has been provided on the THS4051. The input offset can be adjusted by placing a potentiometer between terminals 1 and 8 of the device and tying the wiper to the negative supply. This is shown in Figure 46.

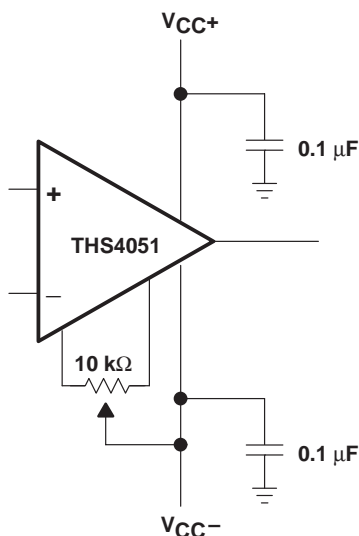
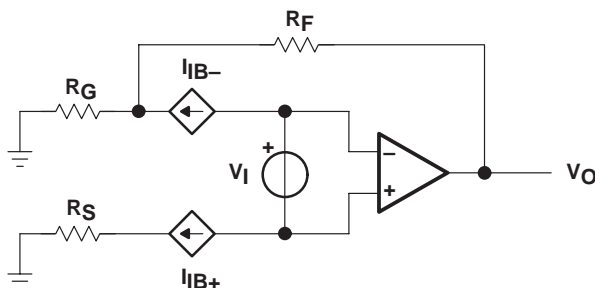

Figure 46. Offset Nulling Schematic

APPLICATION INFORMATION

offset voltage

The output offset voltage, ( $V_{OO}$ ) is the sum of the input offset voltage ( $V_{IO}$ ) and both input bias currents ( $I_{IB}$ ) times the corresponding gains. The following schematic and formula can be used to calculate the output offset voltage:



$$V_{OO} = V_{IO} \left( 1 + \left( \frac{R_F}{R_G} \right) \right) \pm I_{IB+} R_S \left( 1 + \left( \frac{R_F}{R_G} \right) \right) \pm I_{IB-} R_F$$

Figure 47. Output Offset Voltage Model

optimizing unity gain response

Internal frequency compensation of the THS405x was selected to provide very wideband performance yet still maintain stability when operated in a noninverting unity gain configuration. When amplifiers are compensated in this manner there is usually peaking in the closed loop response and some ringing in the step response for very fast input edges, depending upon the application. This is because a minimum phase margin is maintained for the  $G=+1$  configuration. For optimum settling time and minimum ringing, a feedback resistor of  $620 \Omega$  should be used as shown in Figure 48. Additional capacitance can also be used in parallel with the feedback resistance if even finer optimization is required.

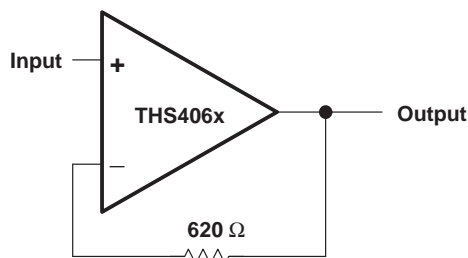

Figure 48. Noninverting, Unity Gain Schematic

APPLICATION INFORMATION

general configurations

When receiving low-level signals, limiting the bandwidth of the incoming signals into the system is often required. The simplest way to accomplish this is to place an RC filter at the noninverting terminal of the amplifier (see Figure 49).

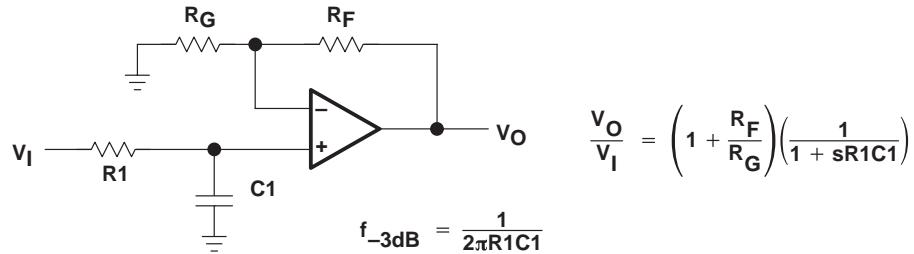

Figure 49. Single-Pole Low-Pass Filter

If even more attenuation is needed, a multiple pole filter is required. The Sallen-Key filter can be used for this task. For best results, the amplifier should have a bandwidth that is 8 to 10 times the filter frequency bandwidth. Failure to do this can result in phase shift of the amplifier.

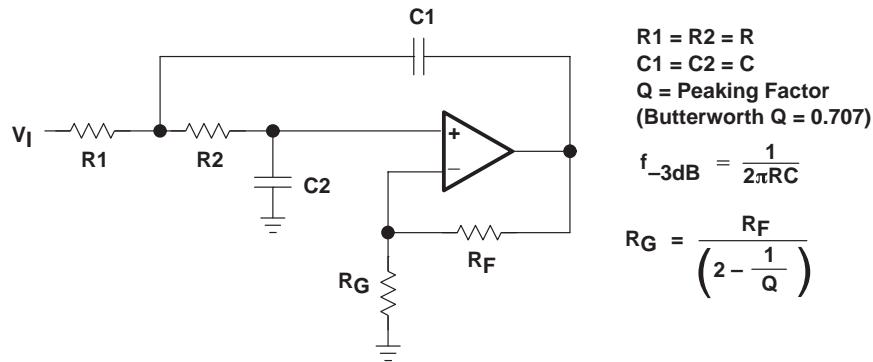

Figure 50. 2-Pole Low-Pass Sallen-Key Filter

## APPLICATION INFORMATION

### circuit layout considerations

To achieve the levels of high frequency performance of the THS405x, follow proper printed-circuit board high frequency design techniques. A general set of guidelines is given below. In addition, a THS405x evaluation board is available to use as a guide for layout or for evaluating the device performance.

- Ground planes – It is highly recommended that a ground plane be used on the board to provide all components with a low inductive ground connection. However, in the areas of the amplifier inputs and output, the ground plane can be removed to minimize the stray capacitance.
- Proper power supply decoupling – Use a 6.8- $\mu$ F tantalum capacitor in parallel with a 0.1- $\mu$ F ceramic capacitor on each supply terminal. It may be possible to share the tantalum among several amplifiers depending on the application, but a 0.1- $\mu$ F ceramic capacitor should always be used on the supply terminal of every amplifier. In addition, the 0.1- $\mu$ F capacitor should be placed as close as possible to the supply terminal. As this distance increases, the inductance in the connecting trace makes the capacitor less effective. The designer should strive for distances of less than 0.1 inches between the device power terminals and the ceramic capacitors.
- Sockets – Sockets are not recommended for high-speed operational amplifiers. The additional lead inductance in the socket pins will often lead to stability problems. Surface-mount packages soldered directly to the printed-circuit board is the best implementation.
- Short trace runs/compact part placements – Optimum high frequency performance is achieved when stray series inductance has been minimized. To realize this, the circuit layout should be made as compact as possible, thereby minimizing the length of all trace runs. Particular attention should be paid to the inverting input of the amplifier. Its length should be kept as short as possible. This will help to minimize stray capacitance at the input of the amplifier.
- Surface-mount passive components – Using surface-mount passive components is recommended for high frequency amplifier circuits for several reasons. First, because of the extremely low lead inductance of surface-mount components, the problem with stray series inductance is greatly reduced. Second, the small size of surface-mount components naturally leads to a more compact layout thereby minimizing both stray inductance and capacitance. If leaded components are used, it is recommended that the lead lengths be kept as short as possible.

### general PowerPAD™ design considerations

The THS405x is available packaged in a thermally-enhanced DGN package, which is a member of the PowerPAD™ family of packages. This package is constructed using a downset leadframe upon which the die is mounted [see Figure 51(a) and Figure 51(b)]. This arrangement results in the lead frame being exposed as a thermal pad on the underside of the package [see Figure 51(c)]. Because this thermal pad has direct thermal contact with the die, excellent thermal performance can be achieved by providing a good thermal path away from the thermal pad.

The PowerPAD™ package allows for both assembly and thermal management in one manufacturing operation. During the surface-mount solder operation (when the leads are being soldered), the thermal pad can also be soldered to a copper area underneath the package. Through the use of thermal paths within this copper area, heat can be conducted away from the package into either a ground plane or other heat dissipating device.

The PowerPAD™ package represents a breakthrough in combining the small area and ease of assembly of the surface mount with the, heretofore, awkward mechanical methods of heatsinking.

APPLICATION INFORMATION

general PowerPAD™ design considerations (continued)

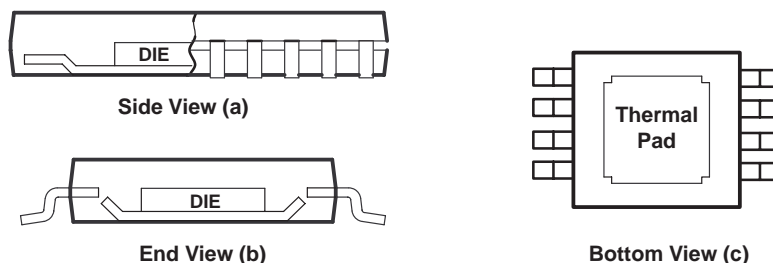

NOTE A: The thermal pad is electrically isolated from all terminals in the package.

Figure 51. Views of Thermally Enhanced DGN Package

Although there are many ways to properly heatsink this device, the following steps illustrate the recommended approach.

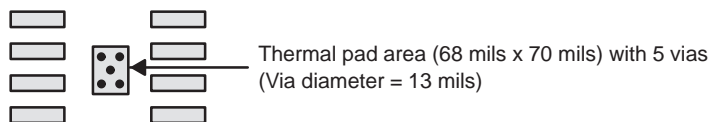

Figure 52. PowerPAD™ PCB Etch and Via Pattern

1. Prepare the PCB with a top side etch pattern as shown in Figure 52. There should be etch for the leads as well as etch for the thermal pad.
2. Place five holes in the area of the thermal pad. These holes should be 13 mils in diameter. Keep them small so that solder wicking through the holes is not a problem during reflow.
3. Additional vias may be placed anywhere along the thermal plane outside of the thermal pad area. This helps dissipate the heat generated by the THS405xDGN IC. These additional vias may be larger than the 13-mil diameter vias directly under the thermal pad. They can be larger because they are not in the thermal pad area to be soldered so that wicking is not a problem.
4. Connect all holes to the internal ground plane.
5. When connecting these holes to the ground plane, *do not* use the typical web or spoke via connection methodology. Web connections have a high thermal resistance connection that is useful for slowing the heat transfer during soldering operations. This makes the soldering of vias that have plane connections easier. In this application, however, low thermal resistance is desired for the most efficient heat transfer. Therefore, the holes under the THS405xDGN package should make their connection to the internal ground plane with a complete connection around the entire circumference of the plated-through hole.
6. The top-side solder mask should leave the terminals of the package and the thermal pad area with its five holes exposed. The bottom-side solder mask should cover the five holes of the thermal pad area. This prevents solder from being pulled away from the thermal pad area during the reflow process.
7. Apply solder paste to the exposed thermal pad area and all of the IC terminals.
8. With these preparatory steps in place, the THS405xDGN IC is simply placed in position and run through the solder reflow operation as any standard surface-mount component. This results in a part that is properly installed.

**APPLICATION INFORMATION**

**general PowerPAD™ design considerations (continued)**

The actual thermal performance achieved with the THS405xDGN in its PowerPAD™ package depends on the application. In the example above, if the size of the internal ground plane is approximately 3 inches × 3 inches, then the expected thermal coefficient,  $\theta_{JA}$ , is about 58.4°C/W. For comparison, the non-PowerPAD™ version of the THS405x IC (SOIC) is shown. For a given  $\theta_{JA}$ , the maximum power dissipation is shown in Figure 53 and is calculated by the following formula:

$$P_D = \left( \frac{T_{MAX} - T_A}{\theta_{JA}} \right)$$

Where:

- $P_D$  = Maximum power dissipation of THS405x IC (watts)
- $T_{MAX}$  = Absolute maximum junction temperature (150°C)
- $T_A$  = Free-ambient air temperature (°C)
- $\theta_{JA}$  =  $\theta_{JC} + \theta_{CA}$
- $\theta_{JC}$  = Thermal coefficient from junction to case
- $\theta_{CA}$  = Thermal coefficient from case to ambient air (°C/W)

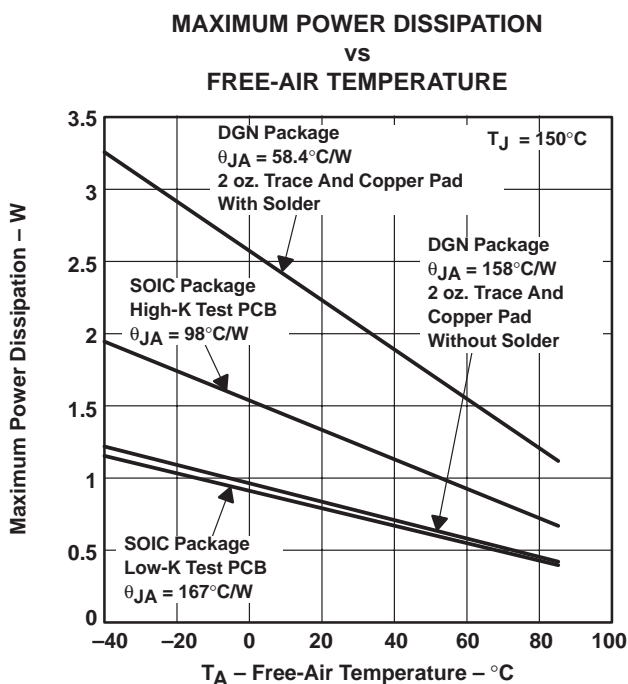

NOTE A: Results are with no air flow and PCB size = 3"× 3"

**Figure 53. Maximum Power Dissipation vs Free-Air Temperature**

More complete details of the PowerPAD™ installation process and thermal management techniques can be found in the Texas Instruments Technical Brief, *PowerPAD™ Thermally Enhanced Package*. This document can be found at the TI web site ([www.ti.com](http://www.ti.com)) by searching on the key word PowerPAD™. The document can also be ordered through your local TI sales office. Refer to literature number SLMA002 when ordering.

APPLICATION INFORMATION

general PowerPAD™ design considerations (continued)

The next consideration is the package constraints. The two sources of heat within an amplifier are quiescent power and output power. The designer should never forget about the quiescent heat generated within the device, especially devices with multiple amplifiers. Because these devices have linear output stages (Class A-B), most of the heat dissipation is at low output voltages with high output currents. Figure 54 to Figure 57 show this effect, along with the quiescent heat, with an ambient air temperature of 50°C. Obviously, as the ambient temperature increases, the limit lines shown will drop accordingly. The area under each respective limit line is considered the safe operating area. Any condition above this line will exceed the amplifier's limits and failure may result. When using  $V_{CC} = \pm 5\text{ V}$ , there is generally not a heat problem, even with SOIC packages. But, when using  $V_{CC} = \pm 15\text{ V}$ , the SOIC package is severely limited in the amount of heat it can dissipate. The other key factor when looking at these graphs is how the devices are mounted on the PCB. The PowerPAD™ devices are extremely useful for heat dissipation. But, the device should always be soldered to a copper plane to fully use the heat dissipation properties of the PowerPAD™. The SOIC package, on the other hand, is highly dependent on how it is mounted on the PCB. As more trace and copper area is placed around the device,  $\theta_{JA}$  decreases and the heat dissipation capability increases. The currents and voltages shown in these graphs are for the total package. For the dual amplifier package (THS4052), the sum of the RMS output currents and voltages should be used to choose the proper package. The graphs shown assume that both amplifier's outputs are identical.

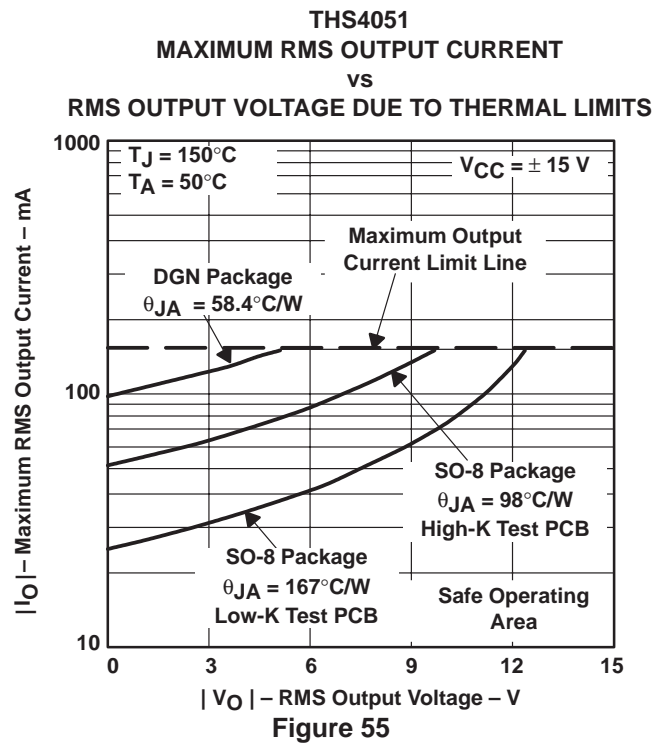
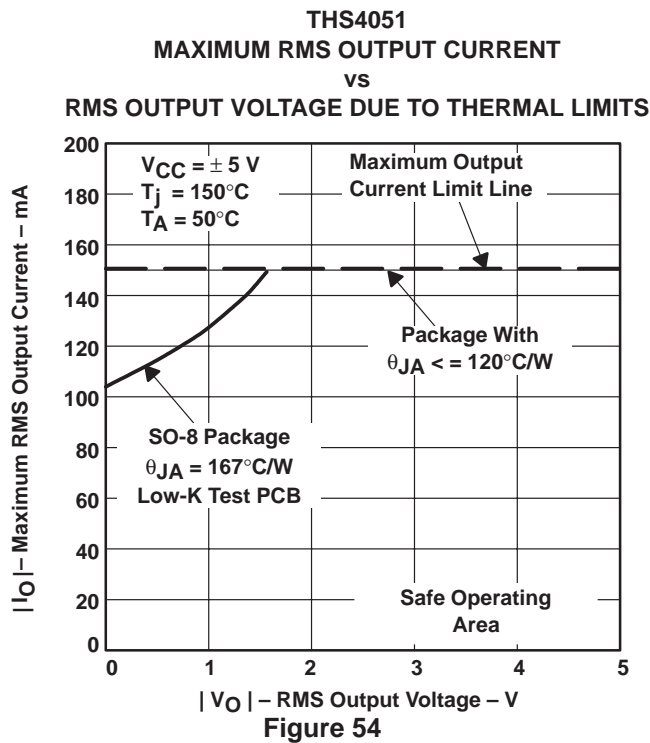

# THS4051, THS4052 70-MHz HIGH-SPEED AMPLIFIERS

SLOS238C—MAY 1999—REVISED MAY 2000

## APPLICATION INFORMATION

### general PowerPAD™ design considerations (continued)

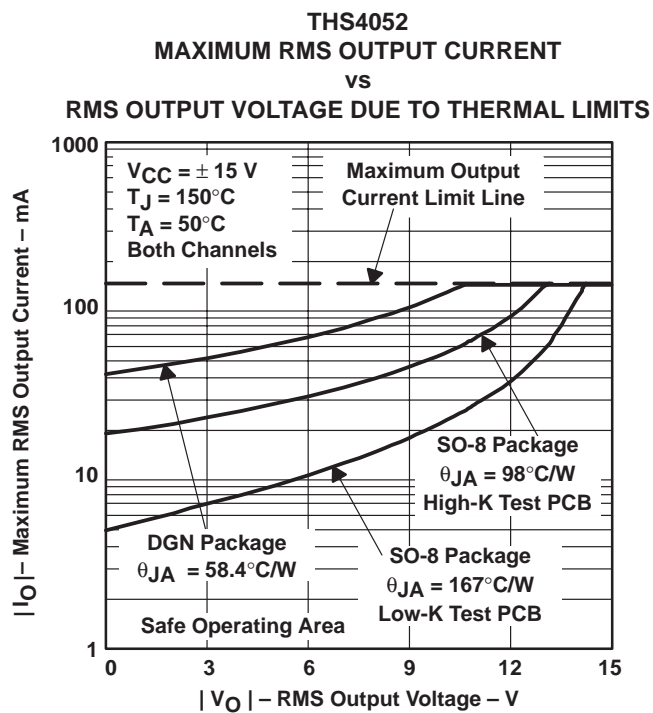
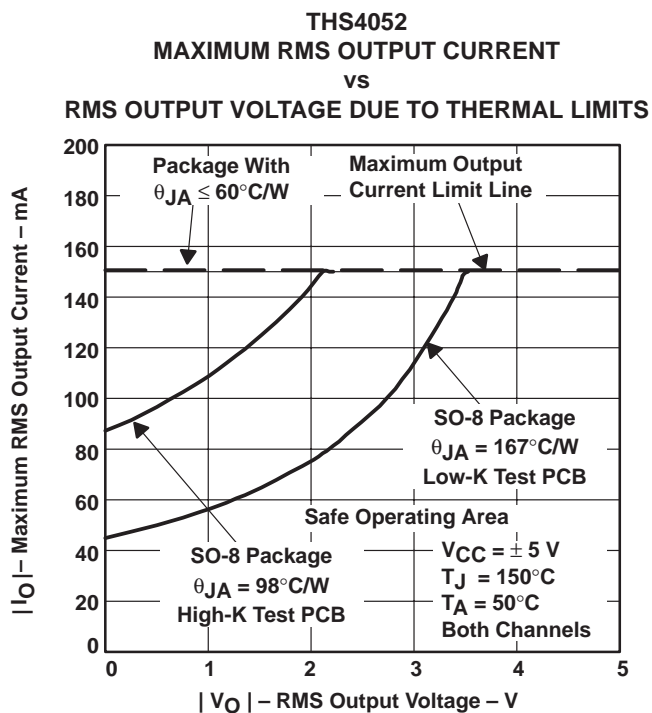



APPLICATION INFORMATION

evaluation board

An evaluation board is available for the THS4051 (literature number SLOP220) and THS4052 (literature number SLOP234). This board has been configured for very low parasitic capacitance in order to realize the full performance of the amplifier. A schematic of the evaluation board is shown in Figure 58. The circuitry has been designed so that the amplifier may be used in either an inverting or noninverting configuration. For more information, please refer to the *THS4051 EVM User's Guide* or the *THS4052 EVM User's Guide*. To order the evaluation board, contact your local TI sales office or distributor.

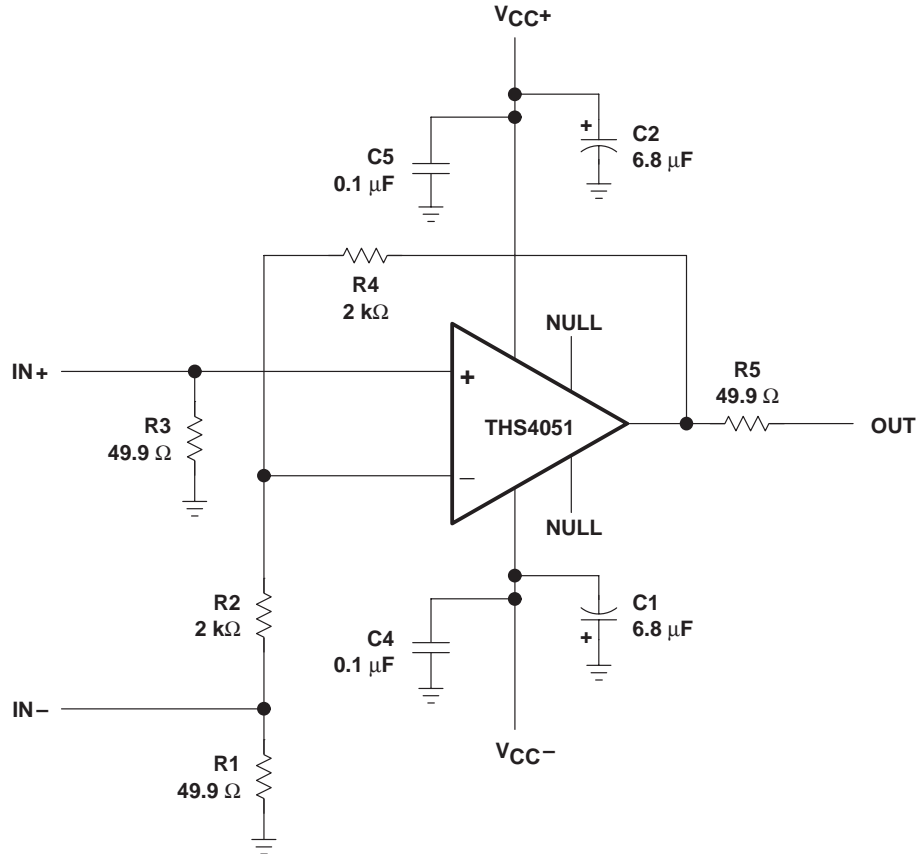

Figure 58. THS4051 Evaluation Board

# THS4051, THS4052 70-MHz HIGH-SPEED AMPLIFIERS

SLOS238C—MAY 1999 — REVISED MAY 2000

## MECHANICAL INFORMATION

D (R-PDSO-G\*\*)

PLASTIC SMALL-OUTLINE PACKAGE

14 PIN SHOWN

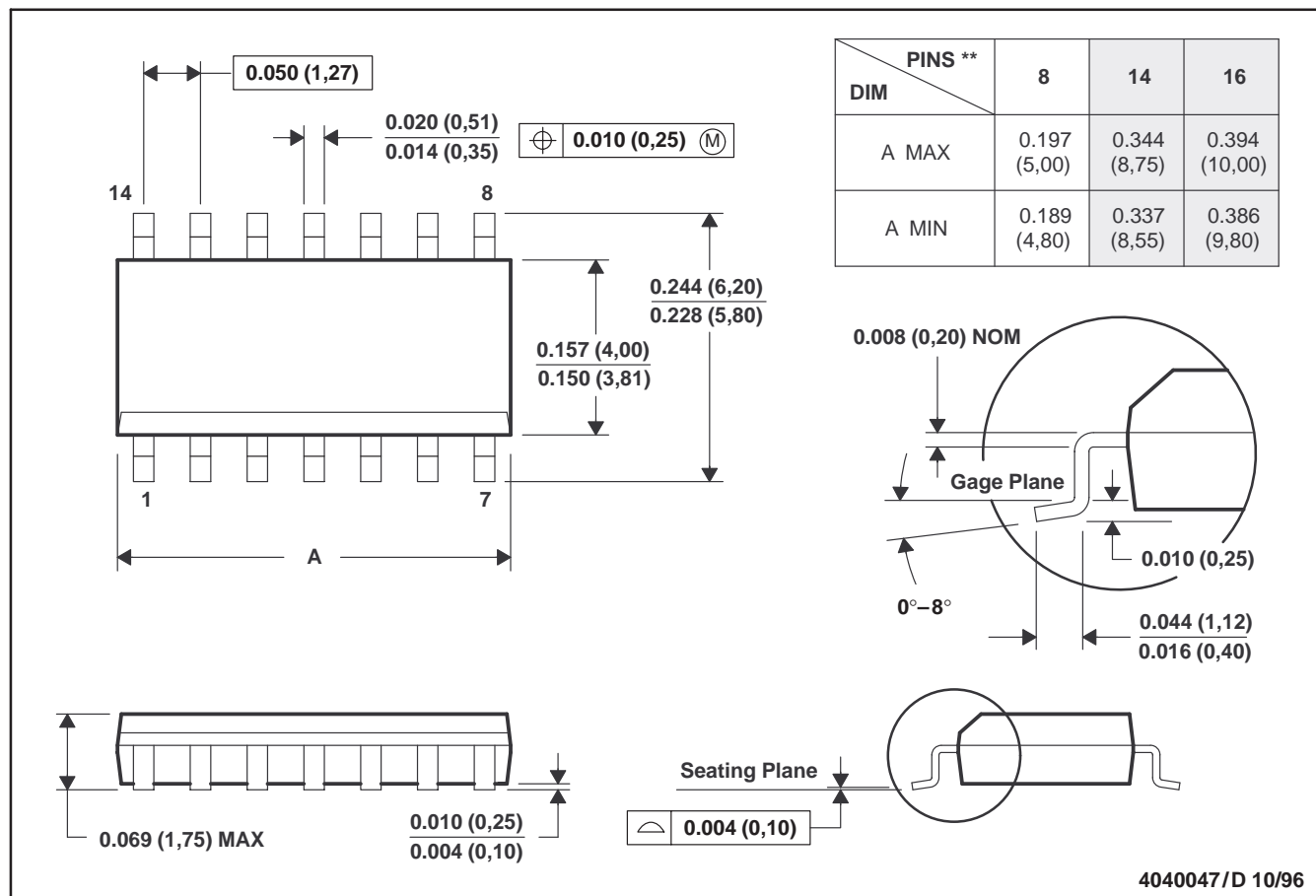

- NOTES: A. All linear dimensions are in inches (millimeters).  
 B. This drawing is subject to change without notice.  
 C. Body dimensions do not include mold flash or protrusion, not to exceed 0.006 (0,15).  
 D. Falls within JEDEC MS-012

MECHANICAL INFORMATION

DGN (S-PDSO-G8)

PowerPAD™ PLASTIC SMALL-OUTLINE PACKAGE

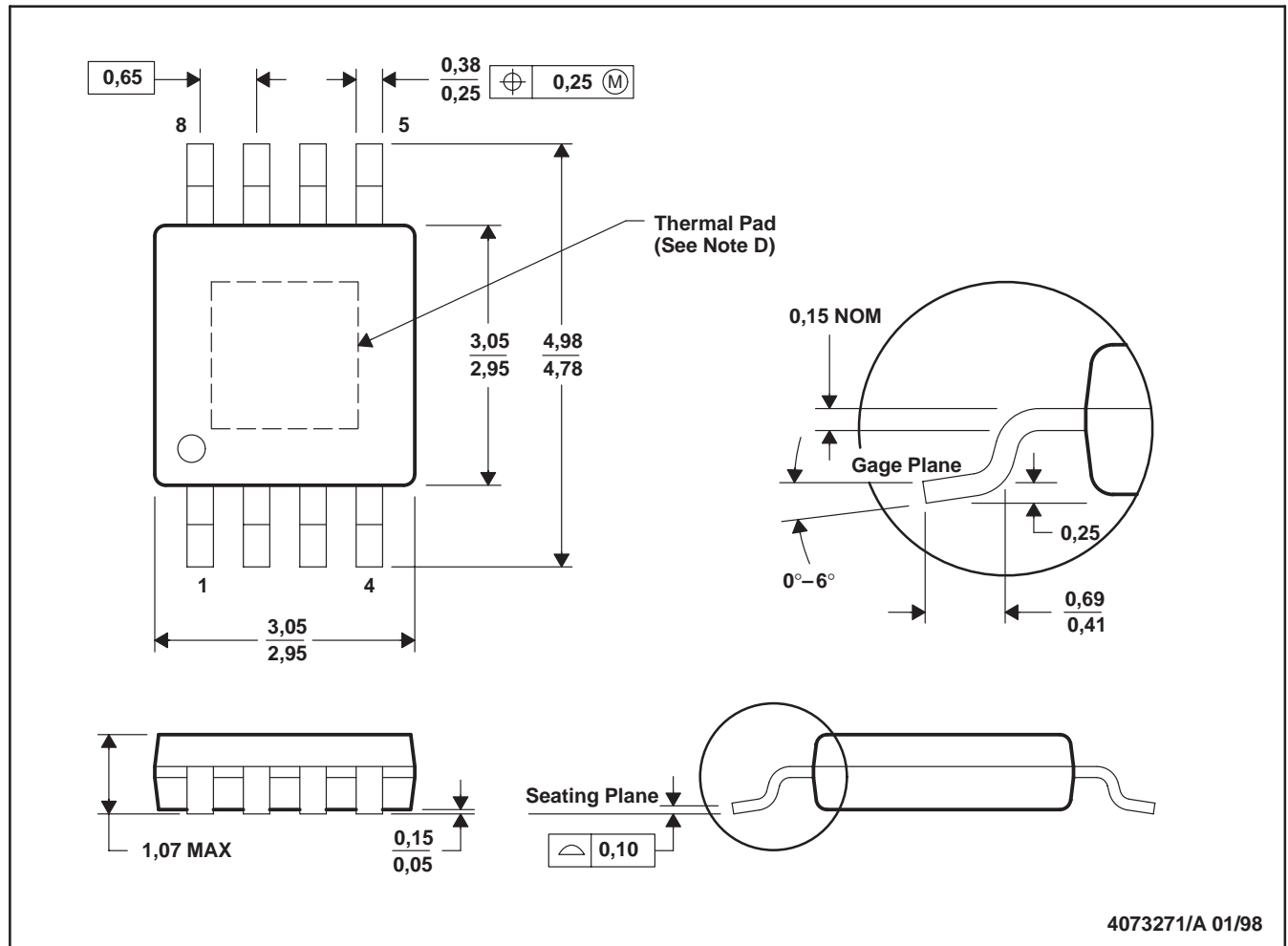

- NOTES: A. All linear dimensions are in millimeters.  
 B. This drawing is subject to change without notice.  
 C. Body dimensions include mold flash or protrusions.  
 D. The package thermal performance may be enhanced by attaching an external heat sink to the thermal pad. This pad is electrically and thermally connected to the backside of the die and possibly selected leads.  
 E. Falls within JEDEC MO-187

PowerPAD is a trademark of Texas Instruments.



MECHANICAL INFORMATION

JG (R-GDIP-T8)

CERAMIC DUAL-IN-LINE PACKAGE

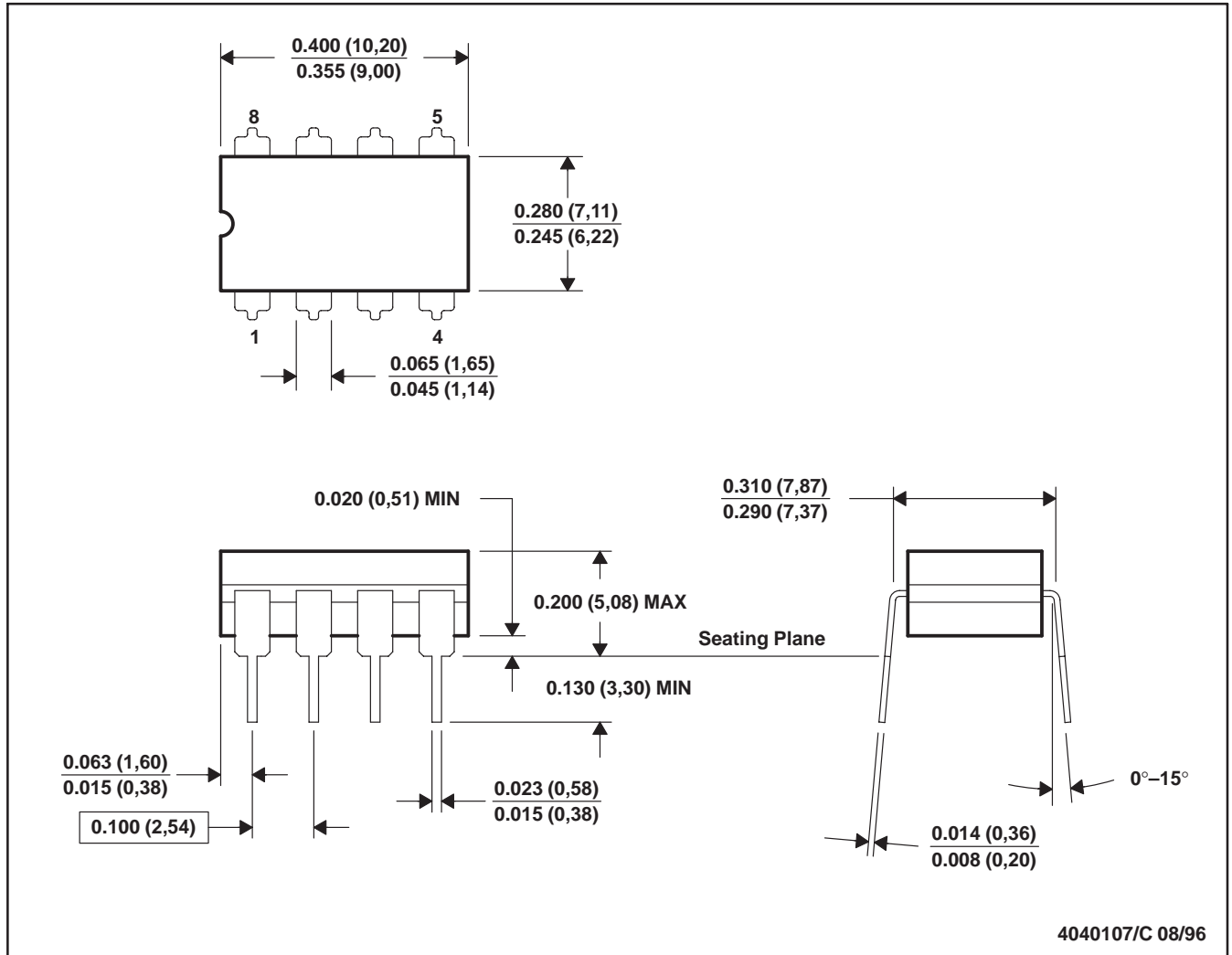

- NOTES: A. All linear dimensions are in inches (millimeters).  
 B. This drawing is subject to change without notice.  
 C. This package can be hermetically sealed with a ceramic lid using glass frit.  
 D. Index point is provided on cap for terminal identification only on press ceramic glass frit seal only.  
 E. Falls within MIL-STD-1835 GDIP1-T8

## **IMPORTANT NOTICE**

Texas Instruments and its subsidiaries (TI) reserve the right to make changes to their products or to discontinue any product or service without notice, and advise customers to obtain the latest version of relevant information to verify, before placing orders, that information being relied on is current and complete. All products are sold subject to the terms and conditions of sale supplied at the time of order acknowledgment, including those pertaining to warranty, patent infringement, and limitation of liability.

TI warrants performance of its semiconductor products to the specifications applicable at the time of sale in accordance with TI's standard warranty. Testing and other quality control techniques are utilized to the extent TI deems necessary to support this warranty. Specific testing of all parameters of each device is not necessarily performed, except those mandated by government requirements.

Customers are responsible for their applications using TI components.

In order to minimize risks associated with the customer's applications, adequate design and operating safeguards must be provided by the customer to minimize inherent or procedural hazards.

TI assumes no liability for applications assistance or customer product design. TI does not warrant or represent that any license, either express or implied, is granted under any patent right, copyright, mask work right, or other intellectual property right of TI covering or relating to any combination, machine, or process in which such semiconductor products or services might be or are used. TI's publication of information regarding any third party's products or services does not constitute TI's approval, warranty or endorsement thereof.

Copyright © Each Manufacturing Company.

All Datasheets cannot be modified without permission.

This datasheet has been download from :

[www.AllDataSheet.com](http://www.AllDataSheet.com)

100% Free DataSheet Search Site.

Free Download.

No Register.

Fast Search System.

[www.AllDataSheet.com](http://www.AllDataSheet.com)