



查询TIL300供应商

TAOS

TEXAS
ADVANCED
OPTOELECTRONIC
SOLUTIONS™

捷多邦, 专业PCB打样工厂, 24小时加急出货

TIL300, TIL300A PRECISION LINEAR OPTOCOUPLER

TAOS018 – AUGUST 1999

- ac or dc Signal Coupling
- Wide Bandwidth . . . >200 kHz
- High Transfer-Gain Stability . . . $\pm 0.005\%/^{\circ}\text{C}$
- 3500 V Peak Isolation
- Typical Applications
 - Power-Supply Feedback
 - Medical-Sensor Isolation
 - Opto Direct-Access Arrangement (DAA)
 - Isolated Process-Control Transducers

DCS OR P PACKAGE (TOP VIEW)

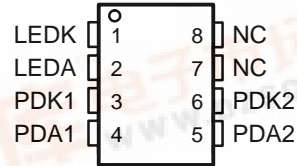

NC – No internal connection

Description

The TIL300 precision linear optocoupler consists of an infrared LED irradiating an isolated feedback photodiode and an output photodiode in a bifurcated arrangement. The feedback photodiode captures a percentage of the flux of the LED that can be used to generate a control signal to regulate the LED drive current. This technique is used to compensate for the nonlinear time and temperature characteristics of the LED. The output-side photodiode then produces an output signal that is linearly proportional to the servo-optical flux emitted from the LED.

A typical application circuit (shown in Figure 1) uses an operational amplifier as the input to drive the LED. The feedback photodiode sources current through R1, which is connected to the inverting input of the input operational amplifier. The photocurrent I_{P1} assumes a magnitude that satisfies the relationship $I_{P1} = V_i/R1$. The magnitude of the current is directly proportional to the LED current through the feedback transfer gain $K1$ ($V_i/R1 = K1 \times I_F$). The operational amplifier supplies LED current to produce sufficient photocurrent to keep the node voltage V_b equal to node voltage V_a .

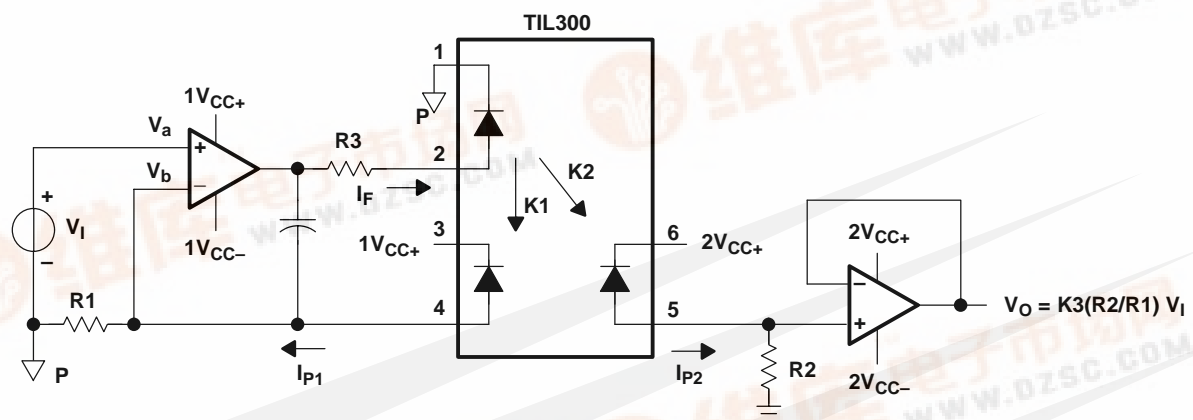

- NOTES:
- A. $K1$ is servo current gain, the ratio of the feedback servo photodiode current (I_{P1}) to the input LED current (I_F), i.e. $K1 = I_{P1}/I_F$.
 - B. $K2$ is forward gain, the ratio of the output photodiode current (I_{P2}) to the input LED current (I_F), i.e. $K2 = I_{P2}/I_F$.
 - C. $K3$ is transfer gain, the ratio of the forward gain to the servo gain, i.e. $K3 = K2/K1$.

Figure 1. Typical Application Circuit

The output photodiode is connected to a noninverting voltage follower; R2 is used to develop a voltage from the photodiode current. The output of the amplifier is $V_O = K2I_FR2$. Overall transfer gain V_O/V_i becomes $V_O/V_i = (K2I_FR2/K1I_FR1)$. Factoring out the LED forward current I_F and remembering that $K2/K1 = K3$, the overall transfer gain becomes $V_O/V_i = K3R2/R1$. The overall transfer gain, therefore, is shown to be independent of the LED current.

TIL300, TIL300A PRECISION LINEAR OPTOCOUPLER

TAOS018 – AUGUST 1999

Terminal Functions

TERMINAL		DESCRIPTION
NAME	NO.	
LEDK	1	LED cathode
LEDA	2	LED anode
PDK1	3	Photodiode 1 cathode
PDA1	4	Photodiode 1 anode
PDA2	5	Photodiode 2 anode
PDK2	6	Photodiode 2 cathode
NC	7	No internal connection
NC	8	No internal connection

Absolute Maximum Ratings over operating free-air temperature range (unless otherwise noted)[†]

Emitter

Continuous total power dissipation (see Note 1)	160 mW
Input LED forward current, I_F	60 mA
Surge current with pulse duration < 10 μ s	250 mA
Reverse voltage, V_R	5 V
Reverse current, I_R	10 μ A

Detector

Continuous total power dissipation (see Note 2)	50 mW
Reverse voltage, V_R	50 V

Coupler

Continuous total power dissipation (see Note 3)	210 mW
Storage temperature range, T_{stg}	-55°C to 150°C
Operating free-air temperature range, T_A	-55°C to 100°C
Input-to-output voltage	3535 V _{peak}
Lead temperature 1,6 mm (1/16 inch) from case for 10 seconds	260°C

[†] Stresses beyond those listed under "absolute maximum ratings" may cause permanent damage to the device. These are stress ratings only, and functional operation of the device at these conditions is not implied. Exposure to absolute-maximum-rated conditions for extended periods may affect device reliability.

- NOTES:
1. Derate linearly from 25°C at a rate of 2.66 mW/°C.
 2. Derate linearly from 25°C at a rate of 0.66 mW/°C.
 3. Derate linearly from 25°C at a rate of 3.33 mW/°C.

TIL300, TIL300A PRECISION LINEAR OPTOCOUPLER

TAOS018 – AUGUST 1999

Electrical Characteristics at $T_A = 25^\circ\text{C}$ (unless otherwise noted)

Emitter

PARAMETER		TEST CONDITIONS	MIN	TYP	MAX	UNIT
V_F	LED forward voltage	$I_F = 10\text{ mA}$	1.25	1.50		V
	Temperature coefficient of V_F		-2.2			mV/°C
I_R	Reverse current	$V_R = 5\text{ V}$			10	μA
t_r	Rise time	$I_F = 10\text{ mA}$, $\Delta I_F = 2\text{ mA}$		1		μs
t_f	Fall time	$I_F = 10\text{ mA}$, $\Delta I_F = 2\text{ mA}$		1		μs
C_j	Junction capacitance	$V_F = 0$, $f = 1\text{ MHz}$		15		pF

Detector

PARAMETER		TEST CONDITIONS	MIN	TYP	MAX	UNIT
I_{DK}^\dagger	Dark current	$V_R = -15\text{ V}$, $I_F = 0$			25	nA
	Open-circuit voltage	$I_F = 10\text{ mA}$		0.5		V
I_{OS}	Short-circuit current limit	$I_F = 10\text{ mA}$		80		μA
C_j	Junction capacitance	$V_F = 0$, $f = 1\text{ MHz}$		12		pF

Coupler, detector bias voltage, $V_R = -15\text{ V}$

PARAMETER		TEST CONDITIONS	MIN	TYP	MAX	UNIT
$K1^\dagger$	Servo-current gain	$I_F = 1\text{ mA}$	0.3%	0.7%	1.5%	
		$I_F = 10\text{ mA}$	0.5%	1.25%	2%	
$K2^\ddagger$	Forward current gain	$I_F = 1\text{ mA}$	0.3%	0.7%	1.5%	
		$I_F = 10\text{ mA}$	0.5%	1.25%	2%	
$K3^\S$	Transfer gain	TIL300 $I_F = 1\text{ mA}$	0.75	1	1.25	
		TIL300 $I_F = 10\text{ mA}$	0.75	1	1.25	
		TIL300A $I_F = 1\text{ mA}$	0.9	1	1.10	
		TIL300A $I_F = 10\text{ mA}$	0.9	1	1.10	
Gain temperature coefficient	K1/K2	$I_F = 10\text{ mA}$		-0.5		% / °C
	K3	$I_F = 10\text{ mA}$		± 0.005		
$\Delta K3^\P$	Transfer gain linearity	$I_F = 1\text{ to }10\text{ mA}$		$\pm 0.25\%$		
		$I_F = 1\text{ to }10\text{ mA}$, $T_A = 0\text{ to }75^\circ\text{C}$		$\pm 0.5\%$		
BW	Bandwidth	$I_F = 10\text{ mA}$, $I_{F(\text{MODULATION})} = \pm 2\text{ mA}$		200		kHz
t_r	Rise time	$I_F = 10\text{ mA}$, $I_{F(\text{MODULATION})} = \pm 2\text{ mA}$		1.75		μs
t_f	Fall time	$I_F = 10\text{ mA}$, $I_{F(\text{MODULATION})} = \pm 2\text{ mA}$		1.75		μs
$V_{iso}^\#$	Peak isolation voltage	$I_{IO} = 10\text{ }\mu\text{A}$, time = 1 minute		3535		V

† Servo-current gain ($K1$) is the ratio of the feedback photodiode current (I_{P1}) to the input LED current (I_F), i.e. $K1 = I_{P1}/I_F$.

‡ Forward gain ($K2$) is the ratio of the output photodiode current (I_{P2}) to the input LED current (I_F), i.e. $K2 = I_{P2}/I_F$.

§ Transfer gain ($K3$) is the ratio of the forward gain to the servo-current gain, i.e. $K3 = K2/K1$.

¶ Transfer gain linearity ($\Delta K3$) is the percent deviation of the transfer gain $K3$ as a function of LED input current (I_F) or the package temperature.

$^\#$ This symbol is not currently listed within EIA or JEDEC standards for semiconductor symbology.

TIL300, TIL300A PRECISION LINEAR OPTOCOUPLER

TAOS018 – AUGUST 1999

TYPICAL CHARACTERISTICS

Table of Graphs

			FIGURE
I_F	LED Forward Current	vs LED Forward Voltage	2
		vs LED Forward Voltage	3
I_{p1}	Servo Photodiode Current	vs LED Forward Current and Temperature	4
		vs LED Forward Current and Temperature	5
I_{p1}	Normalized Servo Photodiode Current	vs LED Forward Current and Temperature	6
			7
K1	Normalized Servo Current Gain	vs LED Forward Current and Temperature	8
K3	Normalized Transfer Gain	vs LED Forward Current	9
A_O	Output Current Amplitude	vs Frequency	10

TYPICAL CHARACTERISTICS

LED FORWARD CURRENT
vs
LED FORWARD VOLTAGE

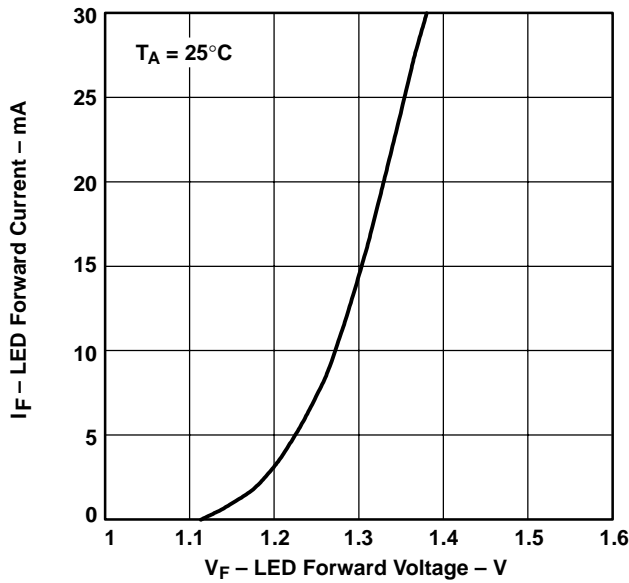

Figure 2

LED FORWARD CURRENT
vs
LED FORWARD VOLTAGE

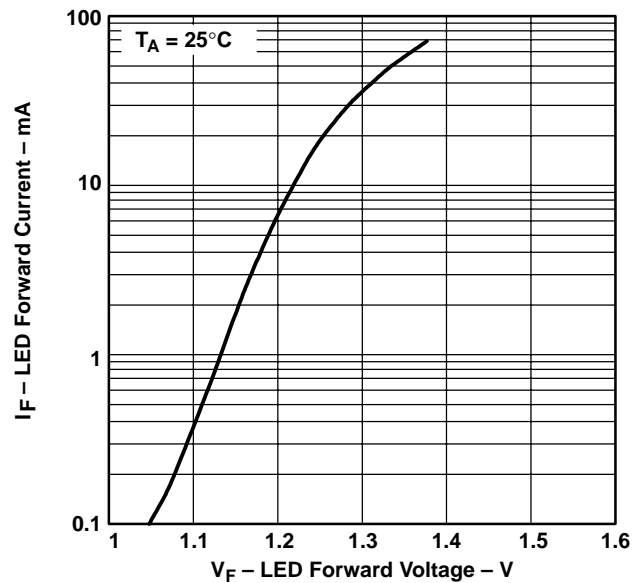

Figure 3

SERVO PHOTODIODE CURRENT
vs
LED FORWARD CURRENT AND TEMPERATURE

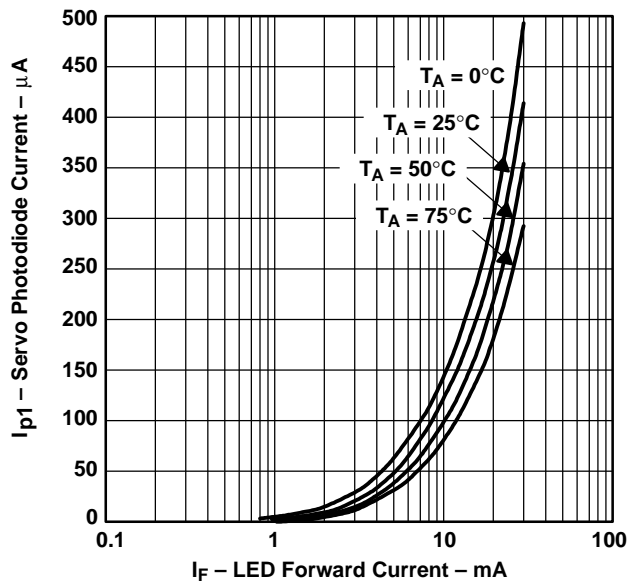

Figure 4

SERVO PHOTODIODE CURRENT
vs
LED FORWARD CURRENT AND TEMPERATURE

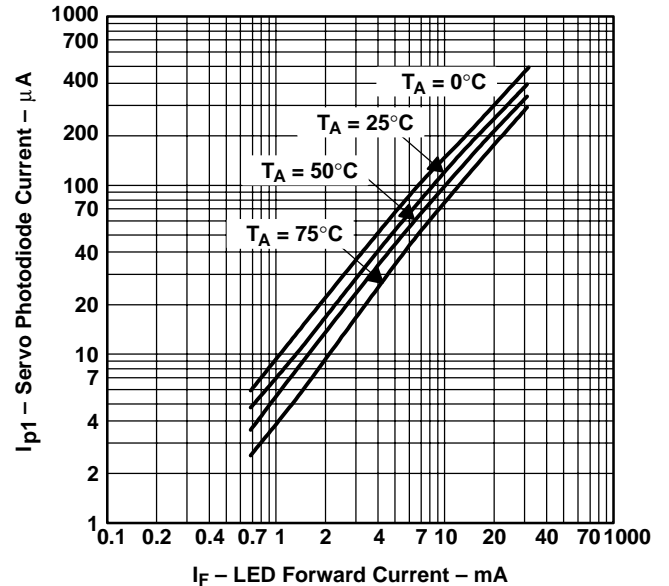

Figure 5

TIL300, TIL300A PRECISION LINEAR OPTOCOUPLER

TAOS018 – AUGUST 1999

TYPICAL CHARACTERISTICS

NORMALIZED SERVO PHOTODIODE CURRENT
vs
LED FORWARD CURRENT AND TEMPERATURE

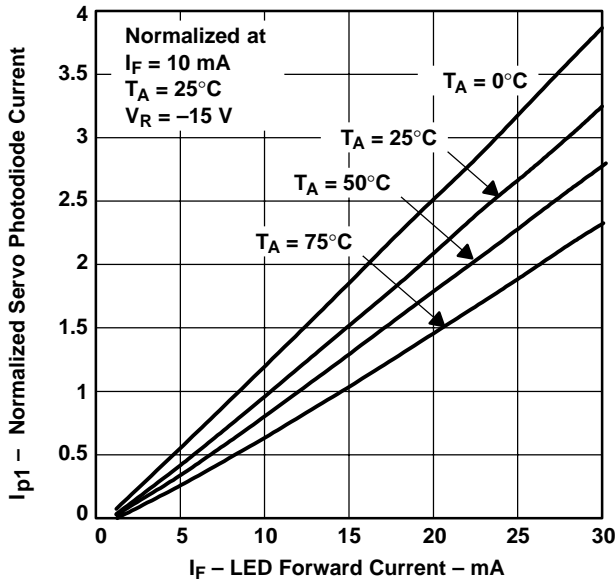

Figure 6

NORMALIZED SERVO PHOTODIODE CURRENT
vs
LED FORWARD CURRENT AND TEMPERATURE

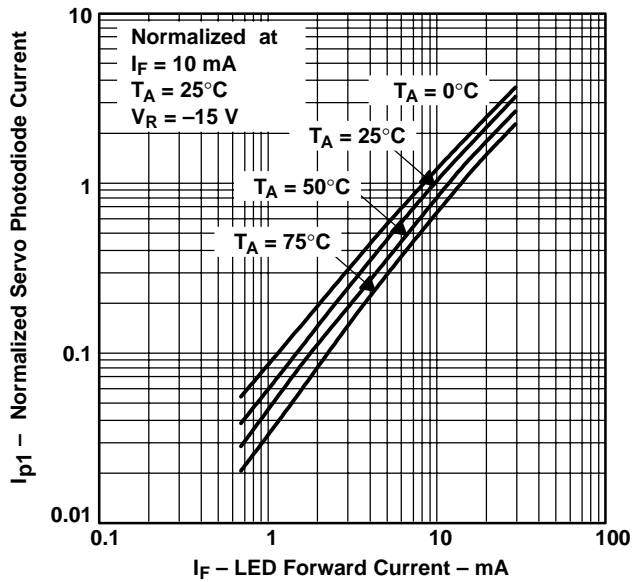

Figure 7

NORMALIZED SERVO CURRENT GAIN
vs
LED FORWARD CURRENT AND TEMPERATURE

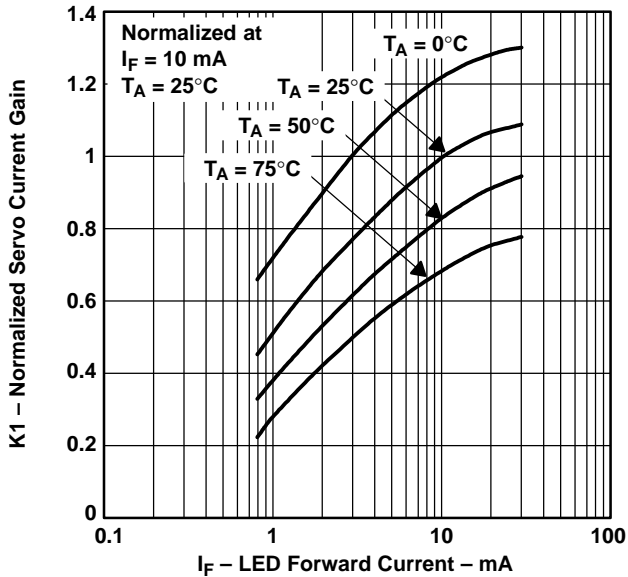

Figure 8

NORMALIZED TRANSFER GAIN
vs
LED FORWARD CURRENT

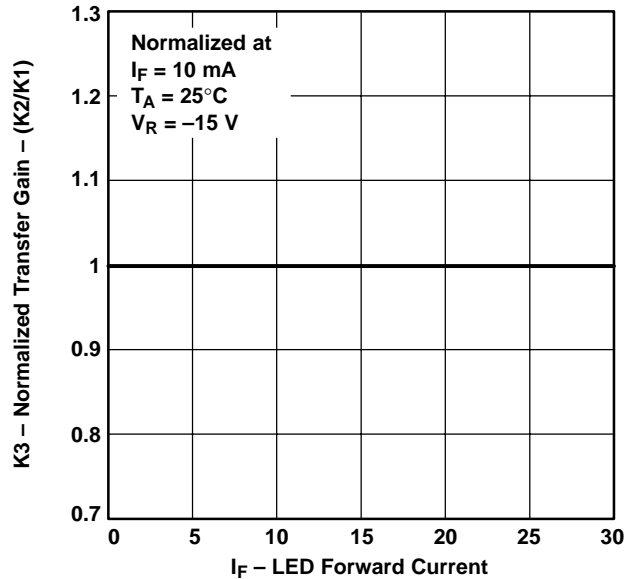

Figure 9

TYPICAL CHARACTERISTICS

OUTPUT CURRENT AMPLITUDE
vs
FREQUENCY

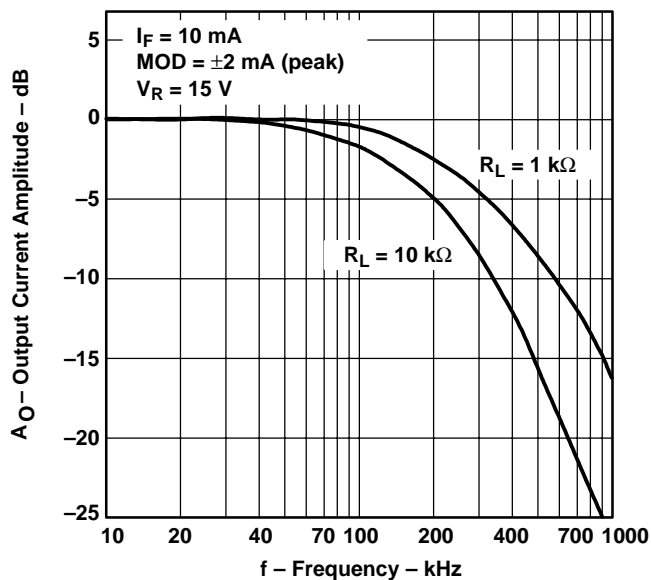

Figure 10

TIL300, TIL300A PRECISION LINEAR OPTOCOUPLER

TAOS018 – AUGUST 1999

MECHANICAL DATA

DCS (R-PDSO-G8)

PLASTIC DUAL SMALL-OUTLINE OPTO COUPLER

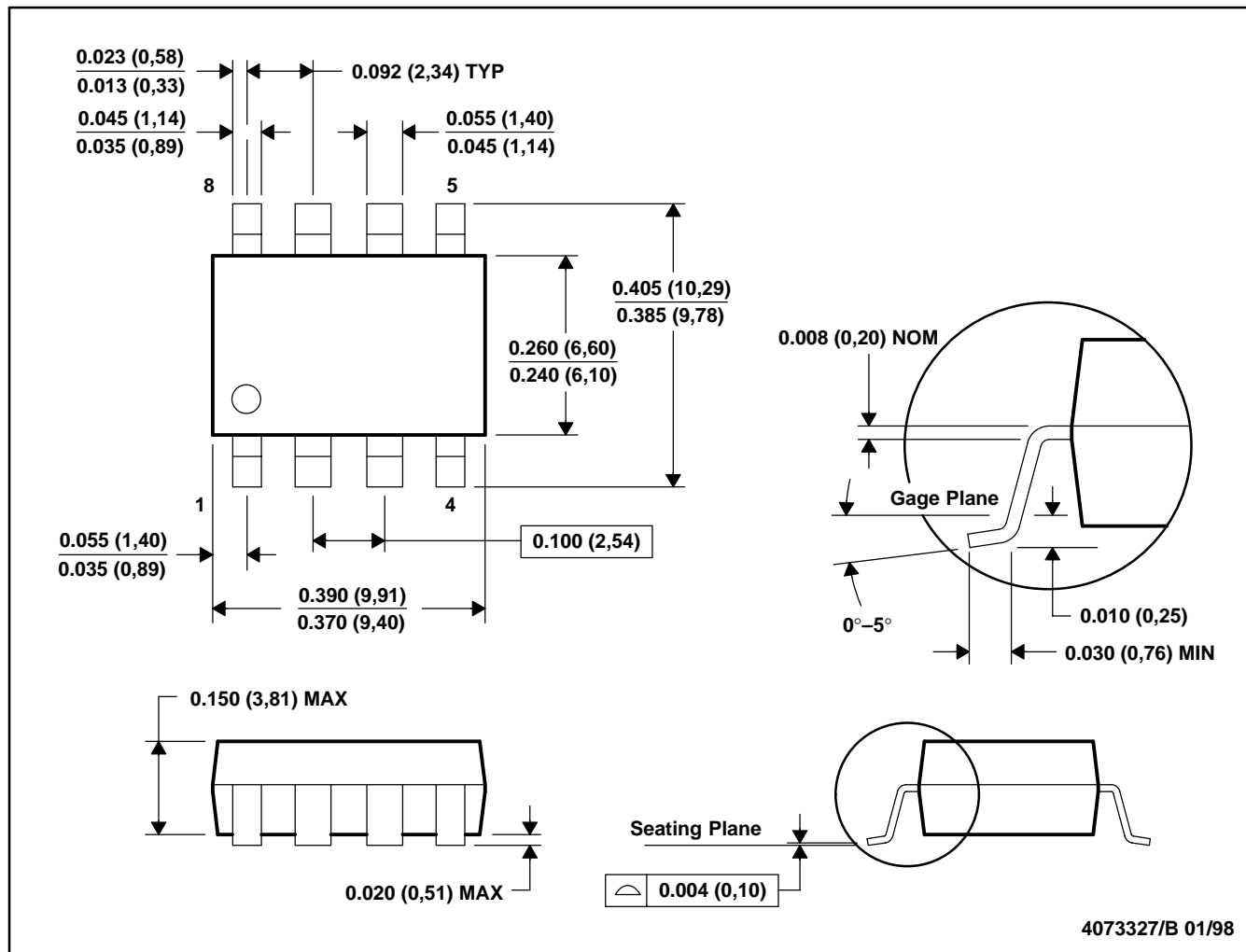

NOTES: A. All linear dimensions are in inches(millimeters).
B. This drawing is subject to change without notice.

TIL300, TIL300A PRECISION LINEAR OPTOCOUPLER

TAOS018 – AUGUST 1999

MECHANICAL DATA

P (R-PDIP-T8)

PLASTIC DUAL-IN-LINE PACKAGE

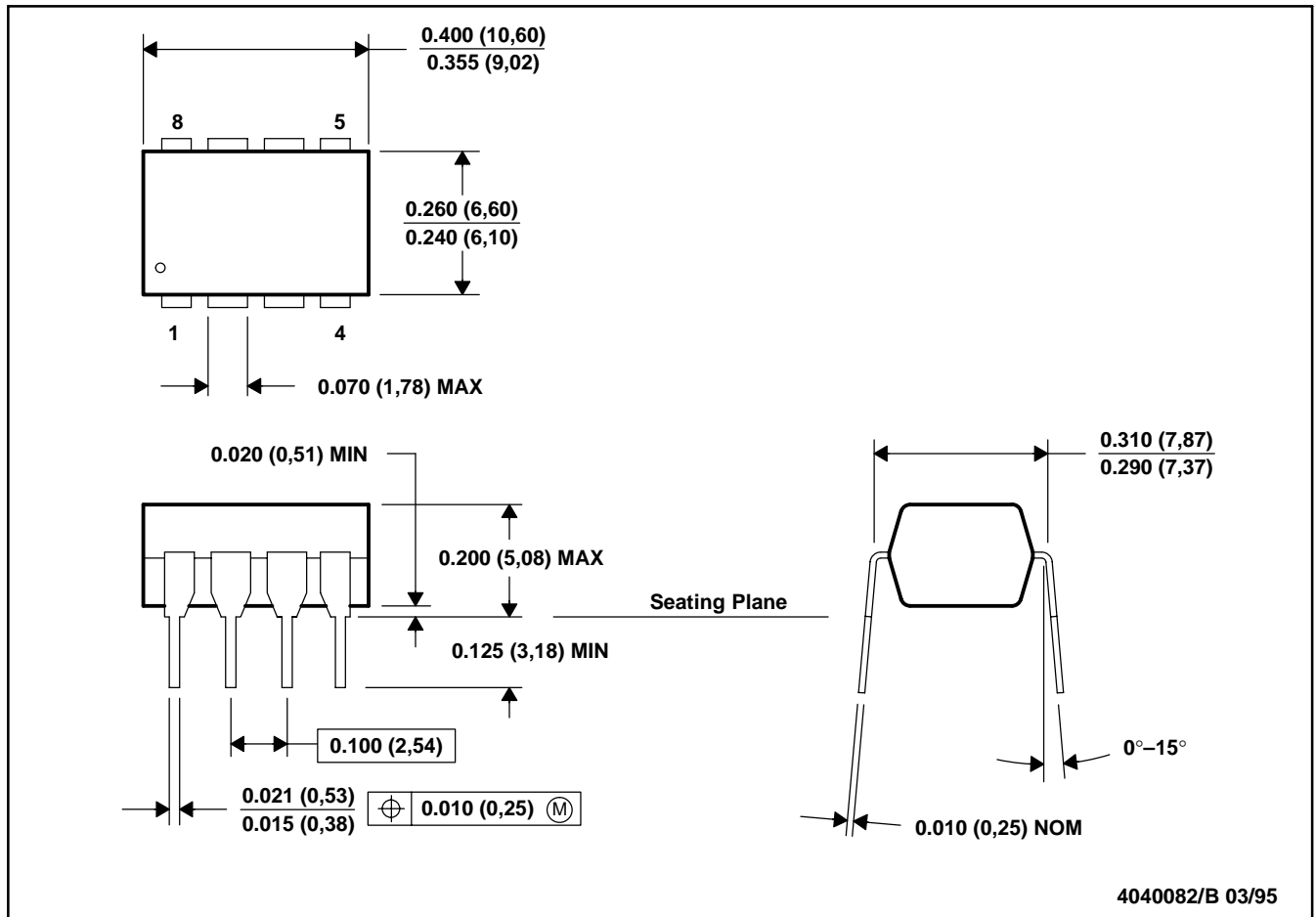

- NOTES: A. All linear dimensions are in inches (millimeters).
 B. This drawing is subject to change without notice.
 C. Falls within JEDEC MS-001

TIL300, TIL300A PRECISION LINEAR OPTOCOUPLER

TAOS018 – AUGUST 1999

PRODUCTION DATA — information in this document is current at publication date. Products conform to specifications in accordance with the terms of Texas Advanced Optoelectronic Solutions, Inc. standard warranty. Production processing does not necessarily include testing of all parameters.

NOTICE

Texas Advanced Optoelectronic Solutions, Inc. (TAOS) reserves the right to make changes to the products contained in this document to improve performance or for any other purpose, or to discontinue them without notice. Customers are advised to contact TAOS to obtain the latest product information before placing orders or designing TAOS products into systems.

TAOS assumes no responsibility for the use of any products or circuits described in this document or customer product design, conveys no license, either expressed or implied, under any patent or other right, and makes no representation that the circuits are free of patent infringement. TAOS further makes no claim as to the suitability of its products for any particular purpose, nor does TAOS assume any liability arising out of the use of any product or circuit, and specifically disclaims any and all liability, including without limitation consequential or incidental damages.

TEXAS ADVANCED OPTOELECTRONIC SOLUTIONS, INC. PRODUCTS ARE NOT DESIGNED OR INTENDED FOR USE IN CRITICAL APPLICATIONS IN WHICH THE FAILURE OR MALFUNCTION OF THE TAOS PRODUCT MAY RESULT IN PERSONAL INJURY OR DEATH. USE OF TAOS PRODUCTS IN LIFE SUPPORT SYSTEMS IS EXPRESSLY UNAUTHORIZED AND ANY SUCH USE BY A CUSTOMER IS COMPLETELY AT THE CUSTOMER'S RISK.