

Plastic Medium-Power Complementary Silicon Transistors

... designed for general-purpose amplifier and low-speed switching applications.

- High DC Current Gain —
 $h_{FE} = 2500$ (Typ) @ $I_C = 4.0$ Adc
- Collector-Emitter Sustaining Voltage — @ 30 mAdc
 $V_{CEO(sus)} = 60$ Vdc (Min) — TIP100, TIP105
 $= 80$ Vdc (Min) — TIP101, TIP106
 $= 100$ Vdc (Min) — TIP102, TIP107
- Low Collector-Emitter Saturation Voltage —
 $V_{CE(sat)} = 2.0$ Vdc (Max) @ $I_C = 3.0$ Adc
 $= 2.5$ Vdc (Max) @ $I_C = 8.0$ Adc
- Monolithic Construction with Built-in Base-Emitter Shunt Resistors
- TO-220AB Compact Package

***MAXIMUM RATINGS**

Rating	Symbol	TIP100, TIP105	TIP101, TIP106	TIP102, TIP107	Unit
Collector-Emitter Voltage	V_{CEO}	60	80	100	Vdc
Collector-Base Voltage	V_{CB}	60	80	100	Vdc
Emitter-Base Voltage	V_{EB}	5.0			Vdc
Collector Current — Continuous	I_C	8.0			Adc
Peak		15			
Base Current	I_B	1.0			Adc
Total Power Dissipation @ $T_C = 25^\circ\text{C}$	P_D	80			Watts
Derate above 25°C		0.64			
Unclamped Inductive Load Energy (1)	E	30			mJ
Total Power Dissipation @ $T_A = 25^\circ\text{C}$	P_D	2.0			Watts
Derate above 25°C		0.016			
Operating and Storage Junction Temperature Range	T_J, T_{stg}	-65 to +150			$^\circ\text{C}$

THERMAL CHARACTERISTICS

Characteristic	Symbol	Max	Unit
Thermal Resistance, Junction to Case	$R_{\theta JC}$	1.56	$^\circ\text{C/W}$
Thermal Resistance, Junction to Ambient	$R_{\theta JA}$	62.5	$^\circ\text{C/W}$

(1) $I_C = 1.1$ A, $L = 50$ mH, P.R.F. = 10 Hz, $V_{CC} = 20$ V, $R_{BE} = 100 \Omega$.

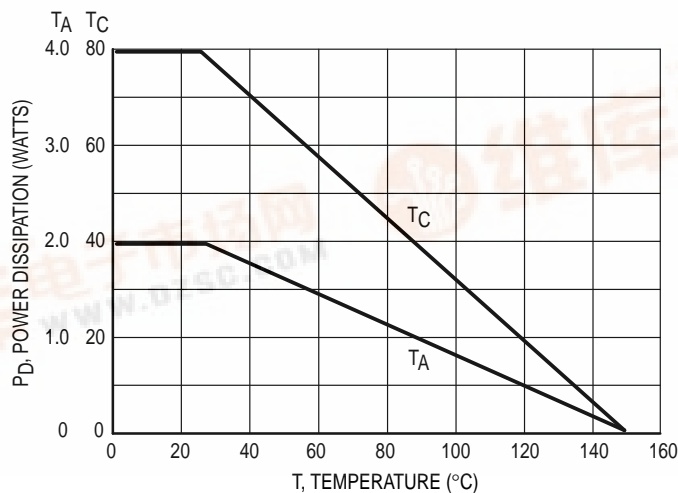

Figure 1. Power Derating

Preferred devices are Motorola recommended choices for future use and best overall value.

NPN
TIP100
TIP101*
TIP102*
PNP
TIP105
TIP106*
TIP107*

*Motorola Preferred Device

DARLINGTON
8 AMPERE
COMPLEMENTARY SILICON
POWER TRANSISTORS
60-80-100 VOLTS
80 WATTS

CASE 221A-06
TO-220AB

TIP100 TIP101 TIP102 TIP105 TIP106 TIP107

ELECTRICAL CHARACTERISTICS (T_C = 25°C unless otherwise noted)

Characteristic	Symbol	Min	Max	Unit
OFF CHARACTERISTICS				
Collector–Emitter Sustaining Voltage (1) (I _C = 30 mA, I _B = 0)	V _{CEO(sus)}	60 80 100	— — —	Vdc
Collector Cutoff Current (V _{CE} = 30 Vdc, I _B = 0) (V _{CE} = 40 Vdc, I _B = 0) (V _{CE} = 50 Vdc, I _B = 0)	I _{CEO}	— — —	50 50 50	μAdc
Collector Cutoff Current (V _{CB} = 60 Vdc, I _E = 0) (V _{CB} = 80 Vdc, I _E = 0) (V _{CB} = 100 Vdc, I _E = 0)	I _{CBO}	— — —	50 50 50	μAdc
Emitter Cutoff Current (V _{BE} = 5.0 Vdc, I _C = 0)	I _{EBO}	—	8.0	mA
ON CHARACTERISTICS (1)				
DC Current Gain (I _C = 3.0 Adc, V _{CE} = 4.0 Vdc) (I _C = 8.0 Adc, V _{CE} = 4.0 Vdc)	h _{FE}	1000 200	20,000 —	—
Collector–Emitter Saturation Voltage (I _C = 3.0 Adc, I _B = 6.0 mA) (I _C = 8.0 Adc, I _B = 80 mA)	V _{CE(sat)}	— —	2.0 2.5	Vdc
Base–Emitter On Voltage (I _C = 8.0 Adc, V _{CE} = 4.0 Vdc)	V _{BE(on)}	—	2.8	Vdc
DYNAMIC CHARACTERISTICS				
Small–Signal Current Gain (I _C = 3.0 Adc, V _{CE} = 4.0 Vdc, f = 1.0 MHz)	h _{fe}	4.0	—	—
Output Capacitance (V _{CB} = 10 Vdc, I _E = 0, f = 0.1 MHz)	C _{ob}	— —	300 200	pF

(1) Pulse Test: Pulse Width ≤ 300 μs, Duty Cycle ≤ 2%.

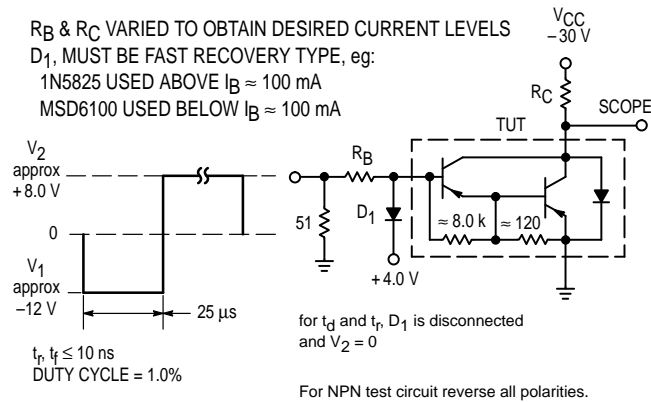

Figure 2. Switching Times Test Circuit

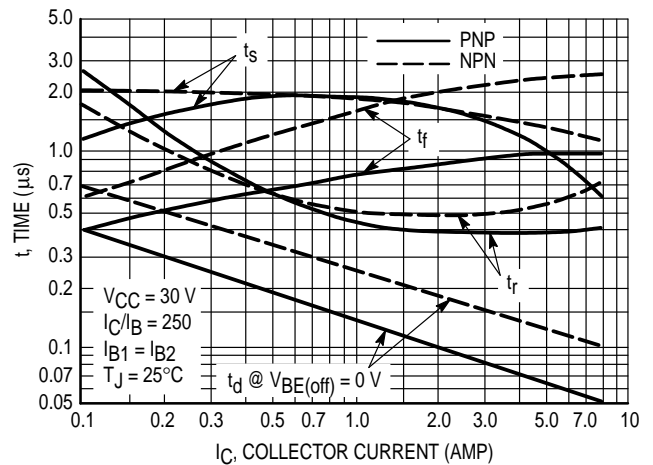

Figure 3. Switching Times

TIP100 TIP101 TIP102 TIP105 TIP106 TIP107

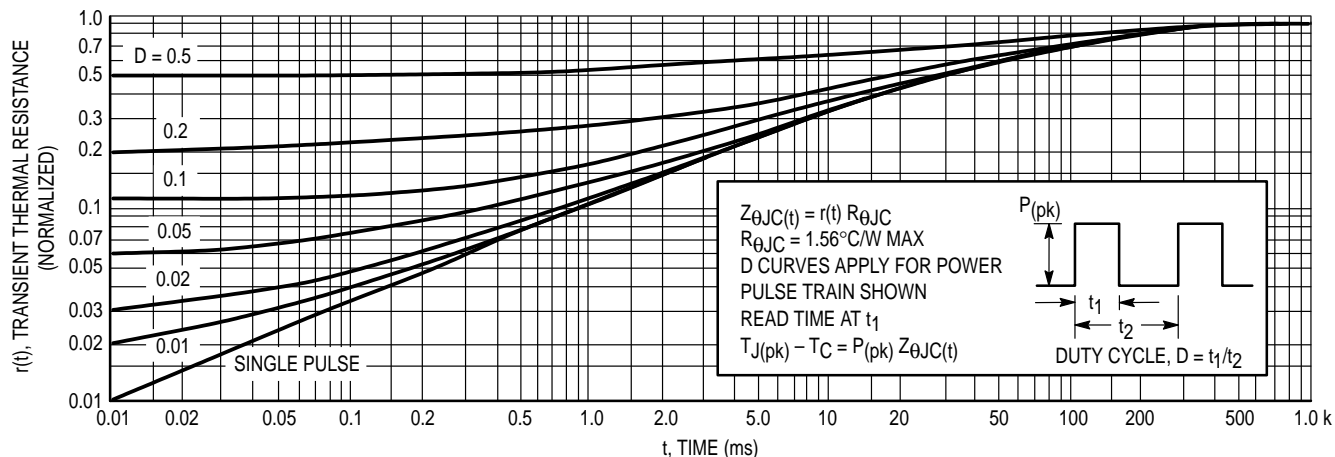

Figure 4. Thermal Response

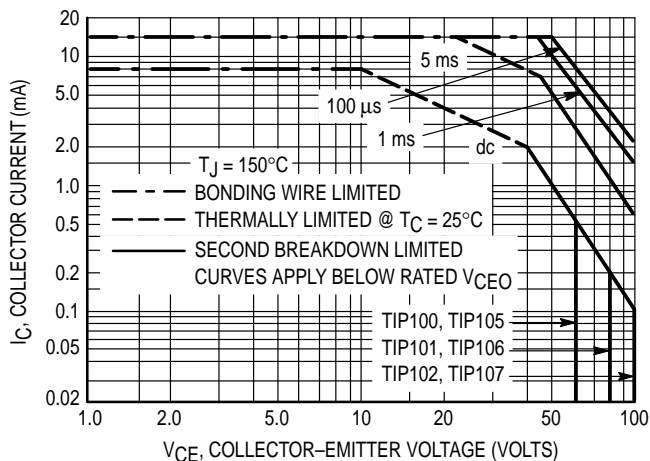

Figure 5. Active-Region Safe Operating Area

There are two limitations on the power handling ability of a transistor: average junction temperature and second breakdown. Safe operating area curves indicate $I_C - V_{CE}$ limits of the transistor that must be observed for reliable operation; i.e., the transistor must not be subjected to greater dissipation than the curves indicate.

The data of Figure 5 is based on $T_J(pk) = 150^\circ\text{C}$; T_C is variable depending on conditions. Second breakdown pulse limits are valid for duty cycles to 10% provided $T_J(pk) < 150^\circ\text{C}$. $T_J(pk)$ may be calculated from the data in Figure 4. At high case temperatures, thermal limitations will reduce the power that can be handled to values less than the limitations imposed by second breakdown

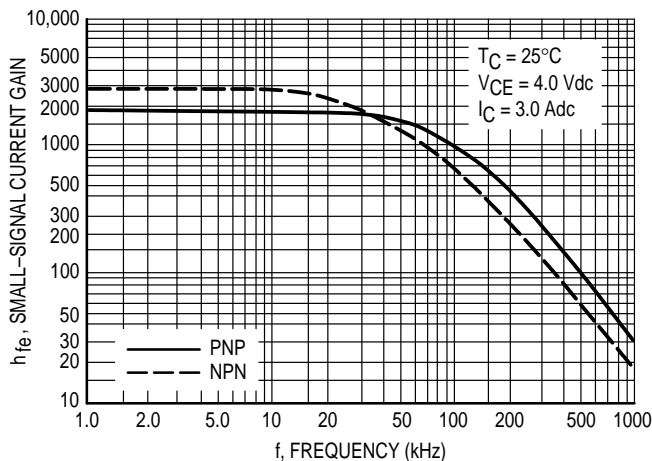

Figure 6. Small-Signal Current Gain

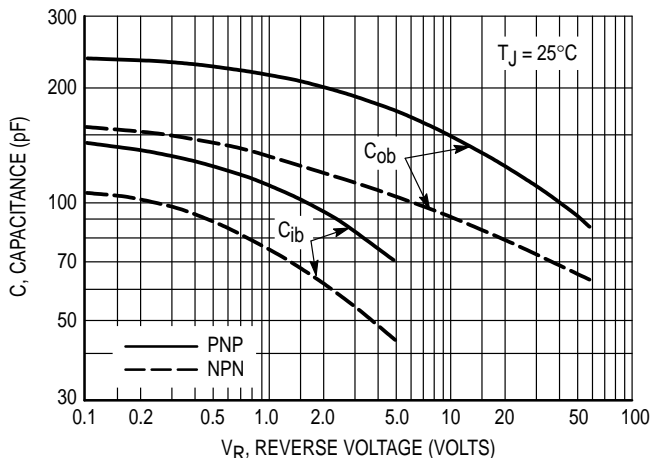

Figure 7. Capacitance

TIP100 TIP101 TIP102 TIP105 TIP106 TIP107

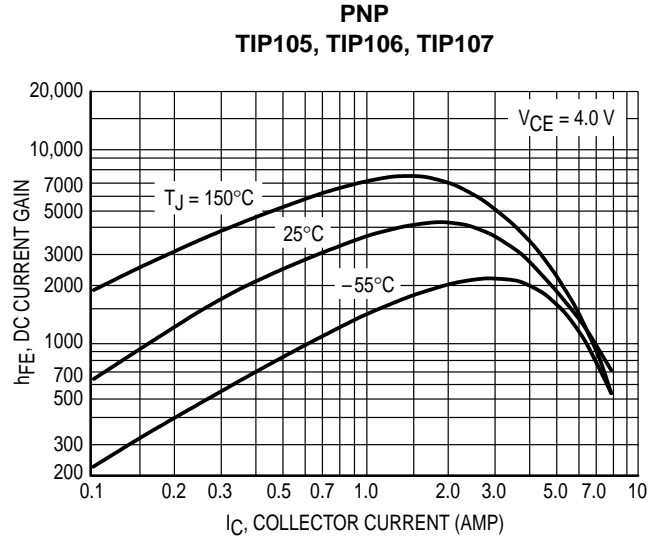
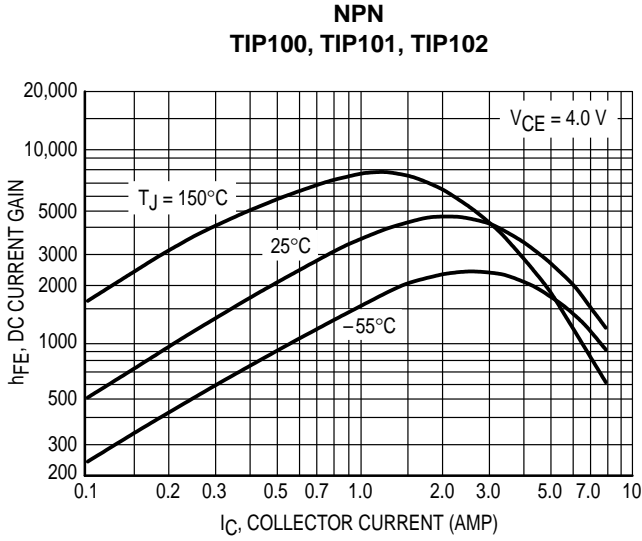

Figure 8. DC Current Gain

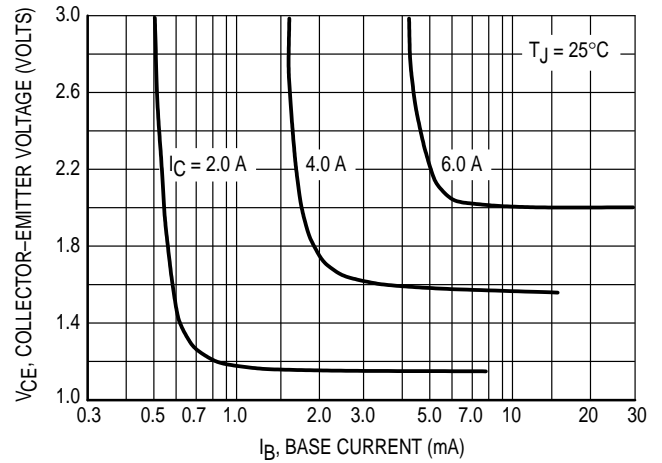
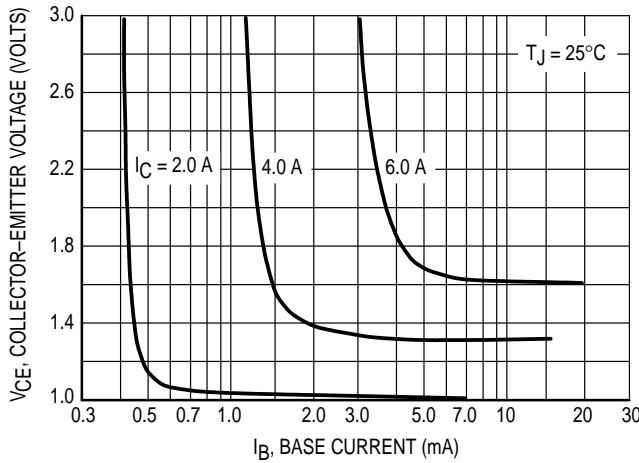

Figure 9. Collector Saturation Region

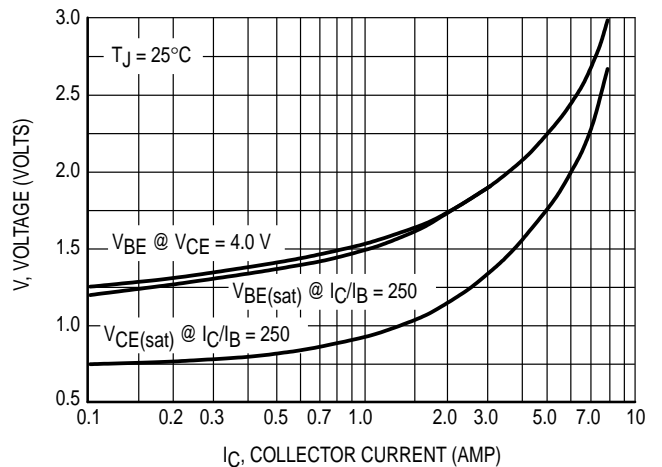
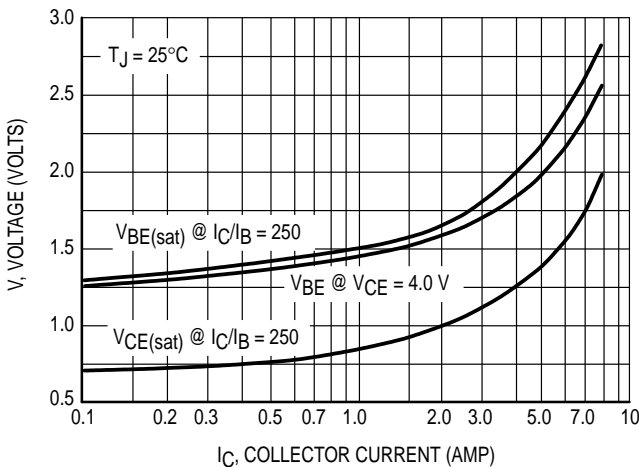
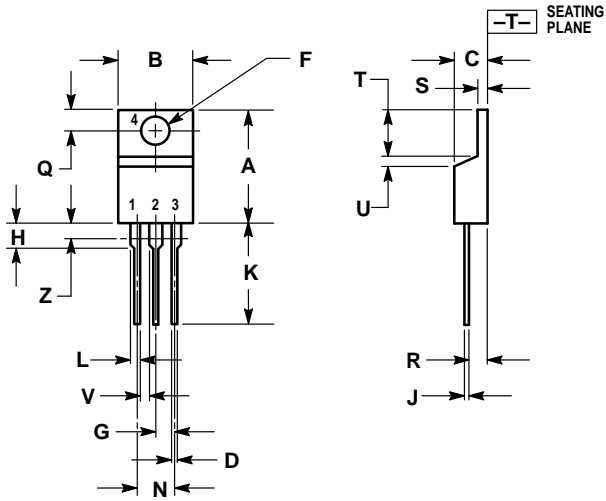

Figure 10. "On" Voltages

TIP100 TIP101 TIP102 TIP105 TIP106 TIP107

PACKAGE DIMENSIONS



- NOTES:
1. DIMENSIONING AND TOLERANCING PER ANSI Y14.5M, 1982.
 2. CONTROLLING DIMENSION: INCH.
 3. DIMENSION Z DEFINES A ZONE WHERE ALL BODY AND LEAD IRREGULARITIES ARE ALLOWED.

DIM	INCHES		MILLIMETERS	
	MIN	MAX	MIN	MAX
A	0.570	0.620	14.48	15.75
B	0.380	0.405	9.66	10.28
C	0.160	0.190	4.07	4.82
D	0.025	0.035	0.64	0.88
F	0.142	0.147	3.61	3.73
G	0.095	0.105	2.42	2.66
H	0.110	0.155	2.80	3.93
J	0.018	0.025	0.46	0.64
K	0.500	0.562	12.70	14.27
L	0.045	0.060	1.15	1.52
N	0.190	0.210	4.83	5.33
Q	0.100	0.120	2.54	3.04
R	0.080	0.110	2.04	2.79
S	0.045	0.055	1.15	1.39
T	0.235	0.255	5.97	6.47
U	0.000	0.050	0.00	1.27
V	0.045	—	1.15	—
Z	—	0.080	—	2.04

- STYLE 1:
 PIN 1. BASE
 2. COLLECTOR
 3. EMITTER
 4. COLLECTOR

**CASE 221A-06
 TO-220AB
 ISSUE Y**

TIP100 TIP101 TIP102 TIP105 TIP106 TIP107

Motorola reserves the right to make changes without further notice to any products herein. Motorola makes no warranty, representation or guarantee regarding the suitability of its products for any particular purpose, nor does Motorola assume any liability arising out of the application or use of any product or circuit, and specifically disclaims any and all liability, including without limitation consequential or incidental damages. "Typical" parameters can and do vary in different applications. All operating parameters, including "Typicals" must be validated for each customer application by customer's technical experts. Motorola does not convey any license under its patent rights nor the rights of others. Motorola products are not designed, intended, or authorized for use as components in systems intended for surgical implant into the body, or other applications intended to support or sustain life, or for any other application in which the failure of the Motorola product could create a situation where personal injury or death may occur. Should Buyer purchase or use Motorola products for any such unintended or unauthorized application, Buyer shall indemnify and hold Motorola and its officers, employees, subsidiaries, affiliates, and distributors harmless against all claims, costs, damages, and expenses, and reasonable attorney fees arising out of, directly or indirectly, any claim of personal injury or death associated with such unintended or unauthorized use, even if such claim alleges that Motorola was negligent regarding the design or manufacture of the part. Motorola and  are registered trademarks of Motorola, Inc. Motorola, Inc. is an Equal Opportunity/Affirmative Action Employer.

How to reach us:

USA / EUROPE: Motorola Literature Distribution;
P.O. Box 20912; Phoenix, Arizona 85036. 1-800-441-2447

MFAX: RMFAX0@email.sps.mot.com – TOUCHTONE (602) 244-6609
INTERNET: <http://Design-NET.com>

JAPAN: Nippon Motorola Ltd.; Tatsumi-SPD-JLDC, Toshikatsu Otsuki,
6F Seibu-Butsuryu-Center, 3-14-2 Tatsumi Koto-Ku, Tokyo 135, Japan. 03-3521-8315

HONG KONG: Motorola Semiconductors H.K. Ltd.; 8B Tai Ping Industrial Park,
51 Ting Kok Road, Tai Po, N.T., Hong Kong. 852-26629298

