



TISP4070H3BJ THRU TISP4115H3BJ,  
TISP4125H3BJ THRU TISP4220H3BJ,  
TISP4240H3BJ THRU TISP4400H3BJ

## BIDIRECTIONAL THYRISTOR OVERVOLTAGE PROTECTORS

### TISP4xxxH3BJ Overvoltage Protector Series

#### TISP4xxxH3BJ Overview

This TISP<sup>®</sup> device series protects central office, access and customer premise equipment against overvoltages on the telecom line. The TISP4xxxH3BJ is available in a wide range of voltages and has a high current capability, allowing minimal series resistance to be used. These protectors have been specified mindful of the following standards and recommendations: GR-1089-CORE, FCC Part 68, UL1950, EN 60950, IEC 60950, ITU-T K.20, K.21 and K.45. The TISP4350H3BJ meets the FCC Part 68 "B" ringer voltage requirement and survives the Type A and B impulse tests. These devices are housed in a surface mount SMB (DO-214AA) package.

#### Summary Electrical Characteristics

Part #	V <sub>DRM</sub> V	V <sub>(BO)</sub> V	V <sub>T</sub> @ I <sub>T</sub> V	I <sub>DRM</sub> μA	I <sub>(BO)</sub> mA	I <sub>T</sub> A	I <sub>H</sub> mA	C <sub>o</sub> @ -2 V pF	Functionally Replaces
TISP4070H3	58	70	3	5	600	5	150	120	P0640SC
TISP4080H3	65	80	3	5	600	5	150	120	P0720SC
TISP4095H3	75	95	3	5	600	5	150	120	P0900SC
TISP4115H3	90	115	3	5	600	5	150	120	P1100SC
TISP4125H3	100	125	3	5	600	5	150	65	
TISP4145H3	120	145	3	5	600	5	150	65	P1300SC
TISP4165H3	135	165	3	5	600	5	150	65	
TISP4180H3	145	180	3	5	600	5	150	65	P1500SC
TISP4200H3	155	200	3	5	600	5	150	65	
TISP4220H3	160	220	3	5	600	5	150	65	P1800SC
TISP4240H3	180	240	3	5	600	5	150	55	
TISP4250H3	190	250	3	5	600	5	150	55	P2300SC
TISP4265H3	200	265	3	5	600	5	150	55	
TISP4290H3	220	290	3	5	600	5	150	55	P2600SC
TISP4300H3	230	300	3	5	600	5	150	55	
TISP4350H3	275	350	3	5	600	5	150	55	P3100SC
TISP4395H3	320	395	3	5	600	5	150	55	P3500SC
TISP4400H3	300	400	3	5	600	5	150	55	

Bourns part has an improved protection voltage

#### Summary Current Ratings

Parameter	I <sub>TSP</sub> A						I <sub>TSM</sub> A	di/dt A/μs
	2/10	1.2/50, 8/20	10/160	5/320	10/560	10/1000	1 cycle 60 Hz	2/10 Wavefront
Value	500	300	250	200	160	100	60	400

\*RoHS Directive 2002/95/EC Jan 27 2003 including Annex  
NOVEMBER 1997 - REVISED FEBRUARY 2005

Specifications are subject to change without notice.  
Customers should verify actual device performance in their specific applications.

# TISP4xxxH3BJ Overvoltage Protector Series



ITU-T K.20/21 Rating . . . . . 8 kV 10/700, 200 A 5/310

Ion-Implanted Breakdown Region  
Precise and Stable Voltage  
Low Voltage Overshoot under Surge

Device	V <sub>DRM</sub> V	V <sub>(BO)</sub> V
'4070	58	70
'4080	65	80
'4095	75	95
'4115	90	115
'4125	100	125
'4145	120	145
'4165	135	165
'4180	145	180
'4200	155	200
'4220	160	220
'4240	180	240
'4250	190	250
'4265	200	265
'4290	220	290
'4300	230	300
'4350	275	350
'4395	320	395
'4400	300	400

Low Differential Capacitance .....67 pF max.

..... UL Recognized Component

## SMBJ Package (Top View)

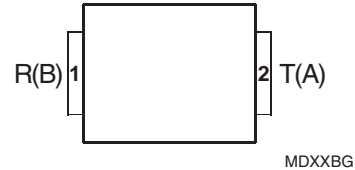

## Device Symbol



Terminals T and R correspond to the alternative line designators of A and B

## Rated for International Surge Wave Shapes

Waveshape	Standard	I <sub>TSP</sub> A
2/10 μs	GR-1089-CORE	500
8/20 μs	IEC 61000-4-5	300
10/160 μs	FCC Part 68	250
10/700 μs	ITU-T K.20/21	200
10/560 μs	FCC Part 68	160
10/1000 μs	GR-1089-CORE	100

## Description

These devices are designed to limit overvoltages on the telephone line. Overvoltages are normally caused by a.c. power system or lightning flash disturbances which are induced or conducted on to the telephone line. A single device provides 2-point protection and is typically used for the protection of 2-wire telecommunication equipment (e.g. between the Ring and Tip wires for telephones and modems). Combinations of devices can be used for multi-point protection (e.g. 3-point protection between Ring, Tip and Ground).

The protector consists of a symmetrical voltage-triggered bidirectional thyristor. Overvoltages are initially clipped by breakdown clamping until the voltage rises to the breakover level, which causes the device to crowbar into a low-voltage on state. This low-voltage on state causes the current resulting from the overvoltage to be safely diverted through the device. The high crowbar holding current prevents d.c. latchup as the diverted current subsides.

This TISP4xxxH3BJ range consists of eighteen voltage variants to meet various maximum system voltage levels (58 V to 320 V). They are guaranteed to voltage limit and withstand the listed international lightning surges in both polarities. These high (H) current protection devices are in a plastic package SMBJ (JEDEC DO-214AA with J-bend leads) and supplied in embossed carrier reel pack. For alternative voltage and holding current values, consult the factory. For lower rated impulse currents in the SMB package, the 50 A 10/1000 TISP4xxxM3BJ series is available.

## How To Order

Device	Package	Carrier	For Standard Termination Finish Order As	For Lead Free Termination Finish Order As
TISP4xxxH3BJ	BJ (J-Bend DO-214AA/SMB)	Embossed Tape Reeled	TISP4xxxH3BJR	TISP4xxxH3BJR-S
		Bulk Pack	TISP4xxxH3BJ	TISP4xxxH3BJ-S

Insert xxx value corresponding to protection voltages of 070, 080, 095, 115 etc.

NOVEMBER 1997 - REVISED FEBRUARY 2005

Specifications are subject to change without notice.  
Customers should verify actual device performance in their specific applications.

# TISP4xxxH3BJ Overvoltage Protector Series

# BOURNS®

## Absolute Maximum Ratings, $T_A = 25\text{ }^\circ\text{C}$ (Unless Otherwise Noted)

Rating	Symbol	Value	Unit
Repetitive peak off-state voltage, (see Note 1)	'4070	$\pm 58$	V
	'4080	$\pm 65$	
	'4095	$\pm 75$	
	'4115	$\pm 90$	
	'4125	$\pm 100$	
	'4145	$\pm 120$	
	'4165	$\pm 135$	
	'4180	$\pm 145$	
	'4200	$\pm 155$	
	'4220	$\pm 160$	
	'4240	$\pm 180$	
	'4250	$\pm 190$	
	'4265	$\pm 200$	
	'4290	$\pm 220$	
	'4300	$\pm 230$	
	'4350	$\pm 275$	
'4395	$\pm 320$		
'4400	$\pm 300$		
Non-repetitive peak on-state pulse current (see Notes 2, 3 and 4)	$I_{TSP}$	500	A
2/10 $\mu\text{s}$ (GR-1089-CORE, 2/10 $\mu\text{s}$ voltage wave shape)		300	
8/20 $\mu\text{s}$ (IEC 61000-4-5, 1.2/50 $\mu\text{s}$ voltage, 8/20 current combination wave generator)		250	
10/160 $\mu\text{s}$ (FCC Part 68, 10/160 $\mu\text{s}$ voltage wave shape)		220	
5/200 $\mu\text{s}$ (VDE 0433, 10/700 $\mu\text{s}$ voltage wave shape)		200	
0.2/310 $\mu\text{s}$ (I3124, 0.5/700 $\mu\text{s}$ voltage wave shape)		200	
5/310 $\mu\text{s}$ (ITU-T K.20/21, 10/700 $\mu\text{s}$ voltage wave shape)		200	
5/310 $\mu\text{s}$ (FTZ R12, 10/700 $\mu\text{s}$ voltage wave shape)		160	
10/560 $\mu\text{s}$ (FCC Part 68, 10/560 $\mu\text{s}$ voltage wave shape)		100	
10/1000 $\mu\text{s}$ (GR-1089-CORE, 10/1000 $\mu\text{s}$ voltage wave shape)			
Non-repetitive peak on-state current (see Notes 2, 3 and 5)	$I_{TSM}$	55	A
20 ms (50 Hz) full sine wave		60	
16.7 ms (60 Hz) full sine wave		2.1	
1000 s 50 Hz/60 Hz a.c.			
Initial rate of rise of on-state current, Exponential current ramp, Maximum ramp value < 200 A	$di_T/dt$	400	A/ $\mu\text{s}$
Junction temperature	$T_J$	-40 to +150	$^\circ\text{C}$
Storage temperature range	$T_{stg}$	-65 to +150	$^\circ\text{C}$

- NOTES: 1. See Applications Information and Figure 10 for voltage values at lower temperatures.  
 2. Initially, the TISP4xxxH3BJ must be in thermal equilibrium with  $T_J = 25\text{ }^\circ\text{C}$ .  
 3. The surge may be repeated after the TISP4xxxH3BJ returns to its initial conditions.  
 4. See Applications Information and Figure 11 for current ratings at other temperatures.  
 5. EIA/JESD51-2 environment and EIA/JESD51-3 PCB with standard footprint dimensions connected with 5 A rated printed wiring track widths. See Figure 8 for the current ratings at other durations. Derate current values at  $-0.61\text{ }^\circ\text{C}$  for ambient temperatures above  $25\text{ }^\circ\text{C}$ .

# TISP4xxxH3BJ Overvoltage Protector Series

# BOURNS®

## Electrical Characteristics, $T_A = 25\text{ °C}$ (Unless Otherwise Noted)

Parameter	Test Conditions	Min.	Typ.	Max.	Unit
$I_{DRM}$ Repetitive peak off-state current	$V_D = V_{DRM}$ $T_A = 25\text{ °C}$ $T_A = 85\text{ °C}$			$\pm 5$ $\pm 10$	$\mu A$
$V_{(BO)}$ Breakover voltage	$dv/dt = \pm 750\text{ V/ms}$ , $R_{SOURCE} = 300\ \Omega$			'4070 $\pm 70$ '4080 $\pm 80$ '4095 $\pm 95$ '4115 $\pm 115$ '4125 $\pm 125$ '4145 $\pm 145$ '4165 $\pm 165$ '4180 $\pm 180$ '4200 $\pm 200$ '4220 $\pm 220$ '4240 $\pm 240$ '4250 $\pm 250$ '4265 $\pm 265$ '4290 $\pm 290$ '4300 $\pm 300$ '4350 $\pm 350$ '4395 $\pm 395$ '4400 $\pm 400$	V
$V_{(BO)}$ Impulse breakover voltage	$dv/dt \leq \pm 1000\text{ V}/\mu s$ , Linear voltage ramp, Maximum ramp value = $\pm 500\text{ V}$ $di/dt = \pm 20\text{ A}/\mu s$ , Linear current ramp, Maximum ramp value = $\pm 10\text{ A}$			'4070 $\pm 78$ '4080 $\pm 88$ '4095 $\pm 103$ '4115 $\pm 124$ '4125 $\pm 134$ '4145 $\pm 154$ '4165 $\pm 174$ '4180 $\pm 189$ '4200 $\pm 210$ '4220 $\pm 230$ '4240 $\pm 250$ '4250 $\pm 261$ '4265 $\pm 276$ '4290 $\pm 301$ '4300 $\pm 311$ '4350 $\pm 362$ '4395 $\pm 408$ '4400 $\pm 413$	V
$I_{(BO)}$ Breakover current	$dv/dt = \pm 750\text{ V/ms}$ , $R_{SOURCE} = 300\ \Omega$	$\pm 0.15$		$\pm 0.6$	A
$V_T$ On-state voltage	$I_T = \pm 5\text{ A}$ , $t_W = 100\ \mu s$			$\pm 3$	V
$I_H$ Holding current	$I_T = \pm 5\text{ A}$ , $di/dt = -/+30\text{ mA/ms}$	$\pm 0.15$		$\pm 0.6$	A
$dv/dt$ Critical rate of rise of off-state voltage	Linear voltage ramp, Maximum ramp value $< 0.85V_{DRM}$	$\pm 5$			$kV/\mu s$
$I_D$ Off-state current	$V_D = \pm 50\text{ V}$ $T_A = 85\text{ °C}$			$\pm 10$	$\mu A$

NOVEMBER 1997 - REVISED FEBRUARY 2005

Specifications are subject to change without notice.  
Customers should verify actual device performance in their specific applications.

# TISP4xxxH3BJ Overvoltage Protector Series

**BOURNS®**

## Electrical Characteristics, $T_A = 25\text{ }^\circ\text{C}$ (Unless Otherwise Noted) (continued)

Parameter	Test Conditions	Min.	Typ.	Max.	Unit
$C_{off}$ Off-state capacitance	f = 100 kHz, $V_d = 1\text{ V rms}$ , $V_D = 0$ ,	'4070 thru '4115	145	170	pF
		'4125 thru '4220	80	90	
		'4240 thru '4400	70	84	
	f = 100 kHz, $V_d = 1\text{ V rms}$ , $V_D = -1\text{ V}$	'4070 thru '4115	130	150	
		'4125 thru '4220	71	79	
		'4240 thru '4400	60	67	
	f = 100 kHz, $V_d = 1\text{ V rms}$ , $V_D = -2\text{ V}$	'4070 thru '4115	120	140	
		'4125 thru '4220	65	74	
		'4240 thru '4400	55	62	
	f = 100 kHz, $V_d = 1\text{ V rms}$ , $V_D = -50\text{ V}$	'4070 thru '4115	62	73	
		'4125 thru '4220	30	35	
		'4240 thru '4400	24	28	
f = 100 kHz, $V_d = 1\text{ V rms}$ , $V_D = -100\text{ V}$ (see Note 6)	'4125 thru '4220	28	33		
	'4240 thru '4400	22	26		

NOTE 6: To avoid possible voltage clipping, the '4125 is tested with  $V_D = -98\text{ V}$ .

## Thermal Characteristics

Parameter	Test Conditions	Min.	Typ.	Max.	Unit
$R_{\theta JA}$ Junction to free air thermal resistance	EIA/JESD51-3 PCB, $I_T = I_{TSM}(1000)$ , $T_A = 25\text{ }^\circ\text{C}$ , (see Note 7)			113	$^\circ\text{C/W}$
	265 mm x 210 mm populated line card, 4-layer PCB, $I_T = I_{TSM}(1000)$ , $T_A = 25\text{ }^\circ\text{C}$		50		

NOTE 7: EIA/JESD51-2 environment and PCB has standard footprint dimensions connected with 5 A rated printed wiring track widths.

Parameter Measurement Information

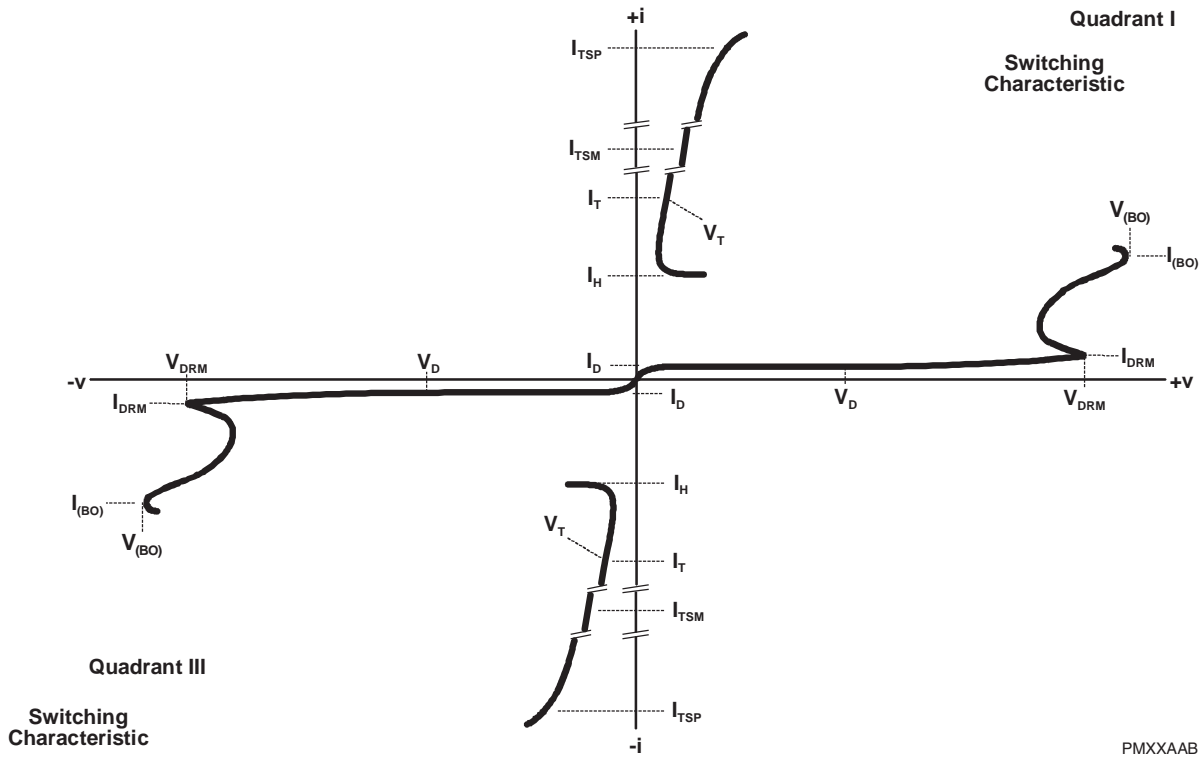

PMXXAAB

Figure 1. Voltage-current Characteristic for T and R Terminals  
All Measurements are Referenced to the R Terminal

## Typical Characteristics

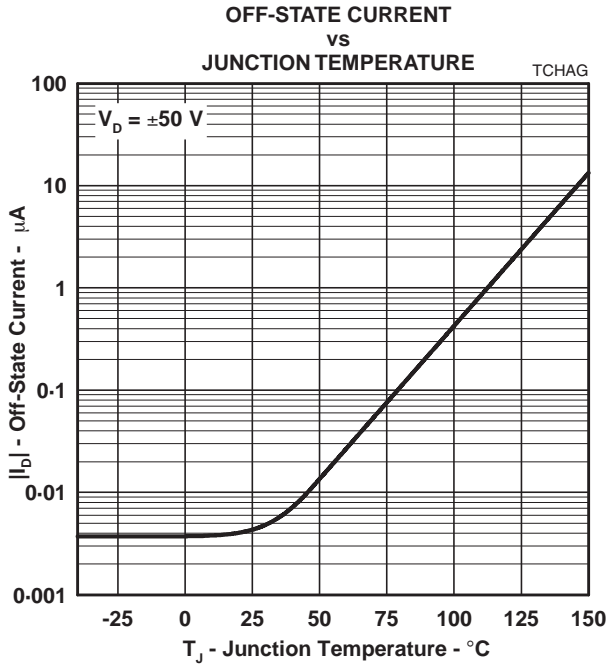

Figure 2.

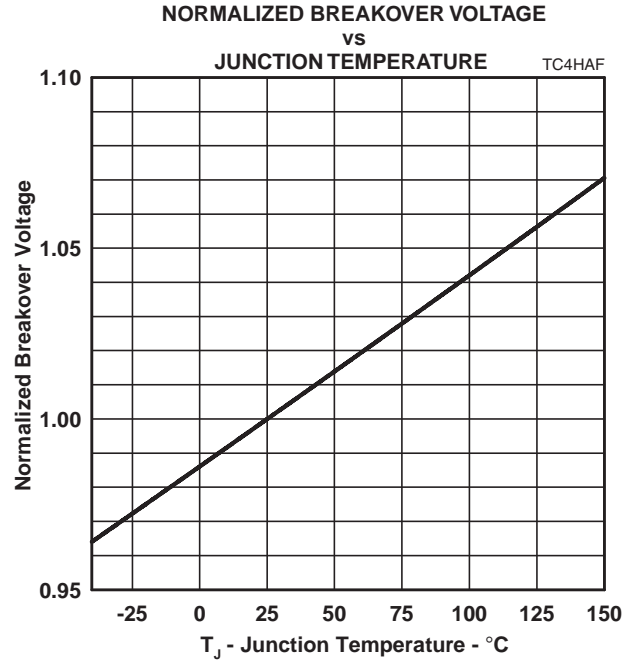

Figure 3.

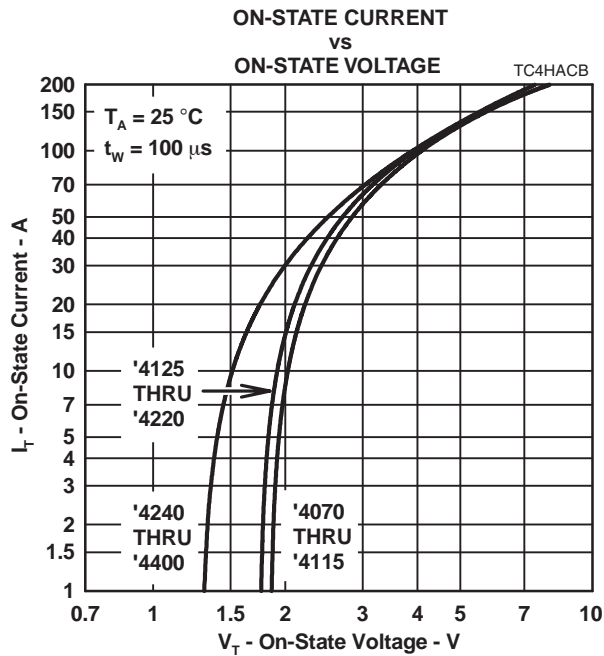

Figure 4.

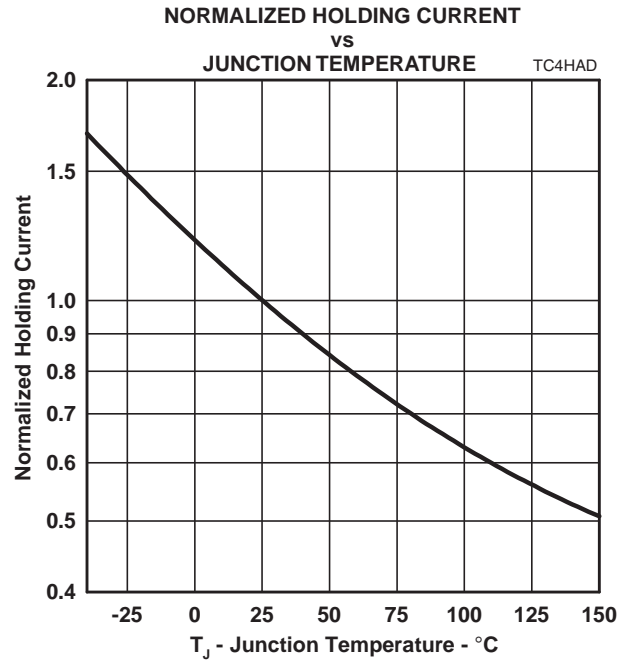

Figure 5.

## Typical Characteristics

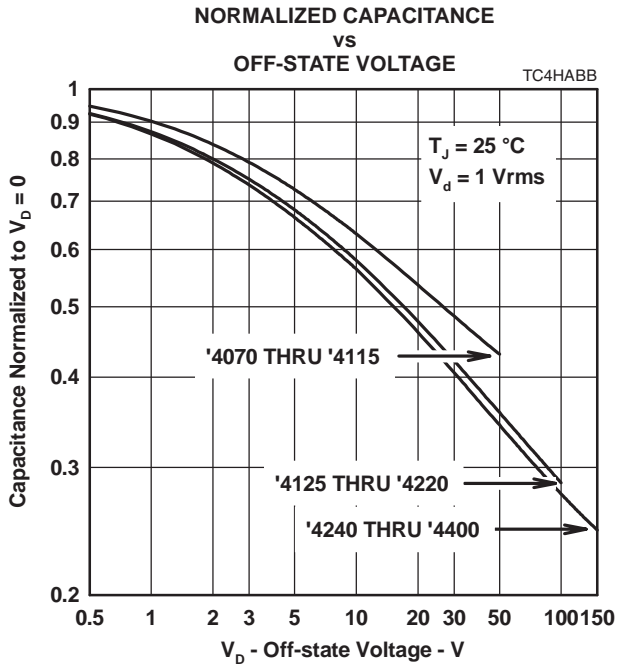

Figure 6.

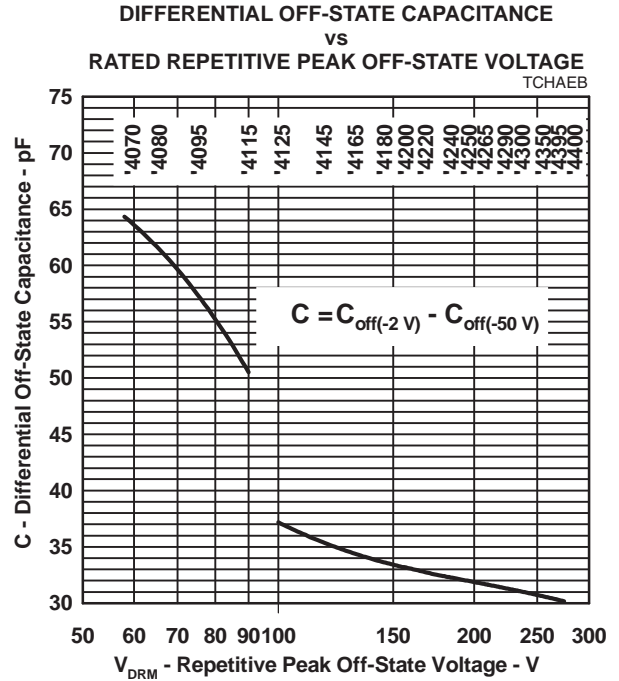
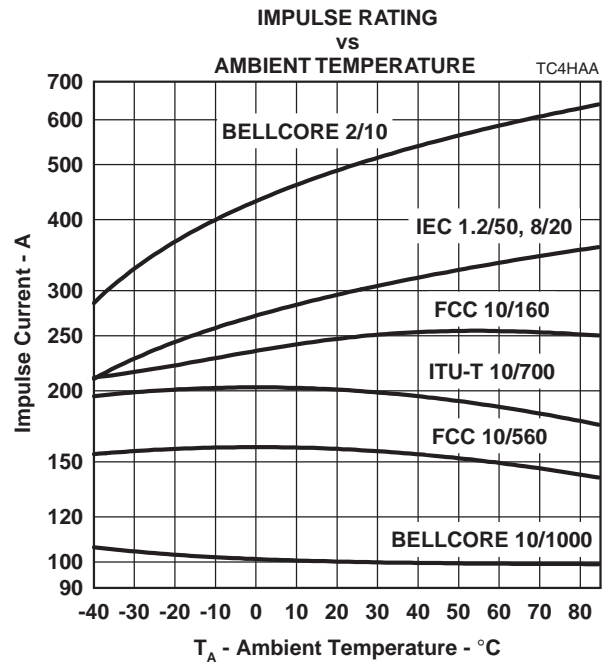
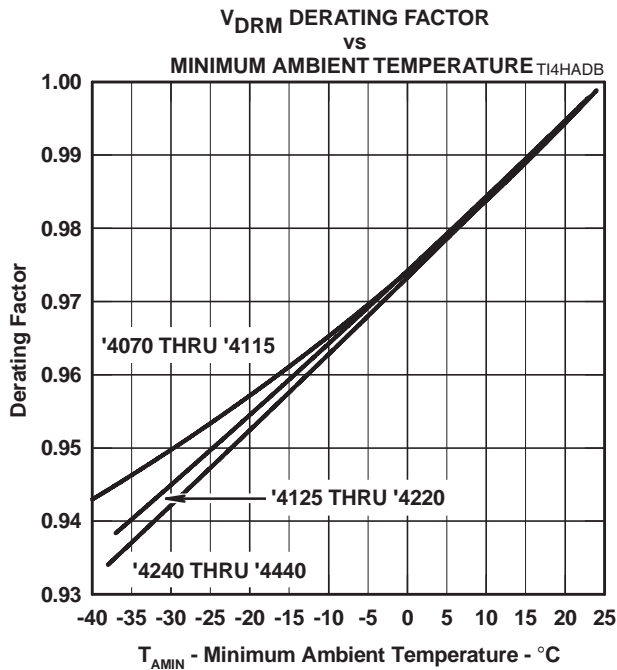
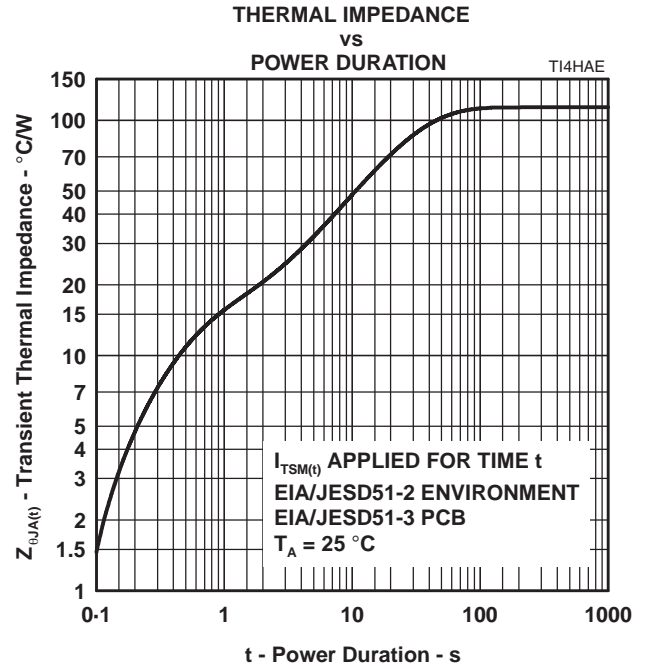
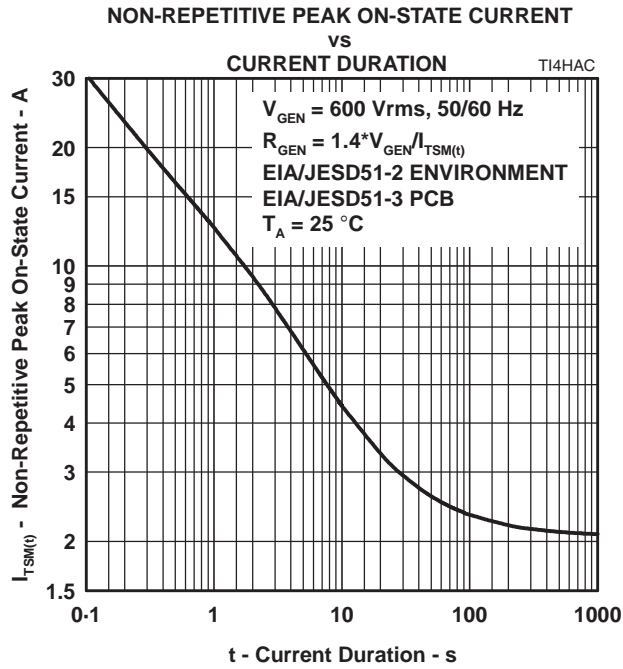

Figure 7.



## Rating and Thermal Information



## APPLICATIONS INFORMATION

### Deployment

These devices are two terminal overvoltage protectors. They may be used either singly to limit the voltage between two conductors (Figure 12) or in multiples to limit the voltage at several points in a circuit (Figure 13).

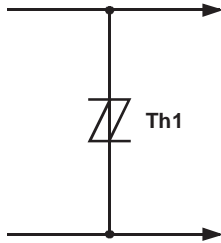

Figure 12. Two Point Protection

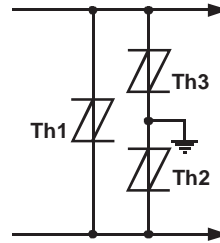

Figure 13. Multi-point Protection

In Figure 12, protector Th1 limits the maximum voltage between the two conductors to  $\pm V_{(BO)}$ . This configuration is normally used to protect circuits without a ground reference, such as modems. In Figure 13, protectors Th2 and Th3 limit the maximum voltage between each conductor and ground to the  $\pm V_{(BO)}$  of the individual protector. Protector Th1 limits the maximum voltage between the two conductors to its  $\pm V_{(BO)}$  value. If the equipment being protected has all its vulnerable components connected between the conductors and ground, then protector Th1 is not required.

### Impulse Testing

To verify the withstand capability and safety of the equipment, standards require that the equipment is tested with various impulse wave forms. The table below shows some common values.

Standard	Peak Voltage Setting V	Voltage Waveform $\mu s$	Peak Current Value A	Current Waveform $\mu s$	TISP4xxxH3 25 °C Rating A	Series Resistance $\Omega$
GR-1089-CORE	2500	2/10	500	2/10	500	0
	1000	10/1000	100	10/1000	100	
FCC Part 68 (March 1998)	1500	10/160	200	10/160	250	0
	800	10/560	100	10/560	160	0
	1500	9/720 †	37.5	5/320 †	200	0
	1000	9/720 †	25	5/320 †	200	0
I3124	1500	0.5/700	37.5	0.2/310	200	0
ITU-T K.20/K.21	1500	10/700	37.5	5/310	200	0
	4000		100			

† FCC Part 68 terminology for the waveforms produced by the ITU-T recommendation K.21 10/700 impulse generator

If the impulse generator current exceeds the protector's current rating, then a series resistance can be used to reduce the current to the protector's rated value to prevent possible failure. The required value of series resistance for a given waveform is given by the following calculations. First, the minimum total circuit impedance is found by dividing the impulse generator's peak voltage by the protector's rated current. The impulse generator's fictive impedance (generators peak voltage divided by peak short circuit current) is then subtracted from the minimum total circuit impedance to give the required value of series resistance. In some cases, the equipment will require verification over a temperature range. By using the rated waveform values from Figure 11, the appropriate series resistor value can be calculated for ambient temperatures in the range of -40 °C to 85 °C.

## APPLICATIONS INFORMATION

### AC Power Testing

The protector can withstand currents applied for times not exceeding those shown in Figure 8. Currents that exceed these times must be terminated or reduced to avoid protector failure. Fuses, PTC (Positive Temperature Coefficient) resistors and fusible resistors are overcurrent protection devices which can be used to reduce the current flow. Protective fuses may range from a few hundred milliamperes to one ampere. In some cases, it may be necessary to add some extra series resistance to prevent the fuse opening during impulse testing. The current versus time characteristic of the overcurrent protector must be below the line shown in Figure 8. In some cases, there may be a further time limit imposed by the test standard (e.g. UL 1459 wiring simulator failure).

### Capacitance

The protector characteristic off-state capacitance values are given for d.c. bias voltage,  $V_D$ , values of 0, -1 V, -2 V and -50 V. Where possible, values are also given for -100 V. Values for other voltages may be calculated by multiplying the  $V_D = 0$  capacitance value by the factor given in Figure 6. Up to 10 MHz, the capacitance is essentially independent of frequency. Above 10 MHz, the effective capacitance is strongly dependent on connection inductance. In many applications, such as Figure 15 and Figure 17, the typical conductor bias voltages will be about -2 V and -50 V. Figure 7 shows the differential (line unbalance) capacitance caused by biasing one protector at -2 V and the other at -50 V.

### Normal System Voltage Levels

The protector should not clip or limit the voltages that occur in normal system operation. For unusual conditions, such as ringing without the line connected, some degree of clipping is permissible. Under this condition, about 10 V of clipping is normally possible without activating the ring trip circuit.

Figure 10 allows the calculation of the protector  $V_{DRM}$  value at temperatures below 25 °C. The calculated value should not be less than the maximum normal system voltages. The TISP4265H3BJ, with a  $V_{DRM}$  of 200 V, can be used for the protection of ring generators producing 100 V r.m.s. of ring on a battery voltage of -58 V (Th2 and Th3 in Figure 17). The peak ring voltage will be  $58 + 1.414 \times 100 = 199.4$  V. However, this is the open circuit voltage and the connection of the line, and its equipment will reduce the peak voltage. In the extreme case of an unconnected line, clipping the peak voltage to 190 V should not activate the ring trip. This level of clipping would occur at the temperature when the  $V_{DRM}$  has reduced to  $190/200 = 0.95$  of its 25 °C value. Figure 10 shows that this condition will occur at an ambient temperature of -22 °C. In this example, the TISP4265H3BJ will allow normal equipment operation provided that the minimum expected ambient temperature does not fall below -22 °C.

### JESD51 Thermal Measurement Method

To standardize thermal measurements, the EIA (Electronic Industries Alliance) has created the JESD51 standard. Part 2 of the standard (JESD51-2, 1995) describes the test environment. This is a  $0.0283 \text{ m}^3$  ( $1 \text{ ft}^3$ ) cube which contains the test PCB (Printed Circuit Board) horizontally mounted at the center. Part 3 of the standard (JESD51-3, 1996) defines two test PCBs for surface mount components; one for packages smaller than 27 mm (1.06 ") on a side and the other for packages up to 48 mm (1.89 "). The SMBJ measurements used the smaller 76.2 mm x 114.3 mm (3.0 " x 4.5 ") PCB. The JESD51-3 PCBs are designed to have low effective thermal conductivity (high thermal resistance) and represent a worse case condition. The PCBs used in the majority of applications will achieve lower values of thermal resistance and so can dissipate higher power levels than indicated by the JESD51 values.

## Typical Circuits

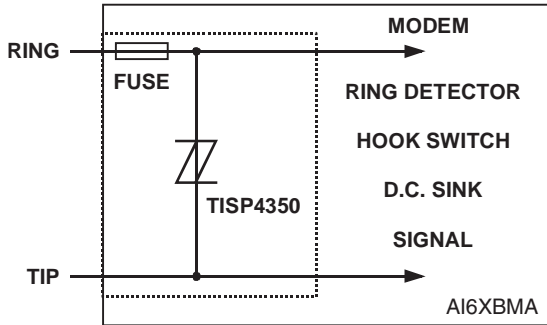

Figure 14. Modem Inter-wire Protection

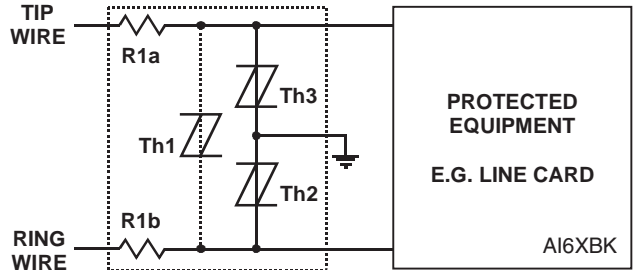

Figure 15. Protection Module

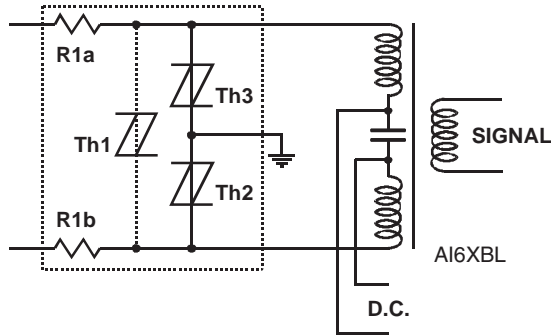

Figure 16. ISDN Protection

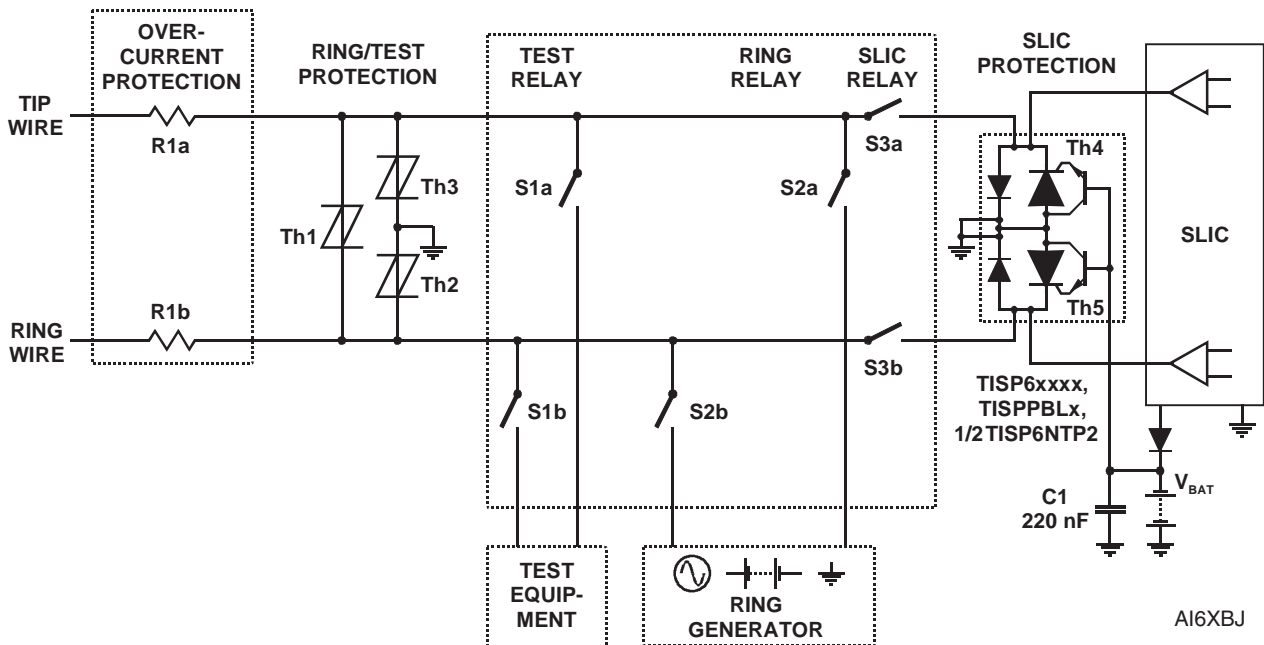
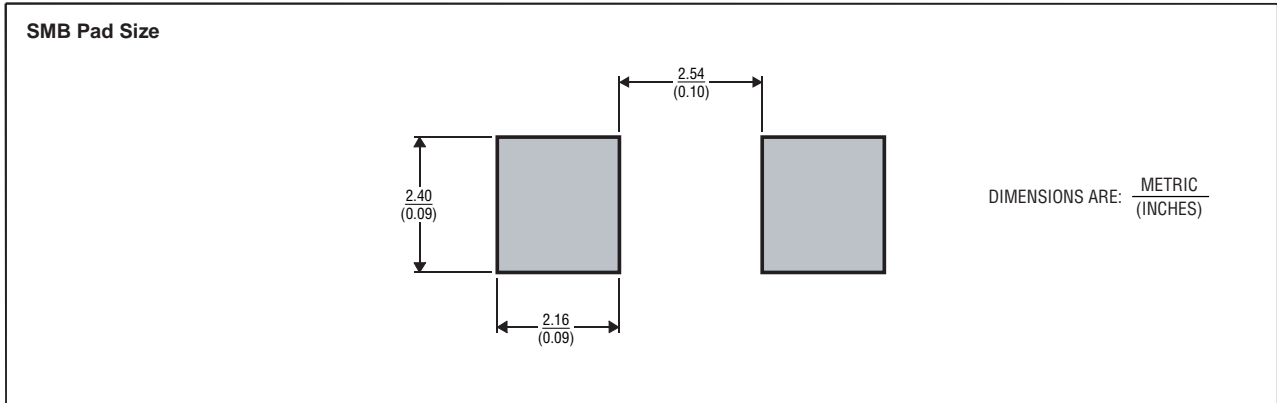

Figure 17. Line Card Ring/Test Protection

## MECHANICAL DATA

### Recommended Printed Wiring Footprint



MDXXBI

### Device Symbolization Code

Devices will be coded as below. As the device parameters are symmetrical, terminal 1 is not identified.

Device	Symbolization Code
TISP4070H3BJ	4070H3
TISP4080H3BJ	4080H3
TISP4095H3BJ	4095H3
TISP4115H3BJ	4115H3
TISP4125H3BJ	4125H3
TISP4145H3BJ	4145H3
TISP4165H3BJ	4165H3
TISP4180H3BJ	4180H3
TISP4200H3BJ	4200H3
TISP4220H3BJ	4220H3
TISP4240H3BJ	4240H3
TISP4250H3BJ	4250H3
TISP4265H3BJ	4265H3
TISP4290H3BJ	4290H3
TISP4300H3BJ	4300H3
TISP4350H3BJ	4350H3
TISP4395H3BJ	4395H3
TISP4400H3BJ	4400H3

### Carrier Information

Devices are shipped in one of the carriers below. Unless a specific method of shipment is specified by the customer, devices will be shipped in the most practical carrier. For production quantities, the carrier will be embossed tape reel pack. Evaluation quantities may be shipped in bulk pack or embossed tape.

Carrier	For Standard Termination Finish Order As	For Lead Free Termination Finish Order As
Embossed Tape Reeled	TISP4xxxH3BJR	TISP4xxxH3BJR-S
Bulk Pack	TISP4xxxH3BJ	TISP4xxxH3BJ-S

NOVEMBER 1997 - REVISED FEBRUARY 2005

Specifications are subject to change without notice.  
Customers should verify actual device performance in their specific applications.

## MECHANICAL DATA

### SMBJ (DO-214AA) Plastic Surface Mount Diode Package

This surface mount package consists of a circuit mounted on a lead frame and encapsulated within a plastic compound. The compound will withstand soldering temperature with no deformation, and circuit performance characteristics will remain stable when operated in high humidity conditions. Leads require no additional cleaning or processing when used in soldered assembly.

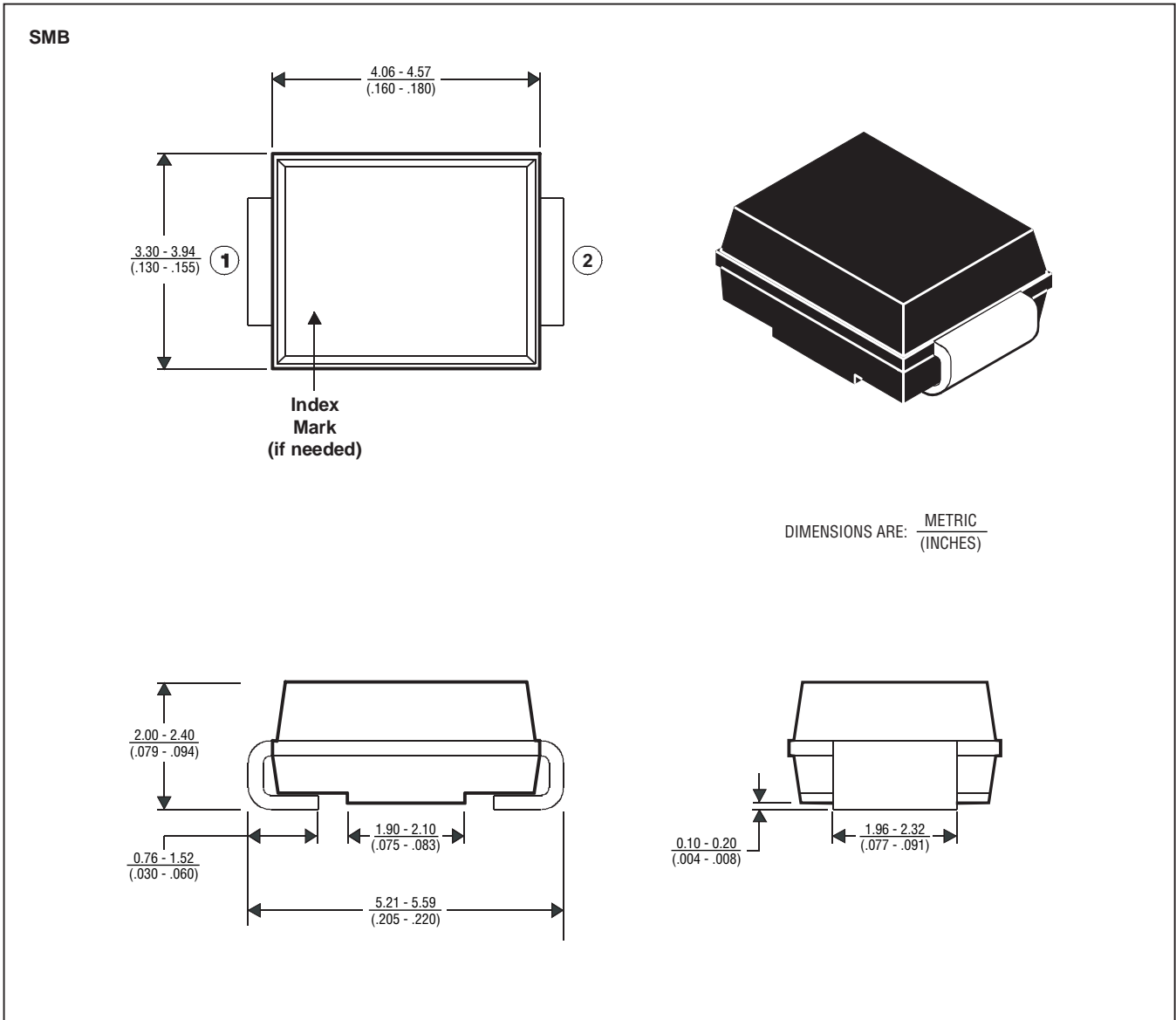

MDXXBHA

## MECHANICAL DATA

### Tape Dimensions

#### SMB Package Single-Sprocket Tape

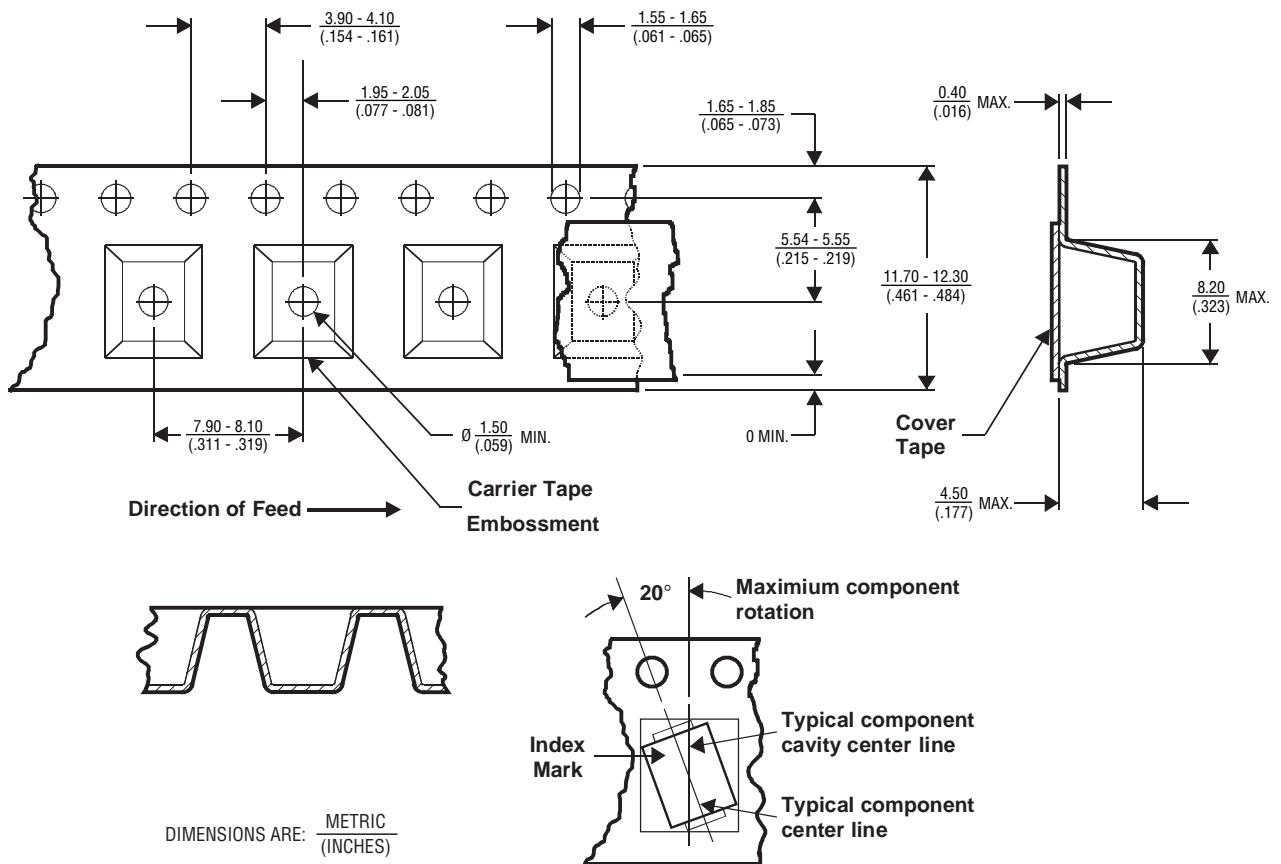

NOTES: A. The clearance between the component and the cavity must be within 0.05 mm (.002 in.) MIN. to 0.65 mm (.026 in.) MAX. so that the component cannot rotate more than 20° within the determined cavity. MDXXBJ

B. Taped devices are supplied on a reel of the following dimensions:-

Reel diameter: 330 ± 3.0 mm (12.99 ± .118 in.)  
 Reel hub diameter: 75 mm (2.95 in.) MIN.  
 Reel axial hole: 13.0 ± 0.5 mm (.512 ± .020 in.)

C. 3000 devices are on a reel.