

- Ultra-Fast Operation . . . 10 ns (typ)
- Low Positive Supply Current
12.7 mA (Typ)
- Operates From a Single 5-V Supply or From a Split ± 5 -V Supply
- Complementary Outputs
- Input Common-Mode Voltage Includes Negative Rail
- Low Offset Voltage
- No Minimum Slew Rate Requirement
- Output Latch Capability
- Functional Replacement to the LT1116

D AND PW PACKAGE
(TOP VIEW)

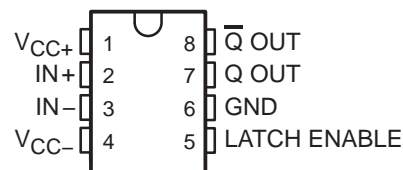

description

The TL3116 is an ultra-fast comparator designed to interface directly to TTL logic while operating from either a single 5-V power supply or dual ± 5 -V supplies. The input common-mode voltage extends to the negative rail for ground sensing applications. It features extremely tight offset voltage and high gain for precision applications. It has complementary outputs that can be latched using the LATCH ENABLE terminal. Figure 1 shows the positive supply current of the comparator. The TL3116 only requires 12.7 mA (typical) to achieve a propagation delay of 10 ns.

The TL3116 is a pin-for-pin functional replacement for the LT1116 comparator, offering high-speed operation but consuming much less power.

symbol (each comparator)

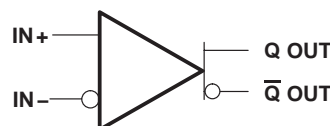

POSITIVE SUPPLY CURRENT
vs
FREE-AIR TEMPERATURE

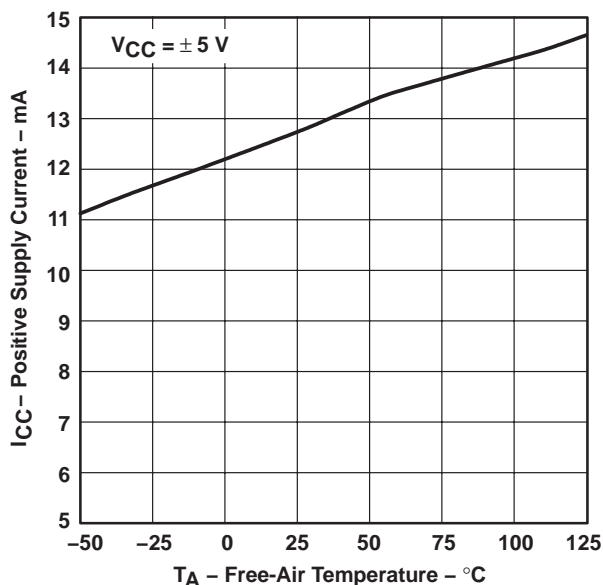

Figure 1

AVAILABLE OPTIONS

T _A	PACKAGED DEVICES		CHIP FORM [‡] (Y)
	SMALL OUTLINE [†] (D)	TSSOP (PW)	
0°C to 70°C	TL3116CD	TL3116CPWLE	TL3116Y
-40°C to 85°C	TL3116ID	TL3116IPWLE	—

[†] The PW packages are available left-ended taped and reeled only.

[‡] Chip forms are tested at T_A = 25°C only.



Please be aware that an important notice concerning availability, standard warranty, and use in critical applications of Texas Instruments semiconductor products and disclaimers thereto appears at the end of this data sheet.

PRODUCTION DATA information is current as of publication date. Products conform to specifications per the terms of Texas Instruments standard warranty. Production processing does not necessarily include testing of all parameters.



TL3116, TL3116Y ULTRA-FAST LOW-POWER PRECISION COMPARATORS

SLCS132C – MARCH 1997 – REVISED MAY 1997

TL3116Y chip information

This chip, when properly assembled, displays characteristics similar to the TL3116C. Thermal compression or ultrasonic bonding may be used on the doped-aluminum bonding pads. Chips may be mounted with conductive epoxy or a gold-silicon preform.

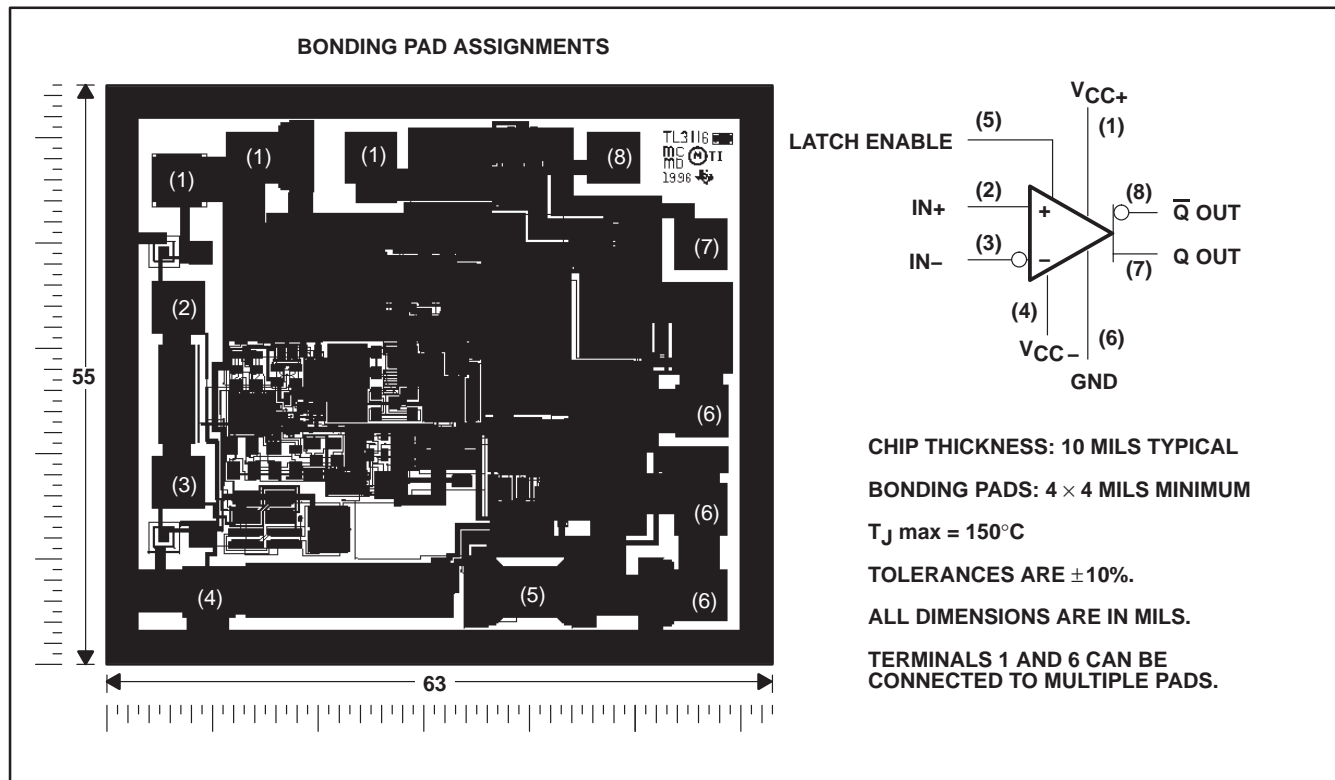

COMPONENT COUNT	
Bipolars	53
MOSFETs	49
Resistors	46
Capacitors	14

absolute maximum ratings over operating free-air temperature range (unless otherwise noted)†

Supply voltage, V_{DD} (see Note 1)	– 7 V to 7 V
Differential input voltage, V_{ID} (see Note 2)	7 V
Input voltage range, V_I	7 V
Input voltage, V_I (LATCH ENABLE)	7 V
Output current, I_O	± 20 mA
Continuous total power dissipation	See Dissipation Rating Table
Operating free-air temperature range, T_A	–40°C to 85°C
Storage temperature range, T_{stg}	– 65°C to 150°C
Lead temperature 1,6 mm (1/16 inch) from case for 10 seconds	260°C

† Stresses beyond those listed under “absolute maximum ratings” may cause permanent damage to the device. These are stress ratings only, and functional operation of the device at these or any other conditions beyond those indicated under “recommended operating conditions” is not implied. Exposure to absolute-maximum-rated conditions for extended periods may affect device reliability.

- NOTES: 1. All voltage values, except differential voltages, are with respect to network ground.
 2. Differential voltages are at IN+ with respect to IN–.

DISSIPATION RATING TABLE

PACKAGE	$T_A \leq 25^\circ\text{C}$ POWER RATING	DERATING FACTOR ABOVE $T_A = 25^\circ\text{C}$	$T_A = 70^\circ\text{C}$ POWER RATING
D	725 mW	5.8 mW/°C	464 mW
PW	525 mW	4.2 mW/°C	336 mW

TL3116, TL3116Y

ULTRA-FAST LOW-POWER PRECISION COMPARATORS

SLCS132C – MARCH 1997 – REVISED MAY 1997

electrical characteristics at specified operating free-air temperature, $V_{DD} = \pm 5\text{ V}$, $V_{LE} = 0$ (unless otherwise noted)

PARAMETER		TEST CONDITION†	TL3116C			TL3116I			UNIT
			MIN	TYP‡	MAX	MIN	TYP‡	MAX	
V_{IO}	Input offset voltage	$T_A = 25^\circ\text{C}$		0.5	3		0.5	3	mV
		$T_A = \text{full range}$			3.5			3.5	
α_{VIO}	Temperature coefficient of input offset voltage			-2.5			-2.8	$\mu\text{V}/^\circ\text{C}$	
I_{IO}	Input offset current	$T_A = 25^\circ\text{C}$		0.1	0.2		0.1	0.2	μA
		$T_A = \text{full range}$			0.3			0.35	
I_{IB}	Input bias current	$T_A = 25^\circ\text{C}$		0.7	1.1		0.7	1.1	μA
		$T_A = \text{full range}$			1.2			1.5	
V_{ICR}	Common-mode input voltage range	$V_{DD} = \pm 5\text{ V}$	-5		2.5	-5		2.5	V
		$V_{DD} = 5\text{ V}$	0		2.5	0		2.5	
CMRR	Common-mode rejection ratio	$-5 \leq V_{IC} \leq 2.5\text{ V}$	75	100		75	100	dB	
k_{SVR}	Supply-voltage rejection ratio	Positive supply: $4.6\text{ V} \leq +V_{DD} \leq 5.4\text{ V}$, $T_A = 25^\circ\text{C}$	60	80		60	80	dB	
		Negative supply: $-7\text{ V} \leq -V_{DD} \leq -2\text{ V}$, $T_A = 25^\circ\text{C}$	80	100		80	100		
V_{OL}	Low-level output voltage	$I_{(\text{sink})} = 4\text{ mA}$, $T_A = 25^\circ\text{C}$, $V_+ \leq 4.6\text{ V}$		400	600		400	600	mV
		$I_{(\text{sink})} = 10\text{ mA}$, $T_A = 25^\circ\text{C}$, $V_+ \leq 4.6\text{ V}$		750			750		
V_{OH}	High-level output voltage	$V_+ \leq 4.6\text{ V}$, $T_A = 25^\circ\text{C}$, $I_O = 1\text{ mA}$	3.6	3.9		3.6	3.9	V	
		$V_+ \leq 4.6\text{ V}$, $T_A = 25^\circ\text{C}$, $I_O = 10\text{ mA}$	3.4	3.8		3.4	3.8		
I_{CC}	Positive supply current	$T_A = \text{full range}$		12.7	14.7		12.7	15	mA
	Negative supply current			-2.6			-3		
V_{IL}	Low-level input voltage (LATCH ENABLE)			0.8			0.8	V	
V_{IH}	High-level input voltage (LATCH ENABLE)		2			2		V	
I_{IL}	Low-level input current (LATCH ENABLE)	$V_{LE} = 0$		0	1		0	1	μA
		$V_{LE} = 2\text{ V}$		24	39		24	45	μA

† Full range for the TL3116C is $T_A = 0^\circ\text{C}$ to 70°C . Full range for the TL3116I is $T_A = -40^\circ\text{C}$ to 85°C .

‡ All typical values are measures with $T_A = 25^\circ\text{C}$.



switching characteristics, $V_{DD} = \pm 5\text{ V}$, $V_{LE} = 0$

PARAMETER	TEST CONDITION [†]		TL3116C			TL3116I			UNIT
			MIN	TYP	MAX	MIN	TYP	MAX	
t_{pd1} Propagation delay time [‡]	$\Delta V_I = 100\text{ mV}$, $V_{OD} = 5\text{ mV}$	$T_A = 25^\circ\text{C}$	9.9	12		9.9	12	ns	
		$T_A = \text{full range}$	9.9	14		9.9	15		
	$\Delta V_I = 100\text{ mV}$, $V_{OD} = 20\text{ mV}$	$T_A = 25^\circ\text{C}$	8.2	10.3		8.2	10.3		
		$T_A = \text{full range}$	8.2	12.7		8.2	13.7		
$t_{sk(p)}$ Pulse skew ($t_{pd+} - t_{pd-}$)	$\Delta V_I = 100\text{ mV}$, $T_A = 25^\circ\text{C}$	$V_{OD} = 5\text{ mV}$	0.5			0.5	ns		
t_{su} Setup time, LATCH ENABLE			3.4			3.4	ns		

[†] Full range for the TL3116C is 0°C to 70°C. Full range for the TL3116I is -40°C to 85°C.

[‡] t_{pd1} cannot be measured in automatic handling equipment with low values of overdrive. The TL3116 is 100% tested with a 1-V step and 500-mV overdrive at $T_A = 25^\circ\text{C}$ only. Correlation tests have shown that t_{pd1} limits given can be ensured with this test, if additional dc tests are performed to ensure that all internal bias conditions are correct. For low overdrive conditions, V_{OS} is added to the overdrive.

TYPICAL CHARACTERISTICS

Table of Graphs

		FIGURE	
I_{CC}	Positive supply current	vs Input voltage	2
		vs Frequency	3
		vs Free-air temperature	4
I_{CC}	Negative supply current	vs Free-air temperature	5
t_{pd}	Propagation delay time	vs Overdrive voltage	6
		vs Supply voltage	7
		vs Input impedance	8
		vs Load capacitance	9
		vs Free-air temperature	10
V_{IC}	Common-mode input voltage	vs Free-air temperature	11
V_{IT}	Input threshold voltage (LATCH ENABLE)	vs Free-air temperature	12
V_O	Output voltage	vs Output source current	13
		vs Output sink current	14
I_I	Input current (LATCH ENABLE)	vs Input voltage	15

TYPICAL CHARACTERISTICS

**POSITIVE SUPPLY CURRENT
 vs
 INPUT VOLTAGE**

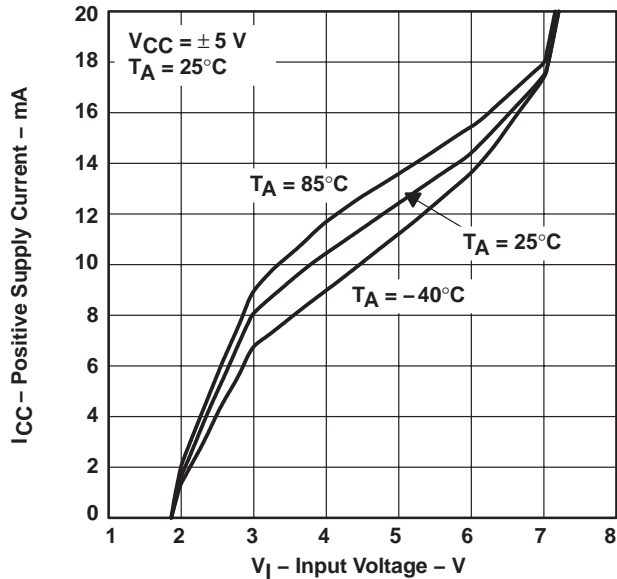

Figure 2

**POSITIVE SUPPLY CURRENT
 vs
 FREQUENCY**

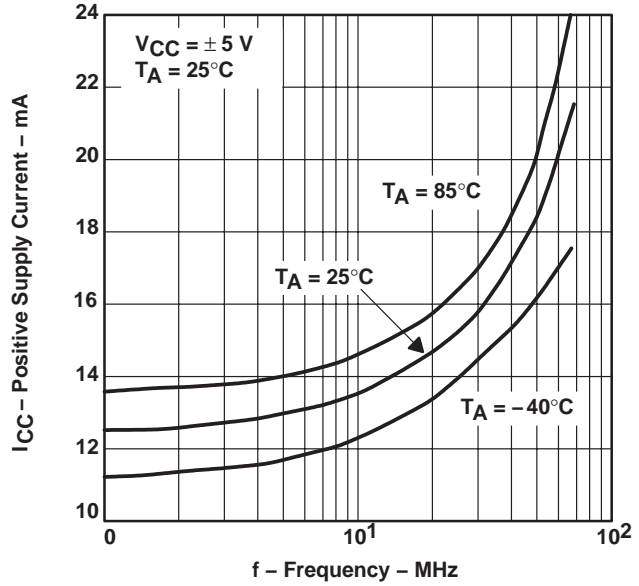

Figure 3

**POSITIVE SUPPLY CURRENT
 vs
 FREE-AIR TEMPERATURE**

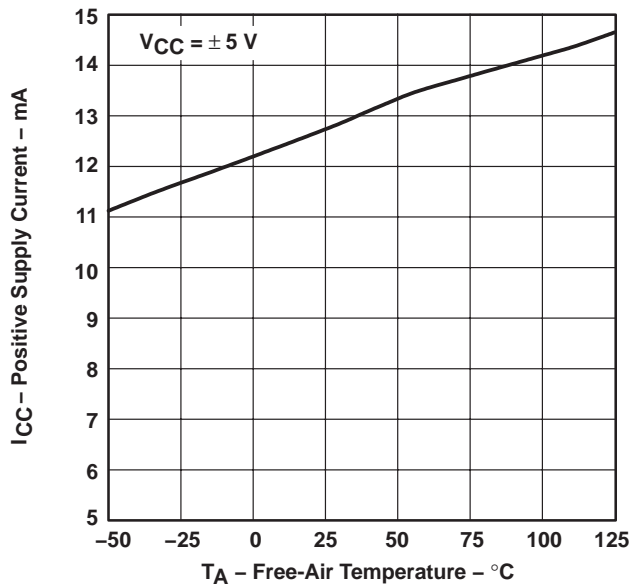

Figure 4

**NEGATIVE SUPPLY CURRENT
 vs
 FREE-AIR TEMPERATURE**

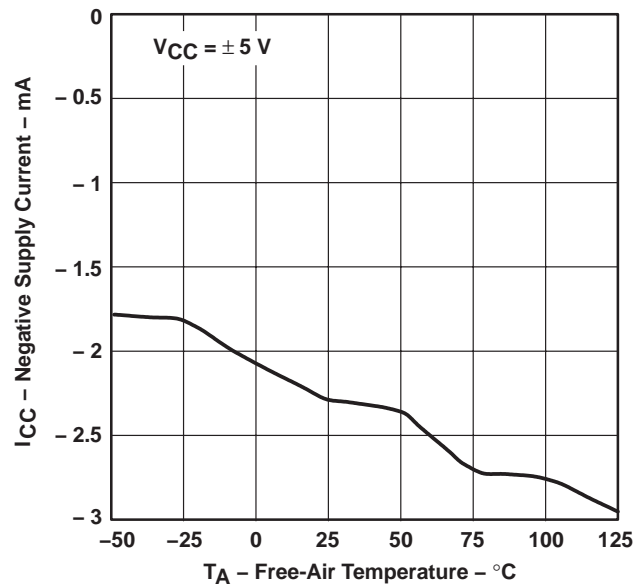

Figure 5

TYPICAL CHARACTERISTICS

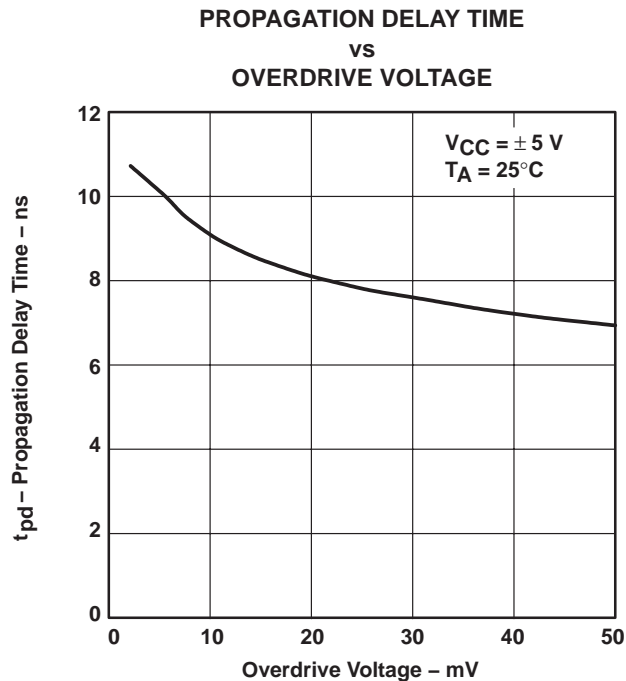

Figure 6

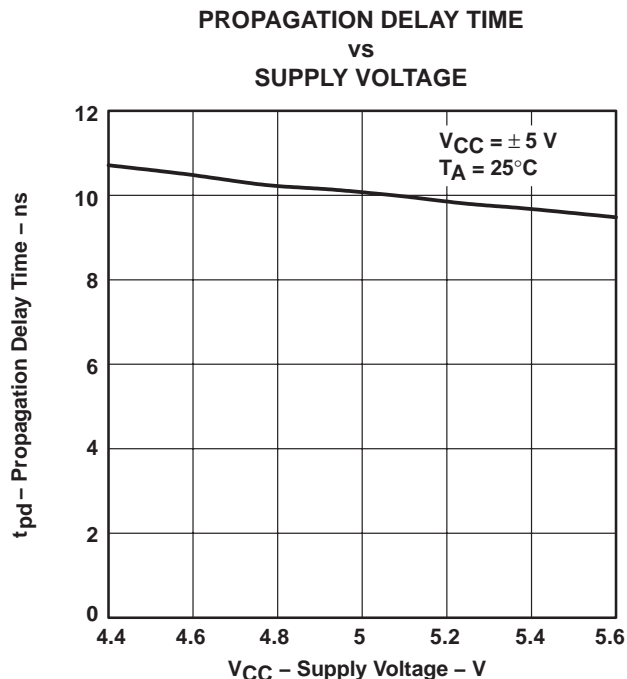

Figure 7

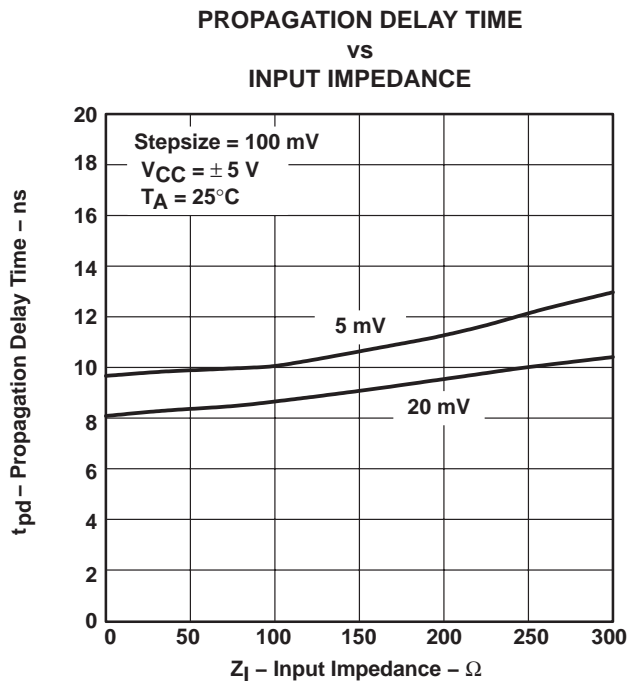

Figure 8

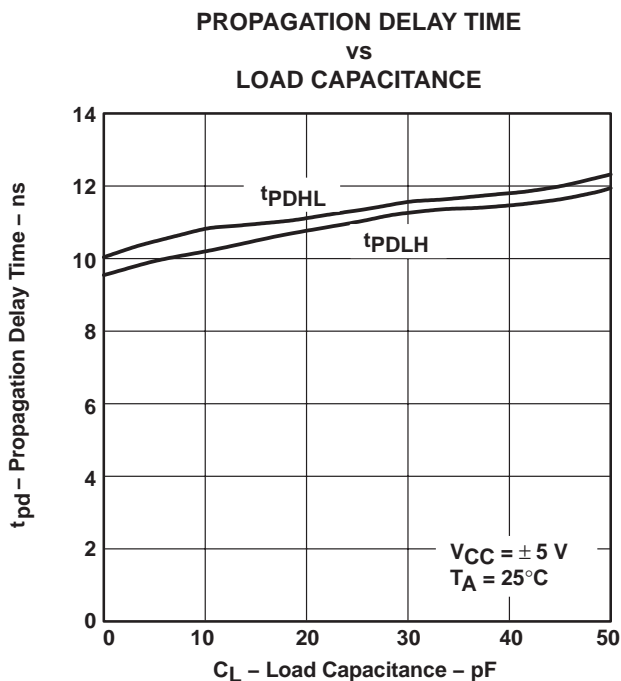

Figure 9

TYPICAL CHARACTERISTICS

PROPAGATION DELAY TIME
vs
FREE-AIR TEMPERATURE

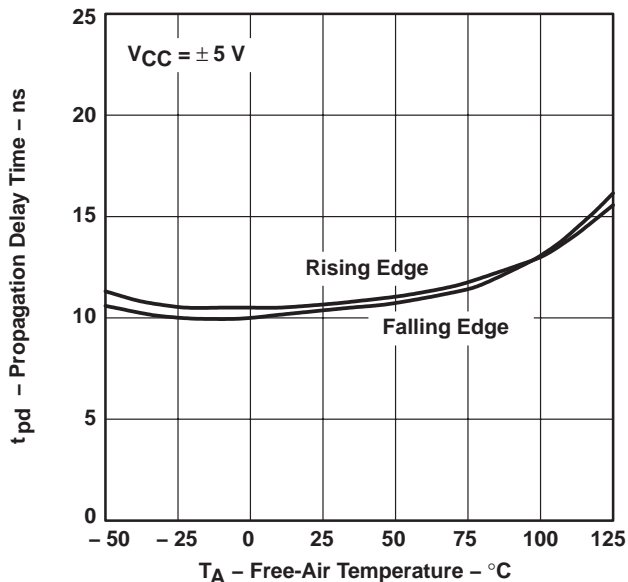

Figure 10

COMMON-MODE INPUT VOLTAGE
vs
FREE-AIR TEMPERATURE

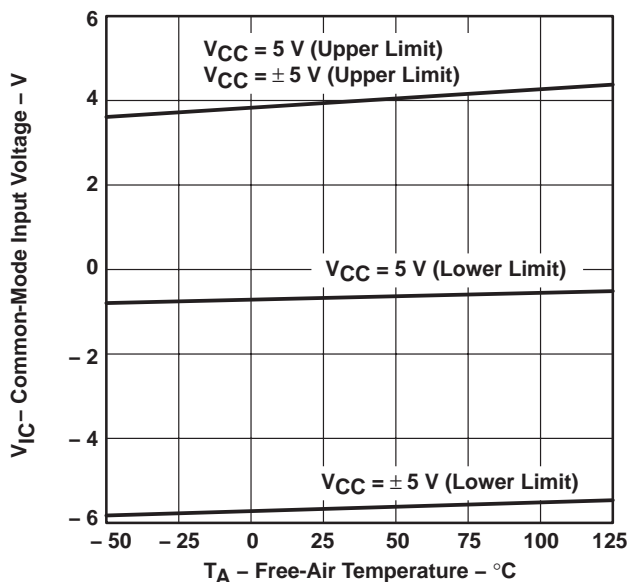

Figure 11

INPUT THRESHOLD VOLTAGE (LATCH ENABLE)
vs
FREE-AIR TEMPERATURE

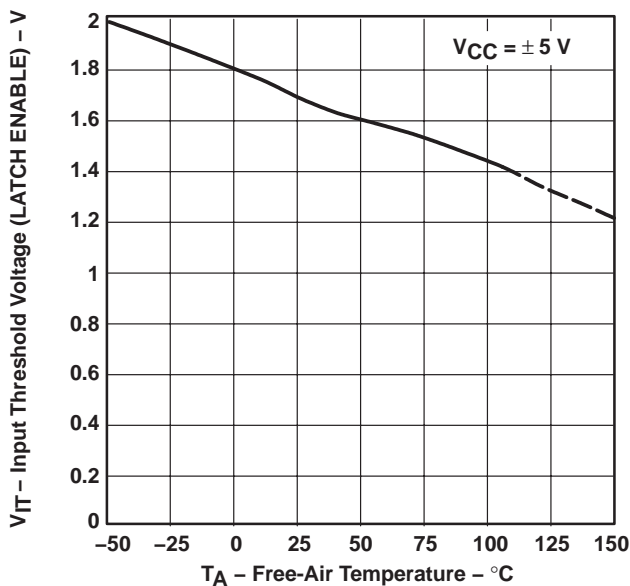

Figure 12

OUTPUT VOLTAGE
vs
OUTPUT SOURCE CURRENT

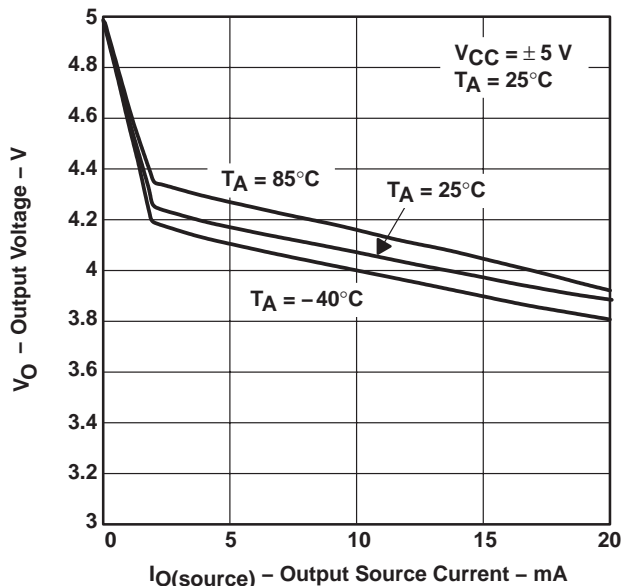

Figure 13

TYPICAL CHARACTERISTICS

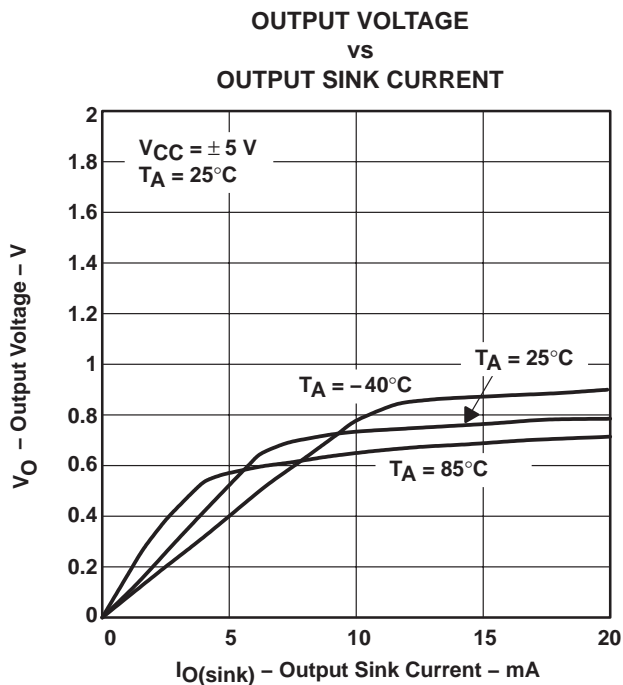

Figure 14

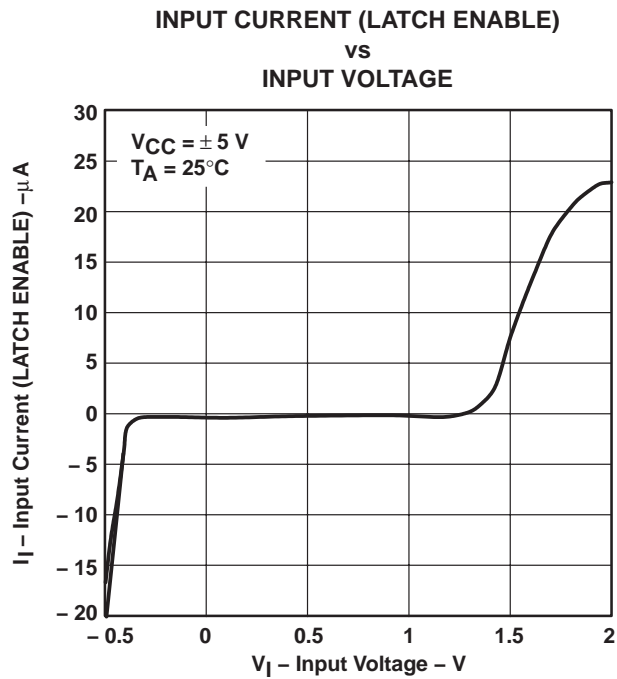

Figure 15

TL3116, TL3116Y
ULTRA-FAST LOW-POWER
PRECISION COMPARATORS

SLCS132C – MARCH 1997 – REVISED MAY 1997

MECHANICAL INFORMATION

D (R-PDSO-G)**

PLASTIC SMALL-OUTLINE PACKAGE

14 PIN SHOWN

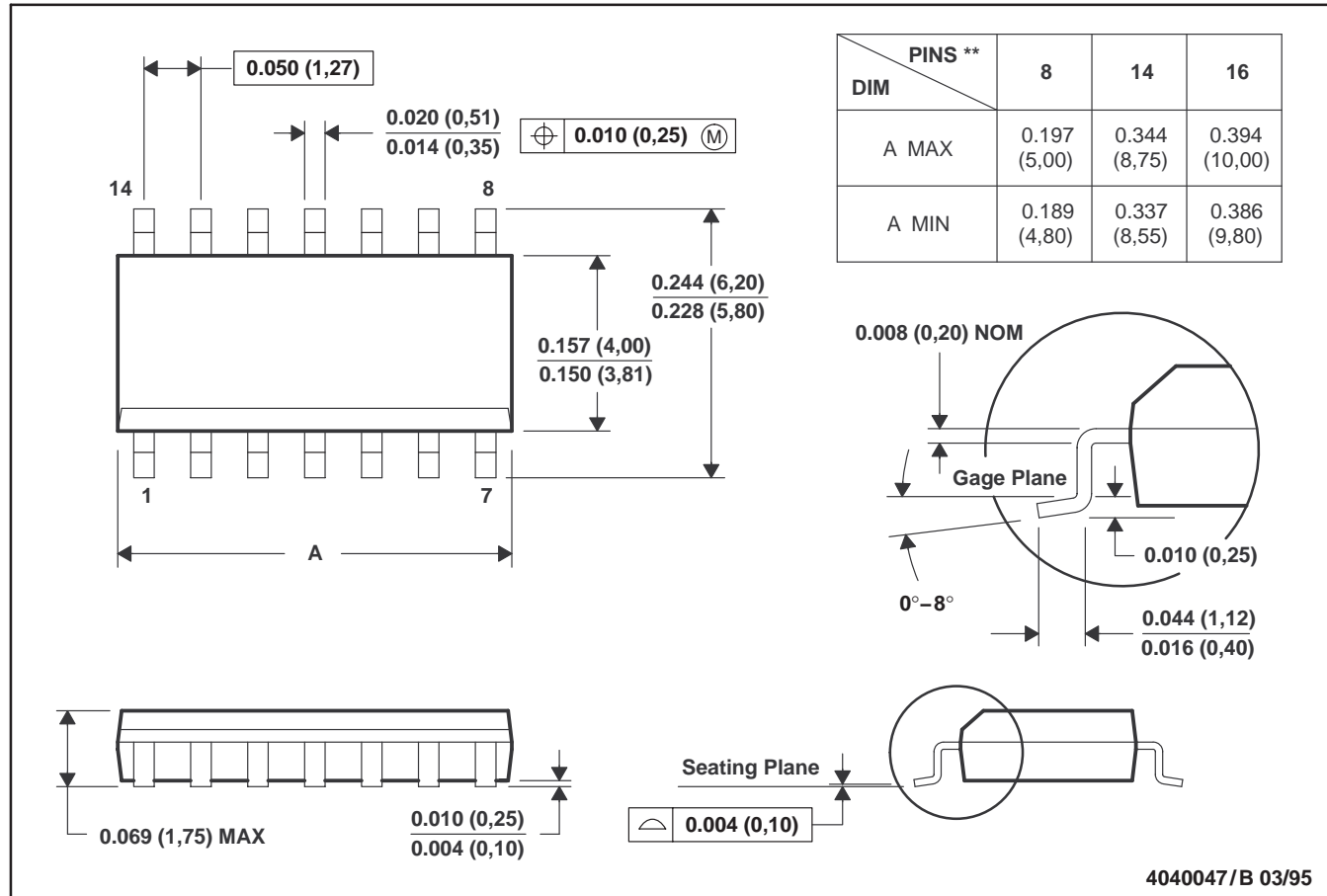

- NOTES: A. All linear dimensions are in inches (millimeters).
 B. This drawing is subject to change without notice.
 C. Body dimensions do not include mold flash or protrusion, not to exceed 0.006 (0,15).
 D. Four center pins are connected to die mount pad.
 E. Falls within JEDEC MS-012

MECHANICAL INFORMATION

PW (R-PDSO-G)**

PLASTIC SMALL-OUTLINE PACKAGE

14 PIN SHOWN

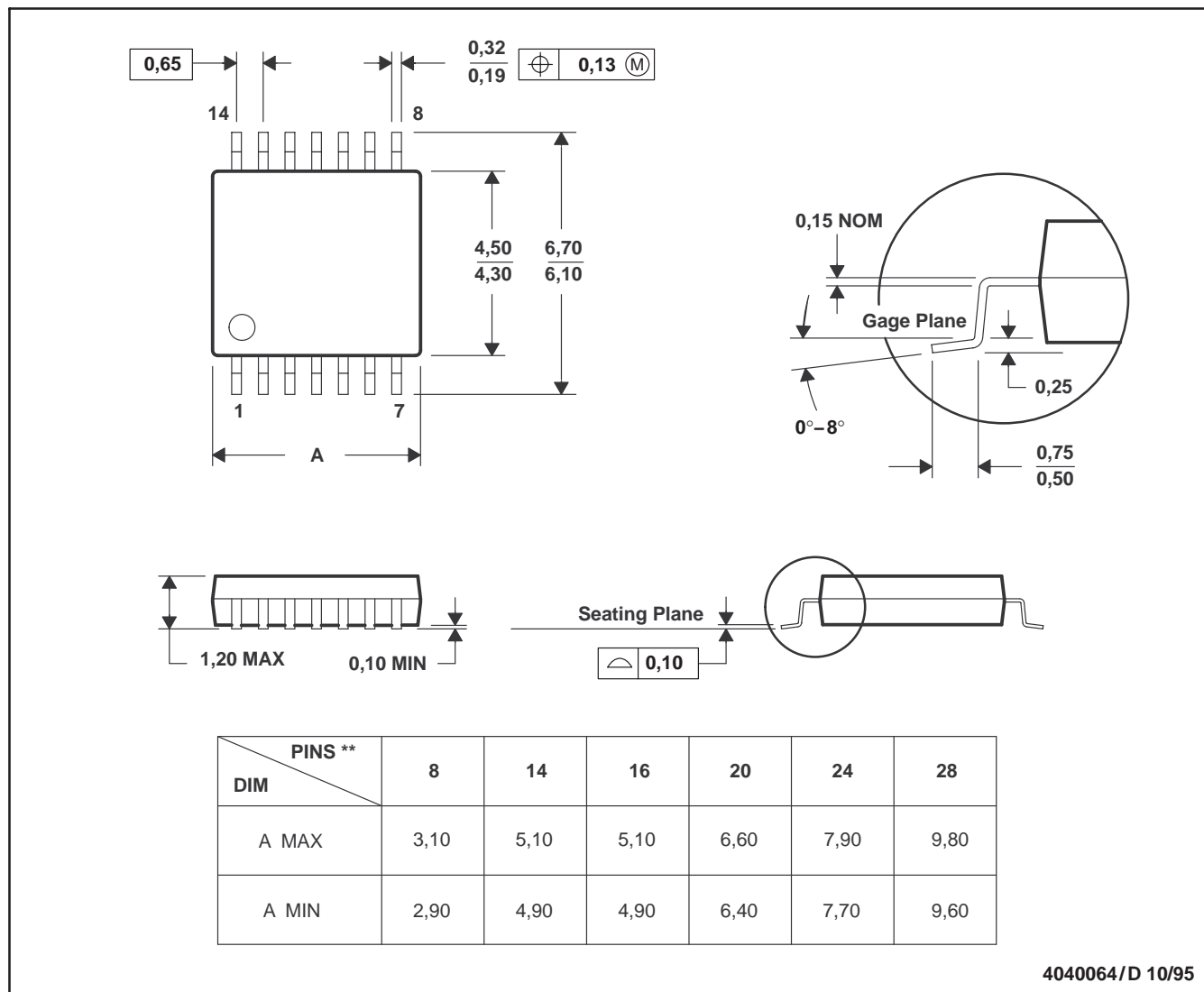

4040064/D 10/95

- NOTES: A. All linear dimensions are in millimeters.
 B. This drawing is subject to change without notice.
 C. Body dimensions do not include mold flash or protrusion not to exceed 0,15.
 D. Falls within JEDEC MO-153

PACKAGING INFORMATION

Orderable Device	Status ⁽¹⁾	Package Type	Package Drawing	Pins	Package Qty	Eco Plan ⁽²⁾	Lead/Ball Finish	MSL Peak Temp ⁽³⁾
TL3116CD	ACTIVE	SOIC	D	8	75	Green (RoHS & no Sb/Br)	CU NIPDAU	Level-1-260C-UNLIM
TL3116CDG4	ACTIVE	SOIC	D	8	75	Green (RoHS & no Sb/Br)	CU NIPDAU	Level-1-260C-UNLIM
TL3116CDR	ACTIVE	SOIC	D	8	2500	Green (RoHS & no Sb/Br)	CU NIPDAU	Level-1-260C-UNLIM
TL3116CDRG4	ACTIVE	SOIC	D	8	2500	Green (RoHS & no Sb/Br)	CU NIPDAU	Level-1-260C-UNLIM
TL3116CPW	ACTIVE	TSSOP	PW	8	150	Green (RoHS & no Sb/Br)	CU NIPDAU	Level-1-260C-UNLIM
TL3116CPWG4	ACTIVE	TSSOP	PW	8	150	Green (RoHS & no Sb/Br)	CU NIPDAU	Level-1-260C-UNLIM
TL3116CPWLE	OBSOLETE	TSSOP	PW	8		TBD	Call TI	Call TI
TL3116CPWR	ACTIVE	TSSOP	PW	8	2000	Green (RoHS & no Sb/Br)	CU NIPDAU	Level-1-260C-UNLIM
TL3116CPWRG4	ACTIVE	TSSOP	PW	8	2000	Green (RoHS & no Sb/Br)	CU NIPDAU	Level-1-260C-UNLIM
TL3116ID	ACTIVE	SOIC	D	8	75	Green (RoHS & no Sb/Br)	CU NIPDAU	Level-1-260C-UNLIM
TL3116IDG4	ACTIVE	SOIC	D	8	75	Green (RoHS & no Sb/Br)	CU NIPDAU	Level-1-260C-UNLIM
TL3116IDR	ACTIVE	SOIC	D	8	2500	Green (RoHS & no Sb/Br)	CU NIPDAU	Level-1-260C-UNLIM
TL3116IDRG4	ACTIVE	SOIC	D	8	2500	Green (RoHS & no Sb/Br)	CU NIPDAU	Level-1-260C-UNLIM
TL3116IPW	ACTIVE	TSSOP	PW	8	150	Green (RoHS & no Sb/Br)	CU NIPDAU	Level-1-260C-UNLIM
TL3116IPWG4	ACTIVE	TSSOP	PW	8	150	Green (RoHS & no Sb/Br)	CU NIPDAU	Level-1-260C-UNLIM
TL3116IPWLE	OBSOLETE	TSSOP	PW	8		TBD	Call TI	Call TI
TL3116IPWR	ACTIVE	TSSOP	PW	8	2000	Green (RoHS & no Sb/Br)	CU NIPDAU	Level-1-260C-UNLIM
TL3116IPWRG4	ACTIVE	TSSOP	PW	8	2000	Green (RoHS & no Sb/Br)	CU NIPDAU	Level-1-260C-UNLIM

⁽¹⁾ The marketing status values are defined as follows:

ACTIVE: Product device recommended for new designs.

LIFEBUY: TI has announced that the device will be discontinued, and a lifetime-buy period is in effect.

NRND: Not recommended for new designs. Device is in production to support existing customers, but TI does not recommend using this part in a new design.

PREVIEW: Device has been announced but is not in production. Samples may or may not be available.

OBSOLETE: TI has discontinued the production of the device.

⁽²⁾ Eco Plan - The planned eco-friendly classification: Pb-Free (RoHS), Pb-Free (RoHS Exempt), or Green (RoHS & no Sb/Br) - please check <http://www.ti.com/productcontent> for the latest availability information and additional product content details.

TBD: The Pb-Free/Green conversion plan has not been defined.

Pb-Free (RoHS): TI's terms "Lead-Free" or "Pb-Free" mean semiconductor products that are compatible with the current RoHS requirements for all 6 substances, including the requirement that lead not exceed 0.1% by weight in homogeneous materials. Where designed to be soldered at high temperatures, TI Pb-Free products are suitable for use in specified lead-free processes.

Pb-Free (RoHS Exempt): This component has a RoHS exemption for either 1) lead-based flip-chip solder bumps used between the die and package, or 2) lead-based die adhesive used between the die and leadframe. The component is otherwise considered Pb-Free (RoHS compatible) as defined above.

Green (RoHS & no Sb/Br): TI defines "Green" to mean Pb-Free (RoHS compatible), and free of Bromine (Br) and Antimony (Sb) based flame retardants (Br or Sb do not exceed 0.1% by weight in homogeneous material)

⁽³⁾ MSL, Peak Temp. -- The Moisture Sensitivity Level rating according to the JEDEC industry standard classifications, and peak solder temperature.

Important Information and Disclaimer:The information provided on this page represents TI's knowledge and belief as of the date that it is provided. TI bases its knowledge and belief on information provided by third parties, and makes no representation or warranty as to the accuracy of such information. Efforts are underway to better integrate information from third parties. TI has taken and continues to take reasonable steps to provide representative and accurate information but may not have conducted destructive testing or chemical analysis on incoming materials and chemicals. TI and TI suppliers consider certain information to be proprietary, and thus CAS numbers and other limited information may not be available for release.

In no event shall TI's liability arising out of such information exceed the total purchase price of the TI part(s) at issue in this document sold by TI to Customer on an annual basis.

TAPE AND REEL INFORMATION



QUADRANT ASSIGNMENTS FOR PIN 1 ORIENTATION IN TAPE

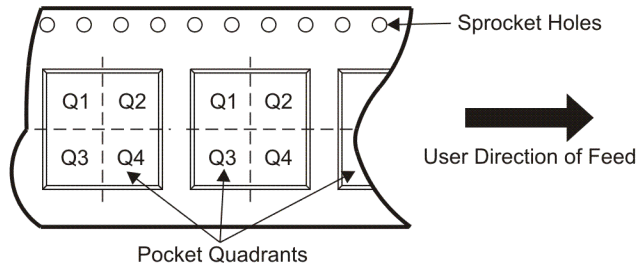

*All dimensions are nominal

Device	Package Type	Package Drawing	Pins	SPQ	Reel Diameter (mm)	Reel Width W1 (mm)	A0 (mm)	B0 (mm)	K0 (mm)	P1 (mm)	W (mm)	Pin1 Quadrant
TL3116CDR	SOIC	D	8	2500	330.0	12.4	6.4	5.2	2.1	8.0	12.0	Q1
TL3116CPWR	TSSOP	PW	8	2000	330.0	12.4	7.0	3.6	1.6	8.0	12.0	Q1
TL3116IDR	SOIC	D	8	2500	330.0	12.4	6.4	5.2	2.1	8.0	12.0	Q1
TL3116IPWR	TSSOP	PW	8	2000	330.0	12.4	7.0	3.6	1.6	8.0	12.0	Q1

TAPE AND REEL BOX DIMENSIONS

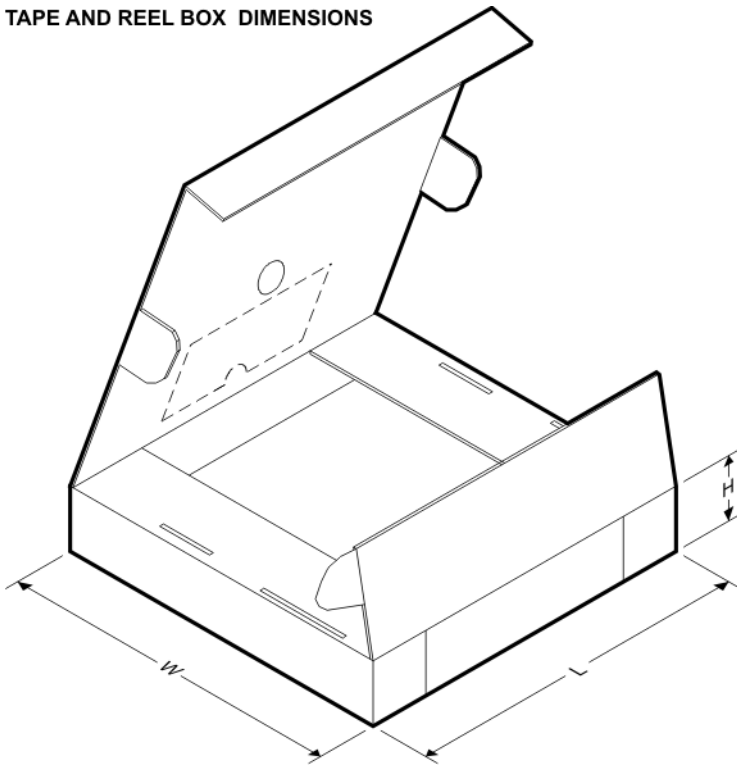

*All dimensions are nominal

Device	Package Type	Package Drawing	Pins	SPQ	Length (mm)	Width (mm)	Height (mm)
TL3116CDR	SOIC	D	8	2500	346.0	346.0	29.0
TL3116CPWR	TSSOP	PW	8	2000	346.0	346.0	29.0
TL3116IDR	SOIC	D	8	2500	346.0	346.0	29.0
TL3116IPWR	TSSOP	PW	8	2000	346.0	346.0	29.0

PW (R-PDSO-G**)

PLASTIC SMALL-OUTLINE PACKAGE

14 PINS SHOWN

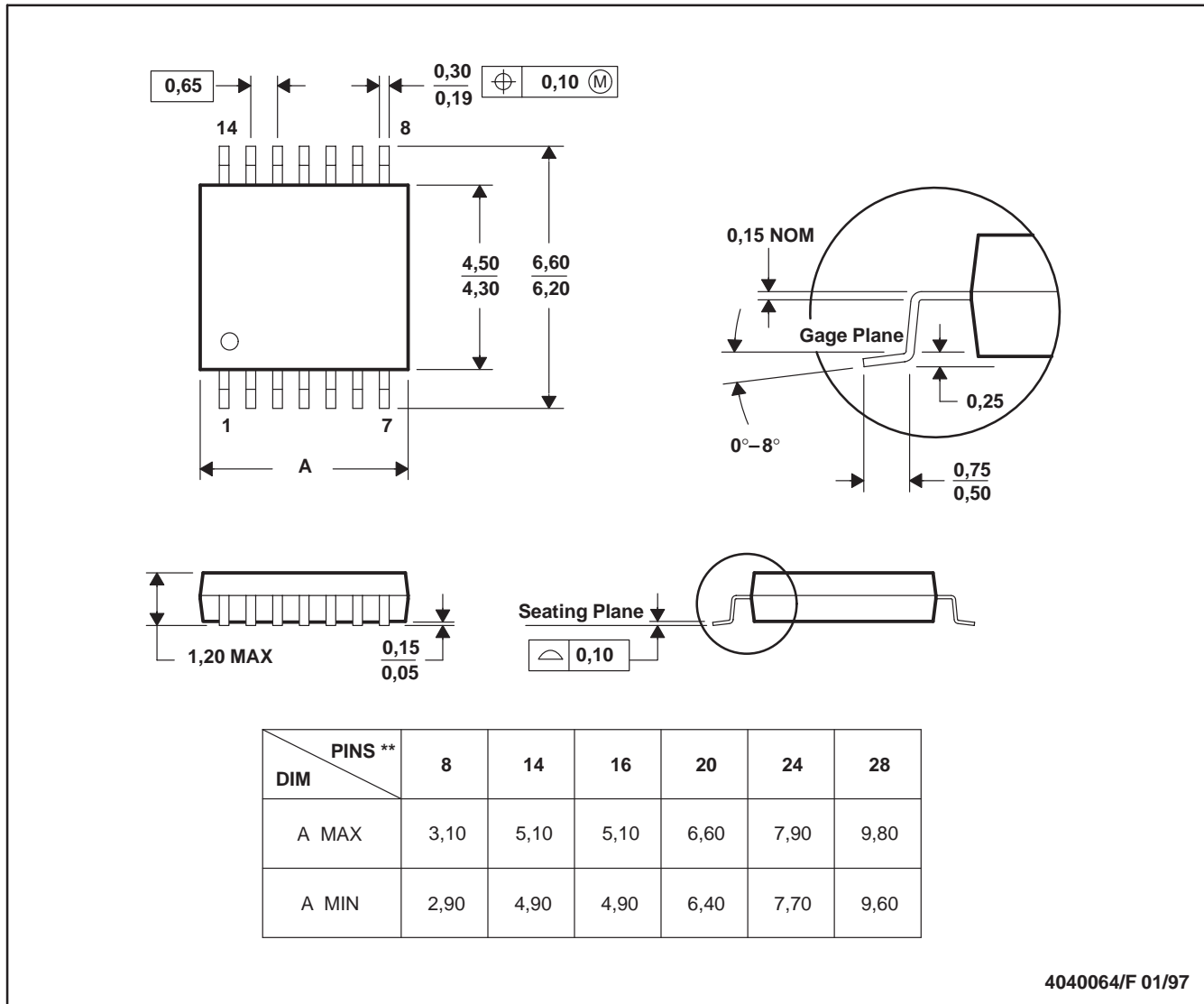

4040064/F 01/97

- NOTES: A. All linear dimensions are in millimeters.
 B. This drawing is subject to change without notice.
 C. Body dimensions do not include mold flash or protrusion not to exceed 0,15.
 D. Falls within JEDEC MO-153

D (R-PDSO-G8)

PLASTIC SMALL-OUTLINE PACKAGE

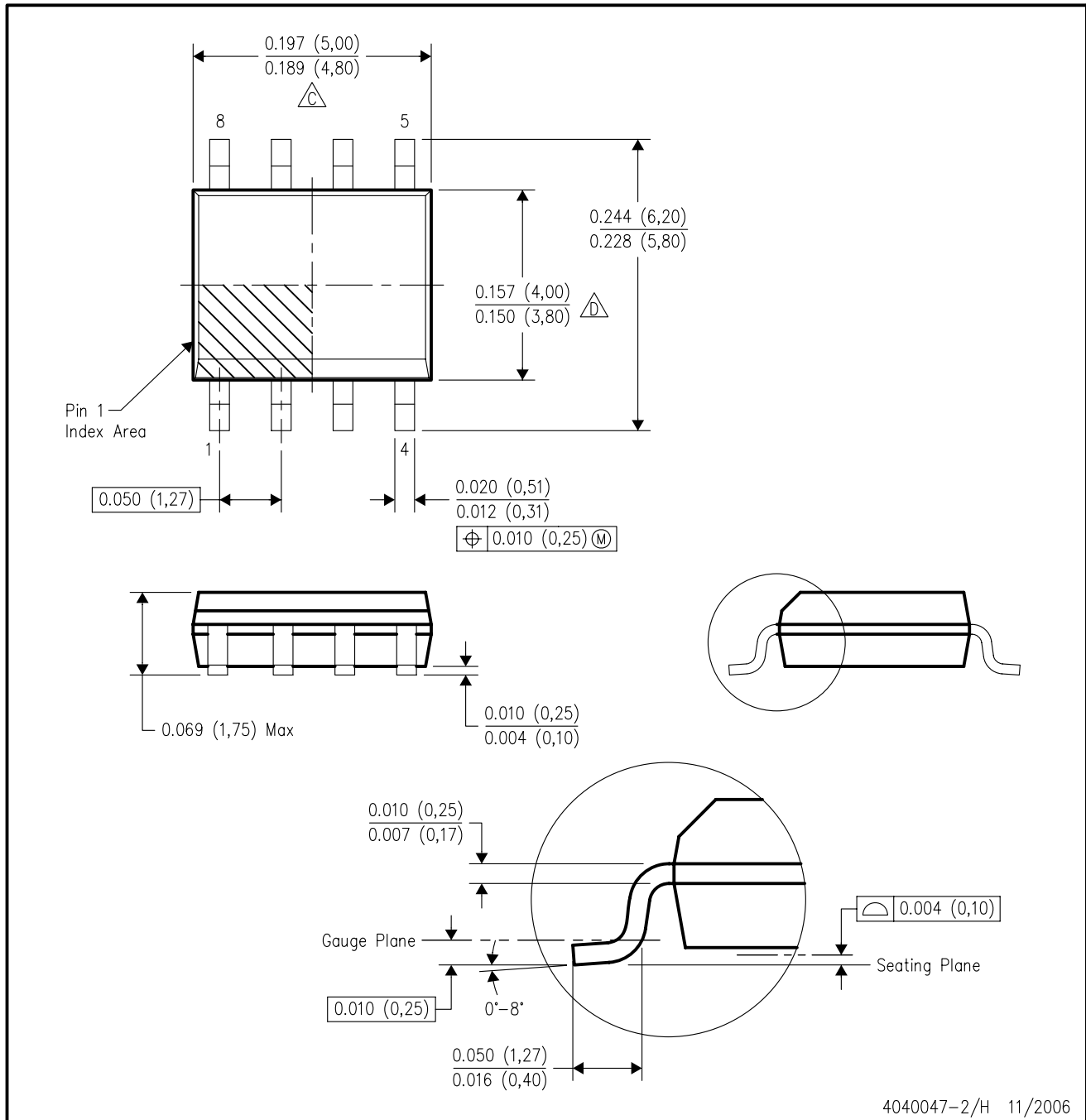

- NOTES:
- A. All linear dimensions are in inches (millimeters).
 - B. This drawing is subject to change without notice.
 - C. Body length does not include mold flash, protrusions, or gate burrs. Mold flash, protrusions, or gate burrs shall not exceed .006 (0,15) per end.
 - D. Body width does not include interlead flash. Interlead flash shall not exceed .017 (0,43) per side.
 - E. Reference JEDEC MS-012 variation AA.

IMPORTANT NOTICE

Texas Instruments Incorporated and its subsidiaries (TI) reserve the right to make corrections, modifications, enhancements, improvements, and other changes to its products and services at any time and to discontinue any product or service without notice. Customers should obtain the latest relevant information before placing orders and should verify that such information is current and complete. All products are sold subject to TI's terms and conditions of sale supplied at the time of order acknowledgment.

TI warrants performance of its hardware products to the specifications applicable at the time of sale in accordance with TI's standard warranty. Testing and other quality control techniques are used to the extent TI deems necessary to support this warranty. Except where mandated by government requirements, testing of all parameters of each product is not necessarily performed.

TI assumes no liability for applications assistance or customer product design. Customers are responsible for their products and applications using TI components. To minimize the risks associated with customer products and applications, customers should provide adequate design and operating safeguards.

TI does not warrant or represent that any license, either express or implied, is granted under any TI patent right, copyright, mask work right, or other TI intellectual property right relating to any combination, machine, or process in which TI products or services are used. Information published by TI regarding third-party products or services does not constitute a license from TI to use such products or services or a warranty or endorsement thereof. Use of such information may require a license from a third party under the patents or other intellectual property of the third party, or a license from TI under the patents or other intellectual property of TI.

Reproduction of TI information in TI data books or data sheets is permissible only if reproduction is without alteration and is accompanied by all associated warranties, conditions, limitations, and notices. Reproduction of this information with alteration is an unfair and deceptive business practice. TI is not responsible or liable for such altered documentation. Information of third parties may be subject to additional restrictions.

Resale of TI products or services with statements different from or beyond the parameters stated by TI for that product or service voids all express and any implied warranties for the associated TI product or service and is an unfair and deceptive business practice. TI is not responsible or liable for any such statements.

TI products are not authorized for use in safety-critical applications (such as life support) where a failure of the TI product would reasonably be expected to cause severe personal injury or death, unless officers of the parties have executed an agreement specifically governing such use. Buyers represent that they have all necessary expertise in the safety and regulatory ramifications of their applications, and acknowledge and agree that they are solely responsible for all legal, regulatory and safety-related requirements concerning their products and any use of TI products in such safety-critical applications, notwithstanding any applications-related information or support that may be provided by TI. Further, Buyers must fully indemnify TI and its representatives against any damages arising out of the use of TI products in such safety-critical applications.

TI products are neither designed nor intended for use in military/aerospace applications or environments unless the TI products are specifically designated by TI as military-grade or "enhanced plastic." Only products designated by TI as military-grade meet military specifications. Buyers acknowledge and agree that any such use of TI products which TI has not designated as military-grade is solely at the Buyer's risk, and that they are solely responsible for compliance with all legal and regulatory requirements in connection with such use.

TI products are neither designed nor intended for use in automotive applications or environments unless the specific TI products are designated by TI as compliant with ISO/TS 16949 requirements. Buyers acknowledge and agree that, if they use any non-designated products in automotive applications, TI will not be responsible for any failure to meet such requirements.

Following are URLs where you can obtain information on other Texas Instruments products and application solutions:

Products

Amplifiers	amplifier.ti.com
Data Converters	dataconverter.ti.com
DSP	dsp.ti.com
Clocks and Timers	www.ti.com/clocks
Interface	interface.ti.com
Logic	logic.ti.com
Power Mgmt	power.ti.com
Microcontrollers	microcontroller.ti.com
RFID	www.ti-rfid.com
RF/IF and ZigBee® Solutions	www.ti.com/lprf

Applications

Audio	www.ti.com/audio
Automotive	www.ti.com/automotive
Broadband	www.ti.com/broadband
Digital Control	www.ti.com/digitalcontrol
Medical	www.ti.com/medical
Military	www.ti.com/military
Optical Networking	www.ti.com/opticalnetwork
Security	www.ti.com/security
Telephony	www.ti.com/telephony
Video & Imaging	www.ti.com/video
Wireless	www.ti.com/wireless

Mailing Address: Texas Instruments, Post Office Box 655303, Dallas, Texas 75265
Copyright © 2008, Texas Instruments Incorporated