

TOSHIBA INFRARED LED GaAs INFRARED EMITTER

# TLN103A

INFRARED LED FOR PHOTODIODES

Unit : mm

OPTO-ELECTRONIC SWITCHES

SELECTORS

TAPE AND CARD READERS

EQUIPMENT USING INFRARED TRANSMISSION

- Wide half-angle value :  $\theta_{\frac{1}{2}} = \pm 80^\circ$  (typ.)
- Excellent radiant-intensity linearity. Modulation by pulse operation and high frequency is possible.
- Same external shape as TPS603A phototransistors
- Maximum distance when used as photosensor :
 

with DC drive $\approx 5$ mm	}	When TPS603A $I_L \approx 100 \mu A$
with pulse drive $\approx 30$ mm		

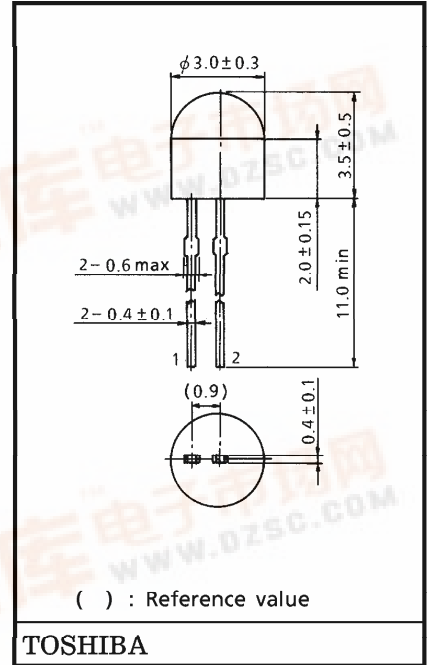

Weight : 0.08 g (typ.)

MAXIMUM RATINGS (Ta = 25°C)

CHARACTERISTIC	SYMBOL	RATING	UNIT
Forward Current	$I_F$	60	mA
Pulse Forward Current (Note)	$I_{FP}$	1	A
Reverse Voltage	$V_R$	5	V
Forward Current Derating (Ta > 25°C)	$\Delta I_F / ^\circ C$	-0.8	mA / °C
Operating Temperature Range	$T_{opr}$	-20~75	°C
Storage Temperature Range	$T_{stg}$	-30~100	°C

PIN CONNECTION



1. Anode
2. Cathode

(Note) : Pulse width  $\leq 100 \mu s$ , repetitive frequency = 100 Hz

OPTICAL AND ELECTRICAL CHARACTERISTICS (Ta = 25°C)

CHARACTERISTIC	SYMBOL	TEST CONDITION	Min	Typ.	Max	UNIT
Forward Voltage	$V_F$	$I_F = 10$ mA	1.00	1.15	1.30	V
Reverse Current	$I_R$	$V_R = 5$ V	—	—	10	$\mu A$
Radiant Intensity	$I_E$	$I_F = 20$ mA	0.5	1.0	—	mW / sr
Radiant Power	$P_o$	$I_F = 20$ mA	—	2.5	—	mW
Half Value Angle	$\theta_{\frac{1}{2}}$	$I_F = 20$ mA	—	$\pm 80$	—	°
Capacitance	$C_T$	$V_R = 0, f = 1$ MHz	—	30	—	pF
Peak Emission Wavelength	$\lambda_P$	$I_F = 20$ mA	—	940	—	nm
Spectral Line Half Width	$\Delta \lambda$	$I_F = 20$ mA	—	50	—	nm

**PRECAUTIONS**

Please be careful of the followings.

1. Soldering temperature : 260°C max  
Soldering time : 3 s max  
(Soldering must be performed 2 m from the bottom of the package.)
2. When forming the leads, bend each lead under the 2 mm from the body of the device.  
Soldering must be performed after the leads have been formed.
3. Radiation intensity falls over time due to the current which flows in the infrared LED.  
When designing a circuit, take into account this change in radiant power over time.  
The ratio of fluctuation in radiation intensity to fluctuation in optical output is 1 : 1.

$$\frac{I_E(t)}{I_E(0)} = \frac{P_O(t)}{P_O(0)}$$

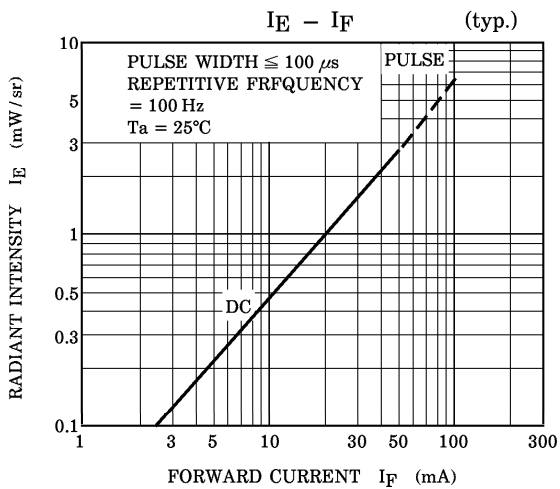
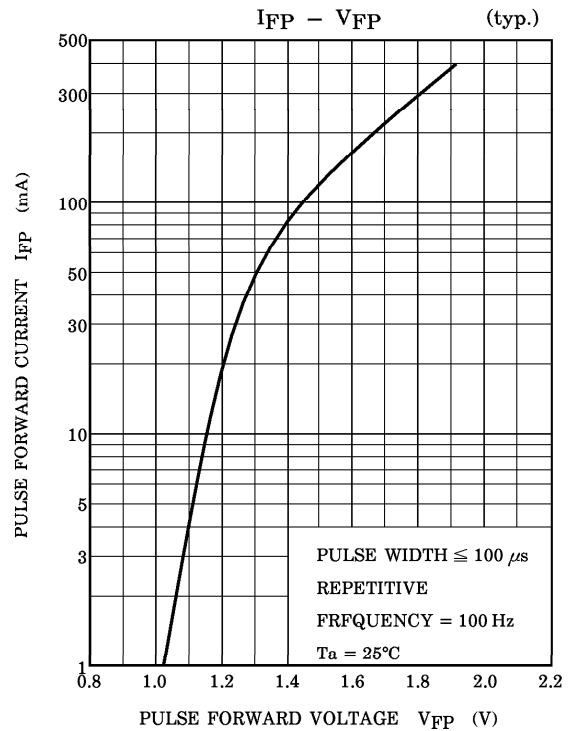
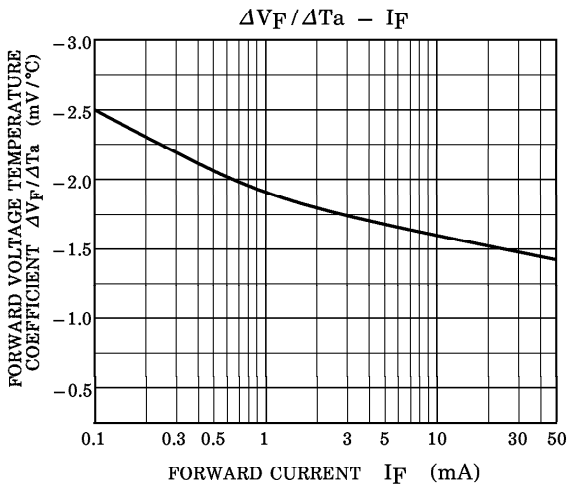
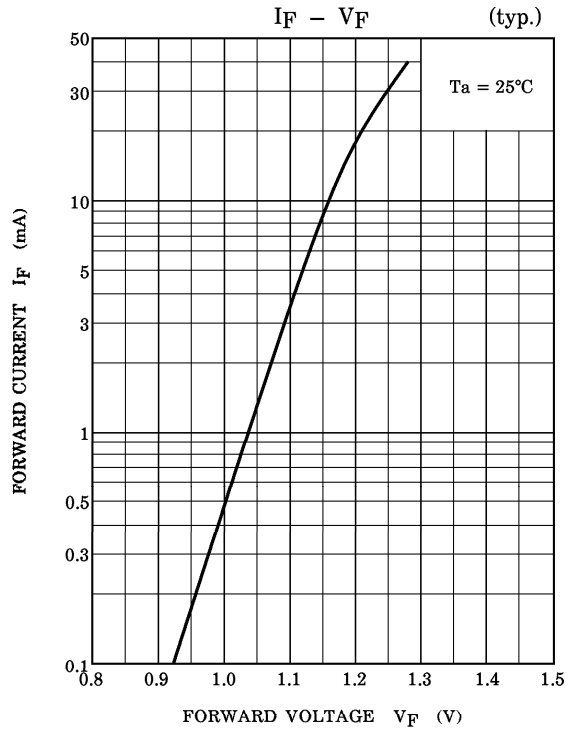
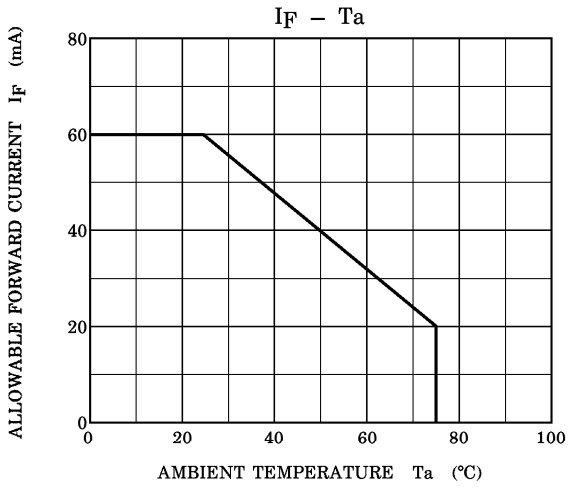

**WAVELENGTH CHARACTERISTIC**  
(typ.)

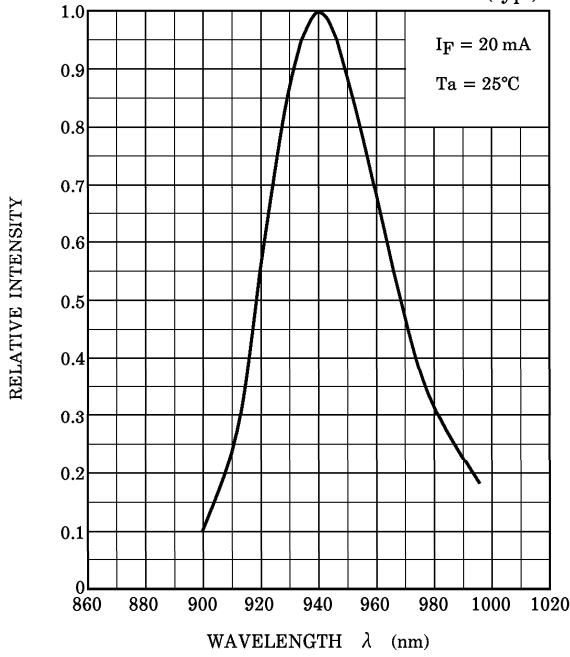

**RELATIVE  $I_E - T_a$**  (typ.)

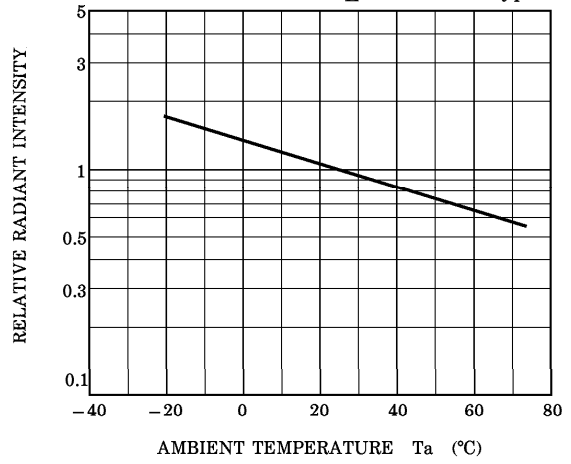

**RADIATION PATTERN** (typ.)  
( $T_a = 25^\circ\text{C}$ )

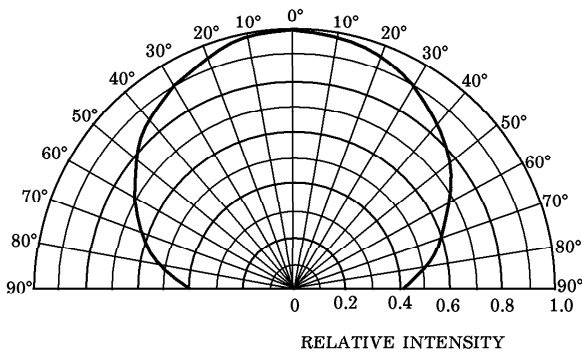

**$I_{FP} - P_W$**

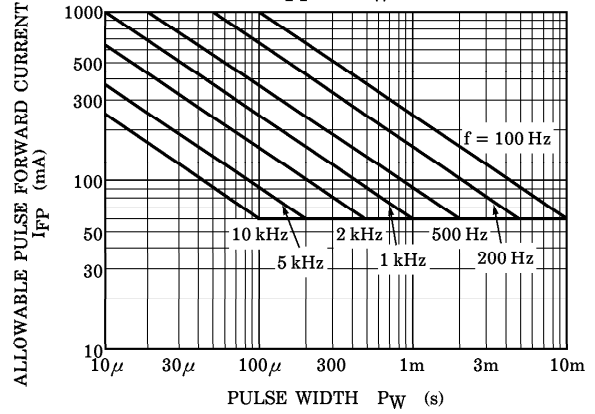

**RESTRICTIONS ON PRODUCT USE**

000707EAC

- TOSHIBA is continually working to improve the quality and reliability of its products. Nevertheless, semiconductor devices in general can malfunction or fail due to their inherent electrical sensitivity and vulnerability to physical stress. It is the responsibility of the buyer, when utilizing TOSHIBA products, to comply with the standards of safety in making a safe design for the entire system, and to avoid situations in which a malfunction or failure of such TOSHIBA products could cause loss of human life, bodily injury or damage to property. In developing your designs, please ensure that TOSHIBA products are used within specified operating ranges as set forth in the most recent TOSHIBA products specifications. Also, please keep in mind the precautions and conditions set forth in the "Handling Guide for Semiconductor Devices," or "TOSHIBA Semiconductor Reliability Handbook" etc..
- The TOSHIBA products listed in this document are intended for usage in general electronics applications (computer, personal equipment, office equipment, measuring equipment, industrial robotics, domestic appliances, etc.). These TOSHIBA products are neither intended nor warranted for usage in equipment that requires extraordinarily high quality and/or reliability or a malfunction or failure of which may cause loss of human life or bodily injury ("Unintended Usage"). Unintended Usage include atomic energy control instruments, airplane or spaceship instruments, transportation instruments, traffic signal instruments, combustion control instruments, medical instruments, all types of safety devices, etc.. Unintended Usage of TOSHIBA products listed in this document shall be made at the customer's own risk.
- Gallium arsenide (GaAs) is a substance used in the products described in this document. GaAs dust and fumes are toxic. Do not break, cut or pulverize the product, or use chemicals to dissolve them. When disposing of the products, follow the appropriate regulations. Do not dispose of the products with other industrial waste or with domestic garbage.
- The information contained herein is presented only as a guide for the applications of our products. No responsibility is assumed by TOSHIBA CORPORATION for any infringements of intellectual property or other rights of the third parties which may result from its use. No license is granted by implication or otherwise under any intellectual property or other rights of TOSHIBA CORPORATION or others.
- The information contained herein is subject to change without notice.