

TOSHIBA

Toshiba TLxH157 Series LEDs

Features

5mm Package
 InGaAIP Technology
 All Plastic Mold Type
 Water Clear Lens
 Fast Response Time, Capable of Pulse Operation
 High Power Luminous Intensity

Applications

Outdoor Message Signboard
 Safety equipment
 Automotive

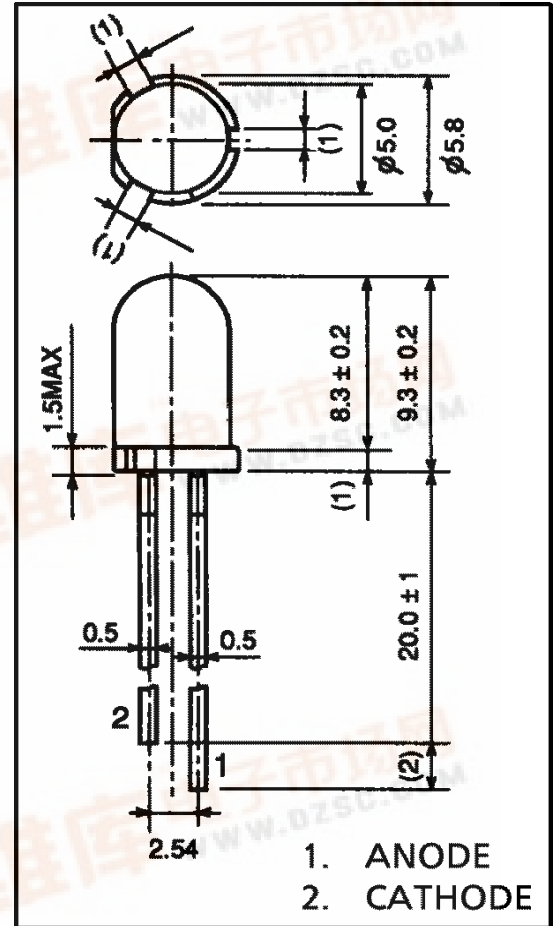

Series Line-Up

Part Number	Color	Material
TLOH157P	Ultra Bright Orange	InGaAIP
TLRH157P	Ultra Bright Red	InGaAIP
TLRMH157P	Ultra Red	InGaAIP
TLSH157P	Ultra Bright High Efficiency Red	InGaAIP
TLYH157P	Ultra Bright Yellow	InGaAIP

Maximum Ratings (Ta=25°C)

Part Number	Forward Current I _F	Reverse Voltage V _R	Power Dissipation P _D	Operating Temperature T _{opr}	Storage Temperature T _{stg}
TLOH157P	50	4	125.00	-30 ~ 85	-40 ~ 120
TLRH157P	50	4	125.00	-30 ~ 85	-40 ~ 120
TLRMH157P	50	4	125.00	-40 ~ 100	-40 ~ 120
TLSH157P	50	4	125.00	-30 ~ 85	-40 ~ 120
TLYH157P	50	4	125.00	-30 ~ 85	-40 ~ 120
Unit	mA	V	mW	°C	°C

Electrical and Optical Characteristics (Ta=25°C)

Part Number	PWL nm λP	Material	View Angle 2θ _{1/2}	Luminous Intensity I _v				Forward Voltage V _F				Rev Current I _R	
				min.	typ.	max.	IF@	min.	typ.	max.	IF@	max.	VR@
TLOH157P	612	InGaAlP	22°	850.00	2800.00	–	20mA	–	2.10	2.50	20mA	50	4V
TLRH157P	644	InGaAlP	22°	476.00	1700.00	–	20mA	–	1.90	2.50	20mA	50	4V
TLRMH157P	636	InGaAlP	22°	850.00	2240.00	–	20mA	–	2.05	2.50	20mA	50	4V
TLSH157P	623	InGaAlP	22°	850.00	2700.00	–	20mA	–	2.10	2.50	20mA	50	4V
TLYH157P	590	InGaAlP	22°	850.00	2500.00	–	20mA	–	2.10	2.50	20mA	50	4V
–	nm	–	deg	mcd				–	V		–	μA	–

Precautions

- Soldering temperature: 260°C max, soldering time: 3 s max (soldering portion of lead: up to 2 mm from the body of the device).
- If the lead is formed, the lead should be formed up to 5 mm from the body of the device without forming stress to the resin. Soldering should be performed after lead forming.
- This visible LED lamp also emits some IR light. If a photodetector is located near the LED lamp, please ensure that it will not be affected by this IR light.

NOTICE:

- TOSHIBA is continually working to improve the quality and reliability of its products. Nevertheless, semiconductor devices in general can malfunction or fail due to their inherent electrical sensitivity and vulnerability to physical stress. It is the responsibility of the buyer, when utilizing TOSHIBA products, to comply with the standards of safety in making a safe design for the entire system, and to avoid situations in which a malfunction or failure of such TOSHIBA products could cause loss of human life, bodily injury or damage to property.
- In developing your designs, please ensure that TOSHIBA products are used within specified operating ranges as set forth in the most recent TOSHIBA products specifications. Also, please keep in mind the precautions and conditions set forth in the "Handling Guide for Semiconductor Devices," or "TOSHIBA Semiconductor Reliability Handbook" etc..
- The TOSHIBA products listed in this document are intended for usage in general electronics applications (computer, personal equipment, office equipment, measuring equipment, industrial robotics, domestic appliances, etc.). These TOSHIBA products are neither intended nor warranted for usage in equipment that requires extraordinarily high quality and/or reliability or a malfunction or failure of which may cause loss of human life or bodily injury ("Unintended Usage"). Unintended Usage include atomic energy control instruments, airplane or spaceship instruments, transportation instruments, traffic signal instruments, combustion control instruments, medical instruments, all types of safety devices, etc.. Unintended Usage of TOSHIBA products listed in this document shall be made at the customer's own risk.
- Gallium arsenide (GaAs) is a substance used in the products described in this document. GaAs dust and fumes are toxic. Do not break, cut or pulverize the product, or use chemicals to dissolve them. When disposing of the products, follow the appropriate regulations. Do not dispose of the products with other industrial waste or with domestic garbage.
- The information contained herein is presented only as a guide for the applications of our products. No responsibility is assumed by TOSHIBA CORPORATION for any infringements of intellectual property or other rights of the third parties which may result from its use. No license is granted by implication or otherwise under any intellectual property or other rights of TOSHIBA CORPORATION or others.
- The information contained herein is subject to change without notice.

TLOH157P Graphs

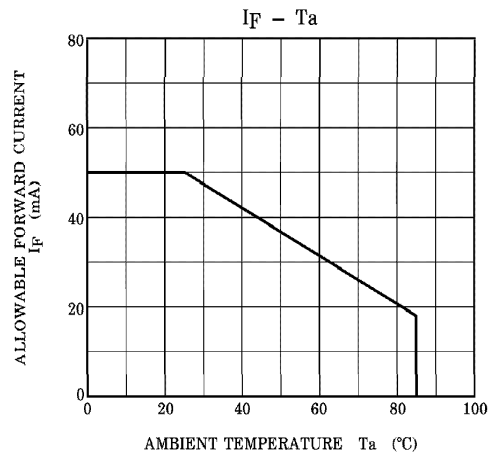
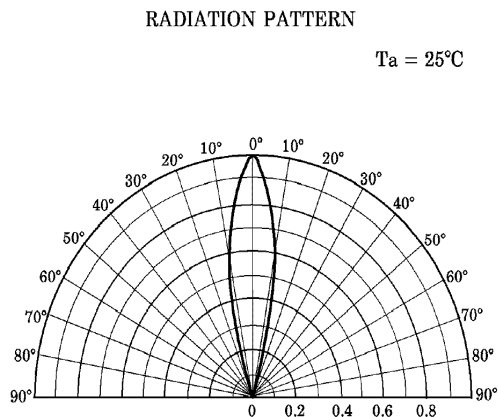
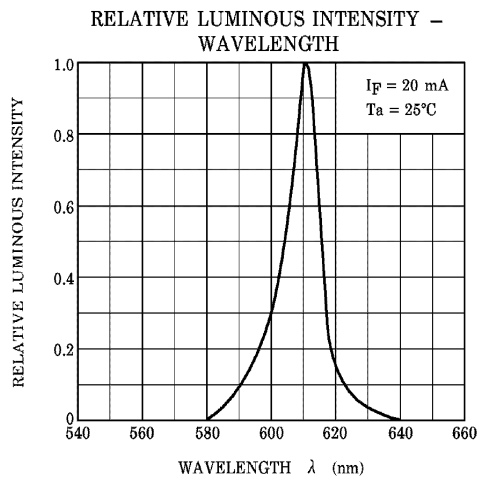
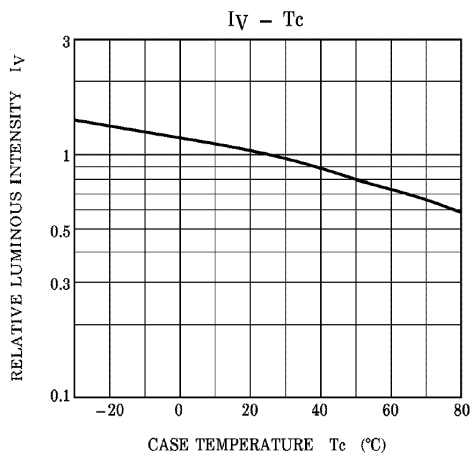
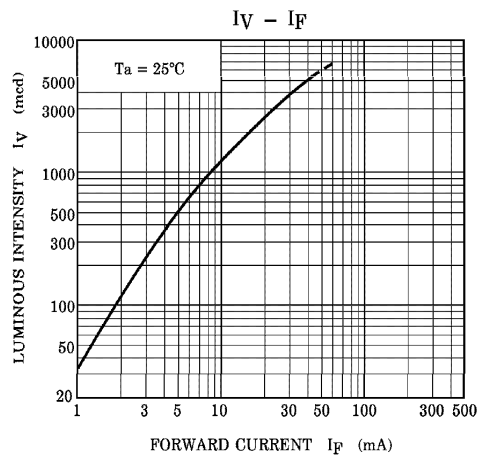
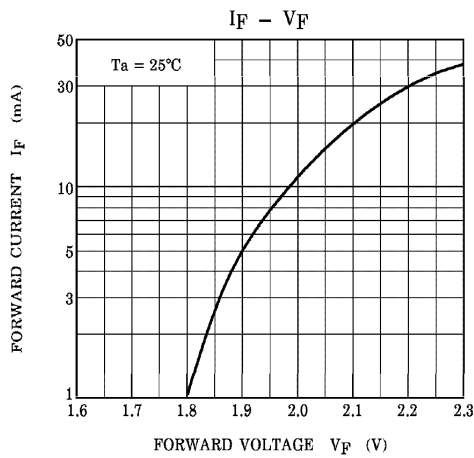

TLRH157P Graphs

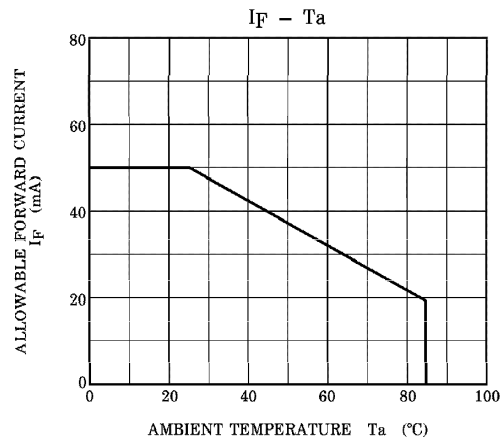
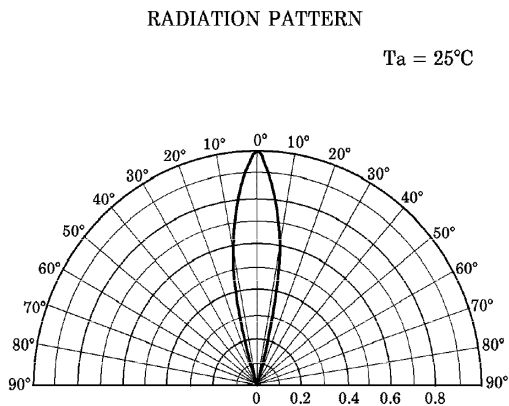
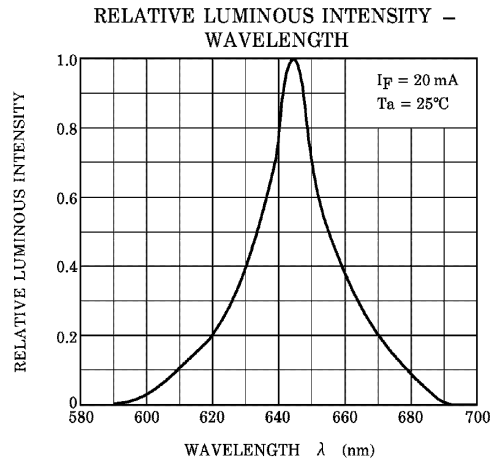
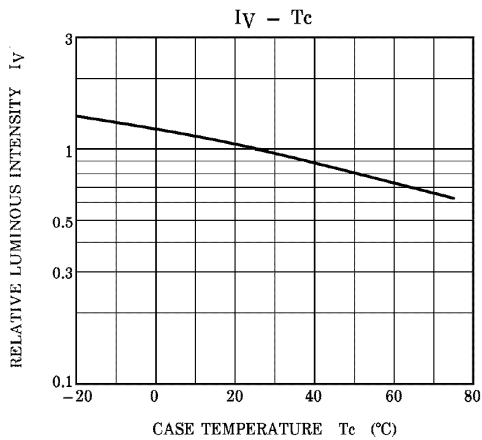
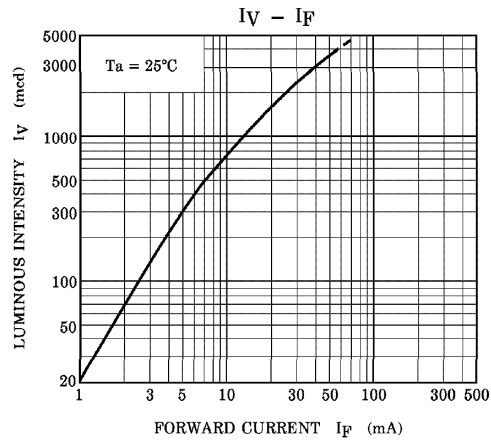
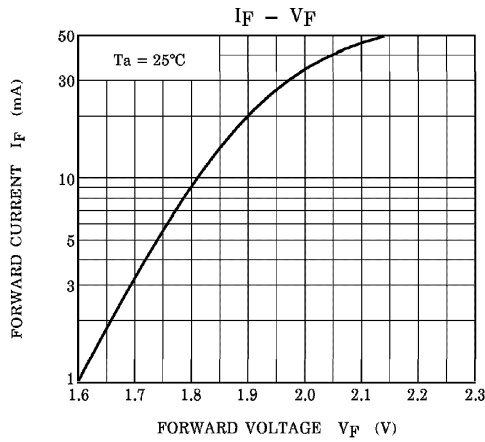

TLRMH157P Graphs

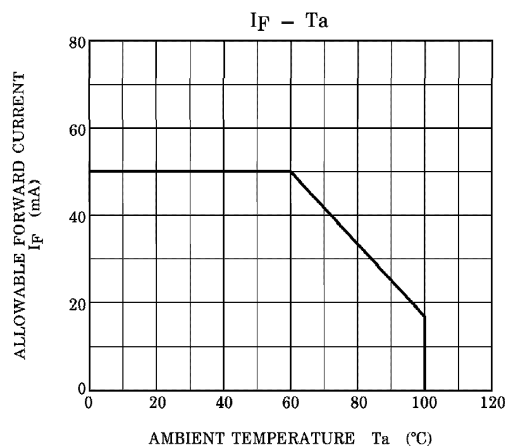
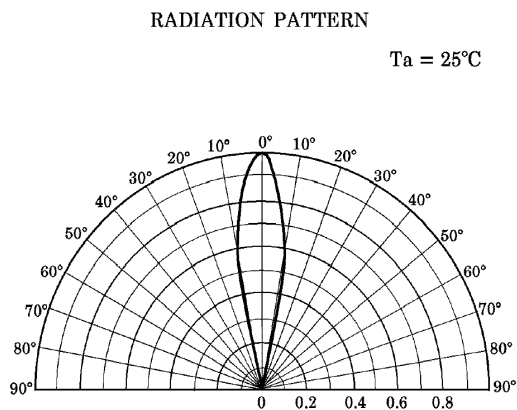
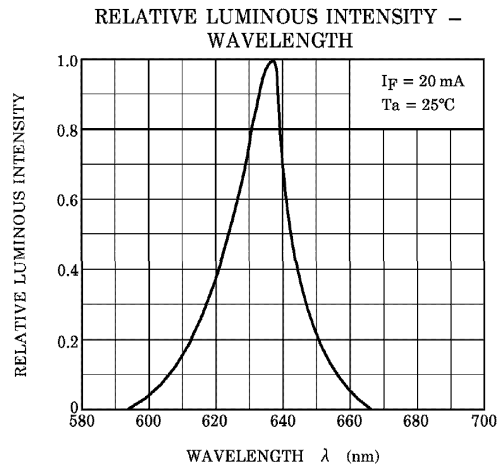
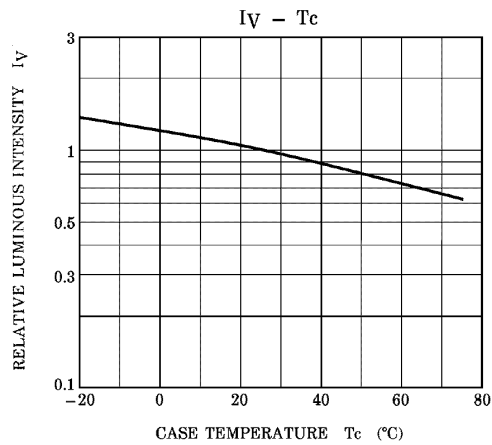
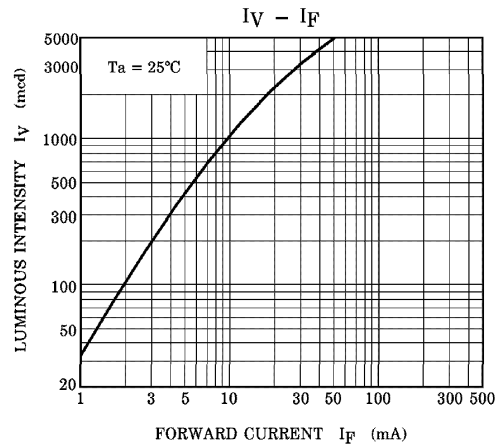
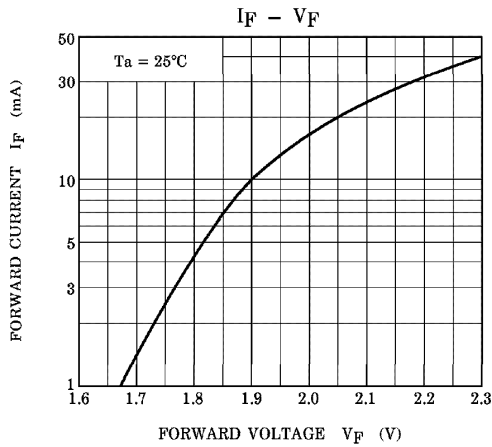

TLSH157P Graphs

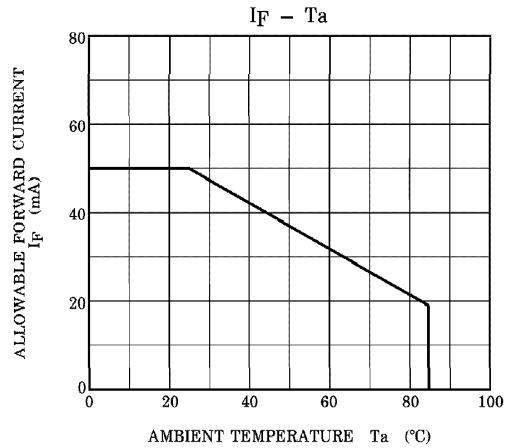
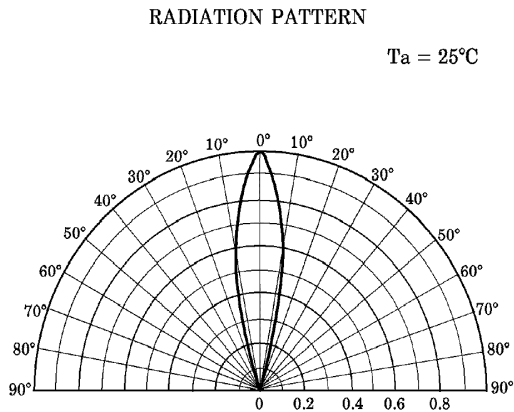
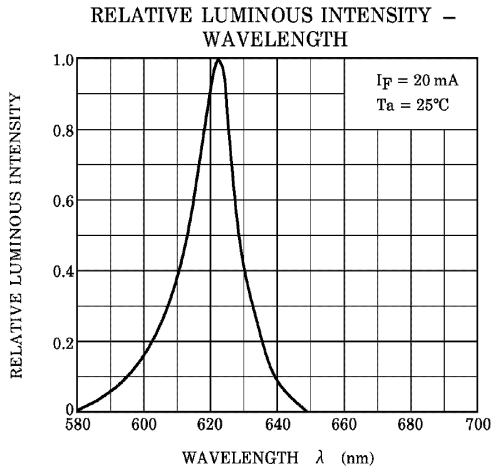
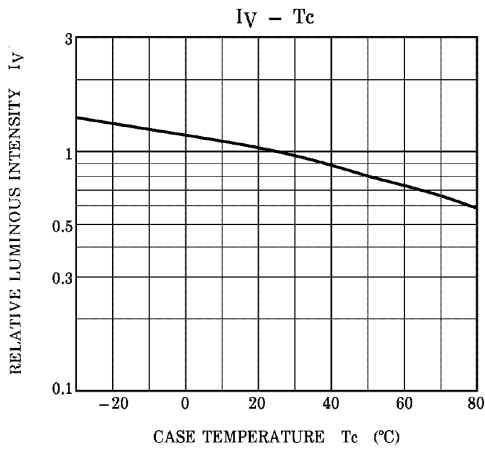
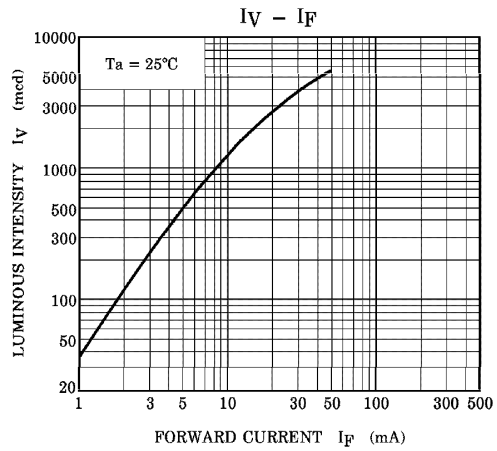
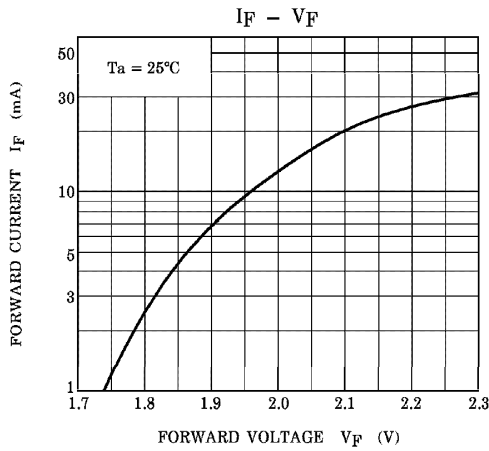

TLYH157P Graphs

