

- Output Swing Includes Both Supply Rails
- Low Noise . . . 12 nV/√Hz Typ at f = 1 kHz
- Low Input Bias Current . . . 1 pA Typ
- Fully Specified for Both Single-Supply and Split-Supply Operation
- Low Power . . . 500 μA Max
- Common-Mode Input Voltage Range Includes Negative Rail
- Low Input Offset Voltage  
950 μV Max at T<sub>A</sub> = 25°C (TLV226xA)
- Wide Supply Voltage Range  
2.7 V to 8 V
- Macromodel Included
- Available in Q-Temp Automotive  
HighRel Automotive Applications  
Configuration Control / Print Support  
Qualification to Automotive Standards

**description**

The TLV2262 and TLV2264 are dual and quad low voltage operational amplifiers from Texas Instruments. Both devices exhibit rail-to-rail output performance for increased dynamic range in single or split supply applications. The TLV226x family offers a compromise between the micro-power TLV225x and the ac performance of the TLC227x. It has low supply current for battery-powered applications, while still having adequate ac performance for applications that demand it. This family is fully characterized at 3 V and 5 V and is optimized for low-voltage applications. The noise performance has been dramatically improved over previous generations of CMOS amplifiers. Figure 1 depicts the low level of noise voltage for this CMOS amplifier, which has only 200 μA (typ) of supply current per amplifier.

The TLV226x, exhibiting high input impedance and low noise, are excellent for small-signal conditioning for high-impedance sources, such as piezoelectric transducers. Because of the micro-power dissipation levels combined with 3-V operation, these devices work well in hand-held monitoring and remote-sensing applications. In addition, the rail-to-rail output feature with single or split supplies makes this family a great choice when interfacing with analog-to-digital converters (ADCs). For precision applications, the TLV226xA family is available and has a maximum input offset voltage of 950 μV.

The TLV2262/4 also makes great upgrades to the TLV2332/4 in standard designs. They offer increased output dynamic range, lower noise voltage and lower input offset voltage. This enhanced feature set allows them to be used in a wider range of applications. For applications that require higher output drive and wider input voltage range, see the TLV2432 and TLV2442 devices. If your design requires single amplifiers, please see the TLV2211/21/31 family. These devices are single rail-to-rail operational amplifiers in the SOT-23 package. Their small size and low power consumption, make them ideal for high density, battery-powered equipment.

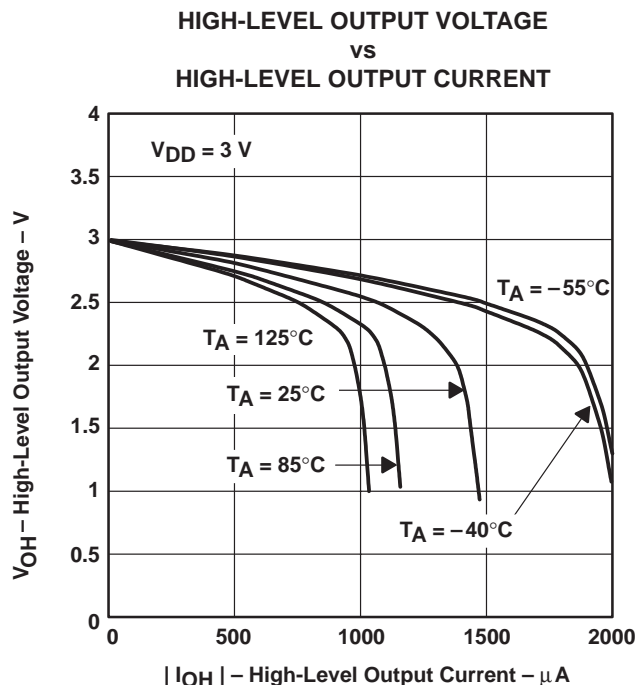

Figure 1



Please be aware that an important notice concerning availability, standard warranty, and use in critical applications of Texas Instruments semiconductor products and disclaimers thereto appears at the end of this data sheet.

Advanced LinCMOS is a trademark of Texas Instruments Incorporated.

PRODUCTION DATA information is current as of publication date. Products conform to specifications per the terms of Texas Instruments standard warranty. Production processing does not necessarily include testing of all parameters.



POST OFFICE BOX 655303 • DALLAS, TEXAS 75265

Copyright © 1999, Texas Instruments Incorporated  
On products compliant to MIL-PRF-38535, all parameters are tested unless otherwise noted. On all other products, production processing does not necessarily include testing of all parameters.

**TLV226x, TLV226xA**  
**Advanced LinCMOS™ RAIL-TO-RAIL**  
**OPERATIONAL AMPLIFIERS**

SLOS186A – FEBRUARY 1997 – REVISED JULY 1999

**TLV2262 AVAILABLE OPTIONS**

T <sub>A</sub>	V <sub>IO</sub> max AT 25°C	PACKAGED DEVICES					
		SMALL OUTLINE (D)	CHIP CARRIER (FK)	CERAMIC DIP (JG)	PLASTIC DIP (P)	TSSOP (PW)	CERAMIC FLATPACK (U)
0°C to 70°C	2.5 mV	TLV2262CD	—	—	TLV2262CP	TLV2262CPWLE	—
–40°C to 85°C	950 µV 2.5 mV	TLV2262AID TLV2262ID	— —	— —	TLV2262AIP TLV2262IP	TLV2262AIPWLE —	— —
–40°C to 125°C	950 µV 2.5 mV	TLV2262AQD TLV2262QD	— —	— —	— —	— —	— —
–55°C to 125°C	950 µV 2.5 mV	— —	TLV2262AMFK TLV2262MFK	TLV2262AMJG TLV2262MJG	— —	— —	TLV2262AMU TLV2262MU

† The D packages are available taped and reeled. Add R suffix to device type (e.g., TLV2262CDR).

‡ The PW package is available only left-end taped and reeled.

§ Chips are tested at 25°C.

**TLV2264 AVAILABLE OPTIONS**

T <sub>A</sub>	V <sub>IO</sub> max AT 25°C	PACKAGED DEVICES					
		SMALL OUTLINE (D)	CHIP CARRIER (FK)	CERAMIC DIP (J)	PLASTIC DIP (N)	TSSOP (PW)	CERAMIC FLATPACK (W)
–40°C to 85°C	950 µV 2.5 mV	TLV2264AID TLV2264ID	— —	— —	TLV2264AIN TLV2264IN	TLV2264AIPWLE —	— —
–40°C to 125°C	950 µV 2.5 mV	TLV2264AQD TLV2264QD	— —	— —	— —	— —	— —
–55°C to 125°C	950 µV 2.5 mV	— —	TLV2264AMFK TLV2264MFK	TLV2264AMJ TLV2264MJ	— —	— —	TLV2264AMW TLV2264MW

† The D packages are available taped and reeled. Add R suffix to device type (e.g., TLV2262IDR).

‡ The PW package is available only left-end taped and reeled.

§ Chips are tested at 25°C.



# TLV226x, TLV226xA Advanced LinCMOS™ RAIL-TO-RAIL OPERATIONAL AMPLIFIERS

SLOS186A – FEBRUARY 1997 – REVISED JULY 1999

**TLV2262C, TLV2262AC  
TLV2262I, TLV2262AI  
TLV2262Q, TLV2262AQ  
D, P, OR PW PACKAGE  
(TOP VIEW)**

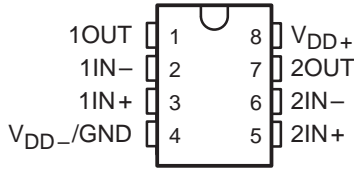

**TLV2262M, TLV2262AM  
JG PACKAGE  
(TOP VIEW)**

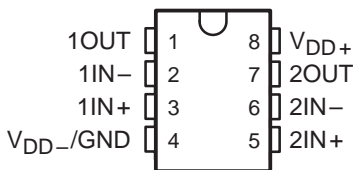

**TLV2662M, TLV2262AM  
U PACKAGE  
(TOP VIEW)**

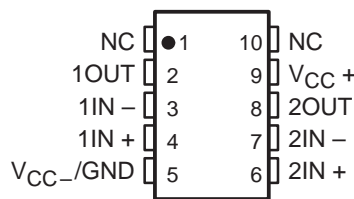

**TLV2262M, TLV2262AM  
FK PACKAGE  
(TOP VIEW)**

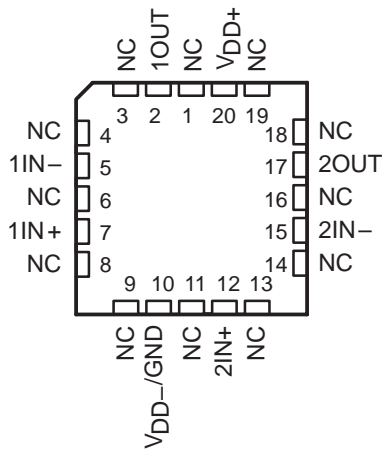

**TLV2264I, TLV2264AI  
TLV2264Q, TLV2264AQ  
D, N, OR PW PACKAGE  
(TOP VIEW)**

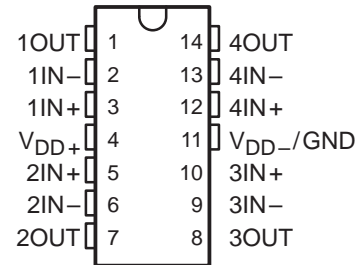

**TLV2264M, TLV2264AM  
J OR W PACKAGE  
(TOP VIEW)**

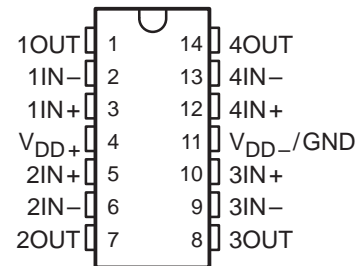

**TLV2264M, TLV2264AM  
FK PACKAGE  
(TOP VIEW)**

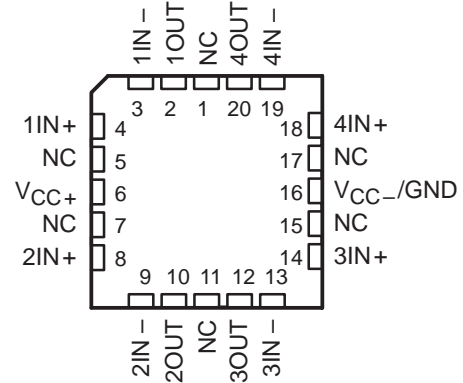

# TLV226x, TLV226xA

## Advanced LinCMOS™ RAIL-TO-RAIL

### OPERATIONAL AMPLIFIERS

SLOS186A – FEBRUARY 1997 – REVISED JULY 1999

equivalent schematic (each amplifier)

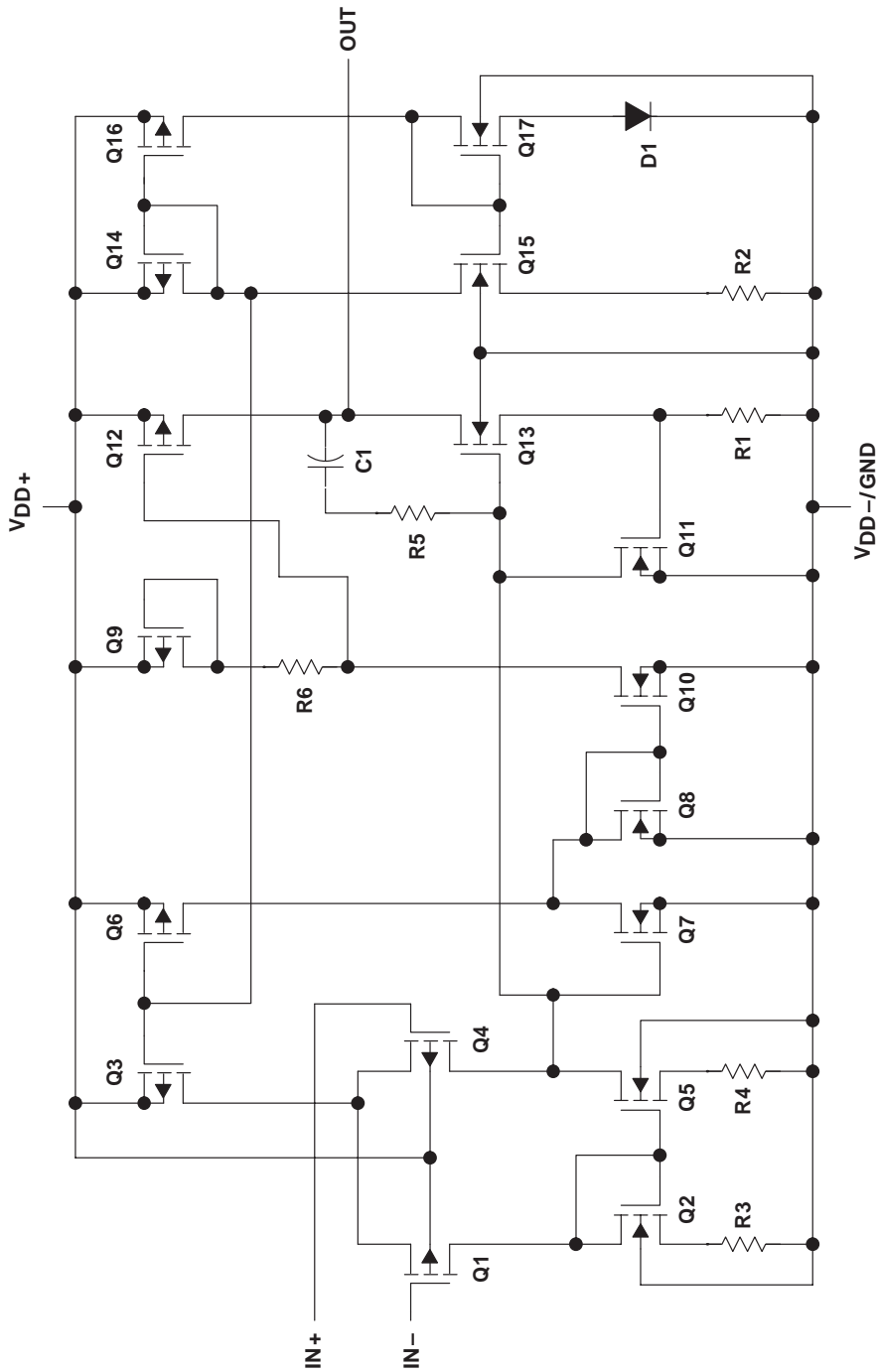

ACTUAL DEVICE COMPONENT COUNT†		
COMPONENT	TLV2252	TLV2254
Transistors	38	76
Resistors	28	54
Diodes	9	18
Capacitors	3	6

† Includes both amplifiers and all ESD, bias, and trim circuitry

**absolute maximum ratings over operating free-air temperature range (unless otherwise noted)†**

Supply voltage, $V_{DD}$ (see Note 1)	8 V
Differential input voltage, $V_{ID}$ (see Note 2)	$\pm V_{DD}$
Input voltage range, $V_I$ (any input, see Note 1)	$V_{DD-} - 0.3$ V to $V_{DD+}$
Input current, $I_I$ (each input)	$\pm 5$ mA
Output current, $I_O$	$\pm 50$ mA
Total current into $V_{DD+}$	$\pm 50$ mA
Total current out of $V_{DD-}$	$\pm 50$ mA
Duration of short-circuit current (at or below) 25°C (see Note 3)	unlimited
Continuous total power dissipation	See Dissipation Rating Table
Operating free-air temperature range, $T_A$ :	
I suffix	–40°C to 85°C
Q suffix	–40°C to 125°C
M suffix	–55°C to 125°C
Storage temperature range, $T_{stg}$	–65°C to 150°C
Lead temperature 1,6 mm (1/16 inch) from case for 10 seconds: D, N, P, and PW packages	260°C
FK, J, JG, U, AND W packages	300°C

† Stresses beyond those listed under “absolute maximum ratings” may cause permanent damage to the device. These are stress ratings only, and functional operation of the device at these or any other conditions beyond those indicated under “recommended operating conditions” is not implied. Exposure to absolute-maximum-rated conditions for extended periods may affect device reliability.

- NOTES:
1. All voltage values, except differential voltages, are with respect to  $V_{DD-}$ .
  2. Differential voltages are at the noninverting input with respect to the inverting input. Excessive current flows when input is brought below  $V_{DD-} - 0.3$  V.
  3. The output may be shorted to either supply. Temperature and/or supply voltages must be limited to ensure that the maximum dissipation rating is not exceeded.

**DISSIPATION RATING TABLE**

PACKAGE	$T_A \leq 25^\circ\text{C}$ POWER RATING	DERATING FACTOR ABOVE $T_A = 25^\circ\text{C}$	$T_A = 85^\circ\text{C}$ POWER RATING	$T_A = 125^\circ\text{C}$ POWER RATING
D–8	725 mW	5.8 mW/°C	377 mW	145 mW
D–14	950 mW	7.6 mW/°C	494 mW	190 mW
FK	1375 mW	11.0 mW/°C	715 mW	275 mW
J	1375 mW	11.0 mW/°C	715 mW	275 mW
JG	1050 mW	8.4 mW/°C	—	210 mW
N	1150 mW	9.2 mW/°C	598 mW	—
P	1000 mW	8.0 mW/°C	520 mW	200 mW
PW–8	525 mW	4.2 mW/°C	273 mW	105 mW
PW–14	700 mW	5.6 mW/°C	364 mW	—
U	700 mW	5.5 mW/°C	—	150 mW
W	700 mW	5.5 mW/°C	370 mW	150 mW

**recommended operating conditions**

	I SUFFIX		Q SUFFIX		M SUFFIX		UNIT
	MIN	MAX	MIN	MAX	MIN	MAX	
Supply voltage, $V_{DD\pm}$ (see Note 1)	2.7	8	2.7	8	2.7	8	V
Input voltage range, $V_I$	$V_{DD-}$	$V_{DD+} - 1.3$	$V_{DD-}$	$V_{DD+} - 1.3$	$V_{DD-}$	$V_{DD+} - 1.3$	V
Common-mode input voltage, $V_{IC}$	$V_{DD-}$	$V_{DD+} - 1.3$	$V_{DD-}$	$V_{DD+} - 1.3$	$V_{DD-}$	$V_{DD+} - 1.3$	V
Operating free-air temperature, $T_A$	–40	85	–40	125	–55	125	°C

NOTE 1: All voltage values, except differential voltages, are with respect to  $V_{DD-}$ .

# TLV226x, TLV226xA Advanced LinCMOS™ RAIL-TO-RAIL OPERATIONAL AMPLIFIERS

SLOS186A – FEBRUARY 1997 – REVISED JULY 1999

**TLV2262I electrical characteristics at specified free-air temperature,  $V_{DD} = 3\text{ V}$  (unless otherwise noted)**

PARAMETER	TEST CONDITIONS	$T_A$ †	TLV2262I			TLV2262AI			UNIT
			MIN	TYP	MAX	MIN	TYP	MAX	
$V_{IO}$ Input offset voltage	$V_{DD\pm} = \pm 1.5\text{ V}$ , $V_{IC} = 0$ , $V_O = 0$ , $R_S = 50\ \Omega$	25°C		300	2500		300	950	$\mu\text{V}$
		Full range			3000			1500	
$\alpha_{VIO}$ Temperature coefficient of input offset voltage		25°C to 85°C		2			2		$\mu\text{V}/^\circ\text{C}$
Input offset voltage long-term drift (see Note 4)		25°C		0.003			0.003		$\mu\text{V}/\text{mo}$
$I_{IO}$ Input offset current		25°C		0.5			0.5		$\text{pA}$
		Full range			150			150	
$I_{IB}$ Input bias current	25°C		1			1		$\text{pA}$	
	Full range			150			150		
$V_{ICR}$ Common-mode input voltage range	$R_S = 50\ \Omega$ , $ V_{IO}  \leq 5\text{ mV}$	25°C	0 to 2	-0.3 to 2.2		0 to 2	-0.3 to 2.2	$\text{V}$	
		Full range	0 to 1.7			0 to 1.7			
$V_{OH}$ High-level output voltage	$I_{OH} = -20\ \mu\text{A}$	25°C		2.99			2.99	$\text{V}$	
	$I_{OH} = -100\ \mu\text{A}$	25°C		2.85			2.85		
	$I_{OH} = -400\ \mu\text{A}$	Full range		2.825			2.825		
		25°C		2.7			2.7		
$V_{OL}$ Low-level output voltage	$V_{IC} = 1.5\text{ V}$ , $I_{OL} = 50\ \mu\text{A}$	25°C		10			10	$\text{mV}$	
	$V_{IC} = 1.5\text{ V}$ , $I_{OL} = 500\ \mu\text{A}$	25°C		100			100		
	$V_{IC} = 1.5\text{ V}$ , $I_{OL} = 1\text{ mA}$	Full range			150				150
		25°C		200			200		
$A_{VD}$ Large-signal differential voltage amplification	$V_{IC} = 1.5\text{ V}$ , $V_O = 1\text{ V to }2\text{ V}$	$R_L = 50\ \text{k}\Omega$ ‡	25°C	60	100		60	100	$\text{V}/\text{mV}$
			Full range		30			30	
		$R_L = 1\ \text{M}\Omega$ ‡	25°C		100			100	
$r_{i(d)}$ Differential input resistance		25°C		$10^{12}$			$10^{12}$	$\Omega$	
$r_{i(c)}$ Common-mode input resistance		25°C		$10^{12}$			$10^{12}$	$\Omega$	
$C_{i(c)}$ Common-mode input capacitance	$f = 10\ \text{kHz}$ , P package	25°C		8			8	$\text{pF}$	
$z_o$ Closed-loop output impedance	$f = 100\ \text{kHz}$ , $A_V = 10$	25°C		270			270	$\Omega$	
CMRR Common-mode rejection ratio	$V_{IC} = 0\text{ to }1.7\text{ V}$ , $V_O = 1.5\text{ V}$ , $R_S = 50\ \Omega$	25°C	65	75		65	77	$\text{dB}$	
		Full range		60			60		
$k_{SVR}$ Supply voltage rejection ratio ( $\Delta V_{DD}/\Delta V_{IO}$ )	$V_{DD} = 2.7\text{ V to }8\text{ V}$ , $V_{IC} = V_{DD}/2$ , No load	25°C	80	95		80	100	$\text{dB}$	
		Full range		80			80		
$I_{DD}$ Supply current	$V_O = 1.5\text{ V}$ , No load	25°C		400	500		400	500	$\mu\text{A}$
		Full range			500			500	

† Full range is  $-40^\circ\text{C}$  to  $85^\circ\text{C}$ .

‡ Referenced to 1.5 V

NOTE 4: Typical values are based on the input offset voltage shift observed through 500 hours of operating life test at  $T_A = 150^\circ\text{C}$  extrapolated to  $T_A = 25^\circ\text{C}$  using the Arrhenius equation and assuming an activation energy of 0.96 eV.



**TLV2262I operating characteristics at specified free-air temperature,  $V_{DD} = 3\text{ V}$**

PARAMETER	TEST CONDITIONS	$T_A$ †	TLV2262I			TLV2262AI			UNIT
			MIN	TYP	MAX	MIN	TYP	MAX	
SR	Slew rate at unity gain $V_O = 1.1\text{ V to }1.9\text{ V}$ , $R_L = 50\text{ k}\Omega$ ‡, $C_L = 100\text{ pF}$ ‡	25°C	0.35	0.55		0.35	0.55		V/ $\mu\text{s}$
		Full range	0.3			0.3			
$V_n$	Equivalent input noise voltage	f = 10 Hz		43			43		nV/ $\sqrt{\text{Hz}}$
		f = 1 kHz		12			12		
$V_{N(PP)}$	Peak-to-peak equivalent input noise voltage	f = 0.1 Hz to 1 Hz		0.6			0.6		$\mu\text{V}$
		f = 0.1 Hz to 10 Hz		1			1		
$I_n$	Equivalent input noise current	25°C		0.6			0.6	fA/ $\sqrt{\text{Hz}}$	
THD + N	Total harmonic distortion plus noise $V_O = 0.5\text{ V to }2.5\text{ V}$ , f = 20 kHz, $R_L = 50\text{ k}\Omega$ ‡	$A_V = 1$		0.03%			0.03%		
		$A_V = 10$		0.05%			0.05%		
	Gain-bandwidth product f = 1 kHz, $C_L = 100\text{ pF}$ ‡	$R_L = 50\text{ k}\Omega$ ‡, 25°C		0.67			0.67	MHz	
$B_{OM}$	Maximum output-swing bandwidth $V_{O(PP)} = 1\text{ V}$ , $R_L = 50\text{ k}\Omega$ ‡,	$A_V = 1$ , $C_L = 100\text{ pF}$ ‡	25°C		395			395	kHz
$t_s$	Settling time $A_V = -1$ , Step = 1 V to 2 V, $R_L = 50\text{ k}\Omega$ ‡, $C_L = 100\text{ pF}$ ‡	To 0.1%	25°C		5.6			5.6	$\mu\text{s}$
		To 0.01%			12.5			12.5	
$\phi_m$	Phase margin at unity gain	$R_L = 50\text{ k}\Omega$ ‡,	25°C		55°			55°	
	Gain margin	$C_L = 100\text{ pF}$ ‡		25°C		11			

† Full range is –40°C to 85°C.

‡ Referenced to 1.5 V

# TLV226x, TLV226xA Advanced LinCMOS™ RAIL-TO-RAIL OPERATIONAL AMPLIFIERS

SLOS186A – FEBRUARY 1997 – REVISED JULY 1999

**TLV2262I electrical characteristics at specified free-air temperature,  $V_{DD} = 5\text{ V}$  (unless otherwise noted)**

PARAMETER	TEST CONDITIONS	$T_A$ †	TLV2262I			TLV2262AI			UNIT
			MIN	TYP	MAX	MIN	TYP	MAX	
$V_{IO}$ Input offset voltage	$V_{DD\pm} = \pm 2.5\text{ V}$ , $V_{IC} = 0$ , $V_O = 0$ , $R_S = 50\ \Omega$	25°C	300	2500		300	950	$\mu\text{V}$	
		Full range			3000		1500		
$\alpha_{VIO}$ Temperature coefficient of input offset voltage		25°C to 85°C	2			2		$\mu\text{V}/^\circ\text{C}$	
Input offset voltage long-term drift (see Note 4)		25°C	0.003			0.003		$\mu\text{V}/\text{mo}$	
$I_{IO}$ Input offset current		25°C	0.5			0.5		$\text{pA}$	
		Full range			150		150		
$I_{IB}$ Input bias current	25°C	1			1		$\text{pA}$		
	Full range			150		150			
$V_{ICR}$ Common-mode input voltage range	$ V_{IO}  \leq 5\text{ mV}$ , $R_S = 50\ \Omega$	25°C	0 to 4	-0.3 to 4.2		0 to 4	-0.3 to 4.2	V	
		Full range	0 to 3.5			0 to 3.5			
$V_{OH}$ High-level output voltage	$I_{OH} = -20\ \mu\text{A}$	25°C	4.99			4.99	V		
		25°C	4.85	4.94		4.85		4.94	
		Full range	4.82			4.82			
		25°C	4.7	4.85		4.7		4.85	
$V_{OL}$ Low-level output voltage	$V_{IC} = 2.5\text{ V}$ , $I_{OL} = -400\ \mu\text{A}$	25°C	0.01			0.01	V		
		25°C	0.09	0.15		0.09		0.15	
		Full range			0.15			0.15	
		25°C	0.2	0.3		0.2		0.3	
$V_{OL}$ Low-level output voltage	$V_{IC} = 2.5\text{ V}$ , $I_{OL} = 1\text{ mA}$	25°C	0.01			0.01	V		
		25°C	0.09	0.15		0.09		0.15	
		Full range			0.15			0.15	
		25°C	0.2	0.3		0.2		0.3	
$A_{VD}$ Large-signal differential voltage amplification	$V_{IC} = 2.5\text{ V}$ , $V_O = 1\text{ V to }4\text{ V}$	$R_L = 50\text{ k}\Omega$ ‡	25°C	80	170		80	170	V/mV
			Full range	55			55		
		$R_L = 1\text{ M}\Omega$ ‡	25°C	550			550		
$r_{i(d)}$ Differential input resistance		25°C	10 <sup>12</sup>			10 <sup>12</sup>	$\Omega$		
$r_{i(c)}$ Common-mode input resistance		25°C	10 <sup>12</sup>			10 <sup>12</sup>	$\Omega$		
$c_{i(c)}$ Common-mode input capacitance	f = 10 kHz, P package	25°C	8			8	pF		
$z_o$ Closed-loop output impedance	f = 100 kHz, $A_V = 10$	25°C	240			240	$\Omega$		
CMRR Common-mode rejection ratio	$V_{IC} = 0\text{ to }2.7\text{ V}$ , $V_O = 2.5\text{ V}$ , $R_S = 50\ \Omega$	25°C	70	83		70	83	dB	
		Full range	70			70			
$k_{SVR}$ Supply voltage rejection ratio ( $\Delta V_{DD}/\Delta V_{IO}$ )	$V_{DD} = 4.4\text{ V to }8\text{ V}$ , $V_{IC} = V_{DD}/2$ , No load	25°C	80	95		80	95	dB	
		Full range	80			80			
$I_{DD}$ Supply current	$V_O = 2.5\text{ V}$ , No load	25°C	400	500		400	500	$\mu\text{A}$	
		Full range			500		500		

† Full range is -40°C to 85°C.

‡ Referenced to 2.5 V

NOTE 4: Typical values are based on the input offset voltage shift observed through 500 hours of operating life test at  $T_A = 150^\circ\text{C}$  extrapolated to  $T_A = 25^\circ\text{C}$  using the Arrhenius equation and assuming an activation energy of 0.96 eV.





**TLV2262I operating characteristics at specified free-air temperature,  $V_{DD} = 5\text{ V}$**

PARAMETER	TEST CONDITIONS	$T_A$ †	TLV2262I			TLV2262AI			UNIT
			MIN	TYP	MAX	MIN	TYP	MAX	
SR	Slew rate at unity gain $V_O = 1.5\text{ V to }3.5\text{ V}, R_L = 50\text{ k}\Omega\ddagger, C_L = 100\text{ pF}\ddagger$	25°C	0.35	0.55		0.35	0.55		V/ $\mu\text{s}$
		Full range	0.3			0.3			
$V_n$	Equivalent input noise voltage $f = 10\text{ Hz}$ $f = 1\text{ kHz}$	25°C		40			40		nV/ $\sqrt{\text{Hz}}$
		25°C		12			12		
$V_{N(PP)}$	Peak-to-peak equivalent input noise voltage $f = 0.1\text{ Hz to }1\text{ Hz}$ $f = 0.1\text{ Hz to }10\text{ Hz}$	25°C		0.7			0.7		$\mu\text{V}$
		25°C		1.3			1.3		
$I_n$	Equivalent input noise current	25°C		0.6			0.6		fA/ $\sqrt{\text{Hz}}$
THD + N	Total harmonic distortion plus noise $V_O = 0.5\text{ V to }2.5\text{ V}, f = 20\text{ kHz}, R_L = 50\text{ k}\Omega\ddagger$	$A_V = 1$	25°C		0.017%			0.017%	
		$A_V = 10$	25°C		0.03%			0.03%	
	Gain-bandwidth product $f = 50\text{ kHz}, C_L = 100\text{ pF}\ddagger, R_L = 50\text{ k}\Omega\ddagger$	25°C		0.71			0.71		MHz
BOM	Maximum output-swing bandwidth $V_{O(PP)} = 2\text{ V}, R_L = 50\text{ k}\Omega\ddagger, A_V = 1, C_L = 100\text{ pF}\ddagger$	25°C		185			185		kHz
$t_s$	Settling time $A_V = -1, \text{ Step} = 0.5\text{ V to }2.5\text{ V}, R_L = 50\text{ k}\Omega\ddagger, C_L = 100\text{ pF}\ddagger$	To 0.1%	25°C		6.4			6.4	$\mu\text{s}$
		To 0.01%	25°C		14.1			14.1	
$\phi_m$	Phase margin at unity gain $R_L = 50\text{ k}\Omega\ddagger, C_L = 100\text{ pF}\ddagger$	25°C		56°			56°		
	Gain margin	25°C		11			11		dB

† Full range is  $-40^\circ\text{C}$  to  $85^\circ\text{C}$ .

‡ Referenced to 2.5 V

# TLV226x, TLV226xA Advanced LinCMOS™ RAIL-TO-RAIL OPERATIONAL AMPLIFIERS

SLOS186A – FEBRUARY 1997 – REVISED JULY 1999

**TLV2264I electrical characteristics at specified free-air temperature,  $V_{DD} = 3\text{ V}$  (unless otherwise noted)**

PARAMETER	TEST CONDITIONS	$T_A$ †	TLV2264I			TLV2264AI			UNIT	
			MIN	TYP	MAX	MIN	TYP	MAX		
$V_{IO}$ Input offset voltage	$V_{DD\pm} = \pm 1.5\text{ V}$ , $V_{IC} = 0$ , $V_O = 0$ , $R_S = 50\ \Omega$	25°C	300	2500		300	950	$\mu\text{V}$		
		Full range		3000		1500				
$\alpha_{VIO}$ Temperature coefficient of input offset voltage		25°C to 85°C	2			2		$\mu\text{V}/^\circ\text{C}$		
Input offset voltage long-term drift (see Note 4)		25°C	0.003			0.003		$\mu\text{V}/\text{mo}$		
$I_{IO}$ Input offset current		25°C	0.5			0.5		$\text{pA}$		
		Full range		150		150				
$I_{IB}$ Input bias current	25°C	1			1		$\text{pA}$			
	Full range		150		150					
$V_{ICR}$ Common-mode input voltage range	$R_S = 50\ \Omega$ , $ V_{IO}  \leq 5\text{ mV}$	25°C	0 to 2	-0.3 to 2.2		0 to 2	-0.3 to 2.2	$\text{V}$		
		Full range	0 to 1.7			0 to 1.7				
$V_{OH}$ High-level output voltage	$I_{OH} = -20\ \mu\text{A}$	25°C	2.99			2.99			$\text{V}$	
		25°C	2.85			2.85				
		Full range	2.825			2.825				
		25°C	2.7			2.7				
$V_{OL}$ Low-level output voltage	$V_{IC} = 1.5\text{ V}$ , $I_{OL} = 50\ \mu\text{A}$	25°C	10			10			$\text{mV}$	
		25°C	100			100				
		Full range	150			150				
		25°C	200			200				
$A_{VD}$ Large-signal differential voltage amplification	$V_{IC} = 1.5\text{ V}$ , $V_O = 1\text{ to }2\text{ V}$	$R_L = 50\ \text{k}\Omega$ ‡	25°C	60	100		60	100	$\text{V}/\text{mV}$	
			Full range	30			30			
		$R_L = 1\ \text{M}\Omega$ ‡	25°C	100			100			
			Full range	300			300			
$r_{i(d)}$ Differential input resistance		25°C	$10^{12}$			$10^{12}$			$\Omega$	
$r_{i(c)}$ Common-mode input resistance		25°C	$10^{12}$			$10^{12}$			$\Omega$	
$C_{i(c)}$ Common-mode input capacitance	$f = 10\ \text{kHz}$ , N package	25°C	8			8			$\text{pF}$	
$z_o$ Closed-loop output impedance	$f = 100\ \text{kHz}$ , $A_V = 10$	25°C	270			270			$\Omega$	
CMRR Common-mode rejection ratio	$V_{IC} = 0\text{ to }1.7\text{ V}$ , $V_O = 1.5\text{ V}$ , $R_S = 50\ \Omega$	25°C	65	75		65	77	$\text{dB}$		
		Full range	60			60				
$k_{SVR}$ Supply voltage rejection ratio ( $\Delta V_{DD}/\Delta V_{IO}$ )	$V_{DD} = 2.7\text{ V to }8\text{ V}$ , $V_{IC} = V_{DD}/2$ , No load	25°C	80	95		80	100	$\text{dB}$		
		Full range	80			80				
$I_{DD}$ Supply current (four amplifiers)	$V_O = 1.5\text{ V}$ , No load	25°C	0.8	1		0.8	1	$\text{mA}$		
		Full range		1			1			

† Full range is  $-40^\circ\text{C}$  to  $85^\circ\text{C}$ .

‡ Referenced to 1.5 V

NOTE 4: Typical values are based on the input offset voltage shift observed through 500 hours of operating life test at  $T_A = 150^\circ\text{C}$  extrapolated to  $T_A = 25^\circ\text{C}$  using the Arrhenius equation and assuming an activation energy of 0.96 eV.



**TLV2264I operating characteristics at specified free-air temperature,  $V_{DD} = 3\text{ V}$**

PARAMETER	TEST CONDITIONS	$T_A$ †	TLV2264I			TLV2264AI			UNIT
			MIN	TYP	MAX	MIN	TYP	MAX	
SR	Slew rate at unity gain $V_O = 0.7\text{ V to }1.7\text{ V}$ , $R_L = 50\text{ k}\Omega$ ‡, $C_L = 100\text{ pF}$ ‡	25°C	0.35	0.55		0.35	0.55		V/ $\mu\text{s}$
		Full range	0.3			0.3			
$V_n$	Equivalent input noise voltage	$f = 10\text{ Hz}$	43			43			nV/ $\sqrt{\text{Hz}}$
		$f = 1\text{ kHz}$	12			12			
$V_{N(PP)}$	Peak-to-peak equivalent input noise voltage	$f = 0.1\text{ Hz to }1\text{ Hz}$	0.6			0.6			$\mu\text{V}$
		$f = 0.1\text{ Hz to }10\text{ Hz}$	1			1			
$I_n$	Equivalent input noise current	25°C	0.6			0.6			fA/ $\sqrt{\text{Hz}}$
THD + N	Total harmonic distortion plus noise $V_O = 0.5\text{ V to }2.5\text{ V}$ , $f = 20\text{ kHz}$ , $R_L = 50\text{ k}\Omega$ ‡	$A_V = 1$	0.03%			0.03%			
		$A_V = 10$	0.05%			0.05%			
	Gain-bandwidth product $f = 1\text{ kHz}$ , $C_L = 100\text{ pF}$ ‡	$R_L = 50\text{ k}\Omega$ ‡, 25°C	0.67			0.67			MHz
BOM	Maximum output-swing bandwidth $V_{O(PP)} = 1\text{ V}$ , $R_L = 50\text{ k}\Omega$ ‡	$A_V = 1$ , $C_L = 100\text{ pF}$ ‡, 25°C	395			395			kHz
$t_s$	Settling time $A_V = -1$ , Step = 1 V to 2 V, $R_L = 50\text{ k}\Omega$ ‡, $C_L = 100\text{ pF}$ ‡	To 0.1%	5.6			5.6			$\mu\text{s}$
		To 0.01%	12.5			12.5			
$\phi_m$	Phase margin at unity gain	$R_L = 50\text{ k}\Omega$ ‡, $C_L = 100\text{ pF}$ ‡, 25°C	55°			55°			
	Gain margin	25°C	11			11			dB

† Full range is  $-40^\circ\text{C}$  to  $85^\circ\text{C}$ .

‡ Referenced to 1.5 V

# TLV226x, TLV226xA Advanced LinCMOS™ RAIL-TO-RAIL OPERATIONAL AMPLIFIERS

SLOS186A – FEBRUARY 1997 – REVISED JULY 1999

**TLV2264I electrical characteristics at specified free-air temperature,  $V_{DD} = 5\text{ V}$  (unless otherwise noted)**

PARAMETER	TEST CONDITIONS	$T_A$ †	TLV2264I			TLV2264AI			UNIT
			MIN	TYP	MAX	MIN	TYP	MAX	
$V_{IO}$ Input offset voltage		25°C	300	2500		300	950	$\mu\text{V}$	
		Full range			3000		1500		
$\alpha_{VIO}$ Temperature coefficient of input offset voltage	$V_{DD} = \pm 2.5\text{ V}$ , $V_{IC} = 0$ , $V_O = 0$ , $R_S = 50\ \Omega$	25°C to 85°C	2			2			$\mu\text{V}/^\circ\text{C}$
Input offset voltage long-term drift (see Note 4)		25°C	0.003			0.003			$\mu\text{V}/\text{mo}$
$I_{IO}$ Input offset current		25°C	0.5			0.5			$\text{pA}$
		Full range			150			150	
$I_{IB}$ Input bias current	25°C	1			1			$\text{pA}$	
	Full range			150			150		
$V_{ICR}$ Common-mode input voltage range	$ V_{IO}  \leq 5\text{ mV}$ , $R_S = 50\ \Omega$	25°C	0 to 4	-0.3 to 4.2		0 to 4	-0.3 to 4.2	V	
		Full range	0 to 3.5			0 to 3.5			
$V_{OH}$ High-level output voltage	$I_{OH} = -20\ \mu\text{A}$	25°C	4.99			4.99			V
		25°C	4.85	4.94		4.85	4.94		
		Full range	4.82			4.82			
		25°C	4.7	4.85		4.7	4.85		
$V_{OL}$ Low-level output voltage	$V_{IC} = 2.5\text{ V}$ , $I_{OL} = 50\ \mu\text{A}$	25°C	0.01			0.01			V
		25°C	0.09	0.15		0.09	0.15		
		Full range	0.15			0.15			
		25°C	0.2	0.3		0.2	0.3		
$V_{OL}$ Low-level output voltage	$V_{IC} = 2.5\text{ V}$ , $I_{OL} = 500\ \mu\text{A}$	25°C	0.01			0.01			V
		25°C	0.09	0.15		0.09	0.15		
		Full range	0.15			0.15			
		25°C	0.2	0.3		0.2	0.3		
$V_{OL}$ Low-level output voltage	$V_{IC} = 2.5\text{ V}$ , $I_{OL} = 1\text{ mA}$	25°C	0.01			0.01			V
		25°C	0.09	0.15		0.09	0.15		
		Full range	0.15			0.15			
		25°C	0.2	0.3		0.2	0.3		
$A_{VD}$ Large-signal differential voltage amplification	$V_{IC} = 2.5\text{ V}$ , $V_O = 1\text{ V to }4\text{ V}$	$R_L = 50\text{ k}\Omega^\ddagger$	25°C	80	170		80	170	V/mV
			Full range	55			55		
		$R_L = 1\text{ M}\Omega^\ddagger$	25°C	550			550		
$r_{i(d)}$ Differential input resistance		25°C	$10^{12}$			$10^{12}$			$\Omega$
$r_{i(c)}$ Common-mode input resistance		25°C	$10^{12}$			$10^{12}$			$\Omega$
$c_{i(c)}$ Common-mode input capacitance	$f = 10\text{ kHz}$ , N package	25°C	8			8			pF
$z_o$ Closed-loop output impedance	$f = 100\text{ kHz}$ , $A_V = 10$	25°C	240			240			$\Omega$
CMRR Common-mode rejection ratio	$V_{IC} = 0\text{ to }2.7\text{ V}$ , $V_O = 2.5\text{ V}$ , $R_S = 50\ \Omega$	25°C	70	83		70	83	dB	
		Full range	70			70			
$k_{SVR}$ Supply voltage rejection ratio ( $\Delta V_{DD}/\Delta V_{IO}$ )	$V_{DD} = 4.4\text{ V to }8\text{ V}$ , $V_{IC} = V_{DD}/2$ , No load	25°C	80	95		80	95	dB	
		Full range	80			80			
$I_{DD}$ Supply current (four amplifiers)	$V_O = 2.5\text{ V}$ , No load	25°C	0.8	1		0.8	1	mA	
		Full range	1			1			

† Full range is  $-40^\circ\text{C}$  to  $85^\circ\text{C}$ .

‡ Referenced to 2.5 V

NOTE 4: Typical values are based on the input offset voltage shift observed through 500 hours of operating life test at  $T_A = 150^\circ\text{C}$  extrapolated to  $T_A = 25^\circ\text{C}$  using the Arrhenius equation and assuming an activation energy of 0.96 eV.



**TLV2264I operating characteristics at specified free-air temperature,  $V_{DD} = 5\text{ V}$**

PARAMETER	TEST CONDITIONS	$T_A$ †	TLV2264I			TLV2264AI			UNIT
			MIN	TYP	MAX	MIN	TYP	MAX	
SR	Slew rate at unity gain $V_O = 1.4\text{ V to }2.6\text{ V}, R_L = 50\text{ k}\Omega\ddagger, C_L = 100\text{ pF}\ddagger$	25°C	0.35	0.55		0.35	0.55	$\text{V}/\mu\text{s}$	
		Full range	0.3			0.3			
$V_n$	Equivalent input noise voltage	f = 10 Hz	40			40			$\text{nV}/\sqrt{\text{Hz}}$
		f = 1 kHz	12			12			
$V_{N(PP)}$	Peak-to-peak equivalent input noise voltage	f = 0.1 Hz to 1 Hz	0.7			0.7			$\mu\text{V}$
		f = 0.1 Hz to 10 Hz	1.3			1.3			
$I_n$	Equivalent input noise current	25°C	0.6			0.6			$\text{fA}/\sqrt{\text{Hz}}$
THD + N	Total harmonic distortion plus noise $V_O = 0.5\text{ V to }2.5\text{ V}, f = 20\text{ kHz}, R_L = 50\text{ k}\Omega\ddagger$	$A_V = 1$	0.017%			0.017%			
		$A_V = 10$	0.03%			0.03%			
	Gain-bandwidth product f = 50 kHz, $R_L = 50\text{ k}\Omega\ddagger, C_L = 100\text{ pF}\ddagger$	25°C	0.71			0.71			MHz
BOM	Maximum output-swing bandwidth $V_{O(PP)} = 2\text{ V}, R_L = 50\text{ k}\Omega\ddagger, A_V = 1, C_L = 100\text{ pF}\ddagger$	25°C	185			185			kHz
$t_s$	Settling time $A_V = -1, \text{ Step} = 0.5\text{ V to }2.5\text{ V}, R_L = 50\text{ k}\Omega\ddagger, C_L = 100\text{ pF}\ddagger$	To 0.1%	6.4			6.4			$\mu\text{s}$
		To 0.01%	14.1			14.1			
$\phi_m$	Phase margin at unity gain $R_L = 50\text{ k}\Omega\ddagger, C_L = 100\text{ pF}\ddagger$	25°C	56°			56°			
	Gain margin	25°C	11			11			dB

† Full range is – 40°C to 85°C.

‡ Referenced to 2.5 V

# TLV226x, TLV226xA Advanced LinCMOS™ RAIL-TO-RAIL OPERATIONAL AMPLIFIERS

SLOS186A – FEBRUARY 1997 – REVISED JULY 1999

## TLV2262Q and TLV2262M electrical characteristics at specified free-air temperature, $V_{DD} = 3\text{ V}$ (unless otherwise noted)

PARAMETER	TEST CONDITIONS	$T_A$ †	TLV2262Q, TLV2262M			TLV2262AQ, TLV2262AM			UNIT	
			MIN	TYP	MAX	MIN	TYP	MAX		
$V_{IO}$ Input offset voltage		25°C	300	2500		300	950	$\mu\text{V}$		
		Full range		3000		1500				
$\alpha V_{IO}$ Temperature coefficient of input offset voltage		25°C to 125°C	2			2			$\mu\text{V}/^\circ\text{C}$	
Input offset voltage long-term drift (see Note 4)	$V_{DD\pm} = \pm 1.5\text{ V}$ , $V_{IC} = 0$ , $V_O = 0$ , $R_S = 50\ \Omega$	25°C	0.003			0.003			$\mu\text{V}/\text{mo}$	
$I_{IO}$ Input offset current		25°C	0.5			0.5			pA	
		125°C	500			500				
$I_{IB}$ Input bias current		25°C	1			1			pA	
		125°C	500			500				
$V_{ICR}$ Common-mode input voltage range		$R_S = 50\ \Omega$ , $ V_{IO}  \leq 5\text{ mV}$	25°C	0 to 2	-0.3 to 2.2		0 to 2	-0.3 to 2.2	V	
	Full range		0 to 1.7			0 to 1.7				
$V_{OH}$ High-level output voltage	$I_{OH} = -20\ \mu\text{A}$	25°C	2.99			2.99			V	
	$I_{OH} = -100\ \mu\text{A}$	25°C	2.85			2.85				
		Full range	2.82			2.82				
	$I_{OH} = -400\ \mu\text{A}$	25°C	2.7			2.7				
Full range		2.55			2.55					
$V_{OL}$ Low-level output voltage	$V_{IC} = 1.5\text{ V}$ , $I_{OL} = 50\ \mu\text{A}$	25°C	10			10			mV	
	$V_{IC} = 1.5\text{ V}$ , $I_{OL} = 500\ \mu\text{A}$	25°C	100	150		100	150			
		Full range	165			165				
	$V_{IC} = 1.5\text{ V}$ , $I_{OL} = 1\text{ mA}$	25°C	200	300		200	300			
Full range		300			300					
$A_{VD}$ Large-signal differential voltage amplification	$V_{IC} = 1.5\text{ V}$ , $V_O = 1\text{ V to }2\text{ V}$	$R_L = 50\ \text{k}\Omega$ ‡	25°C	60	100		60	100	V/mV	
		$R_L = 1\ \text{M}\Omega$ ‡	Full range	25			25			
			25°C	100			100			
$r_{i(d)}$ Differential input resistance		25°C	$10^{12}$			$10^{12}$			$\Omega$	
$r_{i(c)}$ Common-mode input resistance		25°C	$10^{12}$			$10^{12}$			$\Omega$	
$C_{i(c)}$ Common-mode input capacitance	$f = 10\ \text{kHz}$ , P package	25°C	8			8			pF	
$Z_o$ Closed-loop output impedance	$f = 100\ \text{kHz}$ , $A_V = 10$	25°C	270			270			$\Omega$	
CMRR Common-mode rejection ratio	$V_{IC} = 0\text{ to }1.7\text{ V}$ , $V_O = 1.5\text{ V}$ , $R_S = 50\ \Omega$	25°C	65	75		65	77	dB		
		Full range	60			60				
$k_{SVR}$ Supply voltage rejection ratio ( $\Delta V_{DD}/\Delta V_{IO}$ )	$V_{DD} = 2.7\text{ V to }8\text{ V}$ , $V_{IC} = V_{DD}/2$ , No load	25°C	80	95		80	100	dB		
		Full range	80			80				

† Full range is  $-40^\circ\text{C}$  to  $125^\circ\text{C}$  for Q level part,  $-55^\circ\text{C}$  to  $125^\circ\text{C}$  for M level part.

‡ Referenced to 1.5 V

NOTE 4: Typical values are based on the input offset voltage shift observed through 500 hours of operating life test at  $T_A = 150^\circ\text{C}$  extrapolated to  $T_A = 25^\circ\text{C}$  using the Arrhenius equation and assuming an activation energy of 0.96 eV.



**TLV2262Q and TLV2262M electrical characteristics at specified free-air temperature,  $V_{DD} = 3\text{ V}$  (unless otherwise noted) (continued)**

PARAMETER	TEST CONDITIONS	$T_A$ †	TLV2262Q, TLV2262M			TLV2262AQ, TLV2262AM			UNIT
			MIN	TYP	MAX	MIN	TYP	MAX	
$I_{DD}$ Supply current	$V_O = 1.5\text{ V}$ , No load	25°C	400	500		400	500	$\mu\text{A}$	
		Full range		500		500			

† Full range is  $-40^\circ\text{C}$  to  $125^\circ\text{C}$  for Q level part,  $-55^\circ\text{C}$  to  $125^\circ\text{C}$  for M level part.

**TLV2262Q and TLV2262M operating characteristics at specified free-air temperature,  $V_{DD} = 3\text{ V}$**

PARAMETER	TEST CONDITIONS	$T_A$ †	TLV2262Q, TLV2262M			TLV2262AQ, TLV2262AM			UNIT
			MIN	TYP	MAX	MIN	TYP	MAX	
SR Slew rate at unity gain	$V_O = 0.5\text{ V}$ to $1.7\text{ V}$ , $R_L = 50\text{ k}\Omega$ ‡, $C_L = 100\text{ pF}$ ‡	25°C	0.35	0.55		0.35	0.55	$\text{V}/\mu\text{s}$	
		Full range	0.25			0.25			
$V_n$ Equivalent input noise voltage	$f = 10\text{ Hz}$	25°C		43			43	$\text{nV}/\sqrt{\text{Hz}}$	
	$f = 1\text{ kHz}$	25°C		12			12		
$V_{N(PP)}$ Peak-to-peak equivalent input noise voltage	$f = 0.1\text{ Hz}$ to $1\text{ Hz}$	25°C		0.6			0.6	$\mu\text{V}$	
	$f = 0.1\text{ Hz}$ to $10\text{ Hz}$	25°C		1			1		
$I_n$ Equivalent input noise current		25°C		0.6			0.6	$\text{fA}/\sqrt{\text{Hz}}$	
THD + N Total harmonic distortion plus noise	$V_O = 0.5\text{ V}$ to $2.5\text{ V}$ , $f = 20\text{ kHz}$ , $R_L = 50\text{ k}\Omega$ ‡	$A_V = 1$		0.03%			0.03%		
		$A_V = 10$		0.05%			0.05%		
Gain-bandwidth product	$f = 1\text{ kHz}$ , $C_L = 100\text{ pF}$ ‡	$R_L = 50\text{ k}\Omega$ ‡,	25°C		0.67		0.67	MHz	
$B_{OM}$ Maximum output-swing bandwidth	$V_{O(PP)} = 1\text{ V}$ , $R_L = 50\text{ k}\Omega$ ‡,	$A_V = 1$ , $C_L = 100\text{ pF}$ ‡	25°C		395		395	kHz	
$t_s$ Settling time	$A_V = -1$ , Step = $1\text{ V}$ to $2\text{ V}$ , $R_L = 50\text{ k}\Omega$ ‡, $C_L = 100\text{ pF}$ ‡	$T_o = 0.1\%$	25°C		5.6		5.6	$\mu\text{s}$	
		$T_o = 0.01\%$			12.5		12.5		
$\phi_m$ Phase margin at unity gain	$R_L = 50\text{ k}\Omega$ ‡,	$C_L = 100\text{ pF}$ ‡	25°C		55°		55°		
Gain margin			25°C		11		11	dB	

† Full range is  $-40^\circ\text{C}$  to  $125^\circ\text{C}$  for Q level part,  $-55^\circ\text{C}$  to  $125^\circ\text{C}$  for M level part.

‡ Referenced to  $1.5\text{ V}$

# TLV226x, TLV226xA Advanced LinCMOS™ RAIL-TO-RAIL OPERATIONAL AMPLIFIERS

SLOS186A – FEBRUARY 1997 – REVISED JULY 1999

**TLV2262Q and TLV2262M electrical characteristics at specified free-air temperature,  $V_{DD} = 5\text{ V}$  (unless otherwise noted)**

PARAMETER	TEST CONDITIONS	$T_A$ †	TLV2262Q, TLV2262M			TLV2262AQ, TLV2262AM			UNIT
			MIN	TYP	MAX	MIN	TYP	MAX	
$V_{IO}$ Input offset voltage	$V_{DD} \pm \pm 2.5\text{ V}$ , $V_{IC} = 0$ , $V_O = 0$ , $R_S = 50\ \Omega$	25°C	300	2500		300	950	$\mu\text{V}$	
		Full range		3000		1500			
$\alpha_{VIO}$ Temperature coefficient of input offset voltage		25°C to 125°C	2			2		$\mu\text{V}/^\circ\text{C}$	
Input offset voltage long-term drift (see Note 4)		25°C	0.003			0.003		$\mu\text{V}/\text{mo}$	
$I_{IO}$ Input offset current		25°C	0.5			0.5		$\text{pA}$	
		125°C		500		500			
$I_{IB}$ Input bias current	25°C	1			1		$\text{pA}$		
	125°C		500		500				
$V_{ICR}$ Common-mode input voltage range	$ V_{IO}  \leq 5\text{ mV}$ , $R_S = 50\ \Omega$	25°C	0 to 4	-0.3 to 4.2		0 to 4	-0.3 to 4.2	V	
		Full range	0 to 3.5			0 to 3.5			
$V_{OH}$ High-level output voltage	$I_{OH} = -20\ \mu\text{A}$ $I_{OH} = -100\ \mu\text{A}$ $I_{OH} = -400\ \mu\text{A}$	25°C	4.99			4.99		V	
		25°C	4.85	4.94		4.85	4.94		
		Full range	4.82			4.82			
		25°C	4.7	4.85		4.7	4.85		
$V_{OL}$ Low-level output voltage	$V_{IC} = 2.5\text{ V}$ , $I_{OL} = 50\ \mu\text{A}$ $V_{IC} = 2.5\text{ V}$ , $I_{OL} = 500\ \mu\text{A}$ $V_{IC} = 2.5\text{ V}$ , $I_{OL} = 1\text{ mA}$	25°C	0.01			0.01		V	
		25°C	0.09	0.15		0.09	0.15		
		Full range		0.15			0.15		
		25°C	0.2	0.3		0.2	0.3		
$A_{VD}$ Large-signal differential voltage amplification	$V_{IC} = 2.5\text{ V}$ , $V_O = 1\text{ V to }4\text{ V}$ $R_L = 50\text{ k}\Omega$ ‡ $R_L = 1\text{ M}\Omega$ ‡	25°C	80	170		80	170	V/mV	
		Full range	50			50			
		25°C	550			550			
$r_{i(d)}$ Differential input resistance		25°C	$10^{12}$			$10^{12}$	$\Omega$		
$r_{i(c)}$ Common-mode input resistance		25°C	$10^{12}$			$10^{12}$	$\Omega$		
$C_{i(c)}$ Common-mode input capacitance	$f = 10\text{ kHz}$ , P package	25°C	8			8	pF		
$z_o$ Closed-loop output impedance	$f = 100\text{ kHz}$ , $A_V = 10$	25°C	240			240	$\Omega$		
CMRR Common-mode rejection ratio	$V_{IC} = 0\text{ to }2.7\text{ V}$ , $V_O = 2.5\text{ V}$ , $R_S = 50\ \Omega$	25°C	70	83		70	83	dB	
		Full range	70			70			
$k_{SVR}$ Supply voltage rejection ratio ( $\Delta V_{DD}/\Delta V_{IO}$ )	$V_{DD} = 4.4\text{ V to }8\text{ V}$ , $V_{IC} = V_{DD}/2$ , No load	25°C	80	95		80	95	dB	
		Full range	80			80			

† Full range is -40°C to 125°C for Q level part, -55°C to 125°C for M level part.

‡ Referenced to 2.5 V

NOTE 4: Typical values are based on the input offset voltage shift observed through 500 hours of operating life test at  $T_A = 150^\circ\text{C}$  extrapolated to  $T_A = 25^\circ\text{C}$  using the Arrhenius equation and assuming an activation energy of 0.96 eV.





**TLV2262Q and TLV2262M electrical characteristics at specified free-air temperature,  $V_{DD} = 5\text{ V}$  (unless otherwise noted) (continued)**

PARAMETER	TEST CONDITIONS	$T_A$ †	TLV2262Q, TLV2262M			TLV2262AQ, TLV2262AM			UNIT
			MIN	TYP	MAX	MIN	TYP	MAX	
$I_{DD}$ Supply current	$V_O = 2.5\text{ V}$ , No load	25°C	400	500		400	500	$\mu\text{A}$	
		Full range		500			500		

† Full range is  $-40^\circ\text{C}$  to  $125^\circ\text{C}$  for Q level part,  $-55^\circ\text{C}$  to  $125^\circ\text{C}$  for M level part.

**TLV2262Q and TLV2262M operating characteristics at specified free-air temperature,  $V_{DD} = 5\text{ V}$**

PARAMETER	TEST CONDITIONS	$T_A$ †	TLV2262Q, TLV2262M			TLV2262AQ, TLV2262AM			UNIT
			MIN	TYP	MAX	MIN	TYP	MAX	
SR Slew rate at unity gain	$V_O = 0.5\text{ V}$ to $3.5\text{ V}$ , $C_L = 100\text{ pF}^\ddagger$ , $R_L = 50\text{ k}\Omega^\ddagger$	25°C	0.35	0.55		0.35	0.55	$\text{V}/\mu\text{s}$	
		Full range	0.25			0.25			
$V_n$ Equivalent input noise voltage	$f = 10\text{ Hz}$ $f = 1\text{ kHz}$	25°C	40			40		$\text{nV}/\sqrt{\text{Hz}}$	
		25°C	12			12			
$V_{N(PP)}$ Peak-to-peak equivalent input noise voltage	$f = 0.1\text{ Hz}$ to $1\text{ Hz}$ $f = 0.1\text{ Hz}$ to $10\text{ Hz}$	25°C	0.7			0.7		$\mu\text{V}$	
		25°C	1.3			1.3			
$I_n$ Equivalent input noise current		25°C	0.6			0.6		$\text{fA}/\sqrt{\text{Hz}}$	
THD + N Total harmonic distortion plus noise	$V_O = 0.5\text{ V}$ to $2.5\text{ V}$ , $f = 20\text{ kHz}$ , $R_L = 50\text{ k}\Omega^\ddagger$	$A_V = 1$	0.017%			0.017%			
		$A_V = 10$	0.03%			0.03%			
Gain-bandwidth product	$f = 50\text{ kHz}$ , $C_L = 100\text{ pF}^\ddagger$ , $R_L = 50\text{ k}\Omega^\ddagger$	25°C	0.71			0.71			MHz
$B_{OM}$ Maximum output-swing bandwidth	$V_{O(PP)} = 2\text{ V}$ , $R_L = 50\text{ k}\Omega^\ddagger$ , $A_V = 1$ , $C_L = 100\text{ pF}^\ddagger$	25°C	185			185			kHz
$t_s$ Settling time	$A_V = -1$ , Step = $0.5\text{ V}$ to $2.5\text{ V}$ , $R_L = 50\text{ k}\Omega^\ddagger$ , $C_L = 100\text{ pF}^\ddagger$	To 0.1%	6.4			6.4			$\mu\text{s}$
		To 0.01%	14.1			14.1			
$\phi_m$ Phase margin at unity gain	$R_L = 50\text{ k}\Omega^\ddagger$ , $C_L = 100\text{ pF}^\ddagger$	25°C	56°			56°			
		25°C	11			11			
Gain margin		25°C	11			11			dB

† Full range is  $-40^\circ\text{C}$  to  $125^\circ\text{C}$  for Q level part,  $-55^\circ\text{C}$  to  $125^\circ\text{C}$  for M level part.

‡ Referenced to  $2.5\text{ V}$

# TLV226x, TLV226xA Advanced LinCMOS™ RAIL-TO-RAIL OPERATIONAL AMPLIFIERS

SLOS186A – FEBRUARY 1997 – REVISED JULY 1999

## TLV2264Q and TLV2264M electrical characteristics at specified free-air temperature, $V_{DD} = 3\text{ V}$ (unless otherwise noted)

PARAMETER	TEST CONDITIONS	$T_A$ †	TLV2264Q, TLV2264M			TLV2264AQ, TLV2264AM			UNIT	
			MIN	TYP	MAX	MIN	TYP	MAX		
$V_{IO}$ Input offset voltage		25°C	300	2500		300	950	$\mu\text{V}$		
		Full range			3000		1500			
$\alpha_{VIO}$ Temperature coefficient of input offset voltage	$V_{DD} = \pm 1.5\text{ V}$ , $V_{IC} = 0$ , $V_O = 0$ , $R_S = 50\ \Omega$	25°C to 125°C	2			2			$\mu\text{V}/^\circ\text{C}$	
Input offset voltage long-term drift (see Note 4)		25°C	0.003			0.003			$\mu\text{V}/\text{mo}$	
$I_{IO}$ Input offset current		25°C	0.5			0.5			$\text{pA}$	
		125°C		500			500			
$I_{IB}$ Input bias current	25°C	1			1			$\text{pA}$		
	125°C		500			500				
$V_{ICR}$ Common-mode input voltage range	$R_S = 50\ \Omega$ , $ V_{IO}  \leq 5\text{ mV}$	25°C	0 to 2	-0.3 to 2.2		0 to 2	-0.3 to 2.2	V		
		Full range	0 to 1.7			0 to 1.7				
$V_{OH}$ High-level output voltage	$I_{OH} = -20\ \mu\text{A}$	25°C	2.99			2.99			V	
		25°C	2.85			2.85				
		Full range	2.82			2.82				
		25°C	2.7			2.7				
$V_{OL}$ Low-level output voltage	$V_{IC} = 1.5\text{ V}$ , $I_{OL} = 50\ \mu\text{A}$	25°C	10			10			mV	
		25°C	100	150		100	150			
		Full range	150			150				
		25°C	200	300		200	300			
AVD Large-signal differential voltage amplification	$V_{IC} = 1.5\text{ V}$ , $V_O = 1\text{ V to }2\text{ V}$	$R_L = 50\ \text{k}\Omega$ ‡	25°C	60	100		60	100	V/mV	
			Full range	25			25			
		$R_L = 1\ \text{M}\Omega$ ‡	25°C	100			100			
			Full range							
$r_{i(d)}$ Differential input resistance		25°C	$10^{12}$			$10^{12}$			$\Omega$	
$r_{i(c)}$ Common-mode input resistance		25°C	$10^{12}$			$10^{12}$			$\Omega$	
$C_{i(c)}$ Common-mode input capacitance	$f = 10\ \text{kHz}$ , N package	25°C	8			8			pF	
$z_o$ Closed-loop output impedance	$f = 100\ \text{kHz}$ , $A_V = 10$	25°C	270			270			$\Omega$	
CMRR Common-mode rejection ratio	$V_{IC} = 0\text{ to }1.7\text{ V}$ , $V_O = 1.5\text{ V}$ , $R_S = 50\ \Omega$	25°C	65	75		65	77	dB		
		Full range	60			60				
$k_{SVR}$ Supply voltage rejection ratio ( $\Delta V_{DD}/\Delta V_{IO}$ )	$V_{DD} = 2.7\text{ V to }8\text{ V}$ , $V_{IC} = V_{DD}/2$ , No load	25°C	80	95		80	100	dB		
		Full range	80			80				

† Full range is  $-40^\circ\text{C}$  to  $125^\circ\text{C}$  for Q level part,  $-55^\circ\text{C}$  to  $125^\circ\text{C}$  for M level part.

‡ Referenced to 1.5 V

NOTE 4: Typical values are based on the input offset voltage shift observed through 500 hours of operating life test at  $T_A = 150^\circ\text{C}$  extrapolated to  $T_A = 25^\circ\text{C}$  using the Arrhenius equation and assuming an activation energy of 0.96 eV.



**TLV2264Q and TLV2264M electrical characteristics at specified free-air temperature,  $V_{DD} = 3\text{ V}$  (unless otherwise noted) (continued)**

PARAMETER	TEST CONDITIONS	$T_A$ †	TLV2264Q, TLV2264M			TLV2264AQ, TLV2264AM			UNIT
			MIN	TYP	MAX	MIN	TYP	MAX	
$I_{DD}$	Supply current (four amplifiers) $V_O = 1.5\text{ V}$ , No load	25°C	0.8		1	0.8		1	mA
		Full range			1			1	

† Full range is  $-40^\circ\text{C}$  to  $125^\circ\text{C}$  for Q level part,  $-55^\circ\text{C}$  to  $125^\circ\text{C}$  for M level part.

**TLV2264Q and TLV2264M operating characteristics at specified free-air temperature,  $V_{DD} = 3\text{ V}$**

PARAMETER	TEST CONDITIONS	$T_A$ †	TLV2264Q, TLV2264M			TLV2264AQ, TLV2264AM			UNIT
			MIN	TYP	MAX	MIN	TYP	MAX	
SR	Slew rate at unity gain $V_O = 0.5\text{ V}$ to $1.7\text{ V}$ , $R_L = 50\text{ k}\Omega$ ‡, $C_L = 100\text{ pF}$ ‡	25°C	0.35	0.55		0.35	0.55		$\text{V}/\mu\text{s}$
		Full range	0.25			0.25			
$V_n$	Equivalent input noise voltage $f = 10\text{ Hz}$ $f = 1\text{ kHz}$	25°C	43			43			$\text{nV}/\sqrt{\text{Hz}}$
		25°C	12			12			
$V_{N(PP)}$	Peak-to-peak equivalent input noise voltage $f = 0.1\text{ Hz}$ to $1\text{ Hz}$ $f = 0.1\text{ Hz}$ to $10\text{ Hz}$	25°C	0.6			0.6			$\mu\text{V}$
		25°C	1			1			
$I_n$	Equivalent input noise current	25°C	0.6			0.6			$\text{fA}/\sqrt{\text{Hz}}$
THD + N	Total harmonic distortion plus noise $V_O = 0.5\text{ V}$ to $2.5\text{ V}$ , $f = 20\text{ kHz}$ , $R_L = 50\text{ k}\Omega$ ‡	25°C	$A_V = 1$		0.03%		0.03%		
			$A_V = 10$		0.05%		0.05%		
	Gain-bandwidth product $f = 1\text{ kHz}$ , $C_L = 100\text{ pF}$ ‡	25°C	0.67			0.67			MHz
$B_{OM}$	Maximum output-swing bandwidth $V_{O(PP)} = 1\text{ V}$ , $R_L = 50\text{ k}\Omega$ ‡, $A_V = 1$ , $C_L = 100\text{ pF}$ ‡	25°C	395			395			kHz
$t_s$	Settling time $A_V = -1$ , Step = $1\text{ V}$ to $2\text{ V}$ , $R_L = 50\text{ k}\Omega$ ‡, $C_L = 100\text{ pF}$ ‡	25°C	To 0.1%		5.6		5.6		$\mu\text{s}$
			To 0.01%		12.5		12.5		
$\phi_m$	Phase margin at unity gain $R_L = 50\text{ k}\Omega$ ‡, $C_L = 100\text{ pF}$ ‡	25°C	55°			55°			
		25°C	11			11			

† Full range is  $-40^\circ\text{C}$  to  $125^\circ\text{C}$  for Q level part,  $-55^\circ\text{C}$  to  $125^\circ\text{C}$  for M level part.

‡ Referenced to  $1.5\text{ V}$

**TLV226x, TLV226xA**  
**Advanced LinCMOS™ RAIL-TO-RAIL**  
**OPERATIONAL AMPLIFIERS**

SLOS186A – FEBRUARY 1997 – REVISED JULY 1999

**TLV2264Q and TLV2264M electrical characteristics at specified free-air temperature,  $V_{DD} = 5\text{ V}$  (unless otherwise noted)**

PARAMETER	TEST CONDITIONS	$T_A$ †	TLV2264Q, TLV2264M			TLV2264AQ, TLV2264AM			UNIT
			MIN	TYP	MAX	MIN	TYP	MAX	
$V_{IO}$ Input offset voltage		25°C	300		2500	300		950	$\mu\text{V}$
		Full range	3000			1500			
$\alpha_{VIO}$ Temperature coefficient of input offset voltage	$V_{DD} \pm = \pm 2.5\text{ V}$ , $V_{IC} = 0$ , $V_O = 0$ , $R_S = 50\ \Omega$	25°C to 125°C	2			2			$\mu\text{V}/^\circ\text{C}$
Input offset voltage long-term drift (see Note 4)		25°C	0.003			0.003			$\mu\text{V}/\text{mo}$
$I_{IO}$ Input offset current		25°C	0.5			0.5			$\text{pA}$
		125°C	500			500			
$I_{IB}$ Input bias current	25°C	1			1			$\text{pA}$	
	125°C	500			500				
$V_{ICR}$ Common-mode input voltage range	$ V_{IO}  \leq 5\text{ mV}$ , $R_S = 50\ \Omega$	25°C	0 to 4	-0.3 to 4.2		0 to 4	-0.3 to 4.2	V	
		Full range	0 to 3.5		0 to 3.5				
$V_{OH}$ High-level output voltage	$I_{OH} = -20\ \mu\text{A}$ $I_{OH} = -100\ \mu\text{A}$ $I_{OH} = -400\ \mu\text{A}$	25°C	4.99		4.99		V		
		25°C	4.85	4.94	4.85	4.94			
		Full range	4.82		4.82				
		25°C	4.7	4.85	4.7	4.85			
$V_{OL}$ Low-level output voltage	$V_{IC} = 2.5\text{ V}$ , $I_{OL} = 50\ \mu\text{A}$ $V_{IC} = 2.5\text{ V}$ , $I_{OL} = 500\ \mu\text{A}$ $V_{IC} = 2.5\text{ V}$ , $I_{OL} = 1\text{ mA}$	25°C	0.01		0.01		V		
		25°C	0.09	0.15	0.09	0.15			
		Full range	0.15		0.15				
		25°C	0.2	0.3	0.2	0.3			
$A_{VD}$ Large-signal differential voltage amplification	$V_{IC} = 2.5\text{ V}$ , $V_O = 1\text{ V to }4\text{ V}$	$R_L = 50\ \text{k}\Omega$ ‡	25°C	80	170	80	170	V/mV	
			Full range	50		50			
		$R_L = 1\ \text{M}\Omega$ ‡	25°C	550			550		
$r_{i(d)}$ Differential input resistance		25°C	$10^{12}$			$10^{12}$		$\Omega$	
$r_{i(c)}$ Common-mode input resistance		25°C	$10^{12}$			$10^{12}$		$\Omega$	
$C_{i(c)}$ Common-mode input capacitance	$f = 10\ \text{kHz}$ , N package	25°C	8			8		pF	
$z_o$ Closed-loop output impedance	$f = 100\ \text{kHz}$ , $A_V = 10$	25°C	240			240		$\Omega$	
CMRR Common-mode rejection ratio	$V_{IC} = 0\text{ to }2.7\text{ V}$ , $V_O = 2.5\text{ V}$ , $R_S = 50\ \Omega$	25°C	70	83	70	83	dB		
		Full range	70		70				
$k_{SVR}$ Supply voltage rejection ratio ( $\Delta V_{DD}/\Delta V_{IO}$ )	$V_{DD} = 4.4\text{ V to }8\text{ V}$ , $V_{IC} = V_{DD}/2$ , No load	25°C	80	95	80	95	dB		
		Full range	80		80				

† Full range is  $-40^\circ\text{C}$  to  $125^\circ\text{C}$  for Q level part,  $-55^\circ\text{C}$  to  $125^\circ\text{C}$  for M level part.

‡ Referenced to 2.5 V

NOTE 4: Typical values are based on the input offset voltage shift observed through 500 hours of operating life test at  $T_A = 150^\circ\text{C}$  extrapolated to  $T_A = 25^\circ\text{C}$  using the Arrhenius equation and assuming an activation energy of 0.96 eV.



**TLV2264Q and TLV2264M electrical characteristics at specified free-air temperature,  $V_{DD} = 5\text{ V}$  (unless otherwise noted) (continued)**

PARAMETER	TEST CONDITIONS	$T_A$ †	TLV2264Q, TLV2264M			TLV2264AQ, TLV2264AM			UNIT
			MIN	TYP	MAX	MIN	TYP	MAX	
$I_{DD}$	Supply current (four amplifiers) $V_O = 2.5\text{ V}$ , No load	25°C	0.8		1	0.8		1	mA
		Full range			1			1	

† Full range is  $-40^\circ\text{C}$  to  $125^\circ\text{C}$  for Q level part,  $-55^\circ\text{C}$  to  $125^\circ\text{C}$  for M level part.

**TLV2264Q and TLV2264M operating characteristics at specified free-air temperature,  $V_{DD} = 5\text{ V}$**

PARAMETER	TEST CONDITIONS	$T_A$ †	TLV2264Q, TLV2264M			TLV2264AQ, TLV2264AM			UNIT
			MIN	TYP	MAX	MIN	TYP	MAX	
SR	Slew rate at unity gain $V_O = 0.5\text{ V}$ to $3.5\text{ V}$ , $R_L = 50\text{ k}\Omega$ ‡, $C_L = 100\text{ pF}$ ‡	25°C	0.35	0.55		0.35	0.55		V/ $\mu\text{s}$
		Full range	0.25			0.25			
$V_n$	Equivalent input noise voltage	f = 10 Hz	40			40			nV/ $\sqrt{\text{Hz}}$
		25°C	12			12			
$V_{N(PP)}$	Peak-to-peak equivalent input noise voltage	f = 0.1 Hz to 1 Hz	0.7			0.7			$\mu\text{V}$
		25°C	1.3			1.3			
$I_n$	Equivalent input noise current	25°C	0.6			0.6		fA/ $\sqrt{\text{Hz}}$	
THD + N	Total harmonic distortion plus noise $V_O = 0.5\text{ V}$ to $2.5\text{ V}$ , f = 20 kHz, $R_L = 50\text{ k}\Omega$ ‡	$A_V = 1$	0.017%			0.017%			
		25°C	0.03%			0.03%			
	Gain-bandwidth product	f = 50 kHz, $C_L = 100\text{ pF}$ ‡	0.71			0.71		MHz	
BOM	Maximum output-swing bandwidth $V_{O(PP)} = 2\text{ V}$ , $R_L = 50\text{ k}\Omega$ ‡, $A_V = 1$ , $C_L = 100\text{ pF}$ ‡	25°C	185			185		kHz	
$t_s$	Settling time $A_V = -1$ , Step = 0.5 V to 2.5 V, $R_L = 50\text{ k}\Omega$ ‡, $C_L = 100\text{ pF}$ ‡	To 0.1%	6.4			6.4		$\mu\text{s}$	
		25°C	14.1			14.1			
$\phi_m$	Phase margin at unity gain $R_L = 50\text{ k}\Omega$ ‡, $C_L = 100\text{ pF}$ ‡	25°C	56°			56°			
		25°C	11			11		dB	

† Full range is  $-40^\circ\text{C}$  to  $125^\circ\text{C}$  for Q level part,  $-55^\circ\text{C}$  to  $125^\circ\text{C}$  for M level part.

‡ Referenced to 2.5 V

**TLV226x, TLV226xA**  
**Advanced LinCMOS™ RAIL-TO-RAIL**  
**OPERATIONAL AMPLIFIERS**

SLOS186A – FEBRUARY 1997 – REVISED JULY 1999

**TYPICAL CHARACTERISTICS**

**Table of Graphs**

		<b>FIGURE</b>
$V_{IO}$	Input offset voltage	Distribution vs Common-mode voltage 2 – 5 6, 7
$\alpha V_{IO}$	Input offset voltage temperature coefficient	Distribution 8 – 11
$I_{IB}/I_{IO}$	Input bias and input offset currents	vs Free-air temperature 12
$V_I$	Input voltage	vs Supply voltage vs Free-air temperature 13 14
$V_{OH}$	High-level output voltage	vs High-level output current 15, 18
$V_{OL}$	Low-level output voltage	vs Low-level output current 16, 17, 19
$V_{O(PP)}$	Maximum peak-to-peak output voltage	vs Frequency 20
$I_{OS}$	Short-circuit output current	vs Supply voltage vs Free-air temperature 21 22
$V_{ID}$	Differential input voltage	vs Output voltage 23, 24
$A_{VD}$	Differential voltage amplification	vs Load resistance 25
$A_{VD}$	Large-signal differential voltage amplification	vs Frequency vs Free-air temperature 26, 27 28, 29
$z_o$	Output impedance	vs Frequency 30, 31
$CMRR$	Common-mode rejection ratio	vs Frequency vs Free-air temperature 32 33
$k_{SVR}$	Supply-voltage rejection ratio	vs Frequency vs Free-air temperature 34, 35 36, 37
$I_{DD}$	Supply current	vs Free-air temperature 38, 39
$SR$	Slew rate	vs Load capacitance vs Free-air temperature 40 41
$V_O$	Inverting large-signal pulse response	42, 43
$V_O$	Voltage-follower large-signal pulse response	44, 45
$V_O$	Inverting small-signal pulse response	46, 47
$V_O$	Voltage-follower small-signal pulse response	48, 49
$V_n$	Equivalent input noise voltage	vs Frequency 50, 51
	Input noise voltage	Over a 10-second period 52
	Integrated noise voltage	vs Frequency 53
$THD + N$	Total harmonic distortion plus noise	vs Frequency 54
	Gain-bandwidth product	vs Supply voltage vs Free-air temperature 55 56
$\phi_m$	Phase margin	vs Frequency vs Load capacitance 26, 27 57
	Gain margin	vs Load capacitance 58
$B_1$	Unity-gain bandwidth	vs Load capacitance 59
	Overestimation of phase margin	vs Load capacitance 60



TYPICAL CHARACTERISTICS

DISTRIBUTION OF TLV2262  
 INPUT OFFSET VOLTAGE

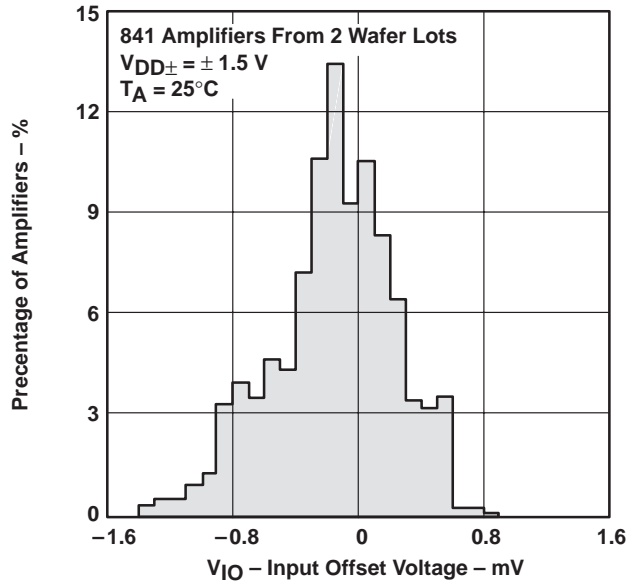

Figure 2

DISTRIBUTION OF TLV2262  
 INPUT OFFSET VOLTAGE

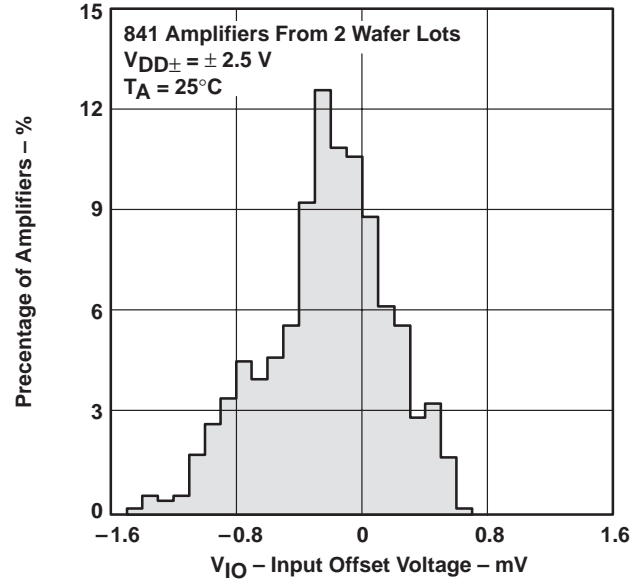

Figure 3

DISTRIBUTION OF TLV2264  
 INPUT OFFSET VOLTAGE

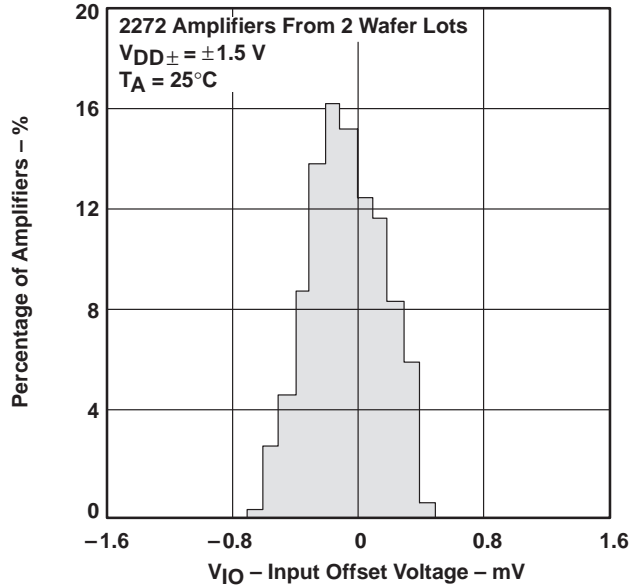

Figure 4

DISTRIBUTION OF TLV2264  
 INPUT OFFSET VOLTAGE

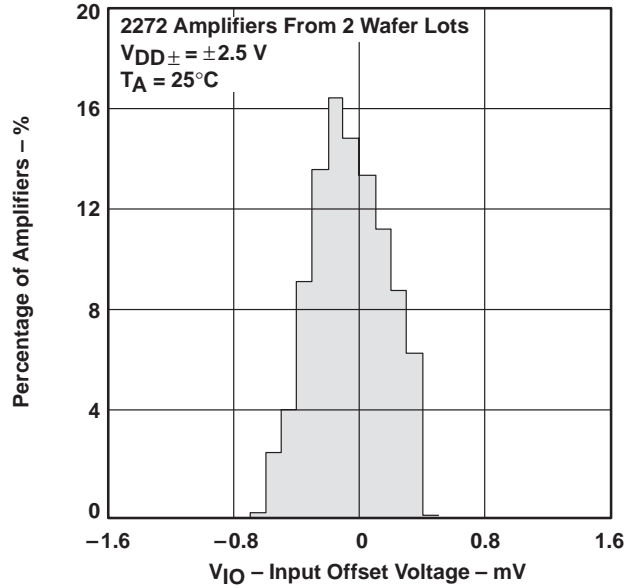

Figure 5

TYPICAL CHARACTERISTICS

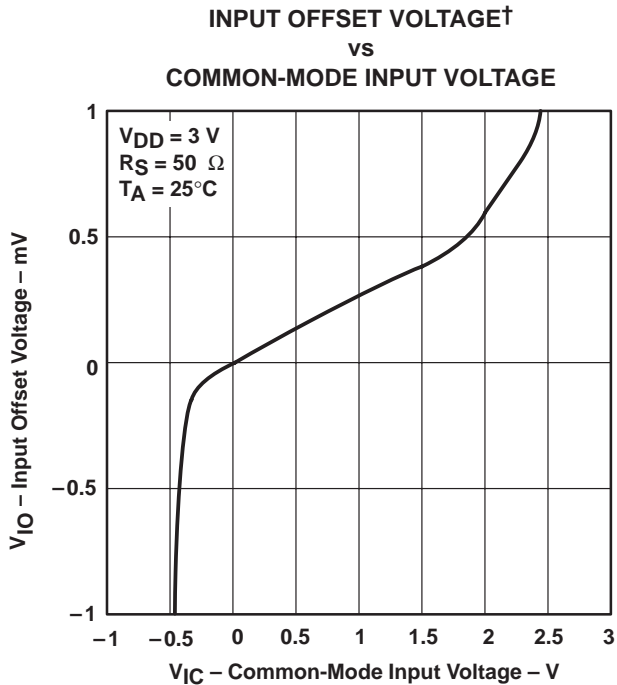

Figure 6

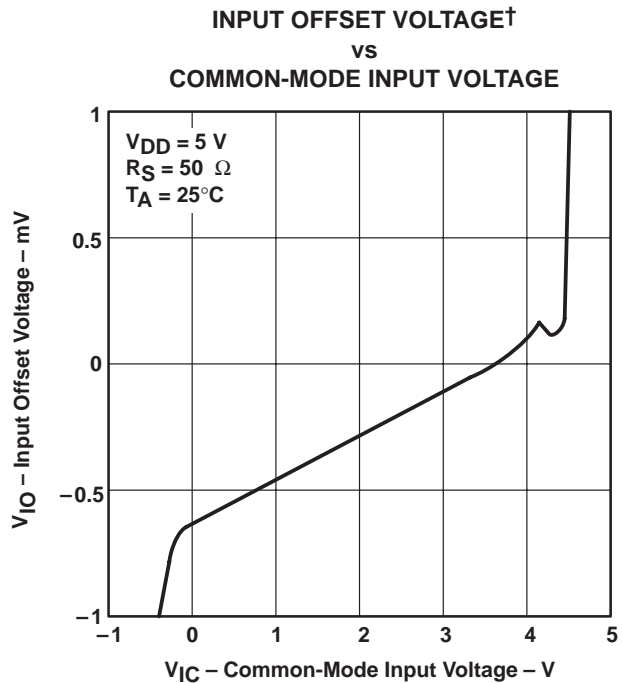

Figure 7

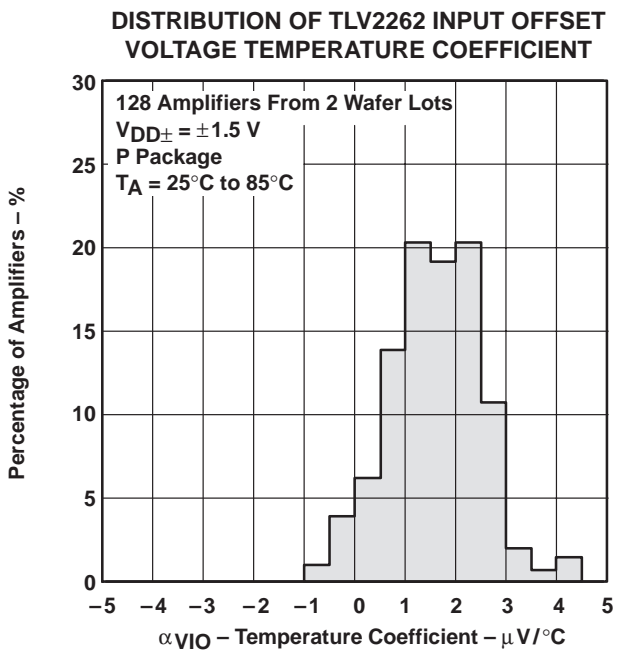

Figure 8

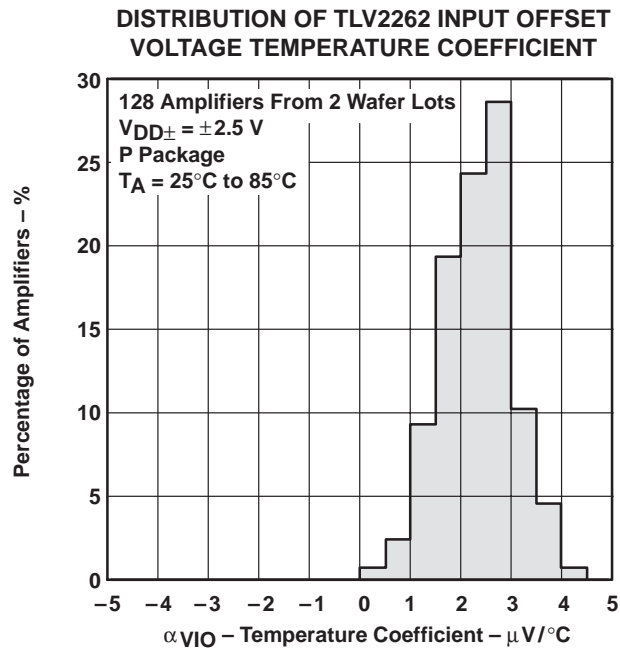

Figure 9

† For all curves where  $V_{DD} = 5\text{ V}$ , all loads are referenced to 2.5 V. For all curves where  $V_{DD} = 3\text{ V}$ , all loads are referenced to 1.5 V.



TYPICAL CHARACTERISTICS

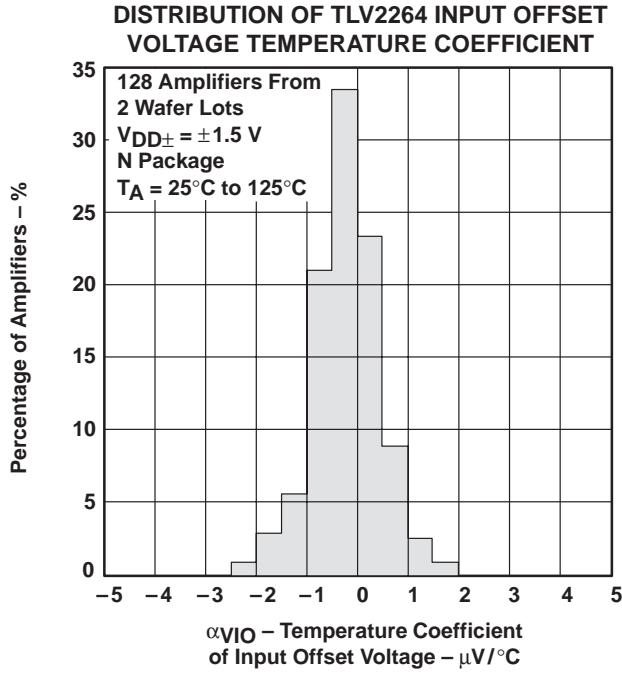

Figure 10

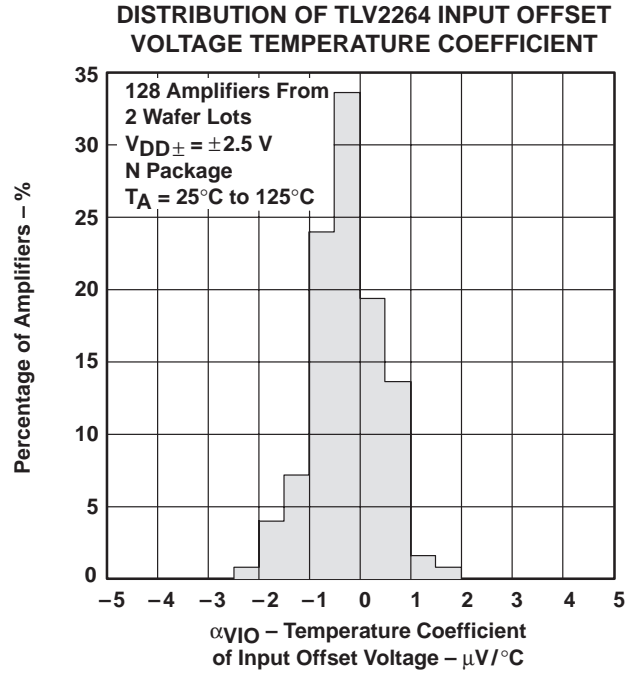

Figure 11

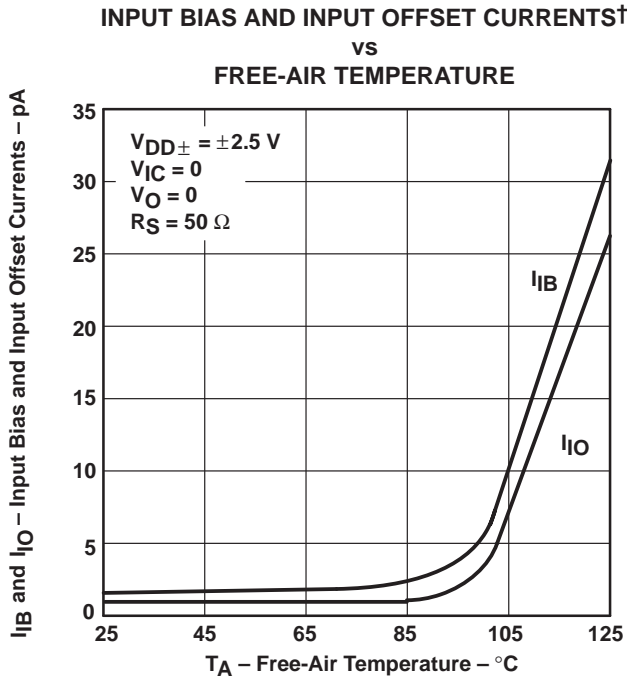

Figure 12

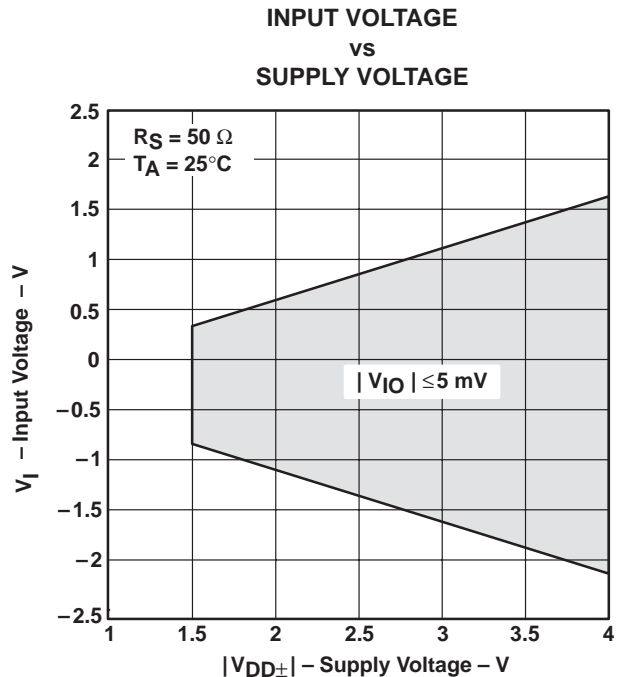

Figure 13

† Data at high and low temperatures are applicable only within the rated operating free-air temperature ranges of the various devices.

TYPICAL CHARACTERISTICS

INPUT VOLTAGE†  
 vs  
 FREE-AIR TEMPERATURE

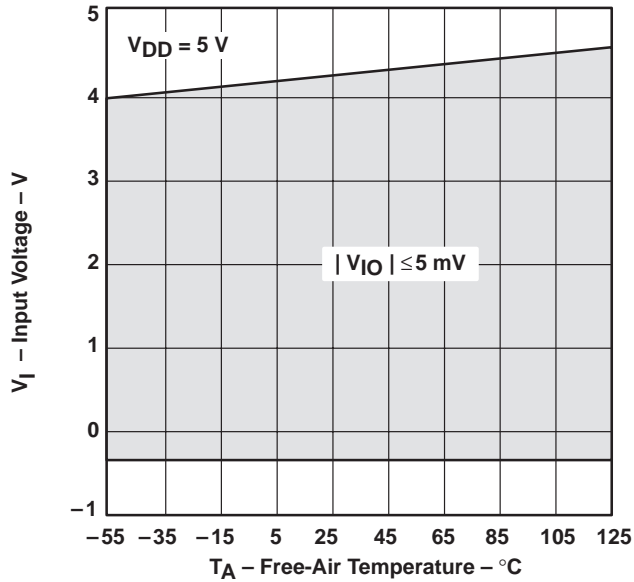

Figure 14

HIGH-LEVEL OUTPUT VOLTAGE†  
 vs  
 HIGH-LEVEL OUTPUT CURRENT

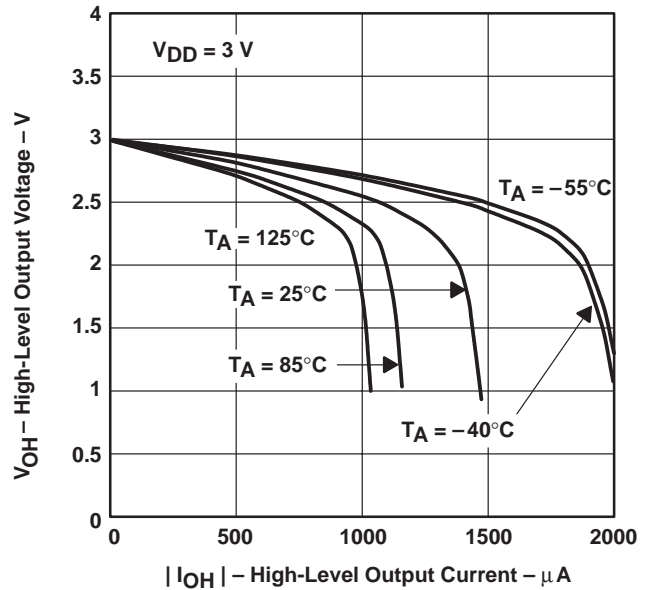

Figure 15

LOW-LEVEL OUTPUT VOLTAGE†  
 vs  
 LOW-LEVEL OUTPUT CURRENT

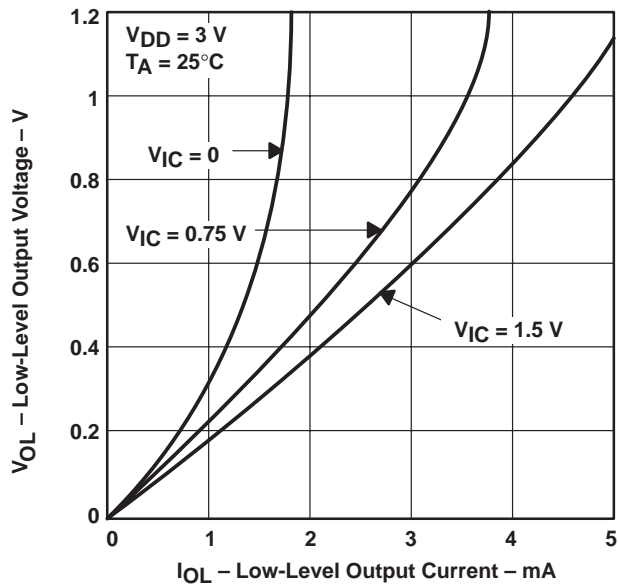

Figure 16

LOW-LEVEL OUTPUT VOLTAGE†  
 vs  
 LOW-LEVEL OUTPUT CURRENT

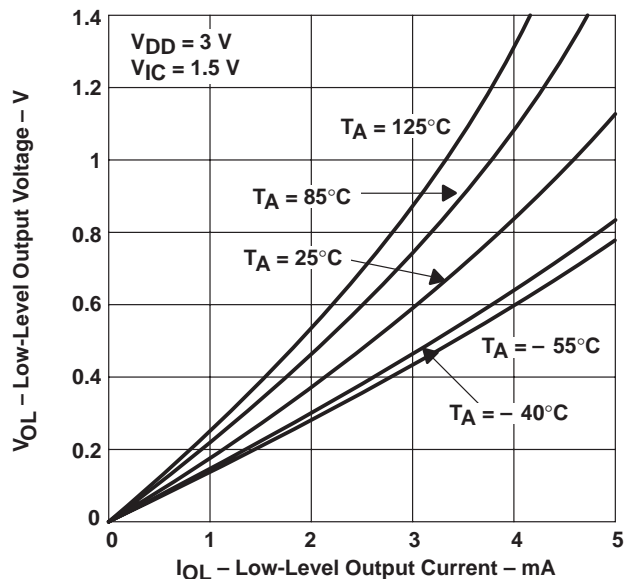

Figure 17

† Data at high and low temperatures are applicable only within the rated operating free-air temperature ranges of the various devices.  
 ‡ For all curves where  $V_{DD} = 5\text{ V}$ , all loads are referenced to  $2.5\text{ V}$ . For all curves where  $V_{DD} = 3\text{ V}$ , all loads are referenced to  $1.5\text{ V}$ .

TYPICAL CHARACTERISTICS

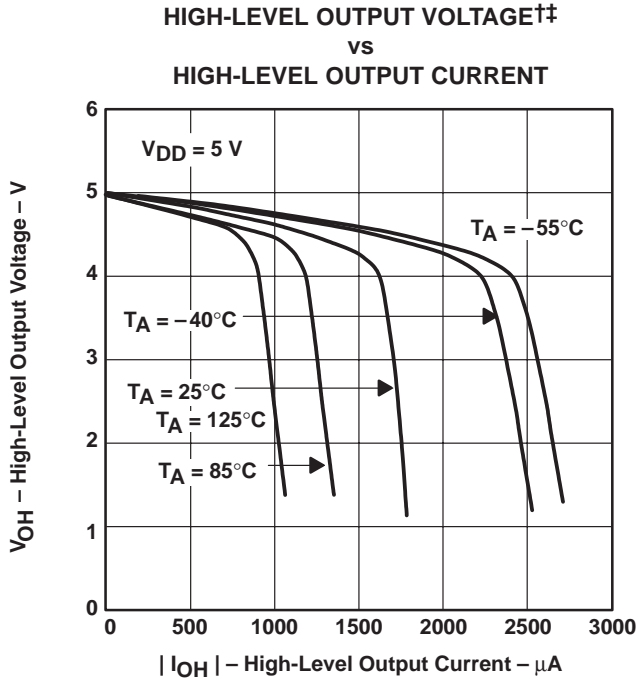

Figure 18

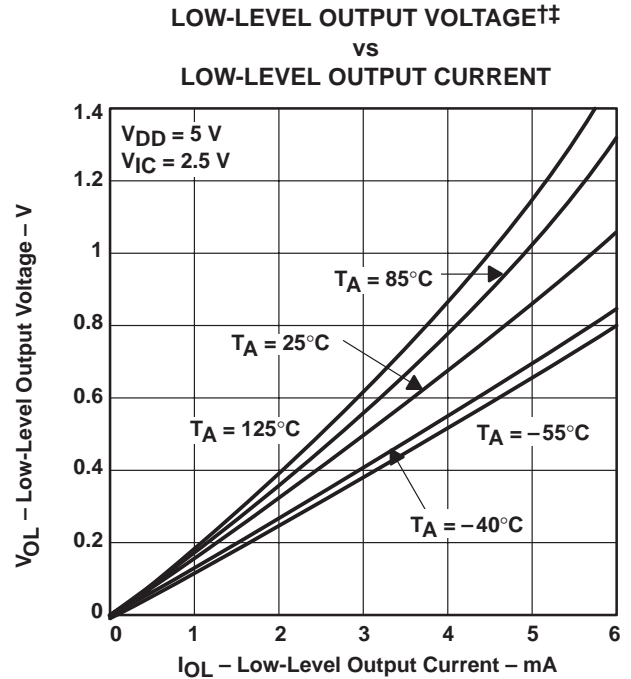

Figure 19

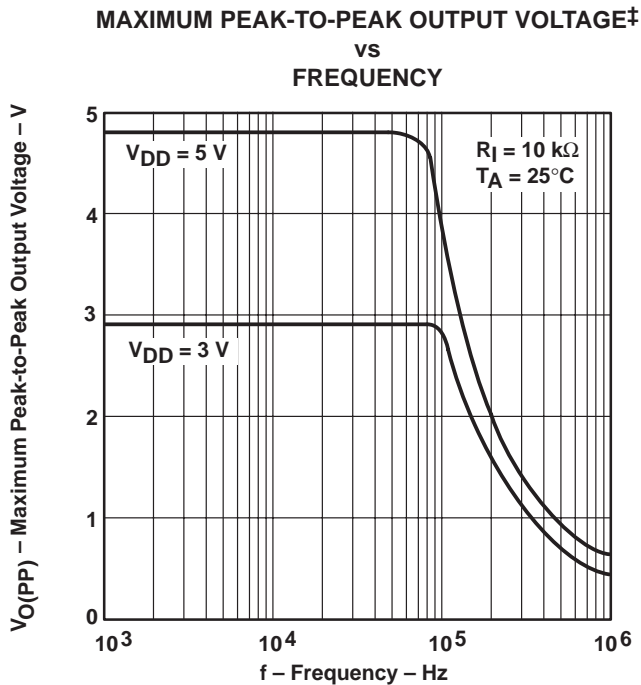

Figure 20

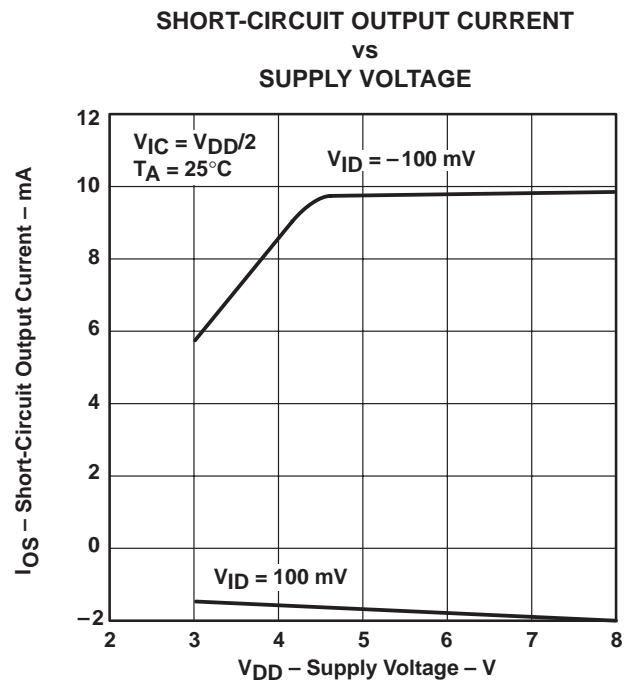

Figure 21

† Data at high and low temperatures are applicable only within the rated operating free-air temperature ranges of the various devices.  
 ‡ For all curves where  $V_{DD} = 5\text{ V}$ , all loads are referenced to 2.5 V. For all curves where  $V_{DD} = 3\text{ V}$ , all loads are referenced to 1.5 V.

TYPICAL CHARACTERISTICS

SHORT-CIRCUIT OUTPUT CURRENT†  
 vs  
 FREE-AIR TEMPERATURE

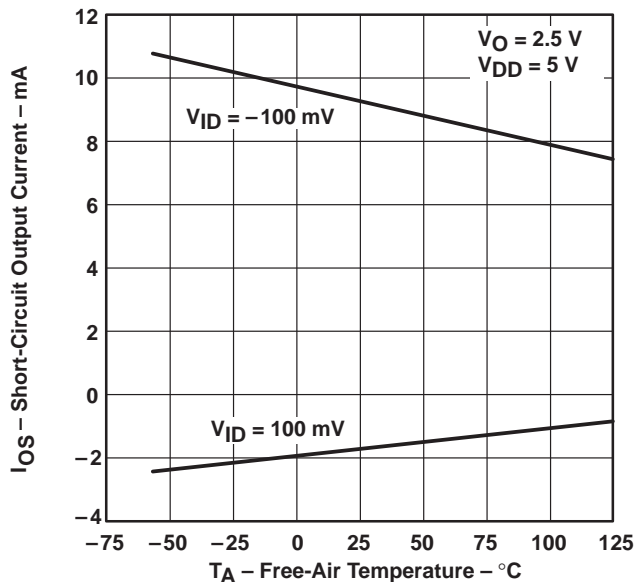

Figure 22

DIFFERENTIAL INPUT VOLTAGE‡  
 vs  
 OUTPUT VOLTAGE

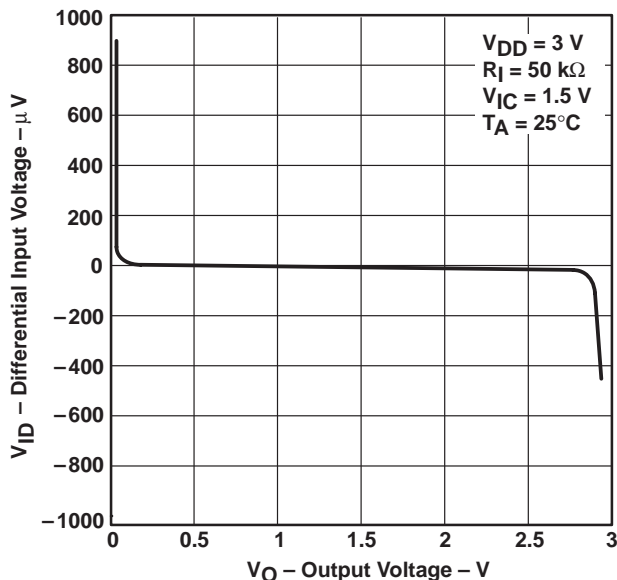

Figure 23

DIFFERENTIAL INPUT VOLTAGE‡  
 vs  
 OUTPUT VOLTAGE

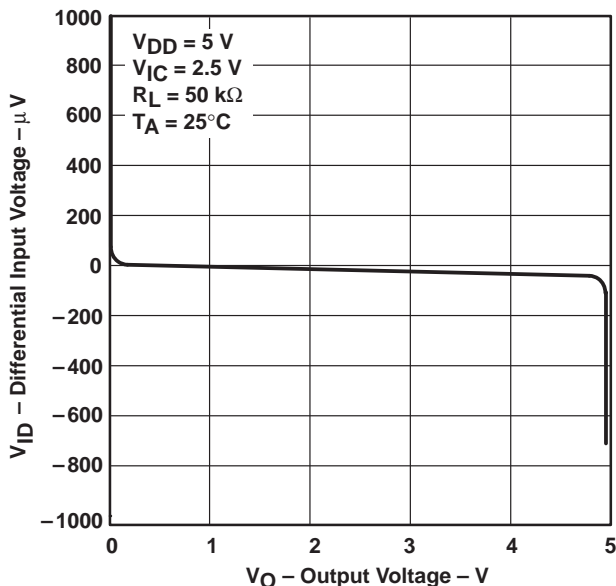

Figure 24

DIFFERENTIAL VOLTAGE AMPLIFICATION‡  
 vs  
 LOAD RESISTANCE

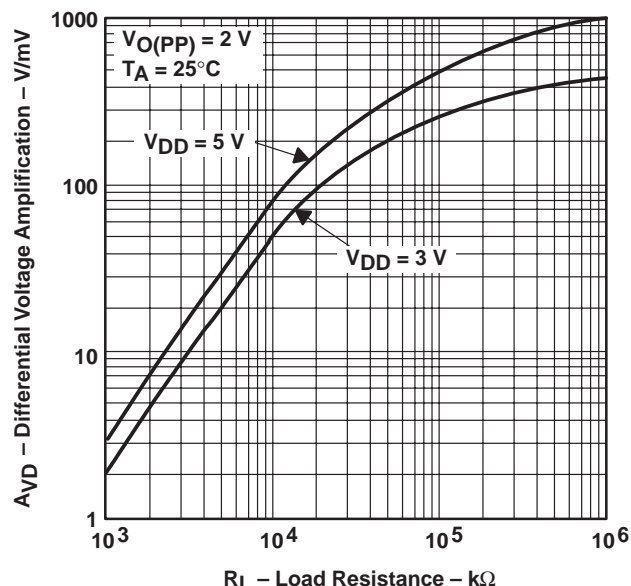

Figure 25

† Data at high and low temperatures are applicable only within the rated operating free-air temperature ranges of the various devices.

‡ For all curves where VDD = 5 V, all loads are referenced to 2.5 V. For all curves where VDD = 3 V, all loads are referenced to 1.5 V.

TYPICAL CHARACTERISTICS

LARGE-SIGNAL DIFFERENTIAL VOLTAGE  
 AMPLIFICATION AND PHASE MARGIN†  
 vs  
 FREQUENCY

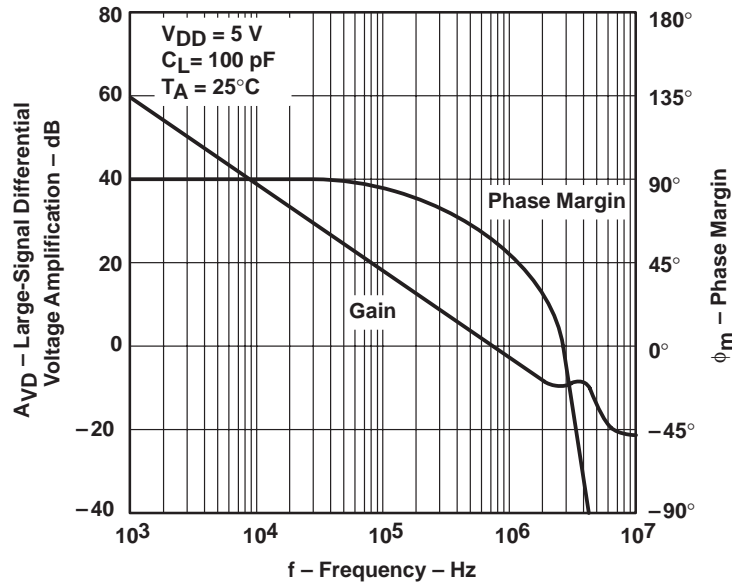

Figure 26

LARGE-SIGNAL DIFFERENTIAL VOLTAGE  
 AMPLIFICATION AND PHASE MARGIN†  
 vs  
 FREQUENCY

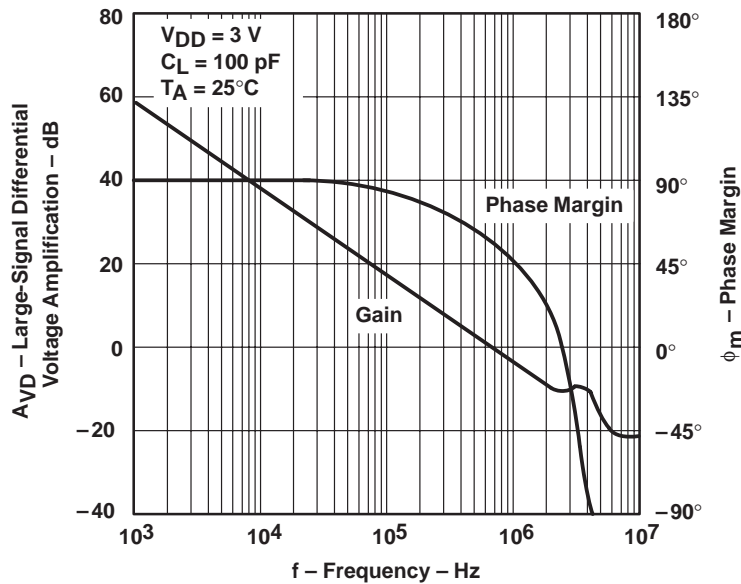

Figure 27

† For all curves where  $V_{DD} = 5\text{ V}$ , all loads are referenced to 2.5 V. For all curves where  $V_{DD} = 3\text{ V}$ , all loads are referenced to 1.5 V.

TYPICAL CHARACTERISTICS

LARGE-SIGNAL DIFFERENTIAL  
 VOLTAGE AMPLIFICATION†‡  
 vs  
 FREE-AIR TEMPERATURE

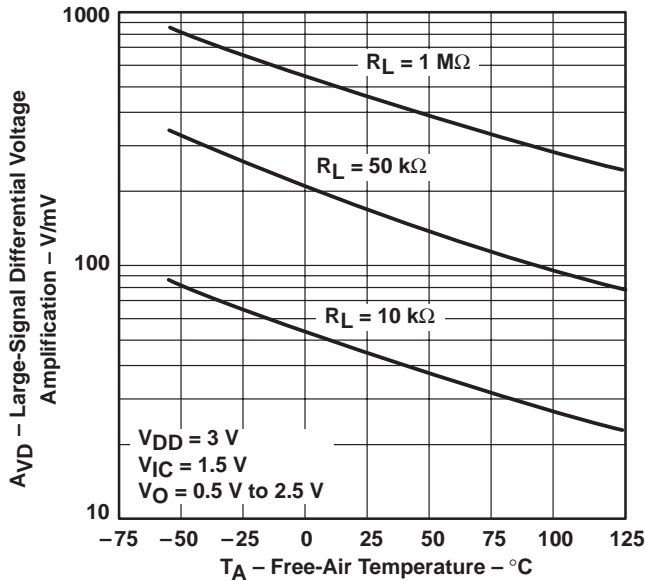

Figure 28

LARGE-SIGNAL DIFFERENTIAL  
 VOLTAGE AMPLIFICATION†‡  
 vs  
 FREE-AIR TEMPERATURE

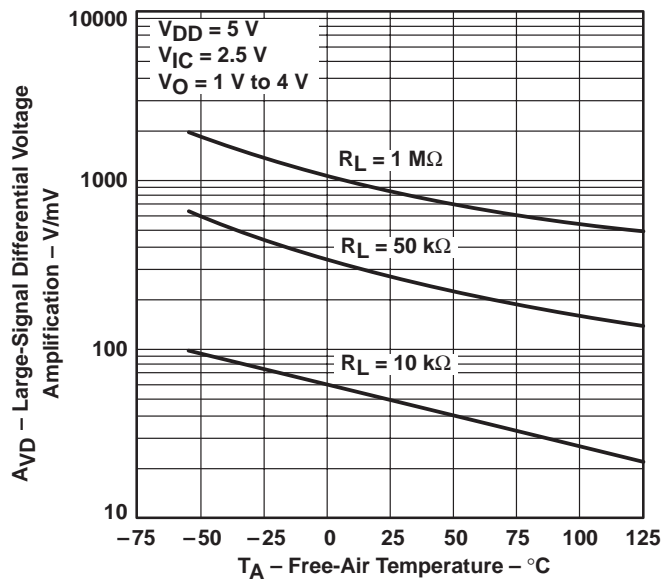

Figure 29

OUTPUT IMPEDANCE‡  
 vs  
 FREQUENCY

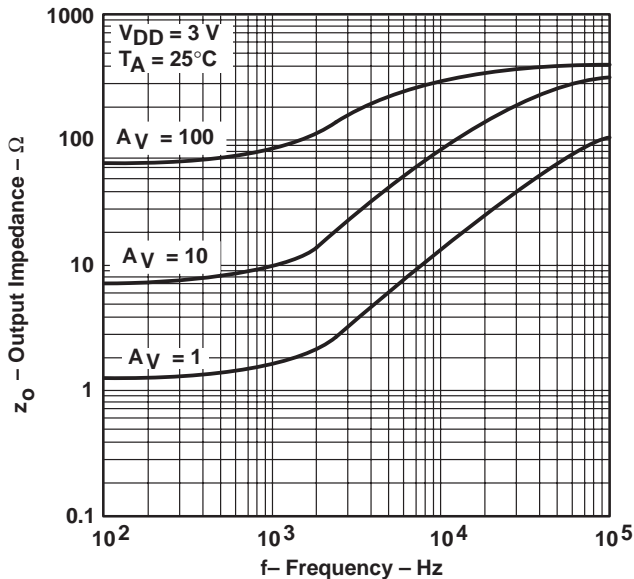

Figure 30

OUTPUT IMPEDANCE‡  
 vs  
 FREQUENCY

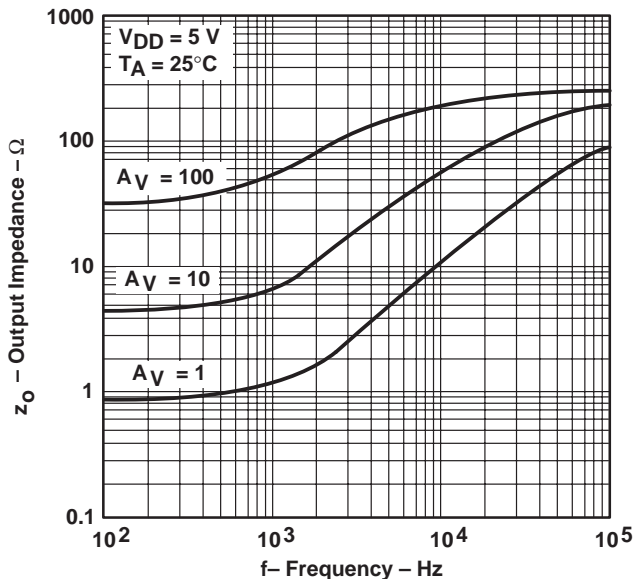

Figure 31

† Data at high and low temperatures are applicable only within the rated operating free-air temperature ranges of the various devices.

‡ For all curves where  $V_{DD} = 5\text{ V}$ , all loads are referenced to 2.5 V. For all curves where  $V_{DD} = 3\text{ V}$ , all loads are referenced to 1.5 V.

TYPICAL CHARACTERISTICS

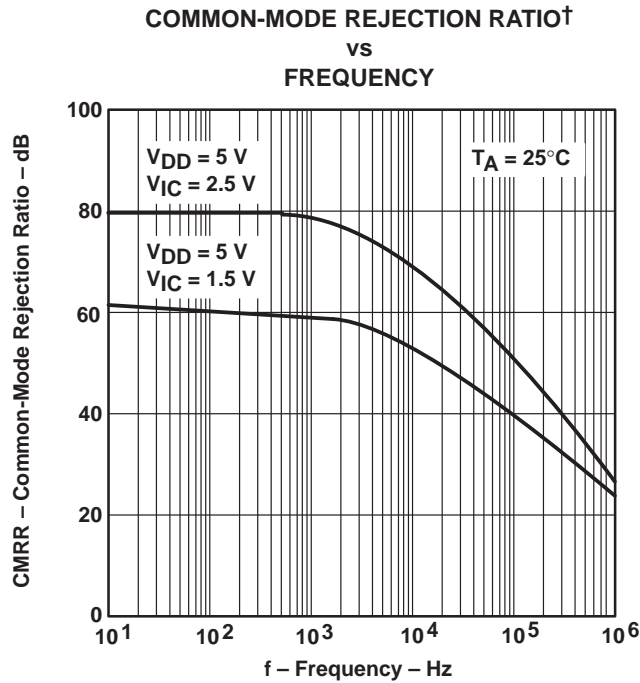

Figure 32

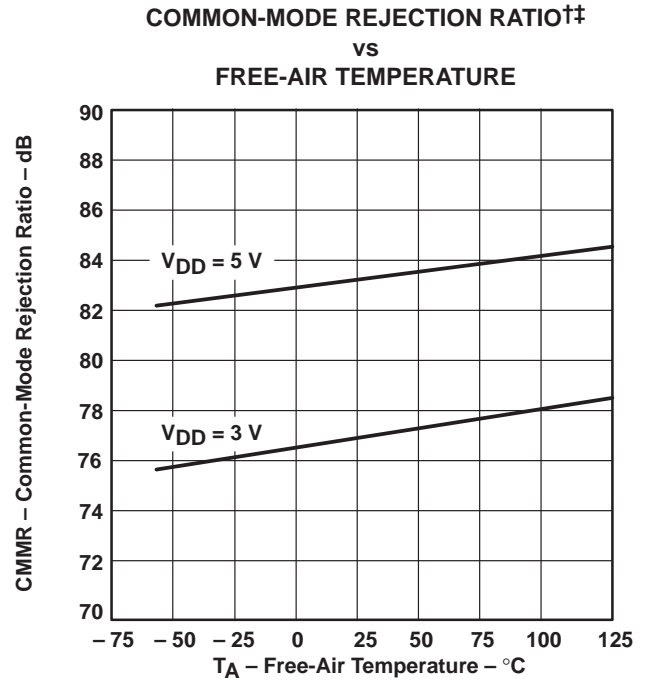

Figure 33

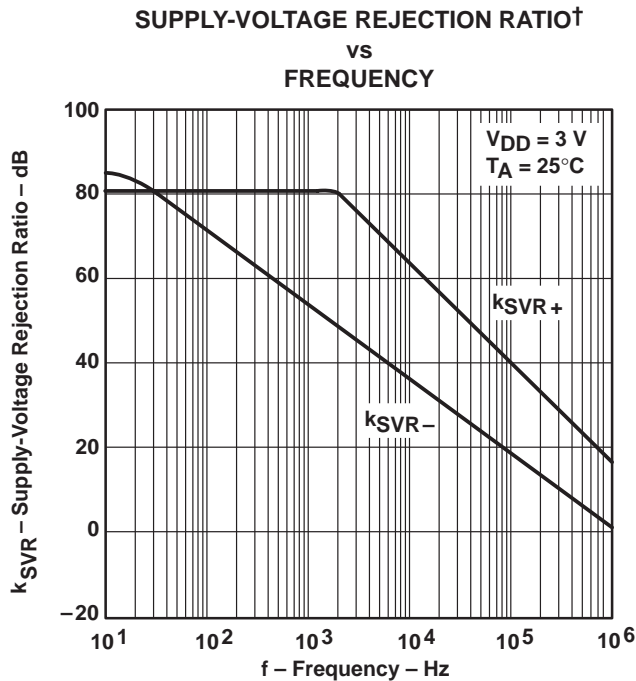

Figure 34

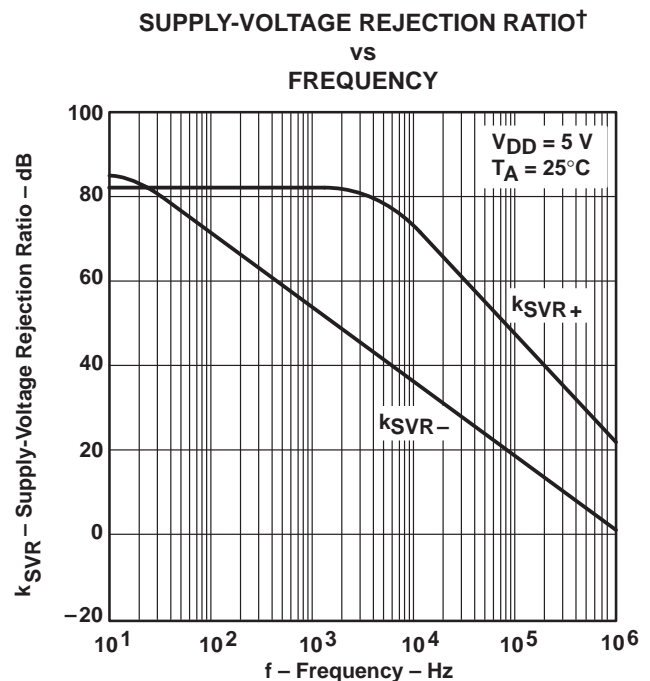

Figure 35

† For all curves where  $V_{DD} = 5\text{ V}$ , all loads are referenced to 2.5 V. For all curves where  $V_{DD} = 3\text{ V}$ , all loads are referenced to 1.5 V.  
 ‡ Data at high and low temperatures are applicable only within the rated operating free-air temperature ranges of the various devices.

TYPICAL CHARACTERISTICS

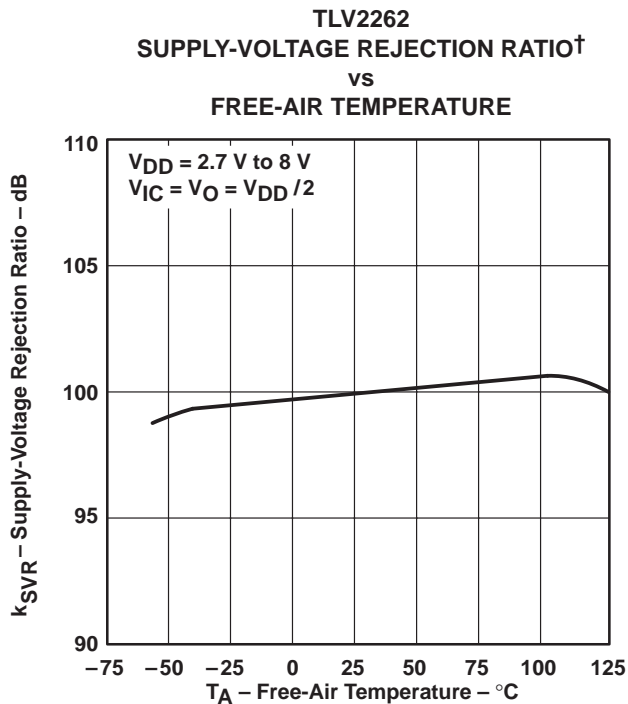

Figure 36

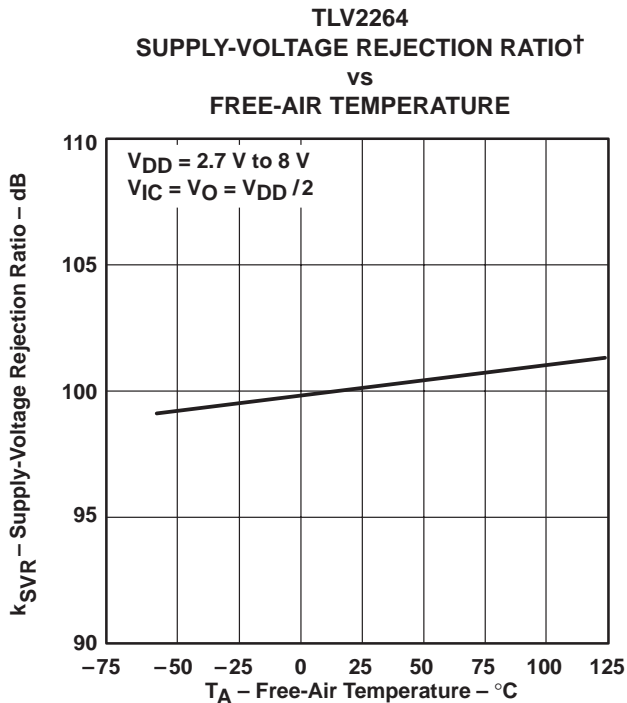

Figure 37

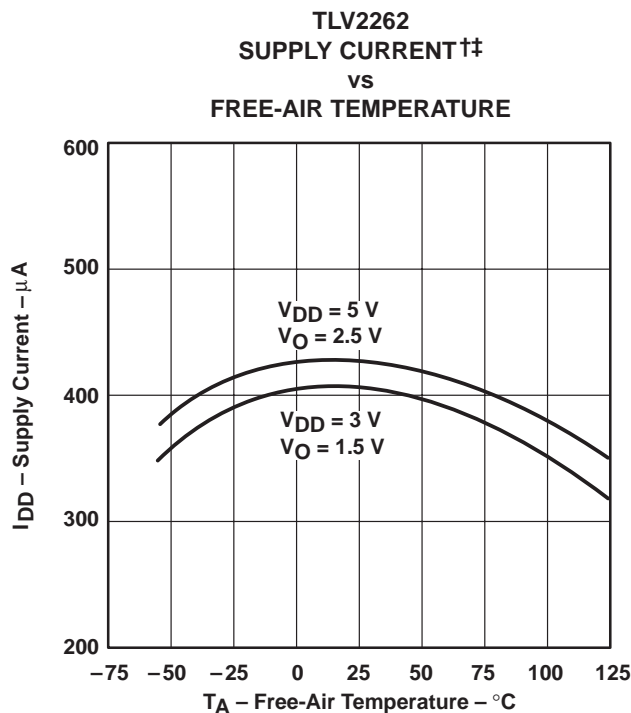

Figure 38

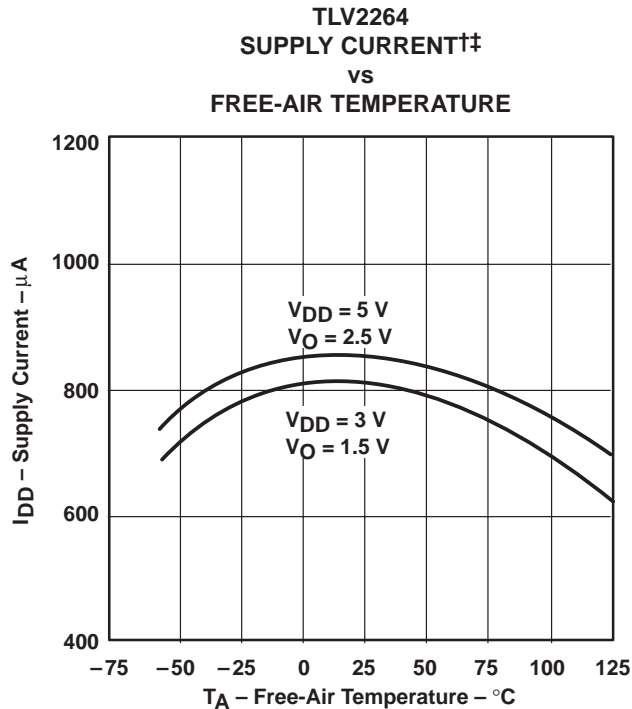

Figure 39

† Data at high and low temperatures are applicable only within the rated operating free-air temperature ranges of the various devices.

‡ For all curves where  $V_{DD} = 5 \text{ V}$ , all loads are referenced to 2.5 V. For all curves where  $V_{DD} = 3 \text{ V}$ , all loads are referenced to 1.5 V.



TYPICAL CHARACTERISTICS

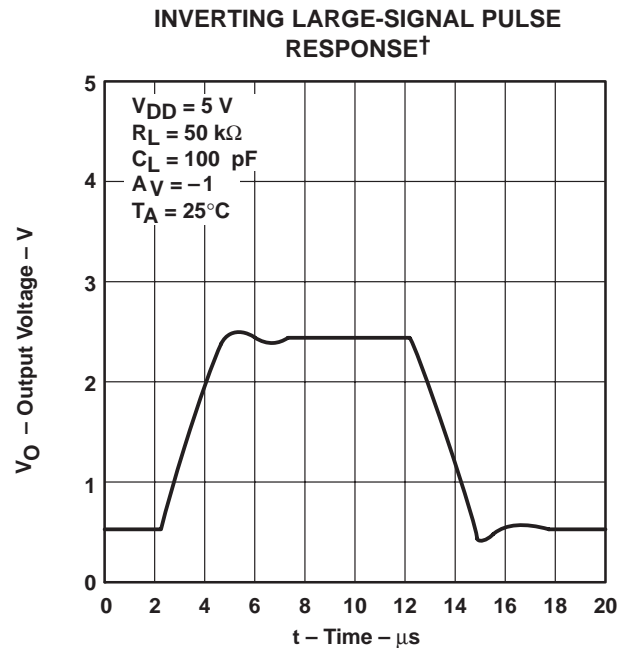
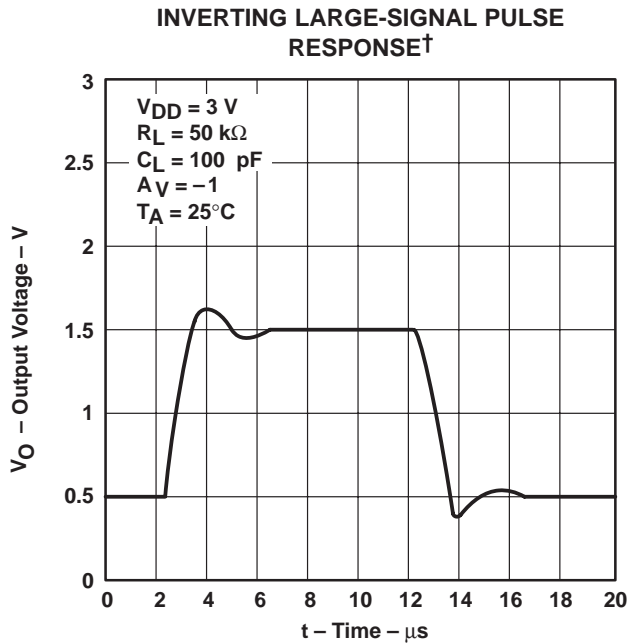
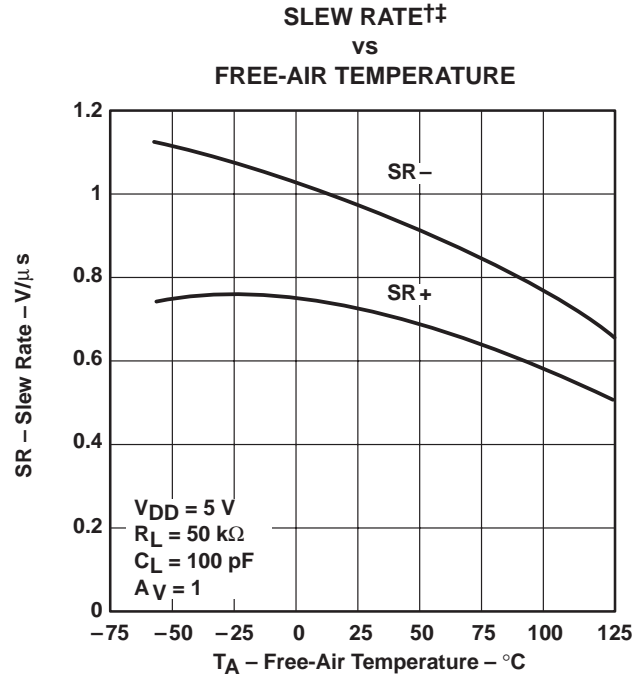
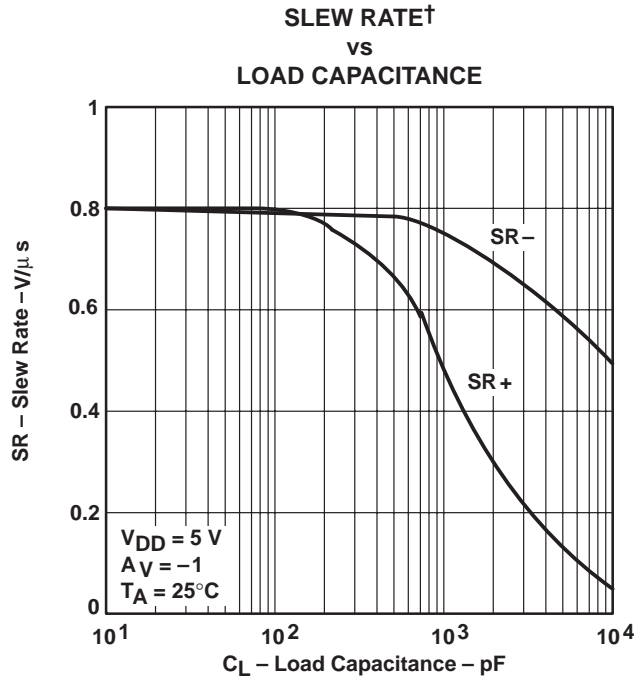

† For all curves where  $V_{DD} = 5\text{ V}$ , all loads are referenced to 2.5 V. For all curves where  $V_{DD} = 3\text{ V}$ , all loads are referenced to 1.5 V.  
 †† Data at high and low temperatures are applicable only within the rated operating free-air temperature ranges of the various devices.

TYPICAL CHARACTERISTICS

VOLTAGE-FOLLOWER LARGE-SIGNAL  
 PULSE RESPONSE†

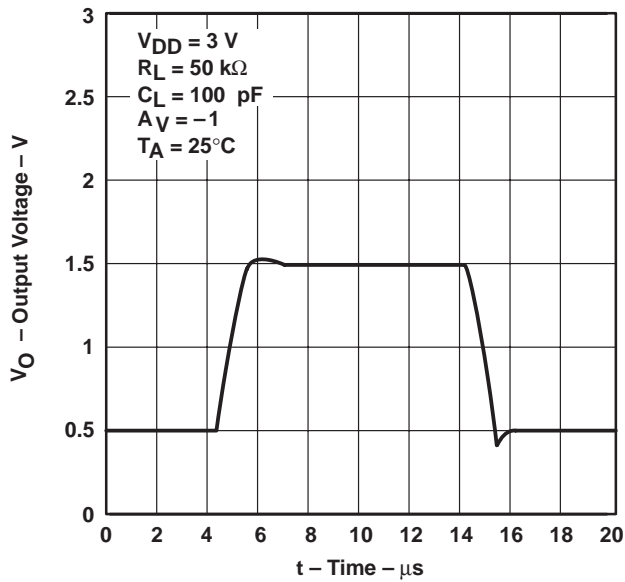

Figure 44

VOLTAGE-FOLLOWER LARGE-SIGNAL  
 PULSE RESPONSE†

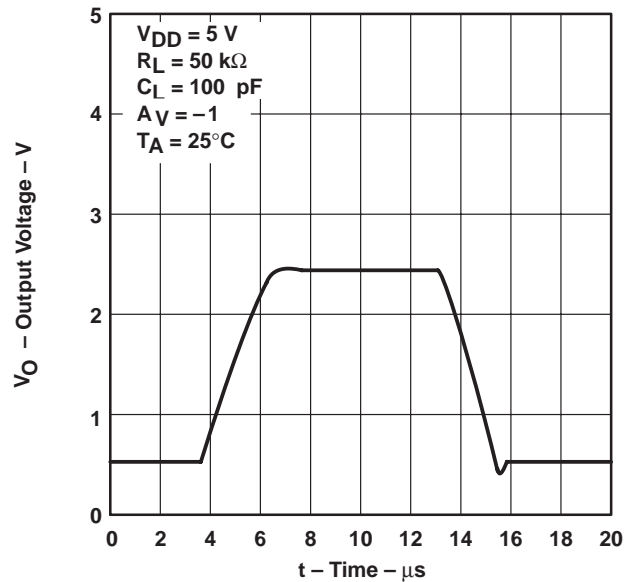

Figure 45

INVERTING SMALL-SIGNAL  
 PULSE RESPONSE†

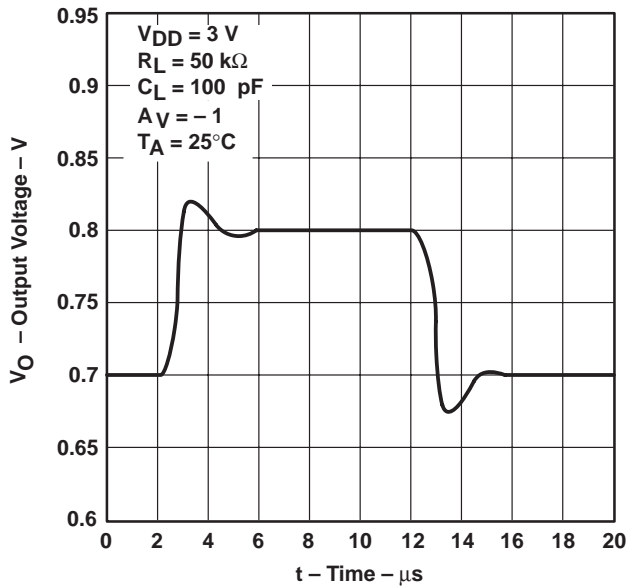

Figure 46

INVERTING SMALL-SIGNAL  
 PULSE RESPONSE†

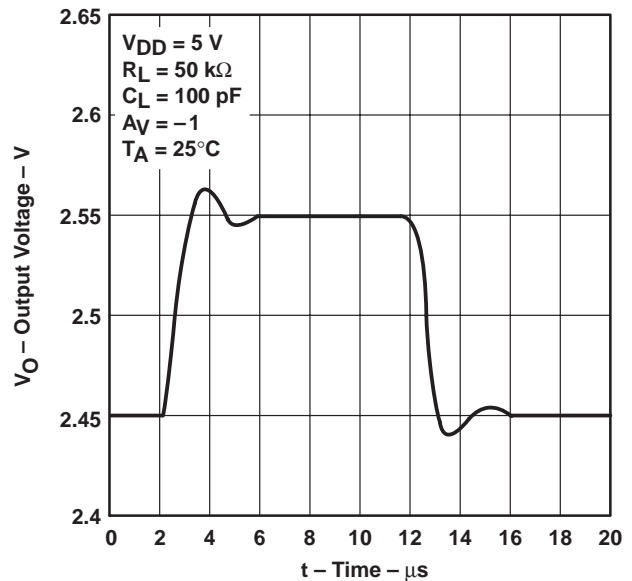

Figure 47

† For all curves where  $V_{DD} = 5\text{ V}$ , all loads are referenced to 2.5 V. For all curves where  $V_{DD} = 3\text{ V}$ , all loads are referenced to 1.5 V.

TYPICAL CHARACTERISTICS

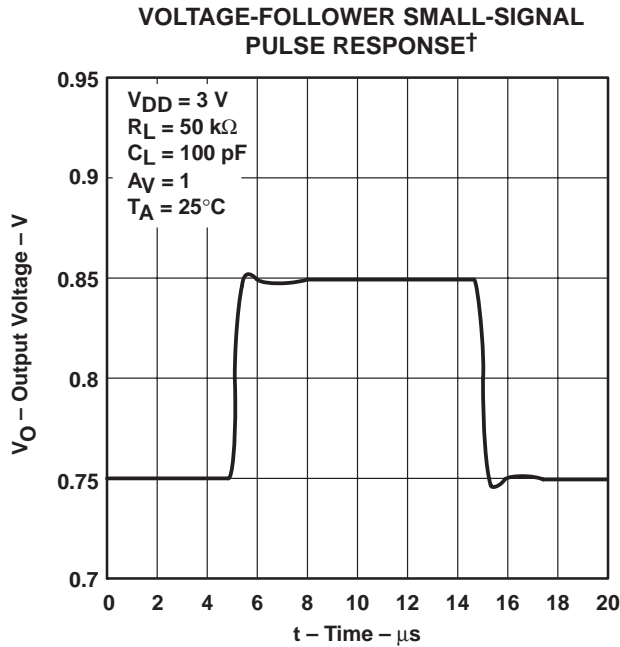

Figure 48

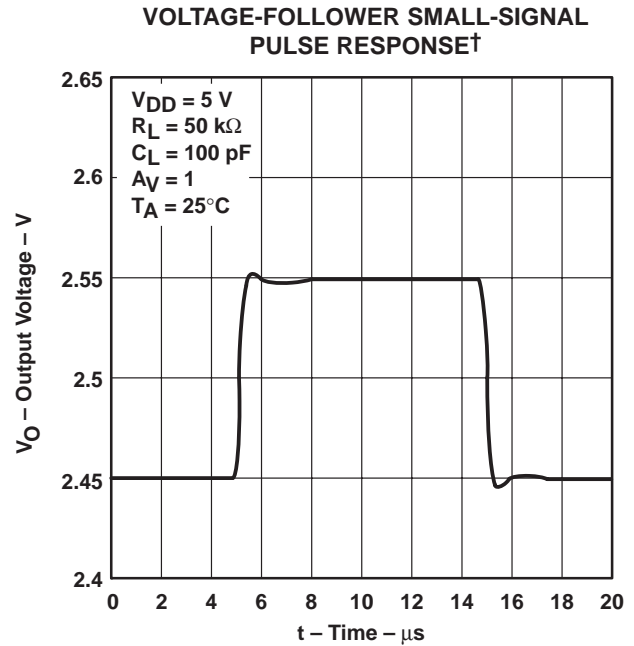

Figure 49

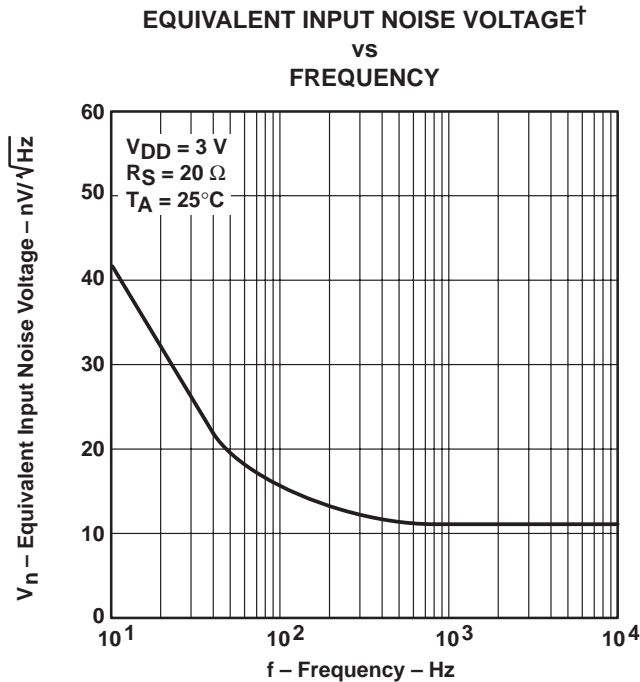

Figure 50

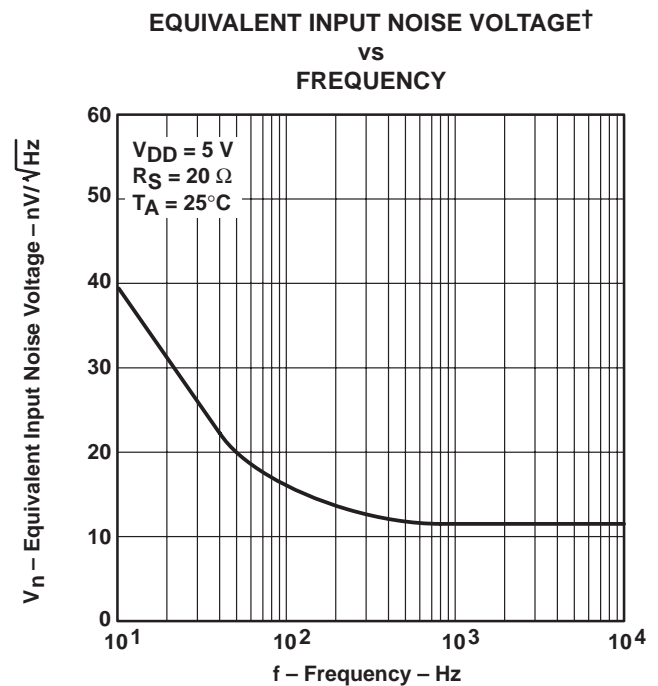

Figure 51

† For all curves where  $V_{DD} = 5\text{ V}$ , all loads are referenced to 2.5 V. For all curves where  $V_{DD} = 3\text{ V}$ , all loads are referenced to 1.5 V.

TYPICAL CHARACTERISTICS

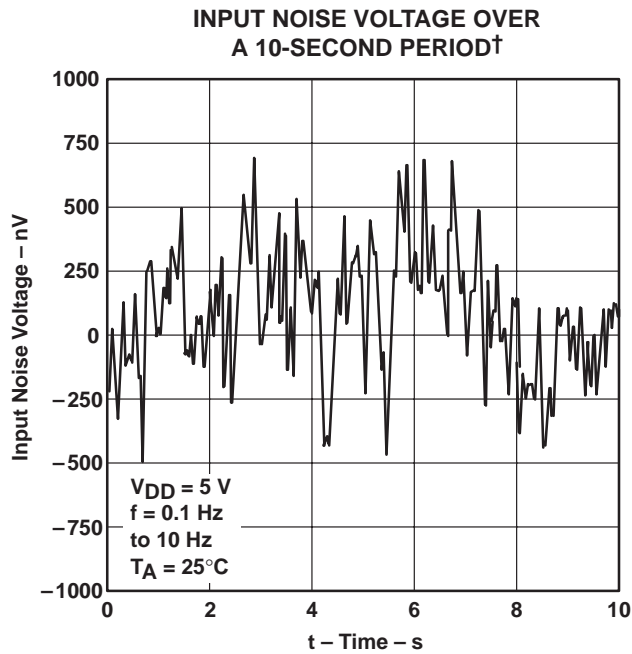

Figure 52

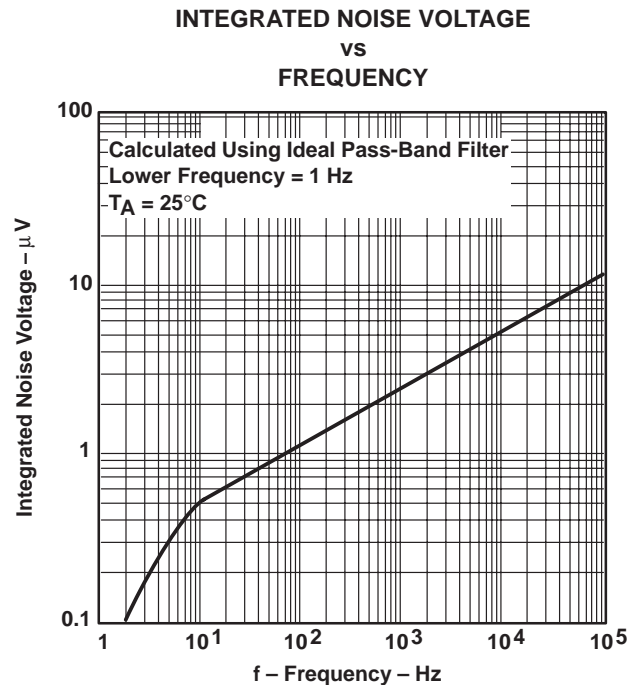

Figure 53

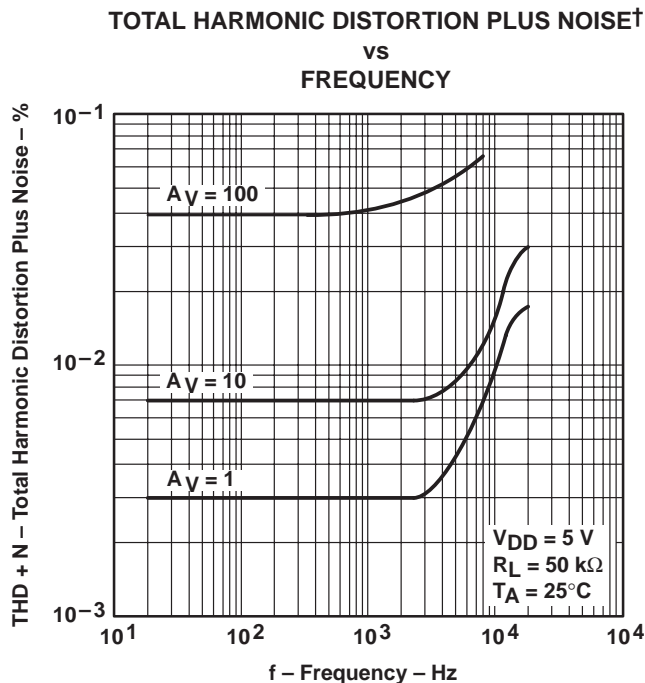

Figure 54

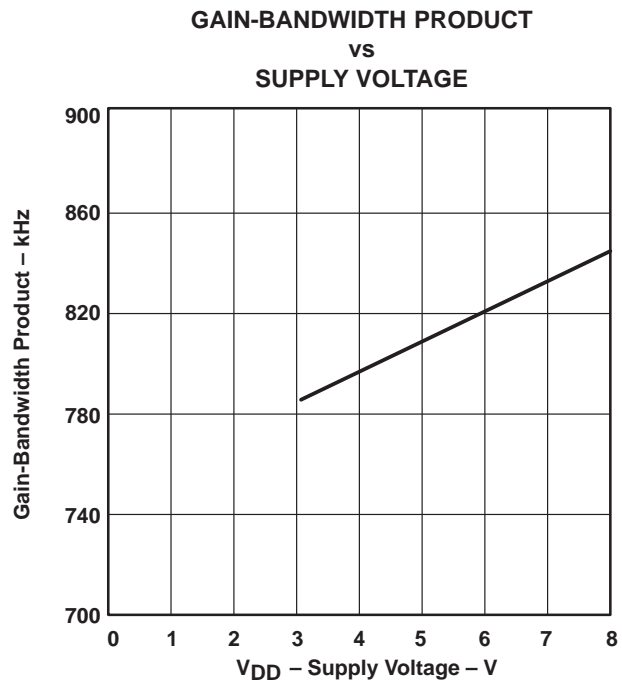

Figure 55

† For all curves where  $V_{DD} = 5\text{ V}$ , all loads are referenced to 2.5 V. For all curves where  $V_{DD} = 3\text{ V}$ , all loads are referenced to 1.5 V.

TYPICAL CHARACTERISTICS

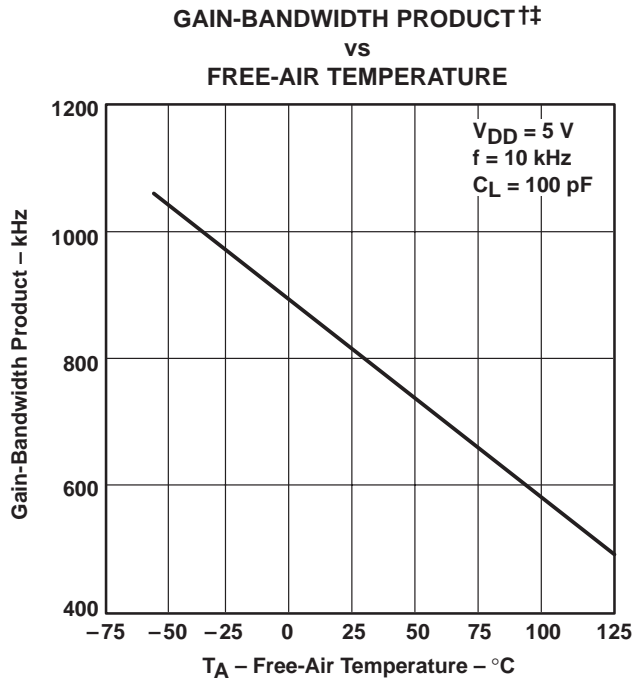

Figure 56

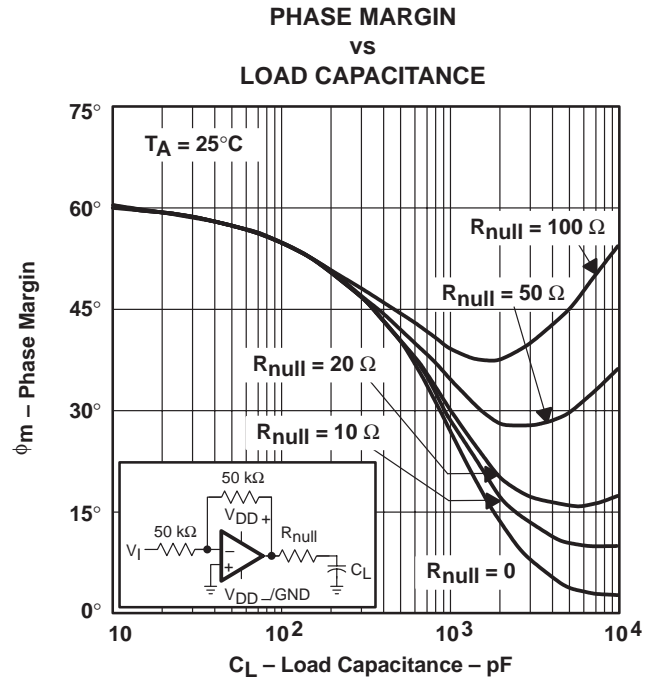

Figure 57

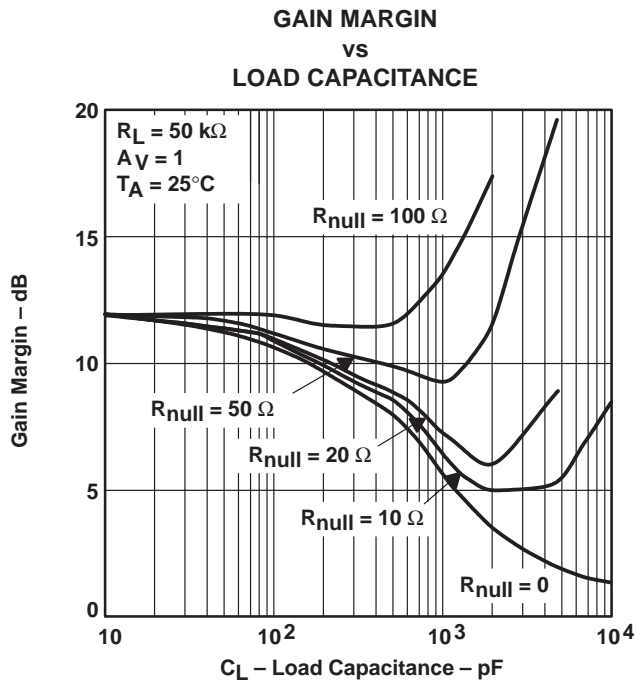

Figure 58

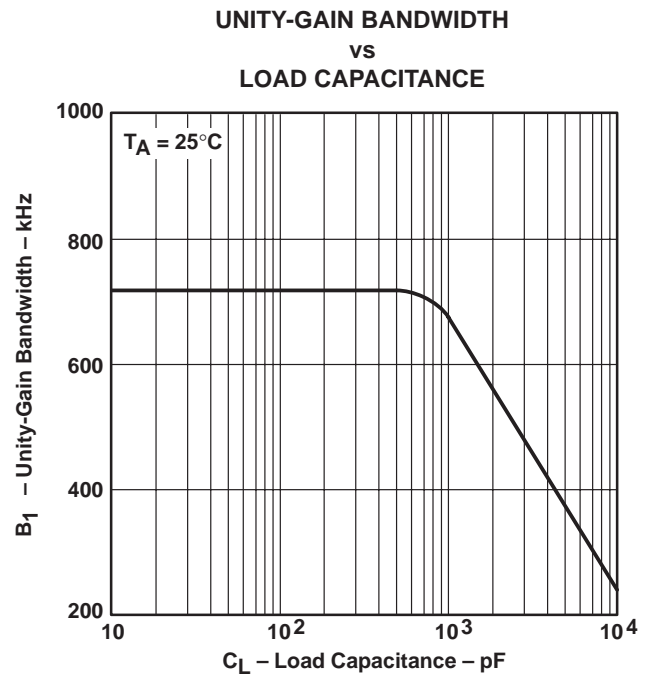
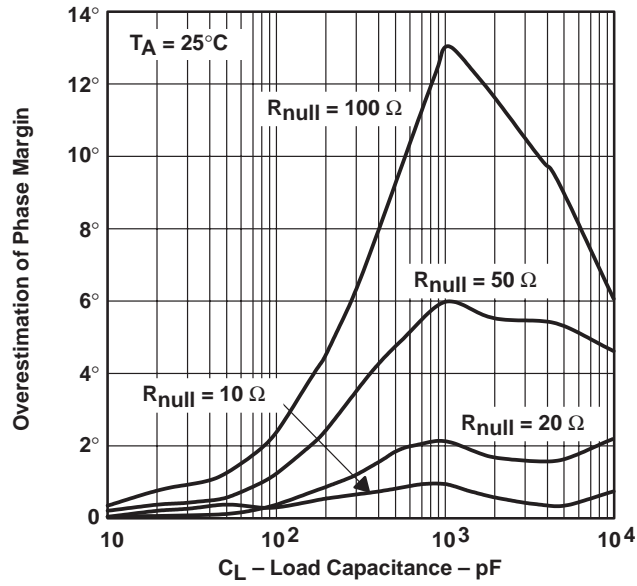

Figure 59

† For all curves where  $V_{DD} = 5\text{ V}$ , all loads are referenced to 2.5 V. For all curves where  $V_{DD} = 3\text{ V}$ , all loads are referenced to 1.5 V.  
 †† Data at high and low temperatures are applicable only within the rated operating free-air temperature ranges of the various devices.

TYPICAL CHARACTERISTICS

OVERESTIMATION OF PHASE MARGIN†  
VS  
LOAD CAPACITANCE



† See application information

Figure 60

## APPLICATION INFORMATION

### driving large capacitive loads

The TLV226x is designed to drive larger capacitive loads than most CMOS operational amplifiers. Figure 51 and Figure 52 illustrate its ability to drive loads greater than 400 pF while maintaining good gain and phase margins ( $R_{null} = 0$ ).

A smaller series resistor ( $R_{null}$ ) at the output of the device (see Figure 61) improves the gain and phase margins when driving large capacitive loads. Figure 51 and Figure 52 show the effects of adding series resistances of 10  $\Omega$ , 20  $\Omega$ , 50  $\Omega$ , and 100  $\Omega$ . The addition of this series resistor has two effects: the first is that it adds a zero to the transfer function and the second is that it reduces the frequency of the pole associated with the output load in the transfer function.

The zero introduced to the transfer function is equal to the series resistance times the load capacitance. To calculate the improvement in phase margin, equation (1) can be used.

$$\Delta\theta_{m1} = \tan^{-1} \left( 2 \times \pi \times \text{UGBW} \times R_{null} \times C_L \right) \quad (1)$$

Where :

- $\Delta\theta_{m1}$  = improvement in phase margin
- UGBW = unity-gain bandwidth frequency
- $R_{null}$  = output series resistance
- $C_L$  = load capacitance

The unity-gain bandwidth (UGBW) frequency decreases as the capacitive load increases (see Figure 53). To use equation 1, UGBW must be approximated from Figure 53.

Using equation 1 alone overestimates the improvement in phase margin as illustrated in Figure 59. The overestimation is caused by the decrease in the frequency of the pole associated with the load, providing additional phase shift and reducing the overall improvement in phase margin. The pole associated with the load is reduced by the factor calculated in equation 2.

$$F = \frac{1}{1 + g_m \times R_{null}} \quad (2)$$

Where :

- F = factor reducing frequency of pole
- $g_m$  = small-signal output transconductance (typically  $4.83 \times 10^{-3}$  mhos)
- $R_{null}$  = output series resistance

For the TLV226x, the pole associated with the load is typically 7 MHz with 100-pF load capacitance. This value varies inversely with  $C_L$ : at  $C_L = 10$  pF, use 70 MHz, at  $C_L = 1000$  pF, use 700 kHz, and so on.

Reducing the pole associated with the load introduces phase shift, thereby reducing phase margin. This results in an error in the increase in phase margin expected by considering the zero alone (equation 1). Equation 3 approximates the reduction in phase margin due to the movement of the pole associated with the load. The result of this equation can be subtracted from the result of the equation 1 to better approximate the improvement in phase margin.

**APPLICATION INFORMATION**

**driving large capacitive loads (continued)**

$$\Delta\theta_{m2} = \tan^{-1} \left[ \frac{UGBW}{(F \times P_2)} \right] - \tan^{-1} \left( \frac{UGBW}{P_2} \right) \tag{3}$$

Where :

$\Delta\theta_{m2}$  = reduction in phase margin

UGBW = unity-gain bandwidth frequency

F = factor from equation (2)

$P_2$  = unadjusted pole (70 MHz @ 10 pF, 7 MHz @ 100 pF, etc.)

Using these equations with Figure 60 and Figure 61 enables the designer to choose the appropriate output series resistance to optimize the design of circuits driving large capacitive loads.

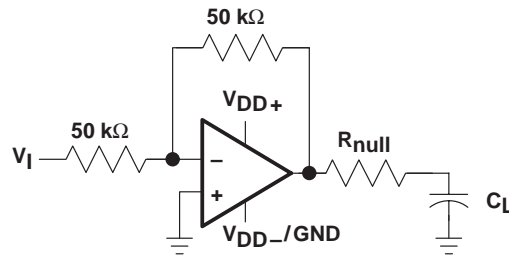

**Figure 61. Series-Resistance Circuit**



## APPLICATION INFORMATION

### macromodel information

Macromodel information provided was derived using Microsim *Parts*™, the model generation software used with Microsim *PSpice*™. The Boyle macromodel (see Note 5) and subcircuit in Figure 62 are generated using the TLV226x typical electrical and operating characteristics at  $T_A = 25^\circ\text{C}$ . Using this information, output simulations of the following key parameters can be generated to a tolerance of 20% (in most cases):

- Maximum positive output voltage swing
- Maximum negative output voltage swing
- Slew rate
- Quiescent power dissipation
- Input bias current
- Open-loop voltage amplification
- Unity-gain frequency
- Common-mode rejection ratio
- Phase margin
- DC output resistance
- AC output resistance
- Short-circuit output current limit

NOTE 5: G. R. Boyle, B. M. Cohn, D. O. Pederson, and J. E. Solomon, "Macromodeling of Integrated Circuit Operational Amplifiers," *IEEE Journal of Solid-State Circuits*, SC-9, 353 (1974).

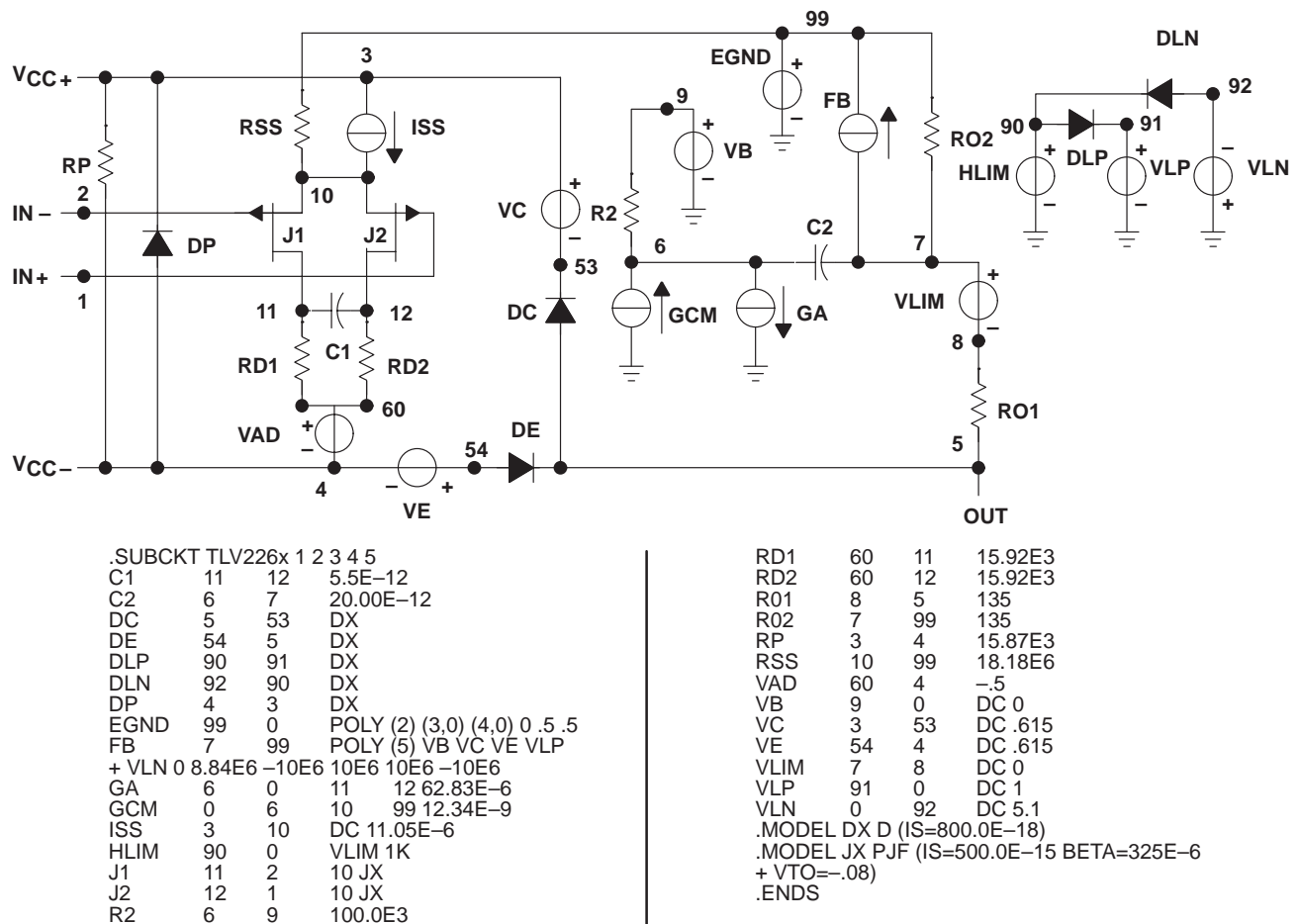

Figure 62. Boyle Macromodel and Subcircuit

*PSpice* and *Parts* are trademarks of MicroSim Corporation.

**TLV226x, TLV226xA**  
**Advanced LinCMOS™ RAIL-TO-RAIL**  
**OPERATIONAL AMPLIFIERS**

SLOS186A – FEBRUARY 1997 – REVISED JULY 1999

**MECHANICAL INFORMATION**

**D (R-PDSO-G\*\*)**

**PLASTIC SMALL-OUTLINE PACKAGE**

14 PIN SHOWN

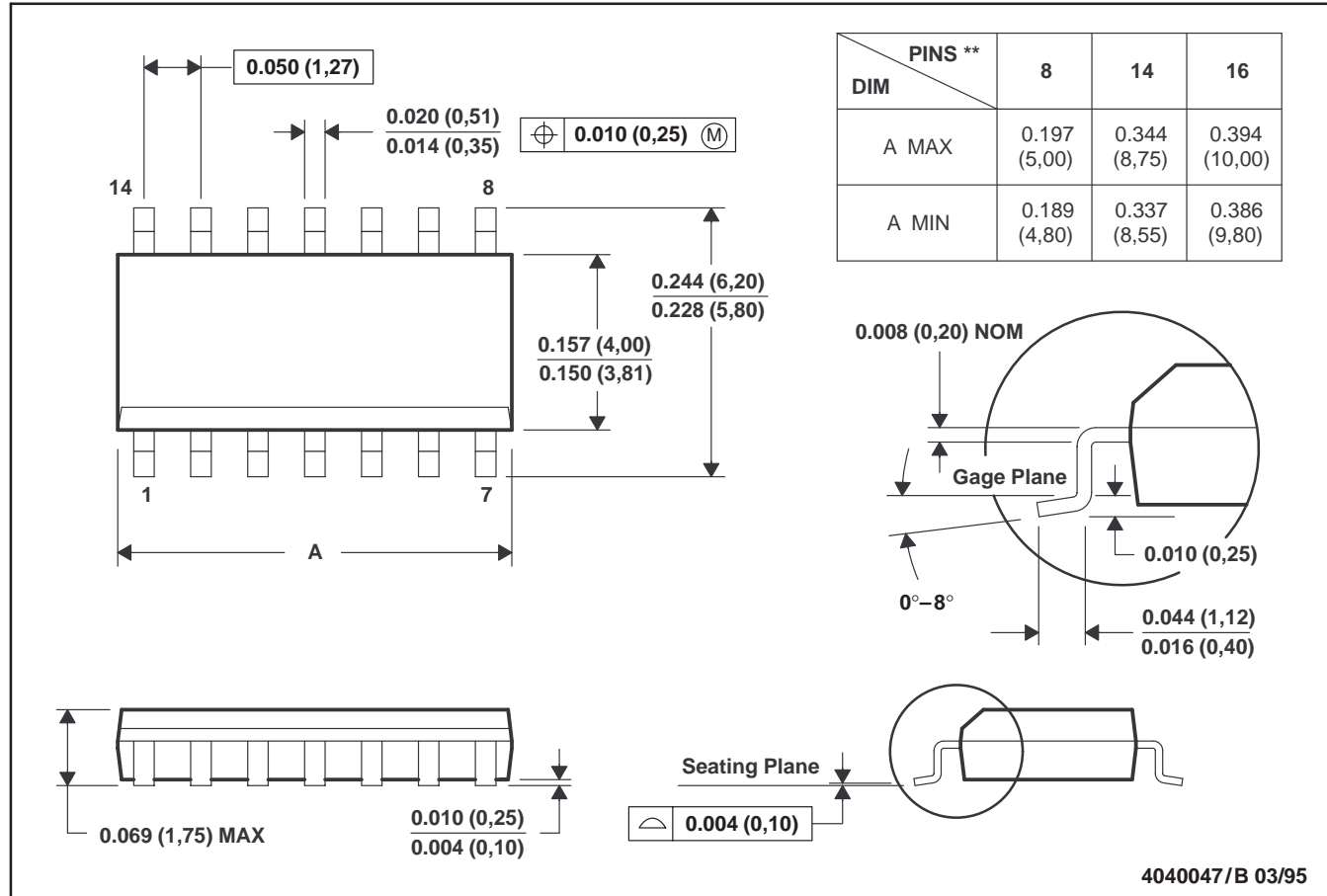

- NOTES: A. All linear dimensions are in inches (millimeters).  
 B. This drawing is subject to change without notice.  
 C. Body dimensions do not include mold flash or protrusion, not to exceed 0.006 (0,15).  
 D. Four center pins are connected to die mount pad.  
 E. Falls within JEDEC MS-012

MECHANICAL INFORMATION

FK (S-CQCC-N\*\*)

LEADLESS CERAMIC CHIP CARRIER

28 TERMINAL SHOWN

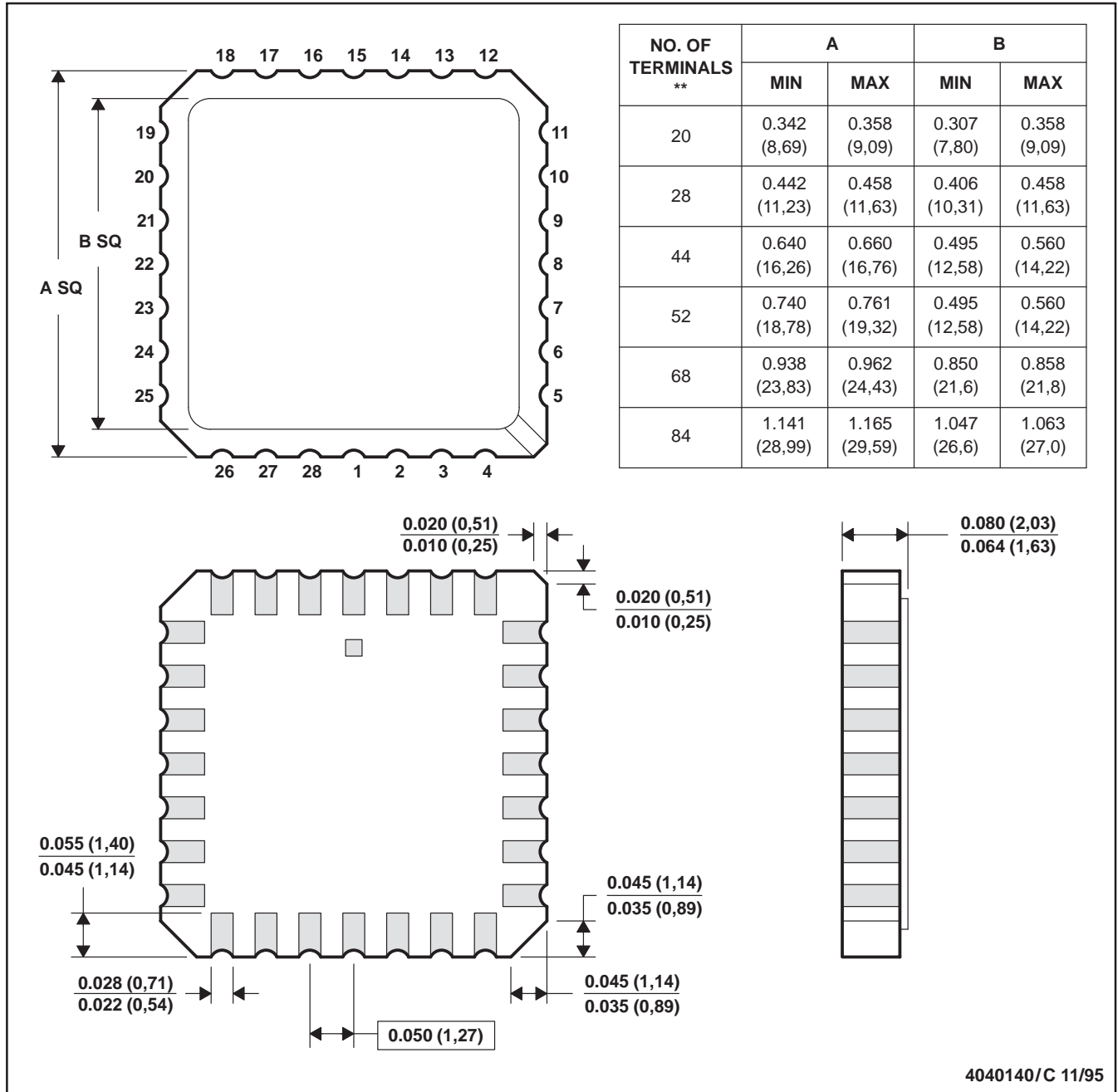

- NOTES: A. All linear dimensions are in inches (millimeters).  
 B. This drawing is subject to change without notice.  
 C. This package can be hermetically sealed with a metal lid.  
 D. The terminals are gold plated.  
 E. Falls within JEDEC MS-004

**TLV226x, TLV226xA**  
**Advanced LinCMOS™ RAIL-TO-RAIL**  
**OPERATIONAL AMPLIFIERS**

SLOS186A – FEBRUARY 1997 – REVISED JULY 1999

**MECHANICAL INFORMATION**

**J (R-GDIP-T\*\*)**

**CERAMIC DUAL-IN-LINE PACKAGE**

14 PIN SHOWN

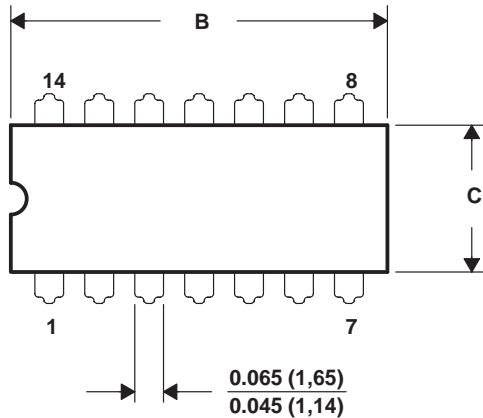

DIM	PINS **				
	14	16	18	20	22
A MAX	0.310 (7,87)	0.310 (7,87)	0.310 (7,87)	0.310 (7,87)	0.410 (10,41)
A MIN	0.290 (7,37)	0.290 (7,37)	0.290 (7,37)	0.290 (7,37)	0.390 (9,91)
B MAX	0.785 (19,94)	0.785 (19,94)	0.910 (23,10)	0.975 (24,77)	1.100 (28,00)
B MIN	0.755 (19,18)	0.755 (19,18)	—	0.930 (23,62)	—
C MAX	0.280 (7,11)	0.300 (7,62)	0.300 (7,62)	0.300 (7,62)	0.388 (9,65)
C MIN	0.245 (6,22)	0.245 (6,22)	0.245 (6,22)	0.245 (6,22)	—

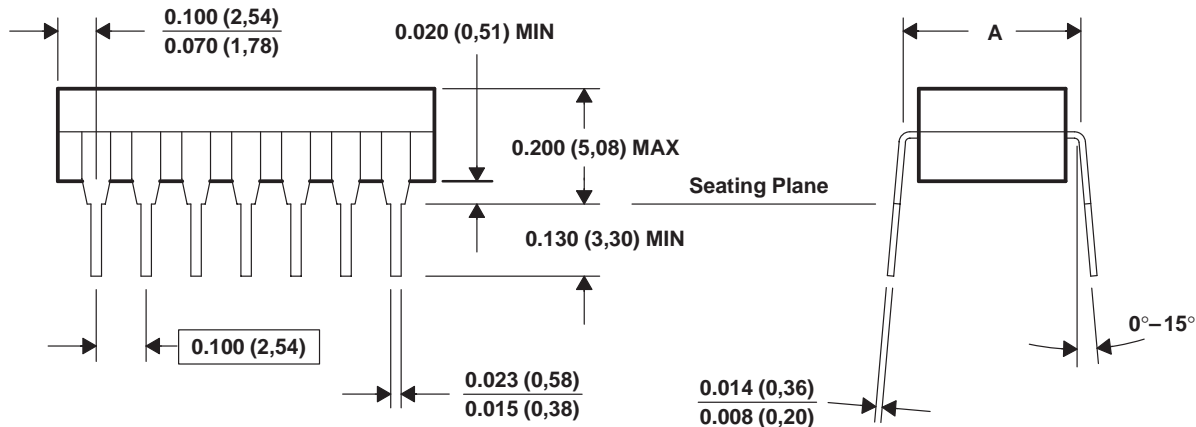

4040083/B 04/95

- NOTES: A. All linear dimensions are in inches (millimeters).  
 B. This drawing is subject to change without notice.  
 C. This package can be hermetically sealed with a ceramic lid using glass frit.  
 D. Index point is provided on cap for terminal identification only on press ceramic glass frit seal only.  
 E. Falls within MIL-STD-1835 GDIP1-T14, GDIP1-T16, GDIP1-T18, GDIP1-T20, and GDIP1-T22



POST OFFICE BOX 655303 • DALLAS, TEXAS 75265

MECHANICAL INFORMATION

JG (R-GDIP-T8)

CERAMIC DUAL-IN-LINE PACKAGE

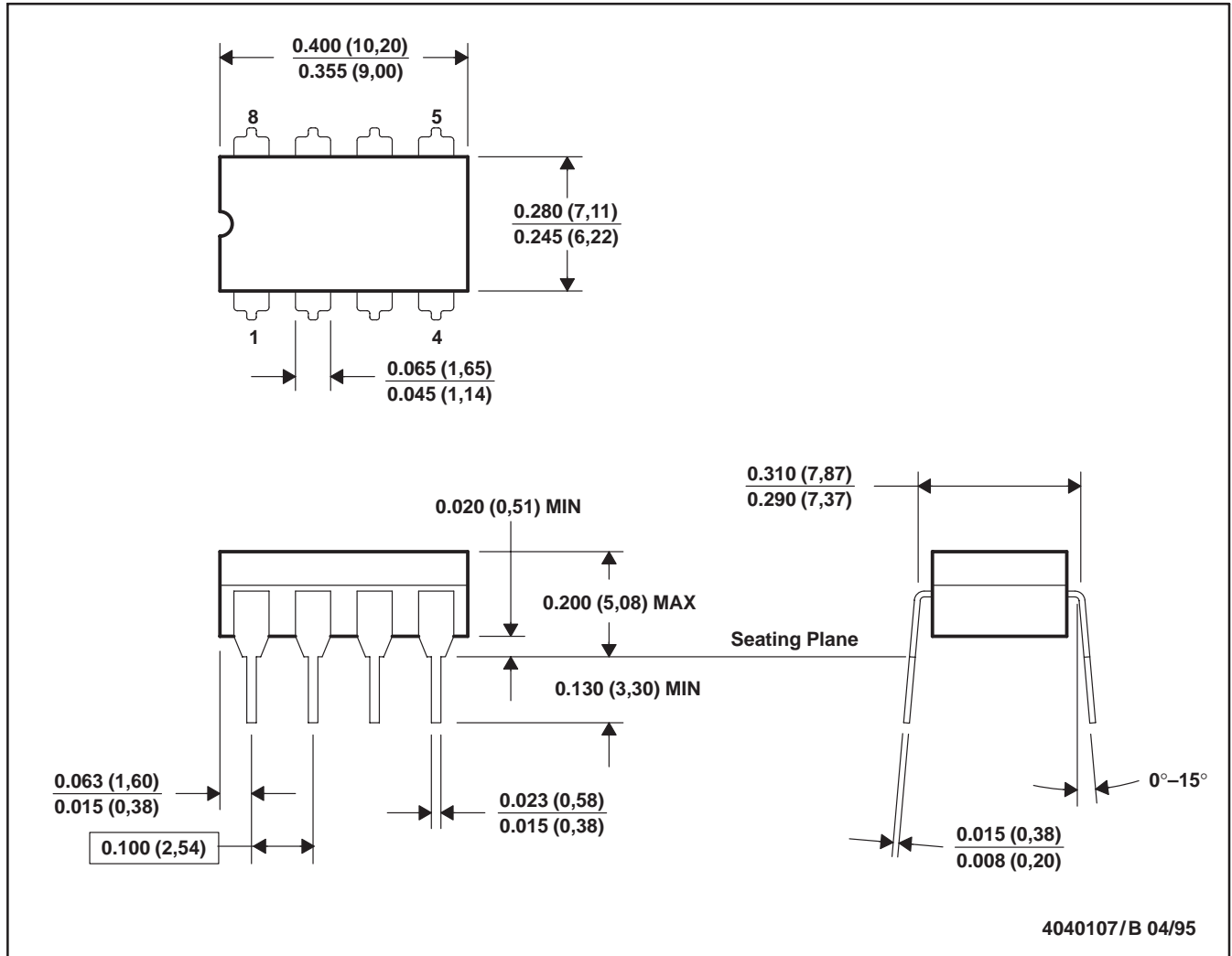

- NOTES: A. All linear dimensions are in inches (millimeters).  
 B. This drawing is subject to change without notice.  
 C. This package can be hermetically sealed with a ceramic lid using glass frit.  
 D. Index point is provided on cap for terminal identification only on press ceramic glass frit seal only  
 E. Falls within MIL-STD-1835 GDIP1-T8

**TLV226x, TLV226xA**  
**Advanced LinCMOS™ RAIL-TO-RAIL**  
**OPERATIONAL AMPLIFIERS**

SLOS186A – FEBRUARY 1997 – REVISED JULY 1999

**MECHANICAL INFORMATION**

**N (R-PDIP-T\*\*)**

**PLASTIC DUAL-IN-LINE PACKAGE**

16 PIN SHOWN

DIM \ PINS **	14	16	18	20
A MAX	0.775 (19,69)	0.775 (19,69)	0.920 (23,37)	0.975 (24,77)
A MIN	0.745 (18,92)	0.745 (18,92)	0.850 (21,59)	0.940 (23,88)

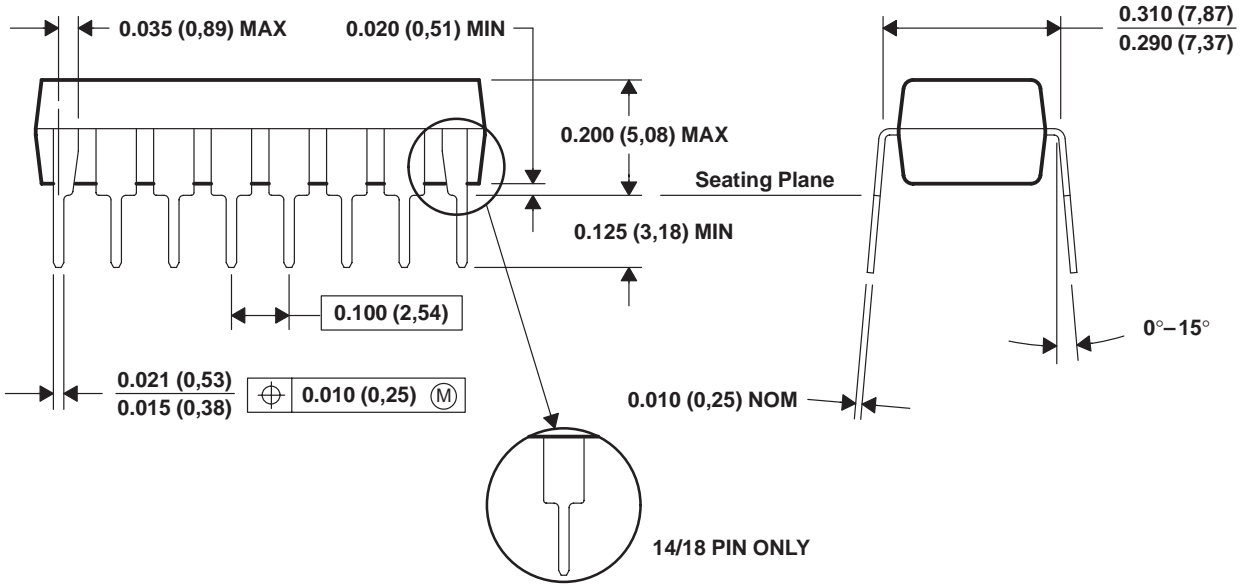
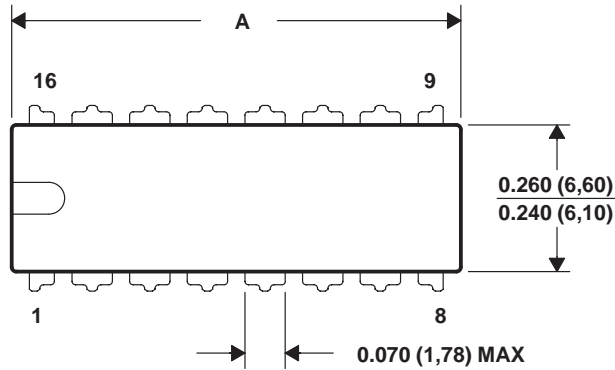

4040049/C 08/95

- NOTES: A. All linear dimensions are in inches (millimeters).  
 B. This drawing is subject to change without notice.  
 C. Falls within JEDEC MS-001 (20 pin package is shorter than MS-001.)



POST OFFICE BOX 655303 • DALLAS, TEXAS 75265

MECHANICAL INFORMATION

P (R-PDIP-T8)

PLASTIC DUAL-IN-LINE PACKAGE

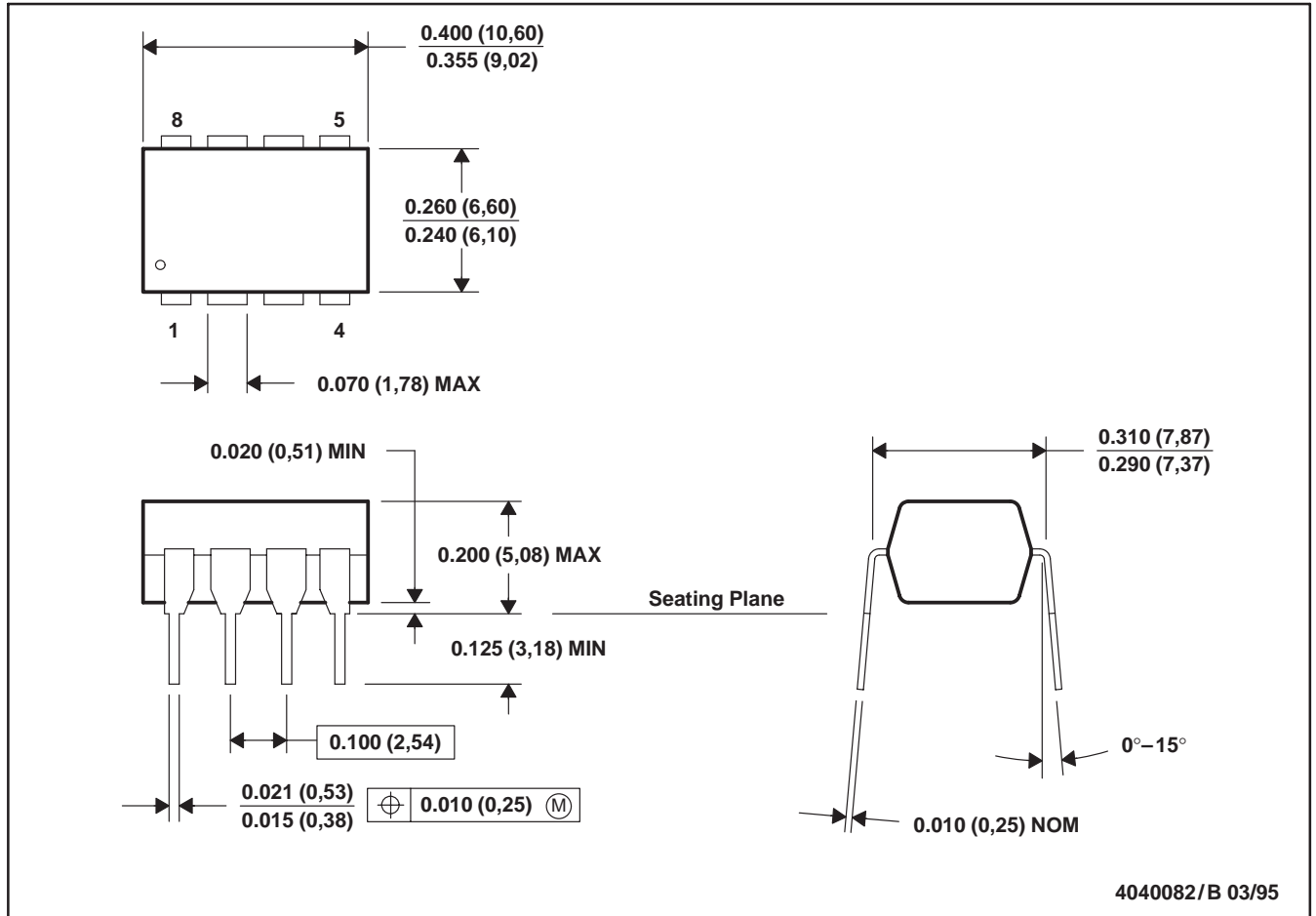

- NOTES: A. All linear dimensions are in inches (millimeters).  
 B. This drawing is subject to change without notice.  
 C. Falls within JEDEC MS-001

**TLV226x, TLV226xA**  
**Advanced LinCMOS™ RAIL-TO-RAIL**  
**OPERATIONAL AMPLIFIERS**

SLOS186A – FEBRUARY 1997 – REVISED JULY 1999

**MECHANICAL INFORMATION**

**PW (R-PDSO-G\*\*)**

**PLASTIC SMALL-OUTLINE PACKAGE**

14 PIN SHOWN

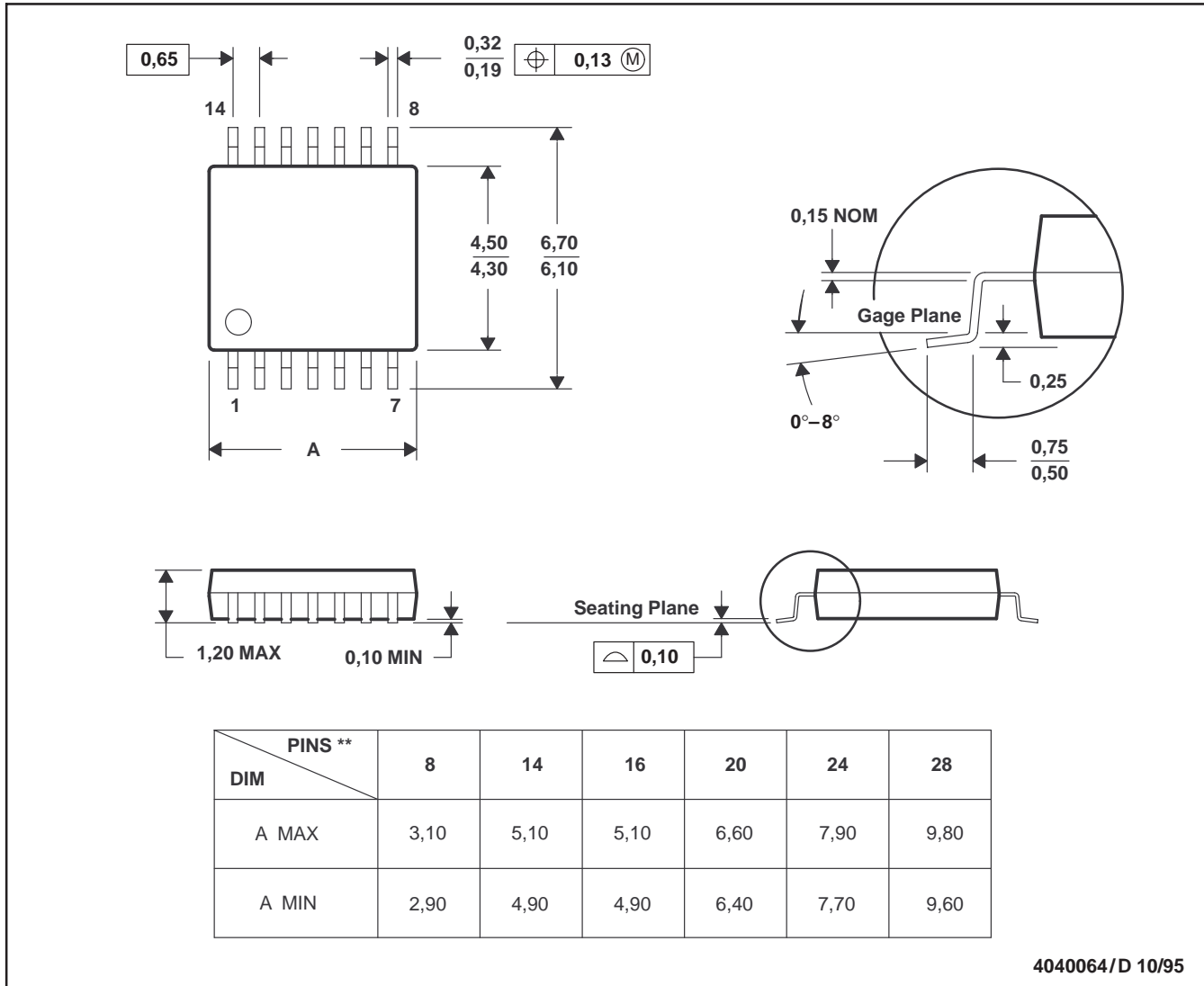

4040064/D 10/95

- NOTES: A. All linear dimensions are in millimeters.  
 B. This drawing is subject to change without notice.  
 C. Body dimensions do not include mold flash or protrusion not to exceed 0,15.  
 D. Falls within JEDEC MO-153



MECHANICAL INFORMATION

U (S-GDFP-F10)

CERAMIC DUAL FLATPACK

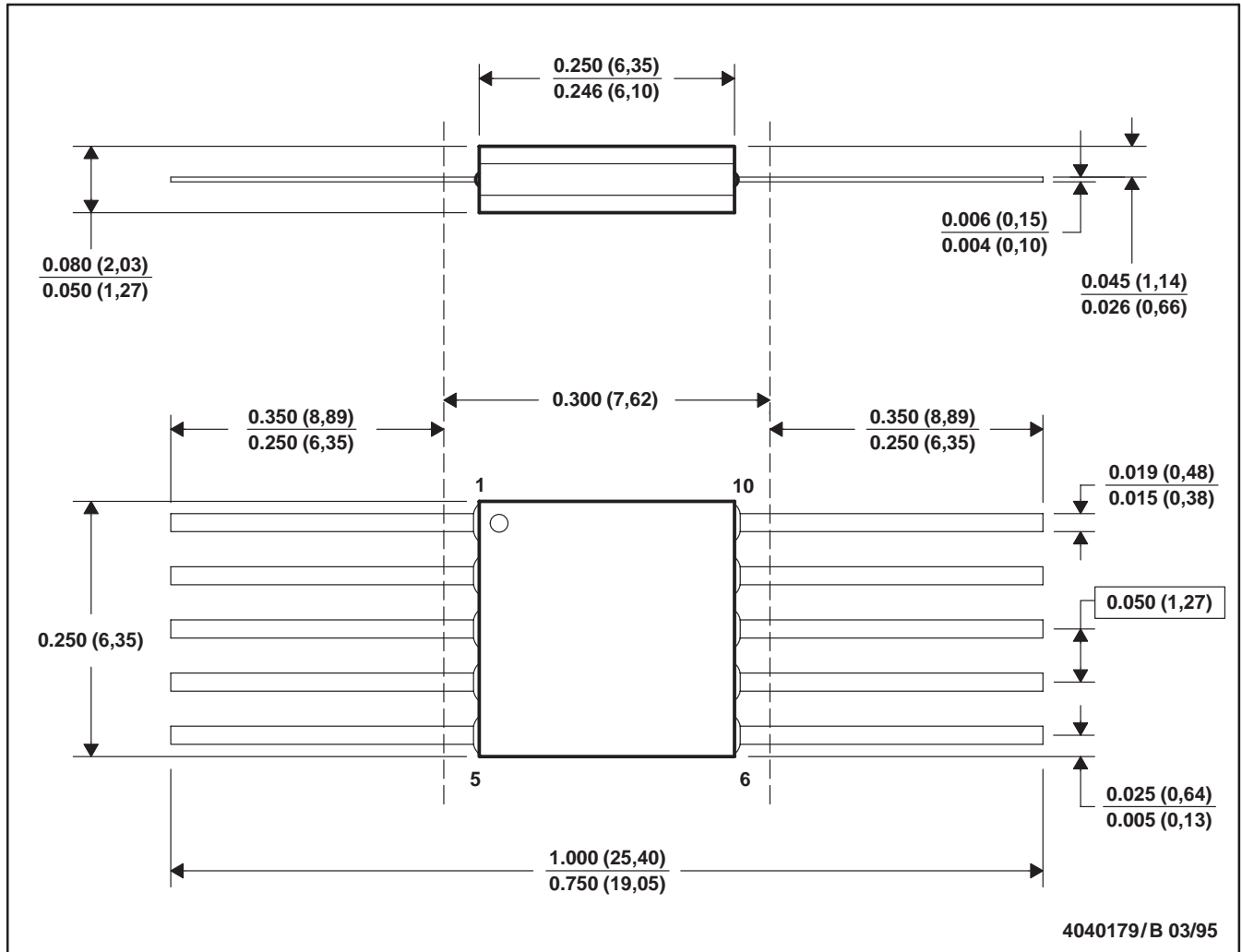

- NOTES: A. All linear dimensions are in inches (millimeters).  
 B. This drawing is subject to change without notice.  
 C. This package can be hermetically sealed with a ceramic lid using glass frit.  
 D. Index point is provided on cap for terminal identification only.  
 E. Falls within MIL STD 1835 GDFP1-F10 and JEDEC MO-092AA

**TLV226x, TLV226xA**  
**Advanced LinCMOS™ RAIL-TO-RAIL**  
**OPERATIONAL AMPLIFIERS**

SLOS186A – FEBRUARY 1997 – REVISED JULY 1999

**MECHANICAL INFORMATION**

**W (R-GDFP-F16)**

**CERAMIC DUAL FLATPACK**

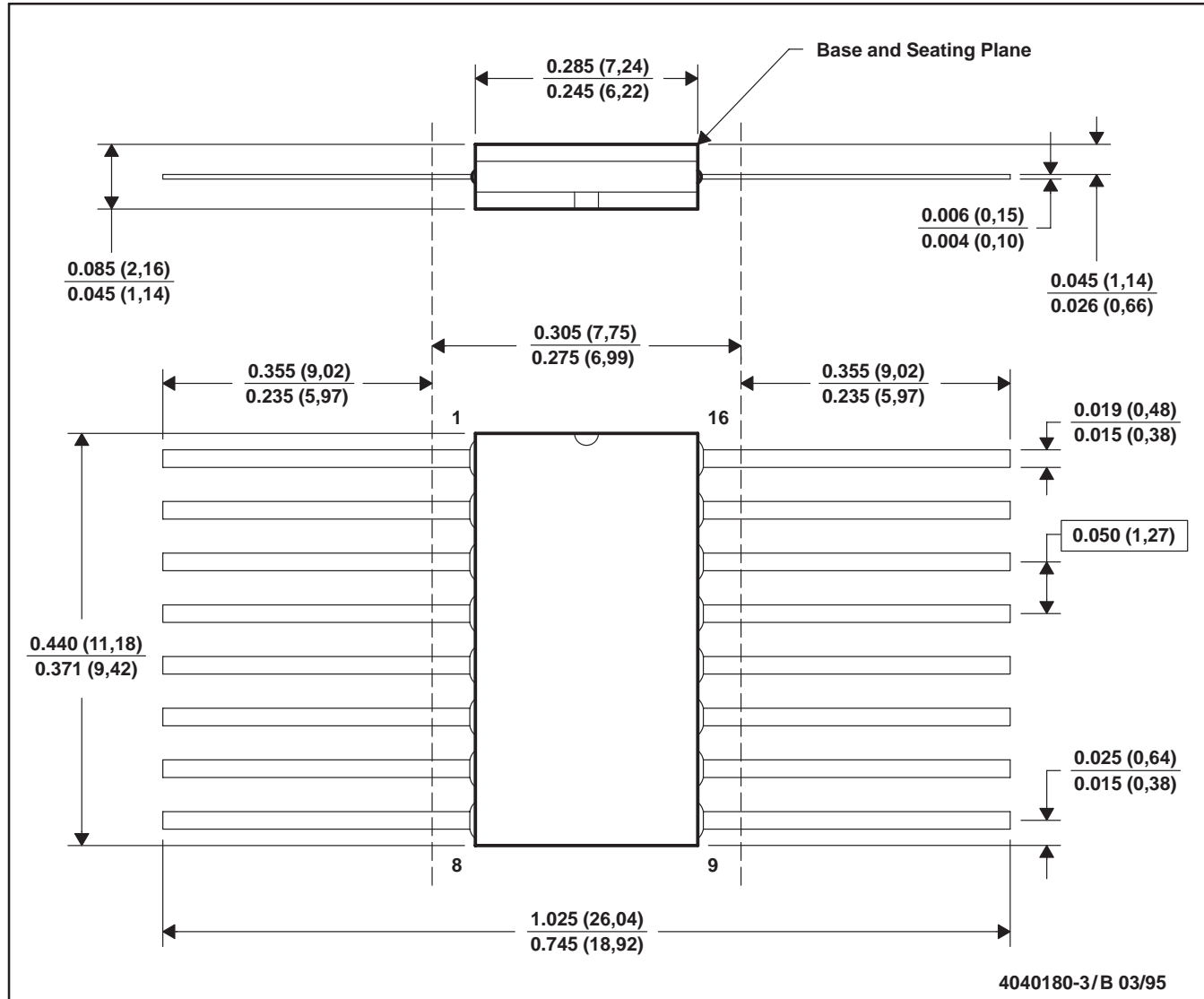

- NOTES: A. All linear dimensions are in inches (millimeters).  
 B. This drawing is subject to change without notice.  
 C. This package can be hermetically sealed with a ceramic lid using glass frit.  
 D. Index point is provided on cap for terminal identification only.  
 E. Falls within MIL-STD-1835 GDFP1-F16 and JEDEC MO-092AC



## IMPORTANT NOTICE

Texas Instruments and its subsidiaries (TI) reserve the right to make changes to their products or to discontinue any product or service without notice, and advise customers to obtain the latest version of relevant information to verify, before placing orders, that information being relied on is current and complete. All products are sold subject to the terms and conditions of sale supplied at the time of order acknowledgement, including those pertaining to warranty, patent infringement, and limitation of liability.

TI warrants performance of its semiconductor products to the specifications applicable at the time of sale in accordance with TI's standard warranty. Testing and other quality control techniques are utilized to the extent TI deems necessary to support this warranty. Specific testing of all parameters of each device is not necessarily performed, except those mandated by government requirements.

CERTAIN APPLICATIONS USING SEMICONDUCTOR PRODUCTS MAY INVOLVE POTENTIAL RISKS OF DEATH, PERSONAL INJURY, OR SEVERE PROPERTY OR ENVIRONMENTAL DAMAGE ("CRITICAL APPLICATIONS"). TI SEMICONDUCTOR PRODUCTS ARE NOT DESIGNED, AUTHORIZED, OR WARRANTED TO BE SUITABLE FOR USE IN LIFE-SUPPORT DEVICES OR SYSTEMS OR OTHER CRITICAL APPLICATIONS. INCLUSION OF TI PRODUCTS IN SUCH APPLICATIONS IS UNDERSTOOD TO BE FULLY AT THE CUSTOMER'S RISK.

In order to minimize risks associated with the customer's applications, adequate design and operating safeguards must be provided by the customer to minimize inherent or procedural hazards.

TI assumes no liability for applications assistance or customer product design. TI does not warrant or represent that any license, either express or implied, is granted under any patent right, copyright, mask work right, or other intellectual property right of TI covering or relating to any combination, machine, or process in which such semiconductor products or services might be or are used. TI's publication of information regarding any third party's products or services does not constitute TI's approval, warranty or endorsement thereof.

Copyright © Each Manufacturing Company.

All Datasheets cannot be modified without permission.

This datasheet has been download from :

[www.AllDataSheet.com](http://www.AllDataSheet.com)

100% Free DataSheet Search Site.

Free Download.

No Register.

Fast Search System.

[www.AllDataSheet.com](http://www.AllDataSheet.com)