

# TMS27C210A 65536 BY 16-BIT UV ERASABLE TMS27PC210A 65536 BY 16-BIT PROGRAMMABLE READ-ONLY MEMORIES

SMLS310D—NOVEMBER 1990—REVISED SEPTEMBER 1997

- Organization . . . 65536 by 16 Bits
- Single 5-V Power Supply
- Operationally Compatible With Existing Megabit EPROMs
- 40-Pin Dual-In-Line Package and 44-Lead Plastic Leaded Chip Carrier
- All Inputs/Outputs Fully TTL Compatible
- $\pm 10\%$   $V_{CC}$  Tolerance
- Maximum Access/Minimum Cycle Time
 

'27C/PC210A-10	100	ns
'27C/PC210A-12	120	ns
'27C/PC210A-15	150	ns
'27C/PC210A-20	200	ns
'27C/PC210A-25	250	ns
- 16-Bit Output For Use in Microprocessor-Based Systems
- Very High-Speed SNAP! Pulse Programming
- Power-Saving CMOS Technology
- 3-State Output Buffers
- 400-mV Minimum DC Noise Immunity With Standard TTL Loads
- Latchup Immunity of 250 mA on All Input and Output Pins
- No Pullup Resistors Required
- Low Power Dissipation
  - Active . . . 275 mW Worst Case
  - Standby . . . 0.55 mW Worst Case (CMOS-Input Levels)
- Temperature Range Options

J PACKAGE  
(TOP VIEW)

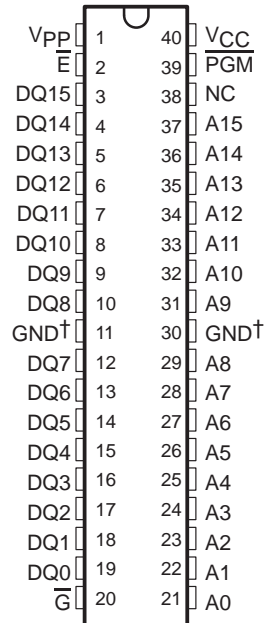

FN PACKAGE  
(TOP VIEW)

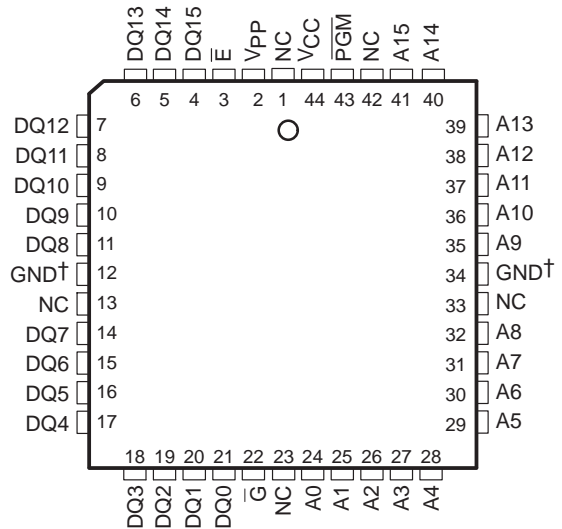

## PIN NOMENCLATURE

A0–A15	Address Inputs
DQ0–DQ15	Inputs (programming)/Outputs
E	Chip Enable
G	Output Enable
GND	Ground
NC	No Internal Connection
PGM	Program
VCC	5-V Power Supply
VPP	13-V Power Supply†

† Pins 11 and 30 (J package) and pins 12 and 34 (FN package) must be connected externally to ground.

‡ Only in program mode



Please be aware that an important notice concerning availability, standard warranty, and use in critical applications of Texas Instruments semiconductor products and disclaimers thereto appears at the end of this data sheet.

PRODUCTION DATA information is current as of publication date. Products conform to specifications per the terms of Texas Instruments standard warranty. Production processing does not necessarily include testing of all parameters.

**TEXAS  
INSTRUMENTS**

POST OFFICE BOX 1443 • HOUSTON, TEXAS 77251-1443

Copyright © 1997, Texas Instruments Incorporated

# TMS27C210A 65536 BY 16-BIT UV ERASABLE TMS27PC210A 65536 BY 16-BIT PROGRAMMABLE READ-ONLY MEMORIES

SMLS310D–NOVEMBER 1990 – REVISED SEPTEMBER 1997

---

## description

The TMS27C210A series are 65536 by 16-bit (1048576-bit), ultraviolet-light erasable, electrically programmable read-only memories (EPROMs).

The TMS27PC210A series are 65536 by 16-bit (1048576-bit), one-time programmable (OTP) electrically programmable read-only memories (PROMs).

These devices are fabricated using power-saving CMOS technology for high speed and simple interface with MOS and bipolar circuits. All inputs (including program data inputs) can be driven by Series 74 TTL circuits without the use of external pullup resistors. Each output can drive one Series 74 TTL circuit without external resistors.

The TMS27C210A EPROM is offered in a dual-in-line ceramic package (J suffix) designed for insertion in mounting hole rows on 15,2-mm (600-mil) centers. The TMS27C210A is offered with two choices of temperature ranges, 0°C to 70°C (JL suffix) and –40°C to 85°C (JE suffix). See Table 1.

The TMS27PC210A OTP PROM is offered in a 44-pin plastic leaded chip carrier package using 1,25-mm (50-mil) lead spacing (FN suffix). The TMS27PC210A is offered with two choices of temperature ranges, 0°C to 70°C (FNL suffix) and –40°C to 85°C (FNE suffix). See Table 1.

**Table 1. Temperature Range Suffixes**

EPROM AND OTP PROM	SUFFIX FOR OPERATING FREE-AIR TEMPERATURE RANGES	
	0°C to 70°C	–40°C to 85°C
TMS27C210A-xx	JL	JE
TMS27PC210A-xx	FNL	FNE

These EPROMs and OTP PROMs operate from a single 5-V supply (in the read mode), they are ideal for use in microprocessor based systems. One other (13 V) supply is needed for programming. All programming signals are TTL level. For programming outside the system, existing EPROM programmers can be used.

## operation

The seven modes of operation for the TMS27C210A and TMS27PC210A are listed in Table 2. The read mode requires a single 5-V supply. All inputs are TTL level except for  $V_{PP}$  during programming (13 V), and 12 V on A9 for signature mode.



**Table 2. Operation Modes**

FUNCTION	MODE†							
	READ	OUTPUT DISABLE	STANDBY	PROGRAMMING	VERIFY	PROGRAM INHIBIT	SIGNATURE MODE	
$\bar{E}$	V <sub>IL</sub>	V <sub>IL</sub>	V <sub>IH</sub>	V <sub>IL</sub>	V <sub>IL</sub>	V <sub>IH</sub>	V <sub>IL</sub>	
$\bar{G}$	V <sub>IL</sub>	V <sub>IH</sub>	X	V <sub>IH</sub>	V <sub>IL</sub>	X	V <sub>IL</sub>	
PGM	X	X	X	V <sub>IL</sub>	V <sub>IH</sub>	X	X	
V <sub>PP</sub>	V <sub>CC</sub>	V <sub>CC</sub>	V <sub>CC</sub>	V <sub>PP</sub>	V <sub>PP</sub>	V <sub>PP</sub>	V <sub>CC</sub>	
V <sub>CC</sub>	V <sub>CC</sub>	V <sub>CC</sub>	V <sub>CC</sub>	V <sub>CC</sub>	V <sub>CC</sub>	V <sub>CC</sub>	V <sub>CC</sub>	
A9	X	X	X	X	X	X	V <sub>H</sub> ‡   V <sub>H</sub> ‡	
A0	X	X	X	X	X	X	V <sub>IL</sub>   V <sub>IH</sub>	
DQ0–DQ15	Data Out	Hi-Z	Hi-Z	Data In	Data Out	Hi-Z	CODE	
							MFG	DEVICE
							97	AB

† X can be V<sub>IL</sub> or V<sub>IH</sub>.

‡ V<sub>H</sub> = 12 V ± 0.5 V.

### read/output disable

When the outputs of two or more TMS27C210As or TMS27PC210As are connected in parallel on the same bus, the output of any particular device in the circuit can be read with no interference from competing outputs of the other devices. To read the output of a single device, a low level signal is applied to the  $\bar{E}$  and  $\bar{G}$  pins. All other devices in the circuit must have their outputs disabled by applying a high level signal to one of these pins.

### latchup immunity

Latchup immunity on the TMS27C210A and TMS27PC210A is a minimum of 250 mA on all inputs and outputs. This feature provides latchup immunity beyond any potential transients at the P.C. board level when the EPROM is interfaced to industry standard TTL or MOS logic devices. The input/output layout approach controls latchup without compromising performance or packing density.

For more information see application report SMLA001, "Design Considerations; Latchup Immunity of the HVCMOS EPROM Family", available through TI Sales Offices.

### power down

Active I<sub>CC</sub> supply current can be reduced from 50 mA to 500 μA by applying a high TTL input on  $\bar{E}$  and to 100 μA by applying a high CMOS input on  $\bar{E}$ . In this mode all outputs are in the high-impedance state.

### erasure (TMS27C210A)

Before programming, the TMS27C210A is erased by exposing the chip through the transparent lid to a high intensity ultraviolet light (wavelength 2537 Å). The recommended minimum exposure dose (UV intensity × exposure time) is 15-W•s/cm<sup>2</sup>. A typical 12-mW/cm<sup>2</sup>, filterless UV lamp erases the device in 21 minutes. The lamp should be located about 2.5 cm above the chip during erasure. After erasure, all bits are in the high state. Normal ambient light contains the correct wavelength for erasure; therefore, when using the TMS27C210A the window should be covered with an opaque label.

### initializing (TMS27PC210A)

The OTP TMS27PC210A PROM is provided with all bits in the logic high state then logic lows are programmed into the desired locations. Logic lows programmed into an OTP PROM cannot be erased.

# TMS27C210A 65536 BY 16-BIT UV ERASABLE TMS27PC210A 65536 BY 16-BIT PROGRAMMABLE READ-ONLY MEMORIES

SMLS310D—NOVEMBER 1990—REVISED SEPTEMBER 1997

## SNAP! Pulse programming

The TMS27C210A and TMS27PC210A are programmed using the TI SNAP! Pulse programming algorithm (shown in the flow chart in Figure 1), which can program in a nominal time of seven seconds. Actual programming time varies as a function of the programmer used.

The SNAP! Pulse programming algorithm uses an initial pulse of 100 microseconds ( $\mu\text{s}$ ) followed by a byte verification to determine when the addressed byte has been successfully programmed. Up to 10 (ten) 100- $\mu\text{s}$  pulses per byte are provided before a failure is recognized.

The programming mode is achieved when  $V_{PP} = 13\text{ V}$ ,  $V_{CC} = 6.5\text{ V}$ ,  $\overline{E} = V_{IL}$ ,  $\overline{G} = V_{IH}$ . Data is presented in parallel (16 bits) on pins DQ0 through DQ15. Once addresses and data are stable,  $\overline{PGM}$  is pulsed low.

More than one device can be programmed when the devices are connected in parallel. Locations can be programmed in any order. When the SNAP! Pulse programming routine is complete, all bits are verified with  $V_{CC} = V_{PP} = 5\text{ V} \pm 10\%$ .

## program inhibit

Programming can be inhibited by maintaining a high level input on the  $\overline{E}$  or  $\overline{PGM}$  pins.

## program verify

Programmed bits can be verified with  $V_{PP} = 13\text{ V}$  when  $\overline{G} = V_{IL}$ ,  $\overline{E} = V_{IL}$ , and  $\overline{PGM} = V_{IH}$ .

## signature mode

The signature mode provides access to a binary code identifying the manufacturer and type. This mode is activated when A9 is forced to 12 V. Two identifier bytes are accessed by toggling A0. DQ0–DQ7 contain the valid codes. All other addresses must be held low. The signature code for these devices is 97AB. A0 low selects the manufacturer's code 97 (Hex), and A0 high selects the device code AB (Hex), as shown in Table 3.

**Table 3. Signature Mode**

IDENTIFIERT	PINS									
	A0	DQ7	DQ6	DQ5	DQ4	DQ3	DQ2	DQ1	DQ0	HEX
Manufacturer Code	$V_{IL}$	1	0	0	1	0	1	1	1	97
Device Code	$V_{IH}$	1	0	1	0	1	0	1	1	AB

†  $\overline{E} = \overline{G} = V_{IL}$ , A9 =  $V_{IH}$ , A1–A8 =  $V_{IL}$ , A10–A15 =  $V_{IL}$ ,  $V_{PP} = V_{CC}$ ,  $\overline{PGM} = V_{IH}$  or  $V_{IL}$ .

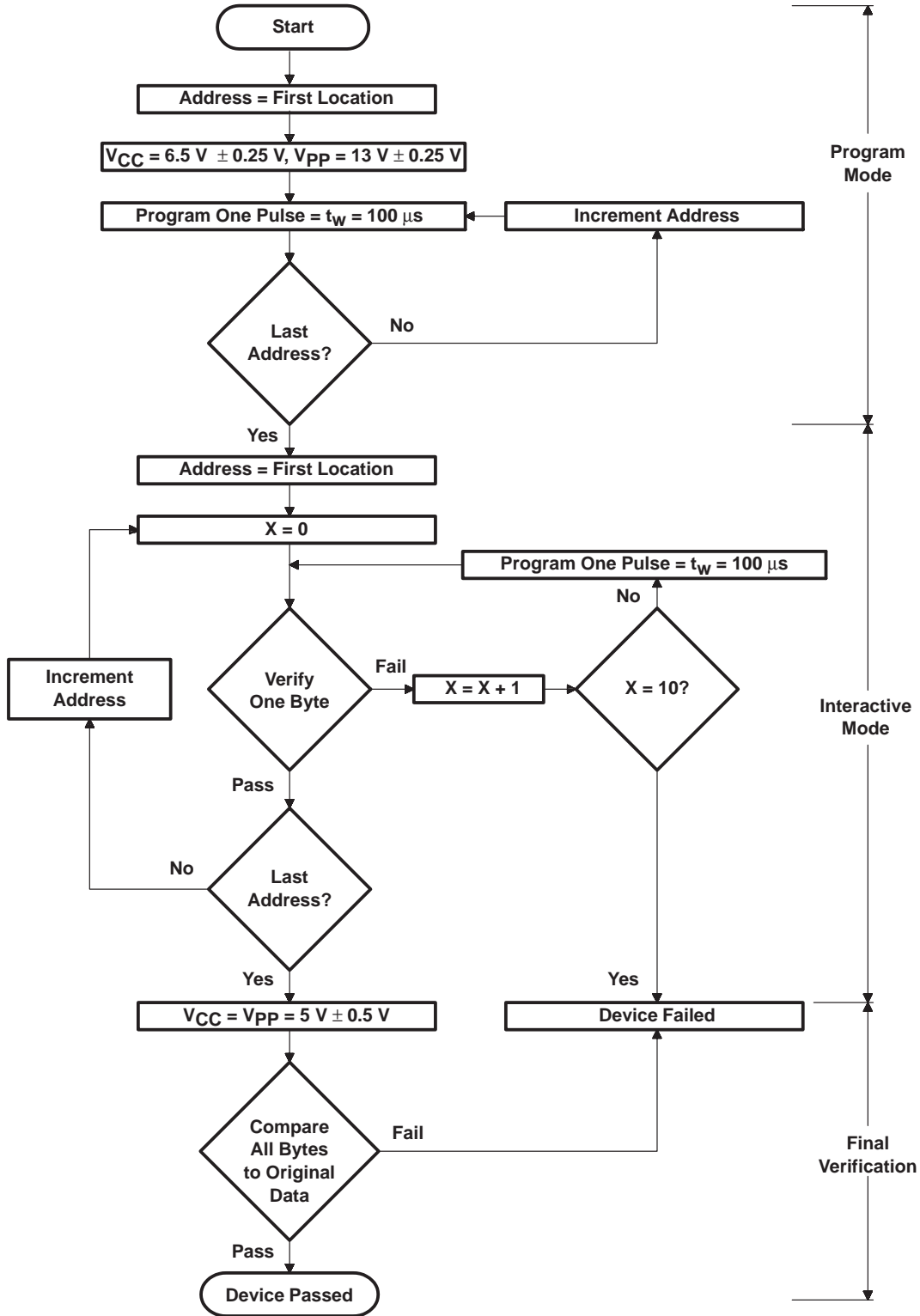
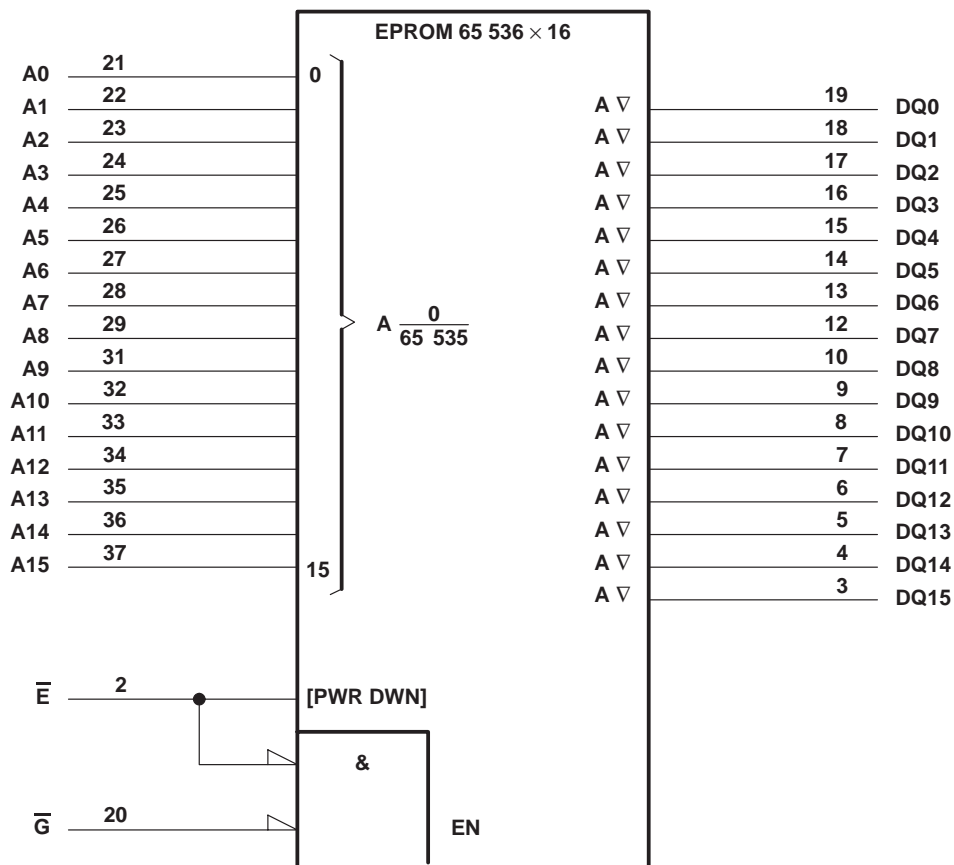

Figure 1. SNAP! Pulse Programming Flowchart

**TMS27C210A 65536 BY 16-BIT UV ERASABLE  
TMS27PC210A 65536 BY 16-BIT  
PROGRAMMABLE READ-ONLY MEMORIES**

SMLS310D—NOVEMBER 1990—REVISED SEPTEMBER 1997

**logic symbol†**



† This symbol is in accordance with ANSI/IEEE Std 91–1984 and IEC Publication 617–12.

**TMS27C210A 65536 BY 16-BIT UV ERASABLE  
TMS27PC210A 65536 BY 16-BIT  
PROGRAMMABLE READ-ONLY MEMORIES**  
SMLS310D–NOVEMBER 1990 – REVISED SEPTEMBER 1997

**absolute maximum ratings over operating free-air temperature range (unless otherwise noted)†**

Supply voltage range, $V_{CC}$ (see Note 1)	–0.6 V to 7 V
Supply voltage range, $V_{PP}$	–0.6 V to 14 V
Input voltage range (see Note 1): All inputs except A9	–0.6 V to $V_{CC} + 1$ V
A9	–0.6 V to 13.5 V
Output voltage range (see Note 1)	–0.6 V to $V_{CC} + 1$ V
Operating free-air temperature range ('27C210A-__JL, '27PC210A-__FNL)	0° C to 70° C
Operating free-air temperature range ('27C210A-__JE, '27PC210A-__FNE)	–40° C to 85° C
Storage temperature range, $T_{stg}$	–65° C to 150° C

† Stresses beyond those listed under “absolute maximum ratings” may cause permanent damage to the device. These are stress ratings only, and functional operation of the device at these or any other conditions beyond those indicated under “recommended operating conditions” is not implied. Exposure to absolute-maximum-rated conditions for extended periods may affect device reliability.

NOTE 1: All voltage values are with respect to GND.

**recommended operating conditions**

		TMS27C/PC210A-10 TMS27C/PC210A-12 TMS27C/PC210A-15 TMS27C/PC210A-20 TMS27C/PC210A-25			UNIT	
		MIN	NOM	MAX		
$V_{CC}$	Supply voltage	Read mode (see Note 2)	4.5	5	5.5	V
		SNAP! Pulse programming algorithm	6.25	6.5	6.75	
$V_{PP}$	Supply voltage	Read mode	$V_{CC}-0.6$	$V_{CC}$	$V_{CC}+0.6$	V
		SNAP! Pulse programming algorithm	12.75	13	13.25	
$V_{IH}$	High-level dc input voltage	TTL	2	$V_{CC}+0.5$		V
		CMOS	$V_{CC}-0.2$		$V_{CC}+0.5$	
$V_{IL}$	Low-level dc input voltage	TTL	–0.5	0.8		V
		CMOS	–0.5	GND+0.2		
$T_A$	Operating free-air temperature	'27C210A-__JL '27PC210A-__FNL	0	70		°C
$T_A$	Operating free-air temperature	'27C210A-__JE, '27PC210A-__FNE	–40	85		°C

NOTE 2:  $V_{CC}$  must be applied before or at the same time as  $V_{PP}$  and removed after or at the same time as  $V_{PP}$ . The device must not be inserted into or removed from the board when  $V_{PP}$  or  $V_{CC}$  is applied.



**TMS27C210A 65536 BY 16-BIT UV ERASABLE  
TMS27PC210A 65536 BY 16-BIT  
PROGRAMMABLE READ-ONLY MEMORIES**

SMLS310D—NOVEMBER 1990—REVISED SEPTEMBER 1997

**electrical characteristics over recommended ranges of operating conditions**

PARAMETER		TEST CONDITIONS	MIN	MAX	UNIT
V <sub>OH</sub>	High-level dc output voltage	I <sub>OH</sub> = -20 μA	V <sub>CC</sub> - 0.2		V
		I <sub>OH</sub> = -2 mA	2.4		
V <sub>OL</sub>	Low-level dc output voltage	I <sub>OL</sub> = 2.1 mA	0.4		V
		I <sub>OL</sub> = 20 μA	0.1		
I <sub>I</sub>	Input current (leakage)	V <sub>I</sub> = 0 V to 5.5 V	±1		μA
I <sub>O</sub>	Output current (leakage)	V <sub>O</sub> = 0 V to V <sub>CC</sub>	±1		μA
I <sub>PP1</sub>	V <sub>PP</sub> supply current	V <sub>PP</sub> = V <sub>CC</sub> = 5.5 V	10		μA
I <sub>PP2</sub>	V <sub>PP</sub> supply current (during program pulse)	V <sub>PP</sub> = 13 V	50		mA
I <sub>CC1</sub>	V <sub>CC</sub> supply current (standby)	TTL-input level	V <sub>CC</sub> = 5.5 V, $\bar{E} = V_{IH}$		μA
		CMOS-input level	V <sub>CC</sub> = 5.5 V, $\bar{E} = V_{CC}$		
I <sub>CC2</sub>	V <sub>CC</sub> supply current (active)	V <sub>CC</sub> = 5.5 V, $\bar{E} = V_{IL}$ , t <sub>cycle</sub> = minimum cycle time, outputs open†	50		mA

† Minimum cycle time = maximum address access time.

**capacitance over recommended ranges of supply voltage and operating free-air temperature, f = 1 MHz‡**

PARAMETER		TEST CONDITIONS	MIN	TYP§	MAX	UNIT
C <sub>I</sub>	Input capacitance	V <sub>I</sub> = 0 V, f = 1 MHz	8	12		pF
C <sub>O</sub>	Output capacitance	V <sub>O</sub> = 0 V, f = 1 MHz	12	15		pF

‡ Capacitance measurements are made on a sample basis only.

§ Typical values are at T<sub>A</sub> = 25°C and nominal voltages.

**switching characteristics over full ranges of recommended operating conditions (see Notes 3 and 4)**

PARAMETER	TEST CONDITIONS	'27C210A-10 '27PC210A-10		'27C210A-12 '27PC210A-12		'27C210A-15 '27PC210A-15		'27C210A-20 '27PC210A-20		'27C210A-25 '27PC210A-25		UNIT
		MIN	MAX	MIN	MAX	MIN	MAX	MIN	MAX	MIN	MAX	
t <sub>a(A)</sub>	Access time from address	100		120		150		200		250		ns
t <sub>a(E)</sub>	Access time from chip enable	100		120		150		200		250		ns
t <sub>en(G)</sub>	Output enable time from $\bar{G}$	55		55		75		75		100		ns
t <sub>dis</sub>	Output disable time from $\bar{G}$ or $\bar{E}$ , whichever occurs first†	0	50	0	50	0	60	0	60	0	60	ns
t <sub>v(A)</sub>	Output data valid time after change of address, $\bar{E}$ , or $\bar{G}$ , whichever occurs first†	0		0		0		0		0		ns

† Value calculated from 0.5 V delta to measured level. This parameter is only sampled and not 100% tested.

NOTES: 3. For all switching characteristics, the input pulse levels are 0.4 V to 2.4 V. Timing measurements are made at 2 V for logic high and 0.8 V for logic low (see Figure 2).

4. Common test conditions apply for t<sub>dis</sub> except during programming.





**TMS27C210A 65536 BY 16-BIT UV ERASABLE**  
**TMS27PC210A 65536 BY 16-BIT**  
**PROGRAMMABLE READ-ONLY MEMORIES**  
SMLS310D–NOVEMBER 1990 – REVISED SEPTEMBER 1997

**switching characteristics for programming:  $V_{CC} = 6.5\text{ V}$  and  $V_{PP} = 13\text{ V}$  (SNAP! Pulse),  $T_A = 25^\circ\text{C}$  (see Note 3)**

PARAMETER		MIN	MAX	UNIT
$t_{dis}(G)$	Output disable time from $\overline{G}$	0	100	ns
$t_{en}(G)$	Output enable time from $\overline{G}$		150	ns

NOTE 3: For all switching characteristics, the input pulse levels are 0.4 V to 2.4 V. Timing measurements are made at 2 V for logic high and 0.8 V for logic low (See Figure 2).

**timing requirements for programming**

		MIN	NOM	MAX	UNIT		
$t_w(\text{PGM})$	Pulse duration, program	SNAP! Pulse programming algorithm		95	100	105	$\mu\text{s}$
$t_{su}(A)$	Setup time, address	2					$\mu\text{s}$
$t_{su}(E)$	Setup time, $\overline{E}$	2					$\mu\text{s}$
$t_{su}(G)$	Setup time, $\overline{G}$	2					$\mu\text{s}$
$t_{su}(D)$	Setup time, data	2					$\mu\text{s}$
$t_{su}(V_{PP})$	Setup time, $V_{PP}$	2					$\mu\text{s}$
$t_{su}(V_{CC})$	Setup time, $V_{CC}$	2					$\mu\text{s}$
$t_h(A)$	Hold time, address	0					$\mu\text{s}$
$t_h(D)$	Hold time, data	2					$\mu\text{s}$

NOTE 3: For all switching characteristics, the input pulse levels are 0.4 V to 2.4 V. Timing measurements are made at 2 V for logic high and 0.8 V for logic low (See Figure 2).

TMS27C210A 65536 BY 16-BIT UV ERASABLE  
TMS27PC210A 65536 BY 16-BIT  
PROGRAMMABLE READ-ONLY MEMORIES

SMLS310D—NOVEMBER 1990—REVISED SEPTEMBER 1997

PARAMETER MEASUREMENT INFORMATION

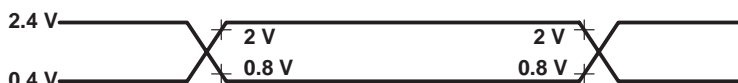
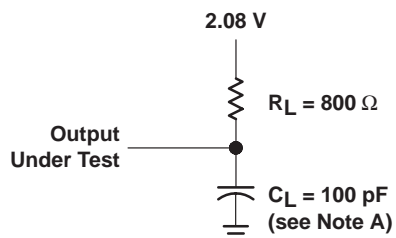

- NOTES: A.  $C_L$  includes probe and fixture capacitance.  
B. The ac testing inputs are driven at 2.4 V for logic high and 0.4 V for logic low. Timing measurements are made at 2 V for logic high and 0.8 V for logic low for both inputs and outputs.

Figure 2. The ac Testing Output Load Circuit and ac Waveform

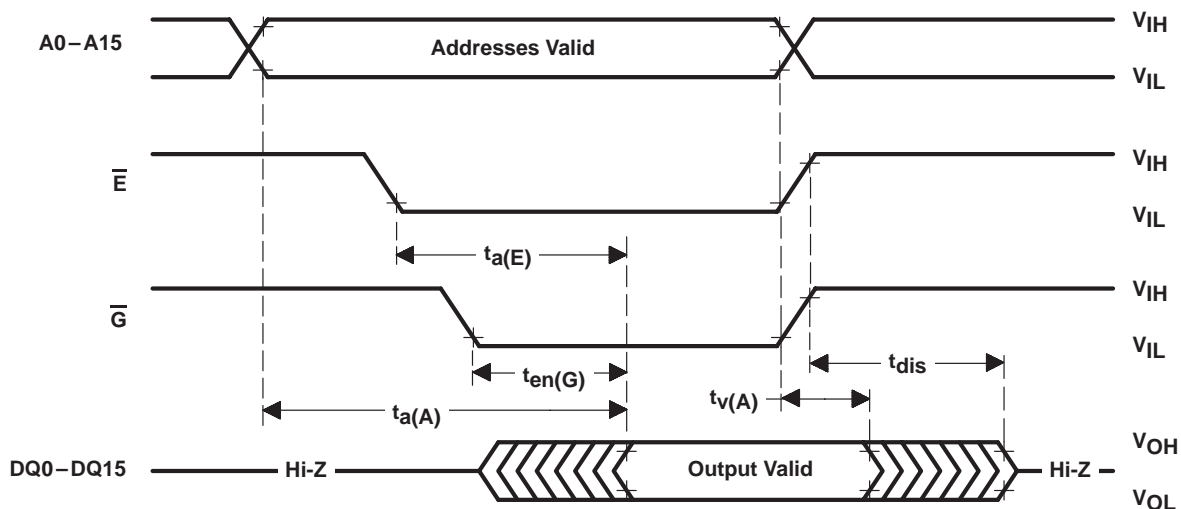
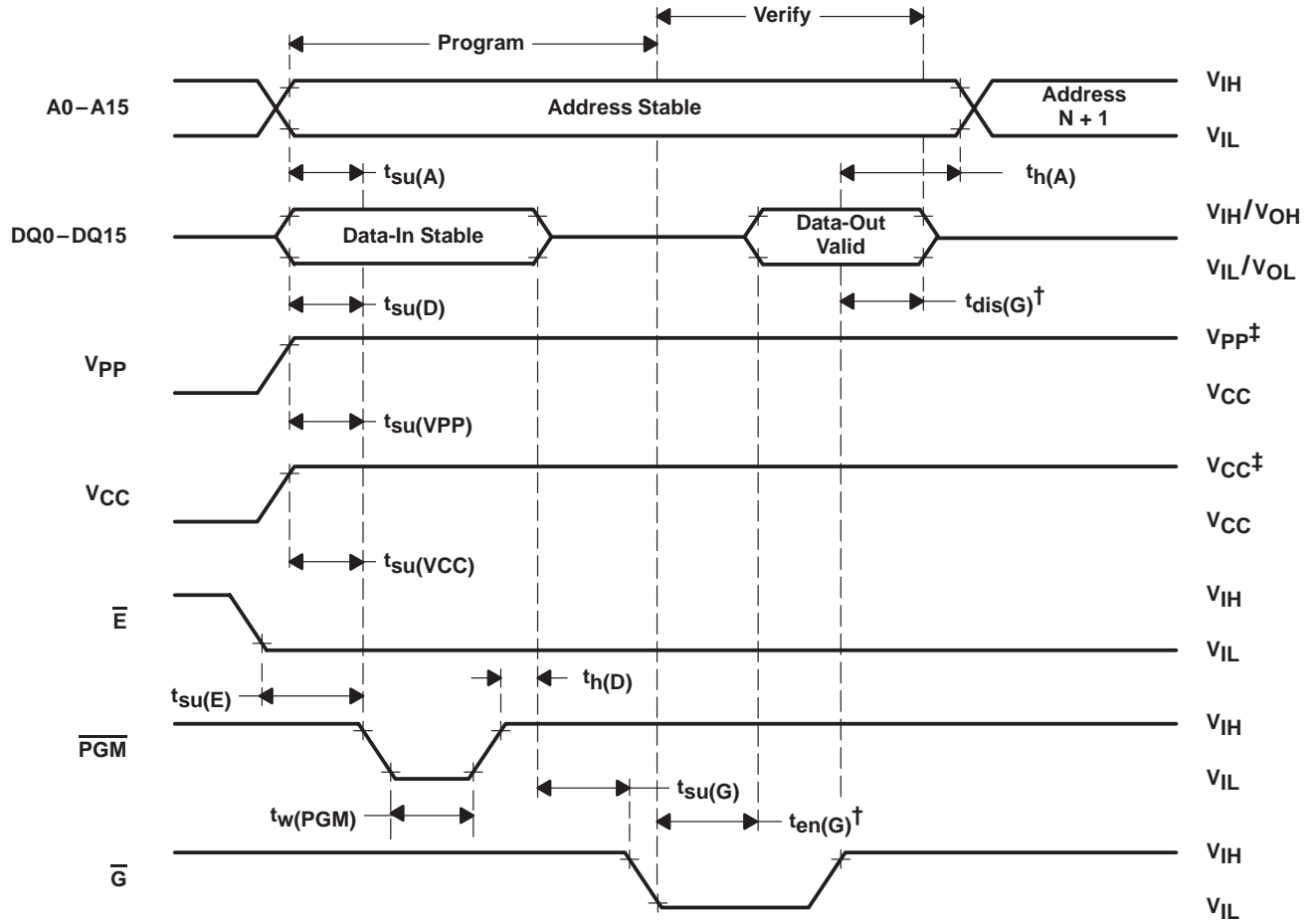

Figure 3. Read-Cycle Timing

PROGRAMMING INFORMATION



<sup>†</sup>  $t_{dis}(G)$  and  $t_{en}(G)$  are characteristics of the device but must be accommodated by the programmer.

<sup>‡</sup> 13-V V<sub>PP</sub> and 6.5-V V<sub>CC</sub> for SNAP! Pulse programming.

Figure 4. Program-Cycle Timing (SNAP! Pulse Programming)

**TMS27C210A 65536 BY 16-BIT UV ERASABLE  
TMS27PC210A 65536 BY 16-BIT  
PROGRAMMABLE READ-ONLY MEMORIES**

SMLS310D—NOVEMBER 1990—REVISED SEPTEMBER 1997

**FN (S-PQCC-J\*\*)**

**PLASTIC J-LEADED CHIP CARRIER**

20 PIN SHOWN

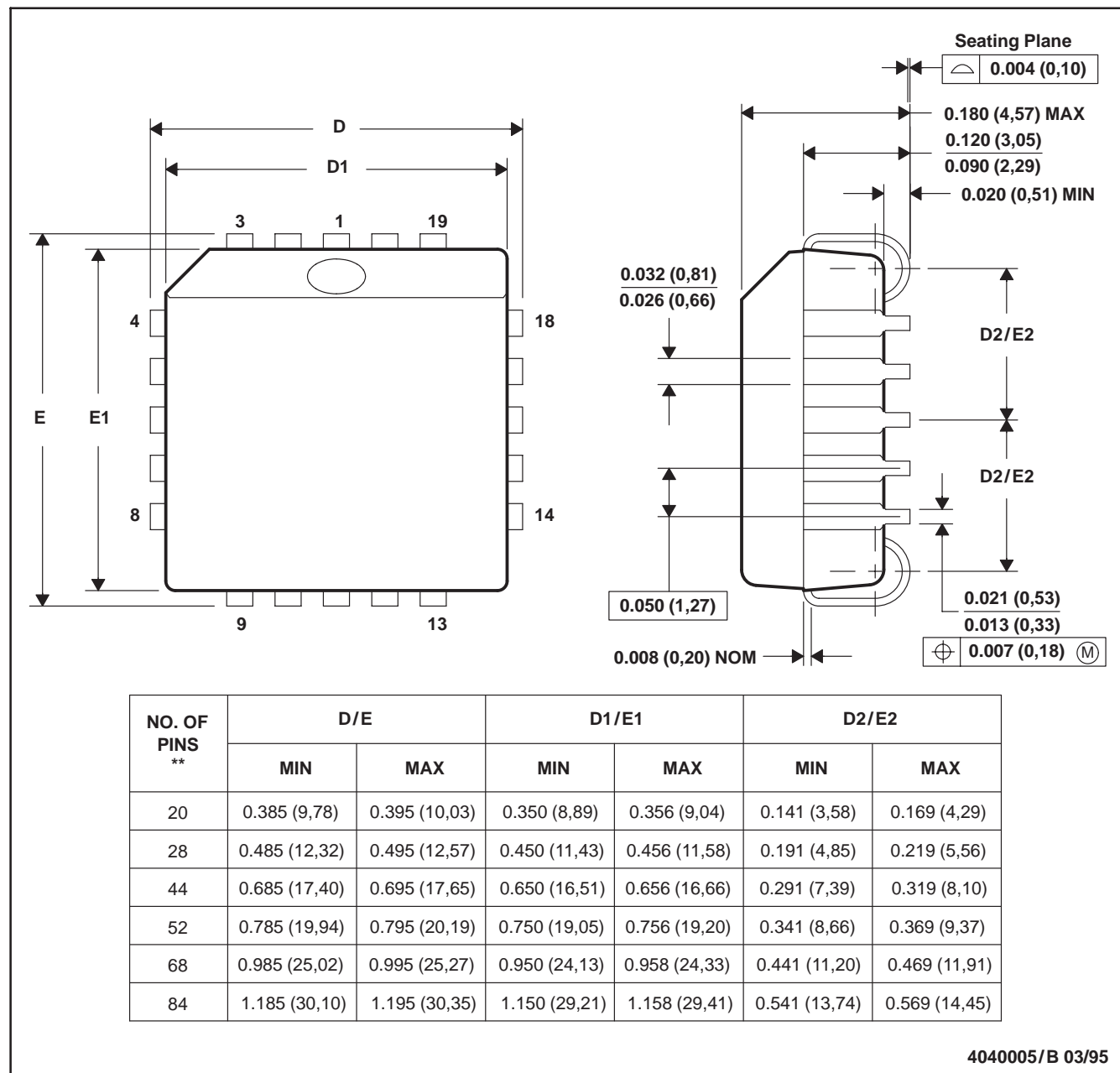

NOTES: A. All linear dimensions are in inches (millimeters).  
B. This drawing is subject to change without notice.  
C. Falls within JEDEC MS-018

TMS27C210A 65536 BY 16-BIT UV ERASABLE  
TMS27PC210A 65536 BY 16-BIT  
PROGRAMMABLE READ-ONLY MEMORIES  
SMLS310D—NOVEMBER 1990—REVISED SEPTEMBER 1997

J (R-CDIP-T\*\*)

CERAMIC SIDE-BRAZE DUAL-IN-LINE PACKAGE

24 PIN SHOWN

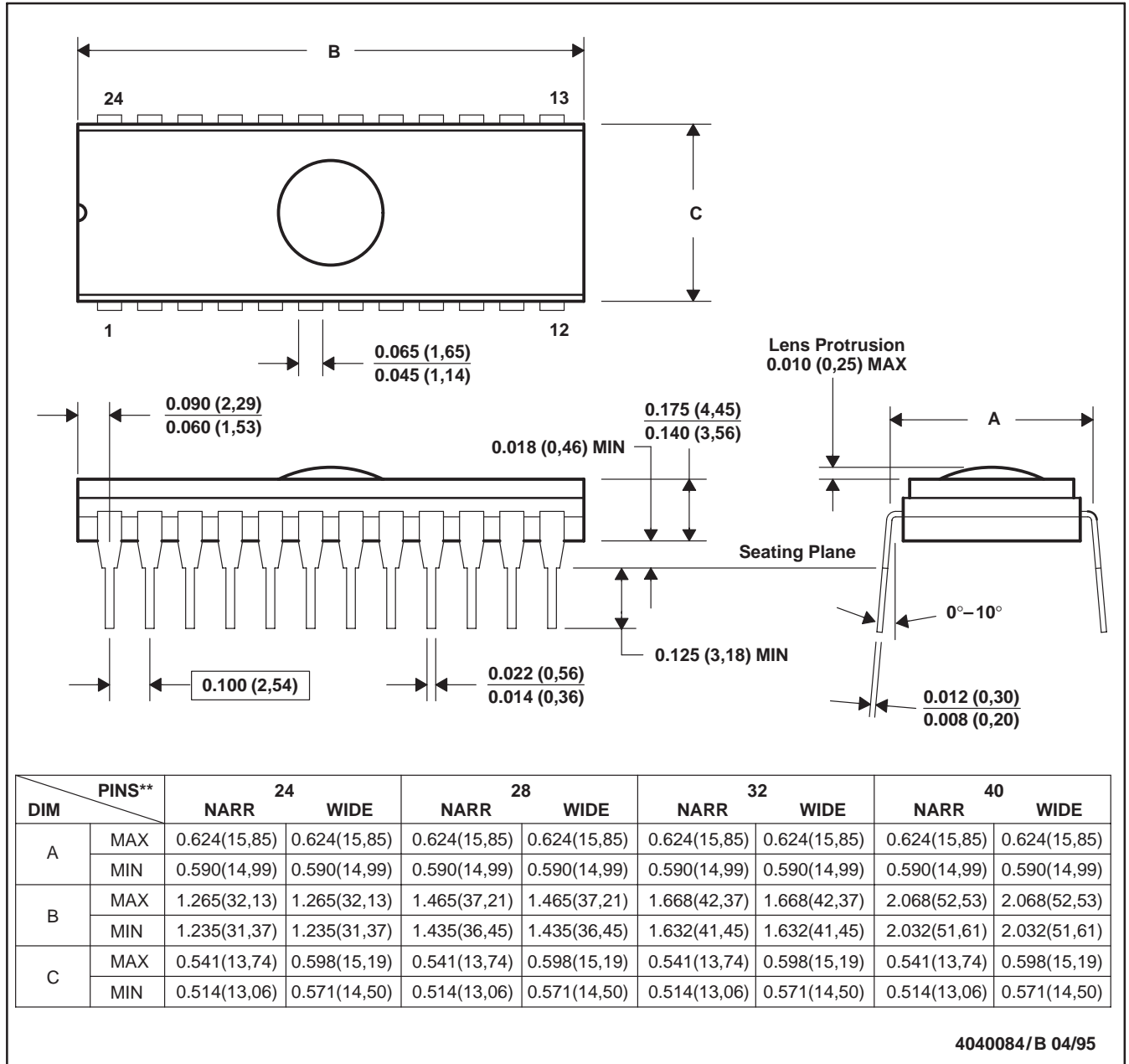

- NOTES: A. All linear dimensions are in inches (millimeters).  
B. This drawing is subject to change without notice.  
C. This package can be hermetically sealed with a ceramic lid using glass frit.  
D. Index point is provided on cap for terminal identification only on press ceramic glass frit seal only.



**TMS27C210A 65536 BY 16-BIT UV ERASABLE  
TMS27PC210A 65536 BY 16-BIT  
PROGRAMMABLE READ-ONLY MEMORIES**

SMLS310D– NOVEMBER 1990 – REVISED SEPTEMBER 1997

---



## IMPORTANT NOTICE

Texas Instruments and its subsidiaries (TI) reserve the right to make changes to their products or to discontinue any product or service without notice, and advise customers to obtain the latest version of relevant information to verify, before placing orders, that information being relied on is current and complete. All products are sold subject to the terms and conditions of sale supplied at the time of order acknowledgement, including those pertaining to warranty, patent infringement, and limitation of liability.

TI warrants performance of its semiconductor products to the specifications applicable at the time of sale in accordance with TI's standard warranty. Testing and other quality control techniques are utilized to the extent TI deems necessary to support this warranty. Specific testing of all parameters of each device is not necessarily performed, except those mandated by government requirements.

CERTAIN APPLICATIONS USING SEMICONDUCTOR PRODUCTS MAY INVOLVE POTENTIAL RISKS OF DEATH, PERSONAL INJURY, OR SEVERE PROPERTY OR ENVIRONMENTAL DAMAGE ("CRITICAL APPLICATIONS"). TI SEMICONDUCTOR PRODUCTS ARE NOT DESIGNED, AUTHORIZED, OR WARRANTED TO BE SUITABLE FOR USE IN LIFE-SUPPORT DEVICES OR SYSTEMS OR OTHER CRITICAL APPLICATIONS. INCLUSION OF TI PRODUCTS IN SUCH APPLICATIONS IS UNDERSTOOD TO BE FULLY AT THE CUSTOMER'S RISK.

In order to minimize risks associated with the customer's applications, adequate design and operating safeguards must be provided by the customer to minimize inherent or procedural hazards.

TI assumes no liability for applications assistance or customer product design. TI does not warrant or represent that any license, either express or implied, is granted under any patent right, copyright, mask work right, or other intellectual property right of TI covering or relating to any combination, machine, or process in which such semiconductor products or services might be or are used. TI's publication of information regarding any third party's products or services does not constitute TI's approval, warranty or endorsement thereof.