

Supertex inc.

**TN0106
TN0110**

Low Threshold



**N-Channel Enhancement-Mode
Vertical DMOS FETs**

Ordering Information

BV _{DSS} / BV _{DGS}	R _{DS(ON)} (max)	I _{D(ON)} (min)	V _{GS(th)} (max)	Order Number / Package	
				TO-92	Die†
60V	3.0Ω	2A	2.0V	TN0106N3	—
100V	3.0Ω	2A	2.0V	TN0110N3	TN0110ND

† MIL visual screening available

Features

- Low threshold — 2.0V max.
- High input impedance
- Low input capacitance — 50pF typical
- Fast switching speeds
- Low on resistance
- Free from secondary breakdown
- Low input and output leakage
- Complementary N- and P-channel devices

Applications

- Logic level interfaces – ideal for TTL and CMOS
- Solid state relays
- Battery operated systems
- Photo voltaic drives
- Analog switches
- General purpose line drivers
- Telecom switches

Absolute Maximum Ratings

Drain-to-Source Voltage	BV _{DSS}
Drain-to-Gate Voltage	BV _{DGS}
Gate-to-Source Voltage	± 20V
Operating and Storage Temperature	-55°C to +150°C
Soldering Temperature*	300°C

Distance of 1.6 mm from case for 10 seconds.

Low Threshold DMOS Technology

These low threshold enhancement-mode (normally-off) transistors utilize a vertical DMOS structure and Supertex's well-proven silicon-gate manufacturing process. This combination produces devices with the power handling capabilities of bipolar transistors and with the high input impedance and positive temperature coefficient inherent in MOS devices. Characteristic of all MOS structures, these devices are free from thermal runaway and thermally-induced secondary breakdown.

Supertex's vertical DMOS FETs are ideally suited to a wide range of switching and amplifying applications where very low threshold voltage, high breakdown voltage, high input impedance, low input capacitance, and fast switching speeds are desired.

Package Options



Note: See Package Outline section for dimensions.



Thermal Characteristics

Package	I_D (continuous)*	I_D (pulsed)	Power Dissipation @ $T_C = 25^\circ\text{C}$	θ_{jc} $^\circ\text{C/W}$	θ_{ja} $^\circ\text{C/W}$	I_{DR}^*	I_{DRM}
TO-92	0.5A	2.0A	1.0W	125	170	0.5A	2.0A

* I_D (continuous) is limited by max rated T_j

Electrical Characteristics (@ 25°C unless otherwise specified)

Symbol	Parameter	Min	Typ	Max	Unit	Conditions
BV_{DSS}	Drain-to-Source Breakdown Voltage	TN0110	100			V $I_D = 1\text{mA}, V_{GS} = 0V$
		TN0106	60			
$V_{GS(th)}$	Gate Threshold Voltage	0.6		2.0	V	$V_{GS} = V_{DS}, I_D = 0.5\text{mA}$
$\Delta V_{GS(th)}$	Change in $V_{GS(th)}$ with Temperature		-3.2	-5.0	$\text{mV}/^\circ\text{C}$	$V_{GS} = V_{DS}, I_D = 1.0\text{mA}$
I_{GSS}	Gate Body Leakage			100	nA	$V_{GS} = \pm 20V, V_{DS} = 0V$
I_{DSS}	Zero Gate Voltage Drain Current			10	μA	$V_{GS} = 0V, V_{DS} = \text{Max Rating}$
				500		$V_{GS} = 0V, V_{DS} = 0.8 \text{ Max Rating}$ $T_A = 125^\circ\text{C}$
$I_{D(ON)}$	ON-State Drain Current	0.75	1.4		A	$V_{GS} = 5V, V_{DS} = 25V$
		2.0	3.4			$V_{GS} = 10V, V_{DS} = 25V$
$R_{DS(ON)}$	Static Drain-to-Source ON-State Resistance		2.0	4.5	Ω	$V_{GS} = 4.5V, I_D = 250\text{mA}$
			1.6	3.0		$V_{GS} = 10V, I_D = 500\text{mA}$
$\Delta R_{DS(ON)}$	Change in $R_{DS(ON)}$ with Temperature		0.6	1.1	$\%/^\circ\text{C}$	$I_D = 0.5A, V_{GS} = 10V$
G_{FS}	Forward Transconductance	225	400		$\text{m}\Omega$	$V_{DS} = 25V, I_D = 500\text{mA}$
C_{ISS}	Input Capacitance		50	60	pF	$V_{GS} = 0V, V_{DS} = 25V$ $f = 1 \text{ MHz}$
C_{OSS}	Common Source Output Capacitance		25	35		
C_{RSS}	Reverse Transfer Capacitance		4.0	8.0		
$t_{d(ON)}$	Turn-ON Delay Time		2.0	5.0	ns	$V_{DD} = 25V$ $I_D = 1.0A$ $R_{GEN} = 25\Omega$
t_r	Rise Time		3.0	5.0		
$t_{d(OFF)}$	Turn-OFF Delay Time		6.0	7.0		
t_f	Fall Time		3.0	6.0		
V_{SD}	Diode Forward Voltage Drop		1.0	1.5	V	$I_{SD} = 0.5A, V_{GS} = 0V$
t_{rr}	Reverse Recovery Time		400		ns	$I_{SD} = 0.5A, V_{GS} = 0V$

Notes:

- All D.C. parameters 100% tested at 25°C unless otherwise stated. (Pulse test: $300\mu\text{s}$ pulse, 2% duty cycle.)
- All A.C. parameters sample tested.

Switching Waveforms and Test Circuit

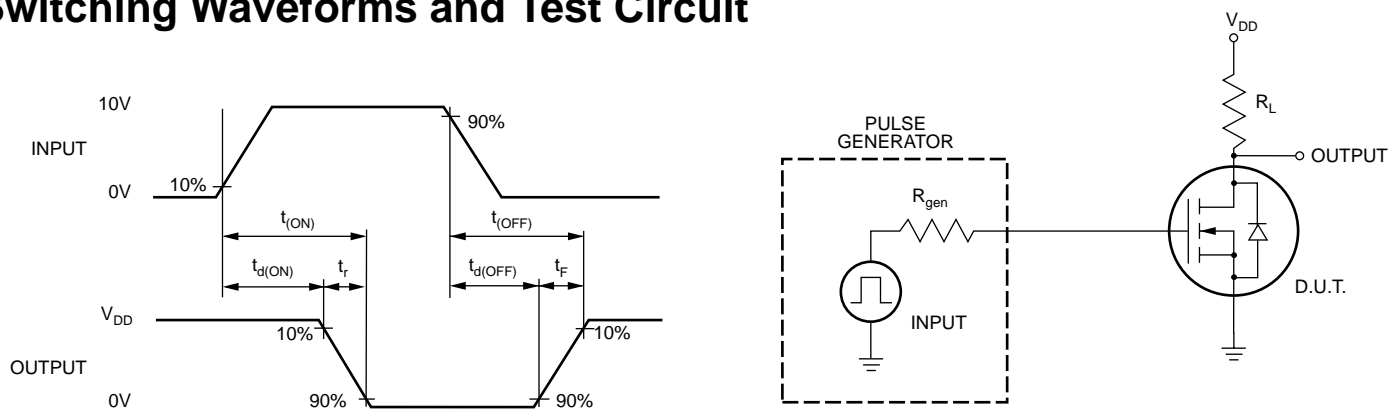

Typical Performance Curves

Output Characteristics

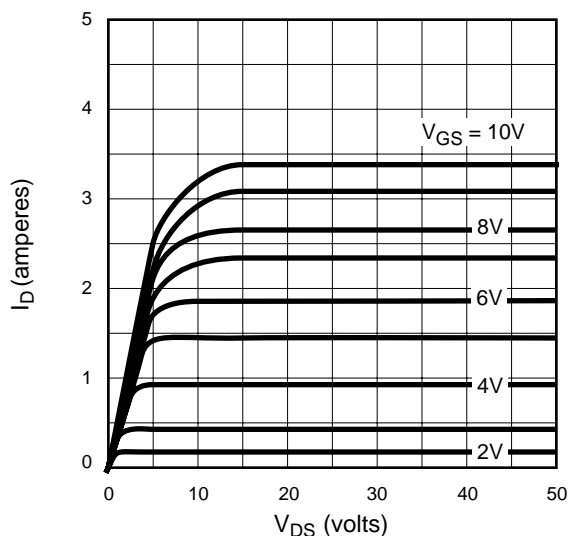

Saturation Characteristics

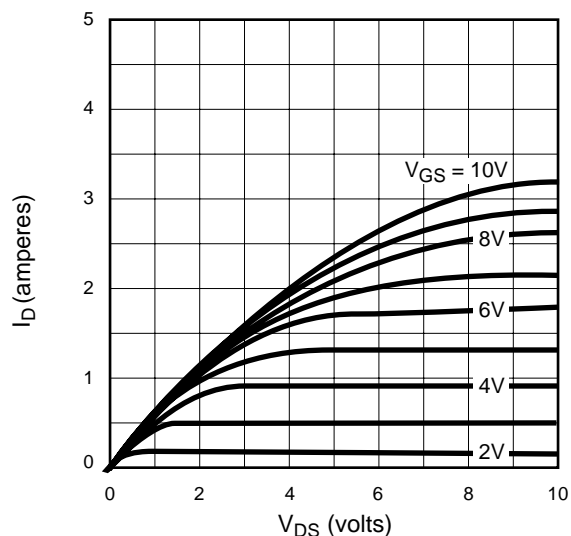

Transconductance vs. Drain Current

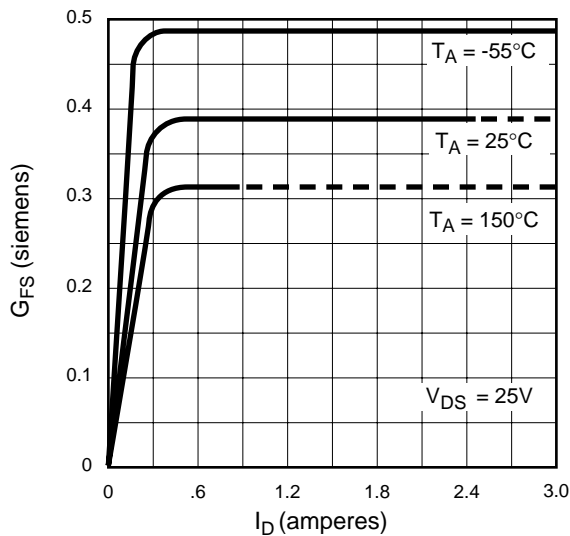

Power Dissipation vs. Case Temperature

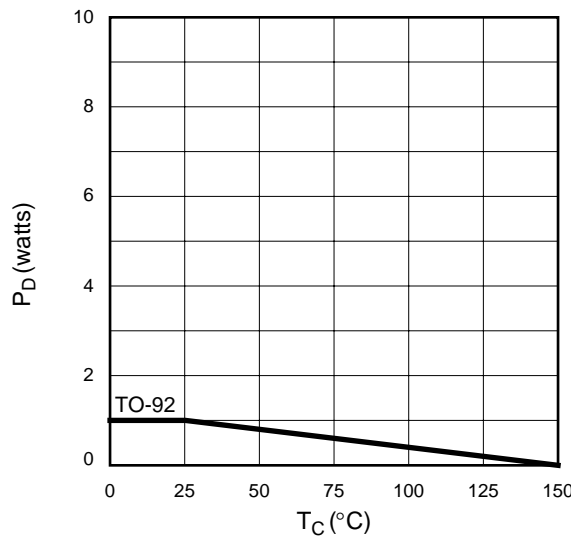

Maximum Rated Safe Operating Area

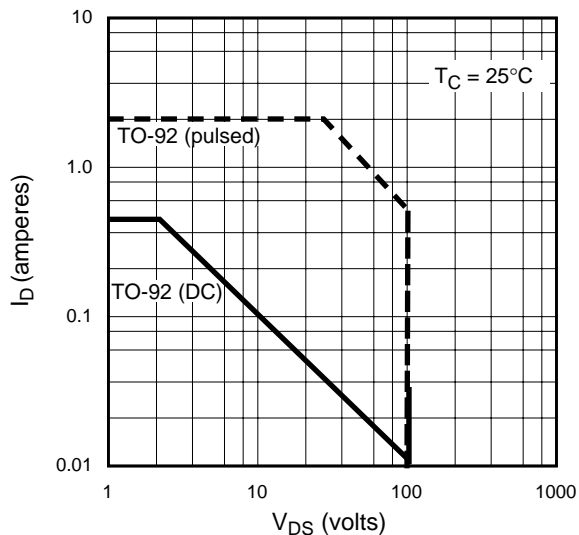

Thermal Response Characteristics

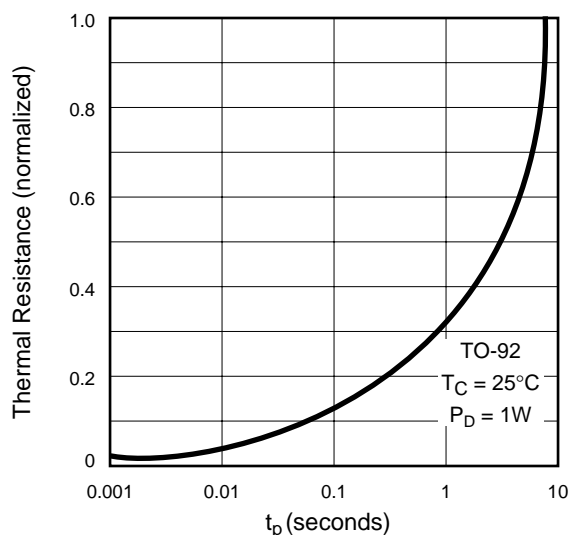

Typical Performance Curves

BV_{DSS} Variation with Temperature

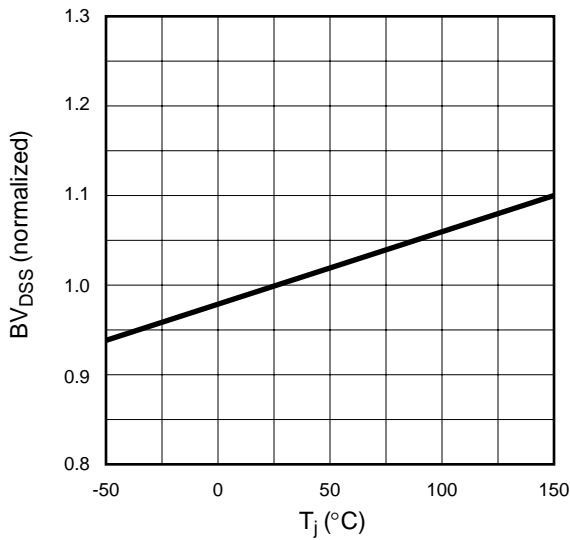

On-Resistance vs. Drain Current

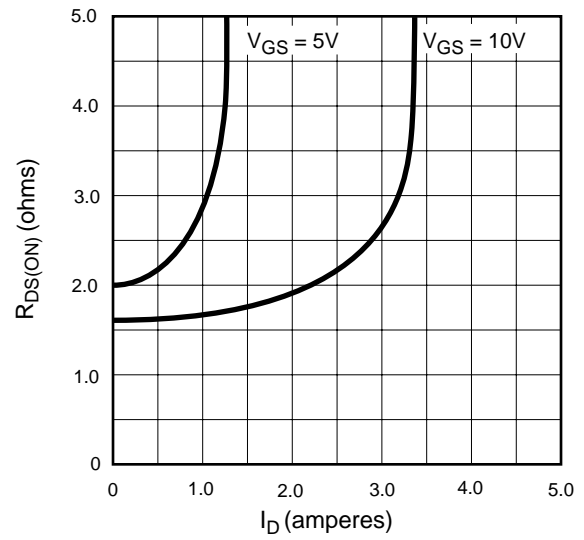

Transfer Characteristics

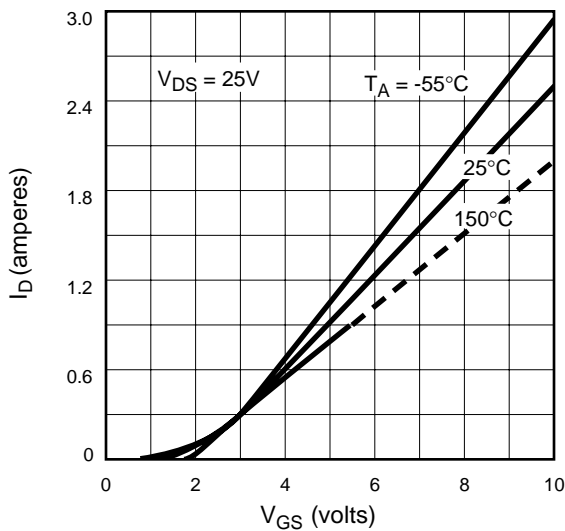

V_(th) and R_{DS} Variation with Temperature

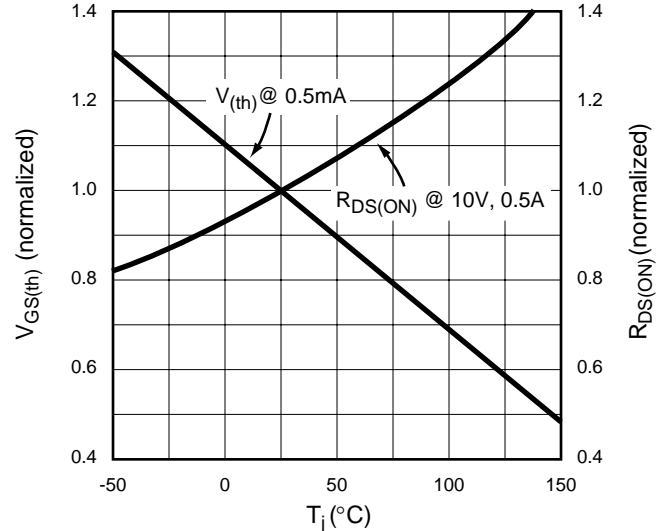

Capacitance vs. Drain-to-Source Voltage

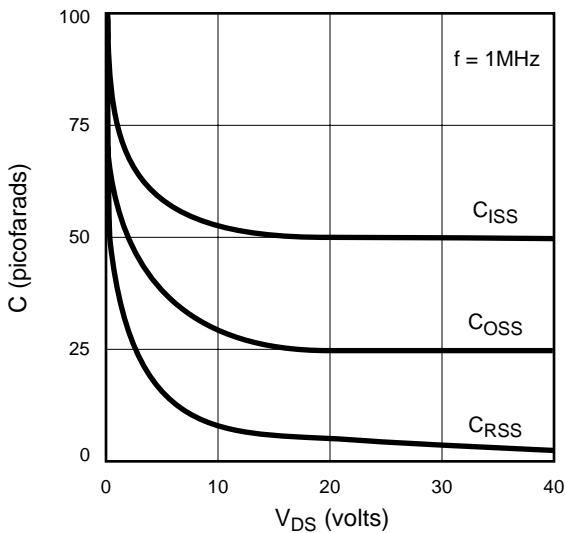

Gate Drive Dynamic Characteristics

