



# TN2410L, VN2406D/L, VN2410L/LS

## Vishay Siliconix

### N-Channel 240-V (D-S) MOSFETs

PRODUCT SUMMARY				
Part Number	V <sub>(BR)DSS</sub> Min (V)	r <sub>DS(on)</sub> Max (Ω)	V <sub>GS(th)</sub> (V)	I <sub>D</sub> (A)
TN2410L	240	10 @ V <sub>GS</sub> = 4.5 V	0.5 to 1.8	0.18
VN2406D		6 @ V <sub>GS</sub> = 10 V	0.8 to 2	1.12
VN2406L		6 @ V <sub>GS</sub> = 10 V	0.8 to 2	0.18
VN2410L		10 @ V <sub>GS</sub> = 10 V	0.8 to 2	0.18
VN2410LS		10 @ V <sub>GS</sub> = 10 V	0.8 to 2	0.19

#### FEATURES

- Low On-Resistance: 3.5 Ω
- Secondary Breakdown Free: 260 V
- Low Power/Voltage Driven
- Low Input and Output Leakage
- Excellent Thermal Stability

#### BENEFITS

- Low Offset Voltage
- Full-Voltage Operation
- Easily Driven Without Buffer
- Low Error Voltage
- No High-Temperature "Run-Away"

#### APPLICATIONS

- High-Voltage Drivers: Relays, Solenoids, Lamps, Hammers, Displays, Transistors, etc.
- Telephone Mute Switches, Ringer Circuits
- Power Supply, Converters
- Motor Control

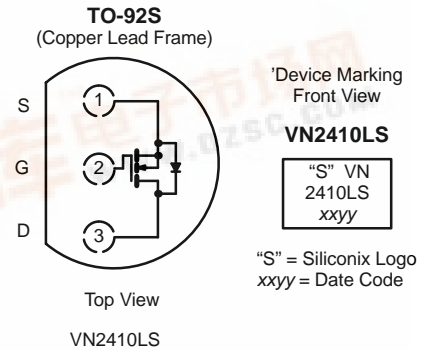
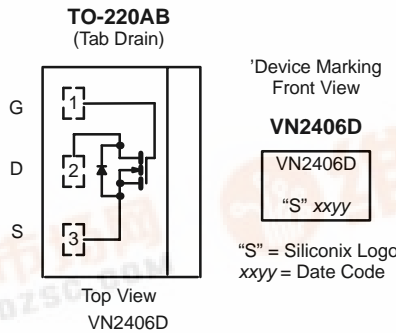
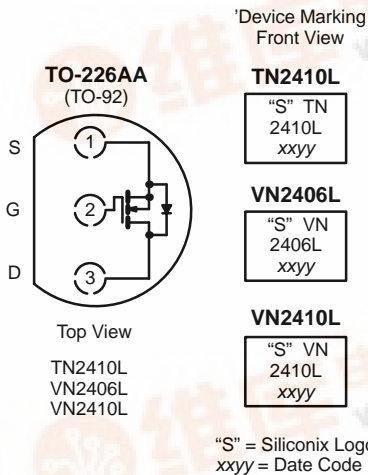

ABSOLUTE MAXIMUM RATINGS (T <sub>A</sub> = 25 °C UNLESS OTHERWISE NOTED)								
Parameter	Symbol	TN2410L	VN2406D <sup>b</sup>	VN2406L	VN2410L	VN2410LS	Unit	
Drain-Source Voltage	V <sub>DS</sub>	240	240	240	240	240	V	
Gate-Source Voltage	V <sub>GS</sub>	±20	±20	±20	±20	±20		
Continuous Drain Current (T <sub>J</sub> = 150 °C)	I <sub>D</sub>	T <sub>A</sub> = 25 °C	0.18	1.12	0.18	0.18	A	
		T <sub>A</sub> = 100 °C	0.11	0.7	0.11	0.11		
Pulsed Drain Current <sup>a</sup>	I <sub>DM</sub>	1	3	1.7	1.7	2		
Power Dissipation	P <sub>D</sub>	T <sub>A</sub> = 25 °C	0.8	20	0.8	0.8	W	
		T <sub>A</sub> = 100 °C	0.32	8	0.32	0.32		
Thermal Resistance, Junction-to-Ambient	R <sub>thJA</sub>	156	6.25°	156	156	139	°C/W	
Operating Junction and Storage Temperature Range	T <sub>J</sub> , T <sub>stg</sub>	-55 to 150						°C

Notes:  
 a. Pulse width limited by maximum junction temperature.  
 b. Reference case for all temperature testing.  
 c. Maximum junction-to-case

# TN2410L, VN2406D/L, VN2410L/LS



Vishay Siliconix

SPECIFICATIONS (T <sub>A</sub> = 25 °C UNLESS OTHERWISE NOTED)										
Parameter	Symbol	Test Conditions	Typ <sup>a</sup>	Limits						Unit
				TN2410L		VN2406D/L		VN2410L/LS		
				Min	Max	Min	Max	Min	Max	
<b>Static</b>										
Drain-Source Breakdown Voltage	V <sub>(BR)DSS</sub>	V <sub>GS</sub> = 0 V, I <sub>D</sub> = 100 μA	260	240		240		240		V
Gate-Threshold Voltage	V <sub>GS(th)</sub>	V <sub>DS</sub> = V <sub>GS</sub> , I <sub>D</sub> = 1 mA	1.4	0.5	1.8	0.8	2	0.8	2	
Gate-Body Leakage	I <sub>GSS</sub>	V <sub>DS</sub> = 0 V, V <sub>GS</sub> = ±15 V					±100		±100	nA
		T <sub>J</sub> = 125 °C					±500		±500	
Zero Gate Voltage Drain Current	I <sub>DSS</sub>	V <sub>DS</sub> = 0 V, V <sub>GS</sub> = ±20 V			±10					μA
		V <sub>DS</sub> = 192 V, V <sub>GS</sub> = 0 V	0.01		1					
		T <sub>J</sub> = 125 °C	1		100					
On-State Drain Current <sup>b</sup>	I <sub>D(on)</sub>	V <sub>DS</sub> = 120 V, V <sub>GS</sub> = 0 V					10		10	A
		T <sub>J</sub> = 125 °C					500		500	
		V <sub>DS</sub> = 10 V, V <sub>GS</sub> = 4.5 V	0.8	0.25						
Drain-Source On-Resistance <sup>b</sup>	r <sub>DS(on)</sub>	V <sub>DS</sub> = 15 V, V <sub>GS</sub> = 10 V	1.5			1		1		Ω
		V <sub>GS</sub> = 2.5 V, I <sub>D</sub> = 0.1 A	7.5				10		10	
		V <sub>GS</sub> = 3.5 V, I <sub>D</sub> = 0.05 A	4.5		15					
		V <sub>GS</sub> = 4.5 V, I <sub>D</sub> = 0.2 A	4		10					
		T <sub>J</sub> = 125 °C	7.5		20					
Forward Transconductance <sup>b</sup>	g <sub>fs</sub>	V <sub>GS</sub> = 10 V, I <sub>D</sub> = 0.2 A	500	100						mS
		V <sub>GS</sub> = 10 V, I <sub>D</sub> = 0.5 A	530			300		300		
Input Capacitance	C <sub>iss</sub>	V <sub>DS</sub> = 25 V, V <sub>GS</sub> = 0 V f = 1 MHz	115		135		135		135	pF
Output Capacitance	C <sub>oss</sub>		30		50		50		50	
Reverse Transfer Capacitance	C <sub>rss</sub>		5		20		20		20	
<b>Switching<sup>c</sup></b>										
Turn-On Time	t <sub>ON</sub>	V <sub>DD</sub> = 60 V, R <sub>L</sub> = 150 Ω I <sub>D</sub> ≅ 0.4 A, V <sub>GEN</sub> = 10 V R <sub>G</sub> = 25 Ω	5		35					ns
	t <sub>d(on)</sub>		3				8		8	
	t <sub>r</sub>		2				8		8	
Turn-Off Time	t <sub>OFF</sub>		26		60					
	t <sub>d(off)</sub>		20				23		23	
	t <sub>f</sub>		6				34		34	

**Notes**

- a. For DESIGN AID ONLY, not subject to production testing.
- b. Pulse test: PW ≤ 300 μs duty cycle ≤ 2%.
- c. Switching time is essentially independent of operating temperature.

VNDB24



# TN2410L, VN2406D/L, VN2410L/LS

Vishay Siliconix

## TYPICAL CHARACTERISTICS ( $T_A = 25^\circ\text{C}$ UNLESS OTHERWISE NOTED)

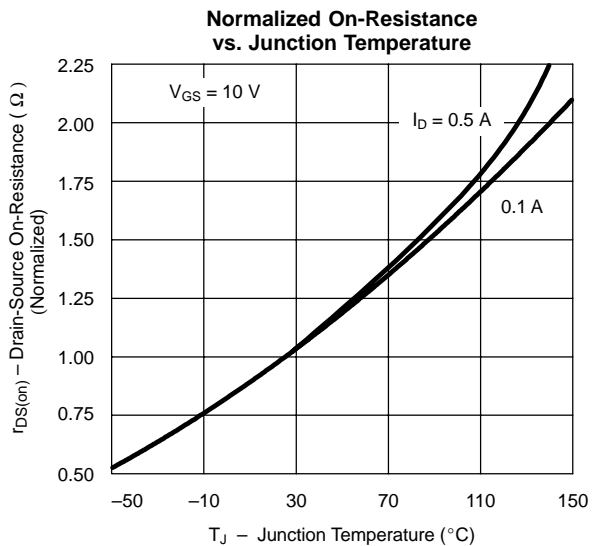
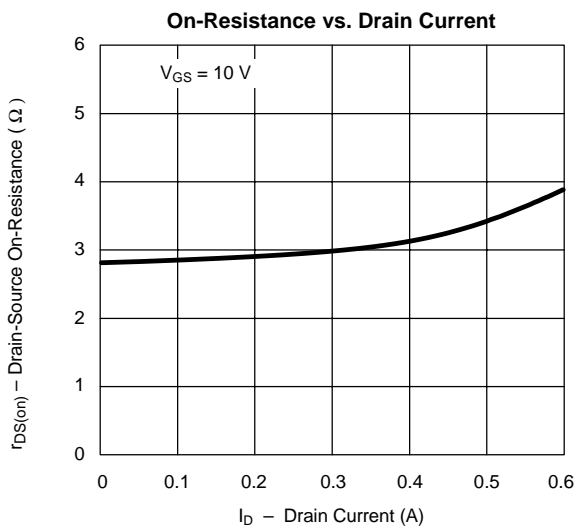
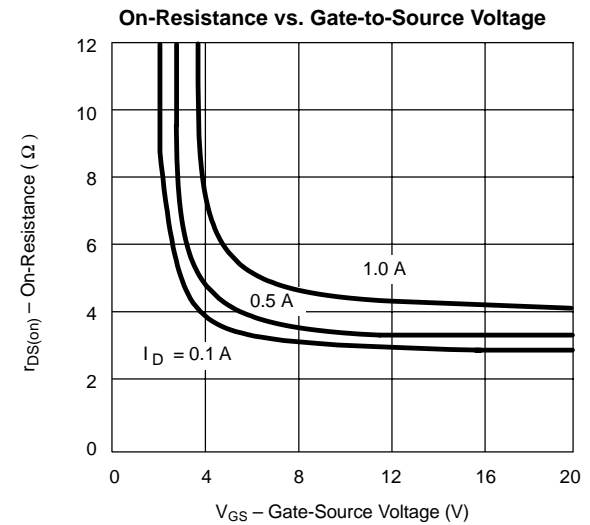
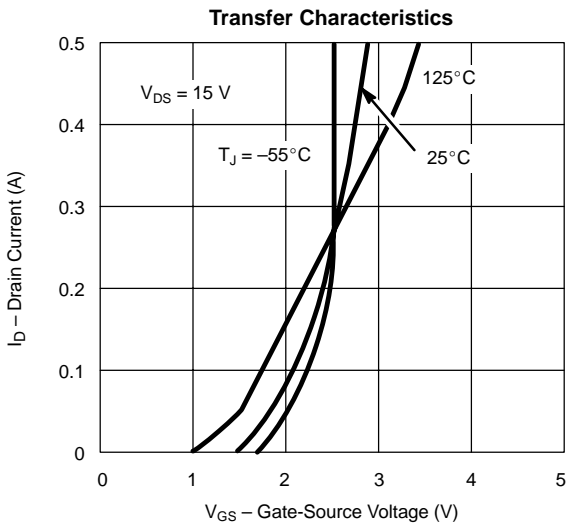
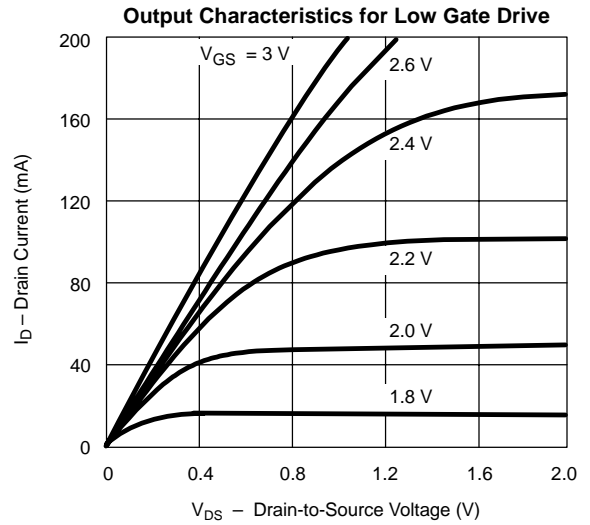
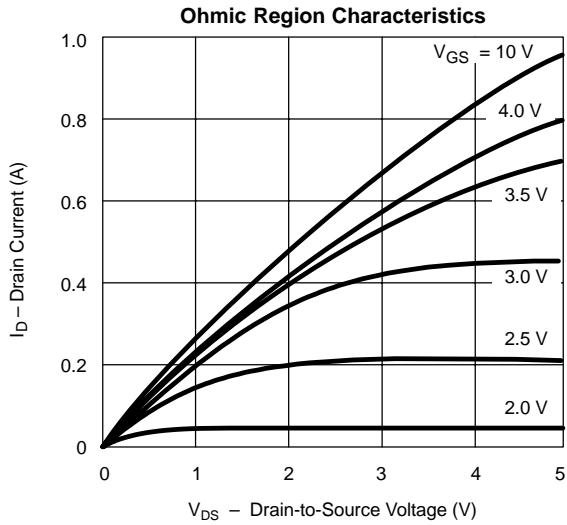



**TYPICAL CHARACTERISTICS ( $T_A = 25^\circ\text{C}$  UNLESS OTHERWISE NOTED)**

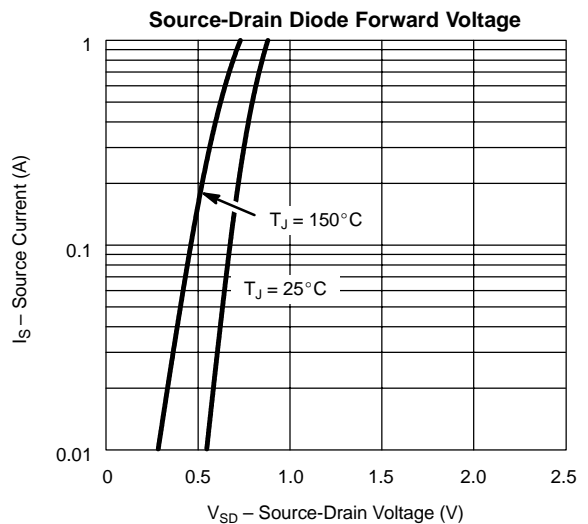
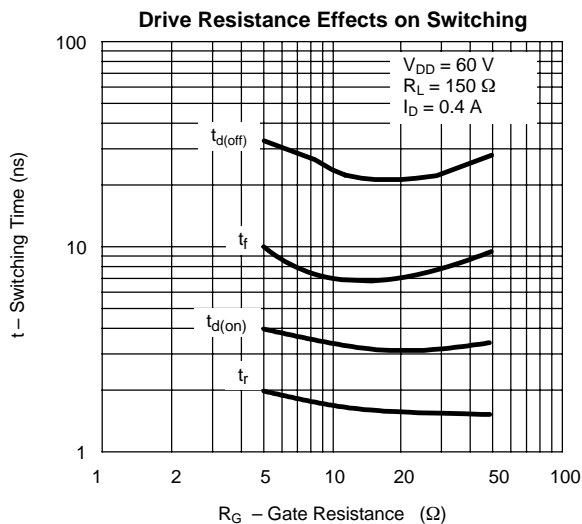
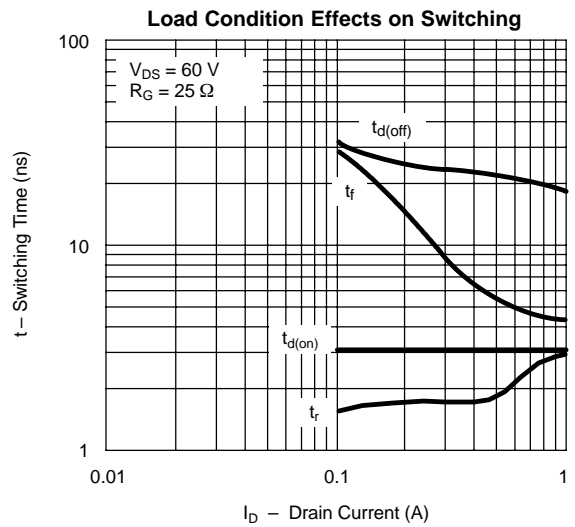
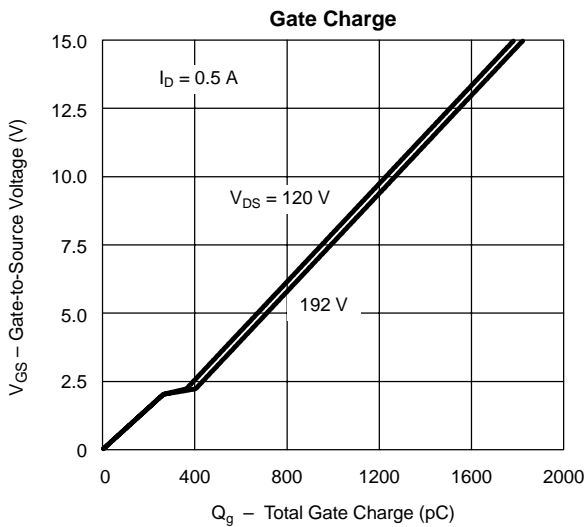
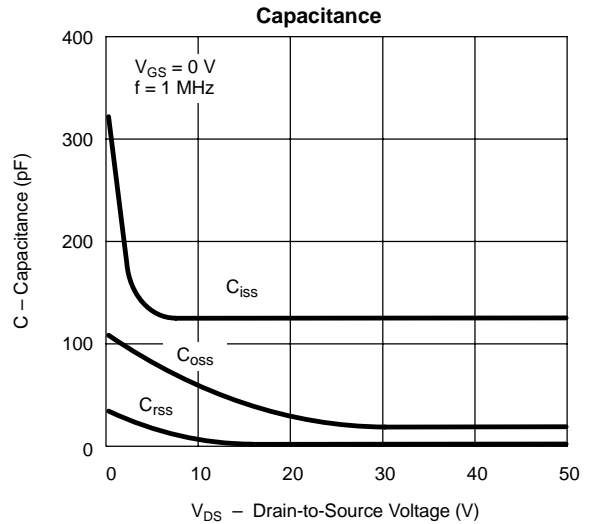
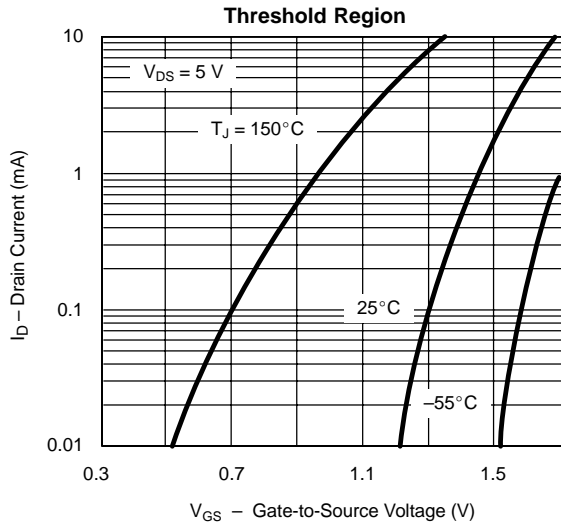



**TYPICAL CHARACTERISTICS ( $T_A = 25^\circ\text{C}$  UNLESS OTHERWISE NOTED)**

