



STP4NC60A - STP4NC60AFP STB4NC60A-1

N-CHANNEL 600V - 1.8Ω - 4.2A TO-220/TO-220FP/I²PAK
PowerMesh™II MOSFET

TYPE	V _{DSS}	R _{DS(on)}	I _D
STP4NC60A	600V	< 2Ω	4.2A
STP4NC60AFP	600V	< 2Ω	4.2A
STB4NC60A-1	600V	< 2Ω	4.2A

- TYPICAL R_{DS(on)} = 1.8Ω
- EXTREMELY HIGH dv/dt CAPABILITY
- 100% AVALANCHE TESTED
- NEW HIGH VOLTAGE BENCHMARK
- GATE CHARGE MINIMIZED

DESCRIPTION

The PowerMESH™II is the evolution of the first generation of MESH OVERLAY™. The layout refinements introduced greatly improve the Ron*area figure of merit while keeping the device at the leading edge for what concerns switching speed, gate charge and ruggedness.

APPLICATIONS

- HIGH CURRENT, HIGH SPEED SWITCHING
- SWITCH MODE POWER SUPPLIES (SMPS)
- DC-AC CONVERTERS FOR WELDING EQUIPMENT AND UNINTERRUPTIBLE POWER SUPPLIES AND MOTOR DRIVERS

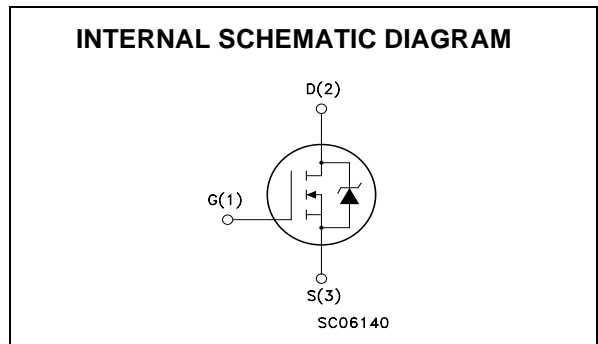
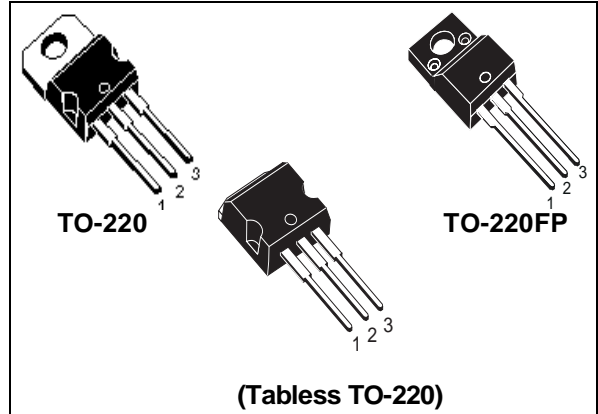

ABSOLUTE MAXIMUM RATINGS

Symbol	Parameter	Value		Unit
		STP(B)4NC60A(-1)	STP4NC60AFP	
V _{DS}	Drain-source Voltage (V _{GS} = 0)	600		V
V _{DGR}	Drain-gate Voltage (R _{GS} = 20 kΩ)	600		V
V _{GS}	Gate- source Voltage	±30		V
I _D	Drain Current (continuous) at T _C = 25°C	4.2	4.2(*)	A
I _D	Drain Current (continuous) at T _C = 100°C	2.6	2.6(*)	A
I _{DM} (●)	Drain Current (pulsed)	16.8	16.8(*)	A
P _{TOT}	Total Dissipation at T _C = 25°C	100	35	W
	Derating Factor	0.8	0.28	W/°C
dv/dt(1)	Peak Diode Recovery voltage slope	3.5	3.5	V/ns
V _{ISO}	Insulation Withstand Voltage (DC)	-	2500	V
T _{stg}	Storage Temperature	-60 to 150		°C
T _j	Max. Operating Junction Temperature			

(●)Pulse width limited by safe operating area

(*)Limited only by maximum Temperature allowed

(1)|I_{SD} ≤ 4.2A, di/dt ≤ 300A/μs, V_{DD} ≤ V_{(BR)DSS}, T_j ≤ T_{JMAX}.
July 2001

STP4NC60A/FP/STB4NC60A-1

THERMAL DATA

		TO-220/1 ² PAK	TO-220FP	
Rthj-case	Thermal Resistance Junction-case Max	1.25	3.57	°C/W
Rthj-amb	Thermal Resistance Junction-ambient Max	62.5		°C/W
T _l	Maximum Lead Temperature For Soldering Purpose	300		°C

AVALANCHE CHARACTERISTICS

Symbol	Parameter	Max Value	Unit
I _{AR}	Avalanche Current, Repetitive or Not-Repetitive (pulse width limited by T _j max)	4.2	A
E _{AS}	Single Pulse Avalanche Energy (starting T _j = 25 °C, I _D = I _{AR} , V _{DD} = 50 V)	250	mJ

ELECTRICAL CHARACTERISTICS (TCASE = 25 °C UNLESS OTHERWISE SPECIFIED)

OFF

Symbol	Parameter	Test Conditions	Min.	Typ.	Max.	Unit
V _{(BR)DSS}	Drain-source Breakdown Voltage	I _D = 250 μA, V _{GS} = 0	600			V
I _{DSS}	Zero Gate Voltage Drain Current (V _{GS} = 0)	V _{DS} = Max Rating V _{DS} = Max Rating, T _C = 125 °C			1 50	μA μA
I _{GSS}	Gate-body Leakage Current (V _{DS} = 0)	V _{GS} = ±30V			±100	nA

ON (1)

Symbol	Parameter	Test Conditions	Min.	Typ.	Max.	Unit
V _{GS(th)}	Gate Threshold Voltage	V _{DS} = V _{GS} , I _D = 250μA	2	3	4	V
R _{DS(on)}	Static Drain-source On Resistance	V _{GS} = 10V, I _D = 1.5 A		1.8	2	Ω

DYNAMIC

Symbol	Parameter	Test Conditions	Min.	Typ.	Max.	Unit
g _{fs} (1)	Forward Transconductance	V _{DS} > I _{D(on)} × R _{DS(on)max} , I _D = 2A		3.7		S
C _{iss}	Input Capacitance	V _{DS} = 25V, f = 1 MHz, V _{GS} = 0		475		pF
C _{oss}	Output Capacitance			72		pF
C _{rss}	Reverse Transfer Capacitance			10		pF

ELECTRICAL CHARACTERISTICS (CONTINUED)

SWITCHING ON

Symbol	Parameter	Test Conditions	Min.	Typ.	Max.	Unit
$t_{d(on)}$	Turn-on Delay Time	$V_{DD} = 300V, I_D = 2A$ $R_G = 4.7\Omega, V_{GS} = 10V$		14		ns
t_r	Rise Time	(see test circuit, Figure 3)		14		ns
Q_g	Total Gate Charge	$V_{DD} = 480V, I_D = 4A,$ $V_{GS} = 10V$		16.5	21.1	nC
Q_{gs}	Gate-Source Charge			2.5		nC
Q_{gd}	Gate-Drain Charge			9		nC

SWITCHING OFF

Symbol	Parameter	Test Conditions	Min.	Typ.	Max.	Unit
$t_{r(Voff)}$	Off-voltage Rise Time	$V_{DD} = 480V, I_D = 4A,$ $R_G = 4.7\Omega, V_{GS} = 10V$		15		ns
t_f	Fall Time	(see test circuit, Figure 5)		19		ns
t_c	Cross-over Time			24		ns

SOURCE DRAIN DIODE

Symbol	Parameter	Test Conditions	Min.	Typ.	Max.	Unit
I_{SD}	Source-drain Current				4.2	A
$I_{SDM(2)}$	Source-drain Current (pulsed)				16.8	A
$V_{SD(1)}$	Forward On Voltage	$I_{SD} = 4.2A, V_{GS} = 0$			1.6	V
t_{rr}	Reverse Recovery Time	$I_{SD} = 4A, di/dt = 100A/\mu s,$ $V_{DD} = 100V, T_j = 150^\circ C$		600		ns
Q_{rr}	Reverse Recovery Charge	(see test circuit, Figure 5)		2.7		μC
I_{RRM}	Reverse Recovery Current			9		A

Note: 1. Pulsed: Pulse duration = 300 μs , duty cycle 1.5 %.
2. Pulse width limited by safe operating area.

Safe Operating Area for TO-220I²PAK

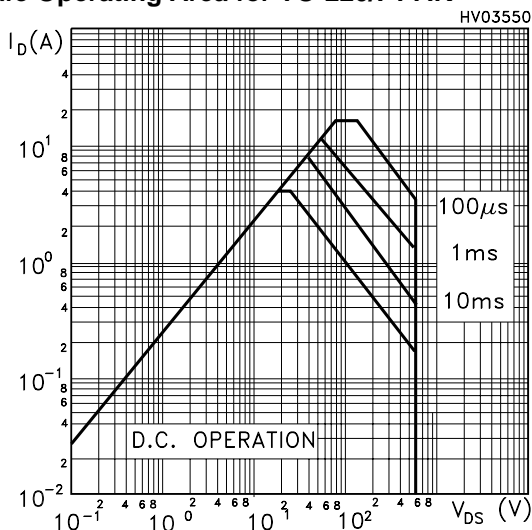

Safe Operating Area for TO-220FP

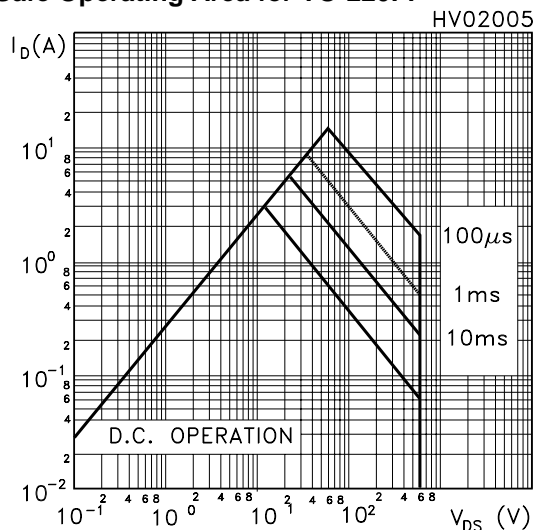

Thermal Impedance for TO-220/1²PAK

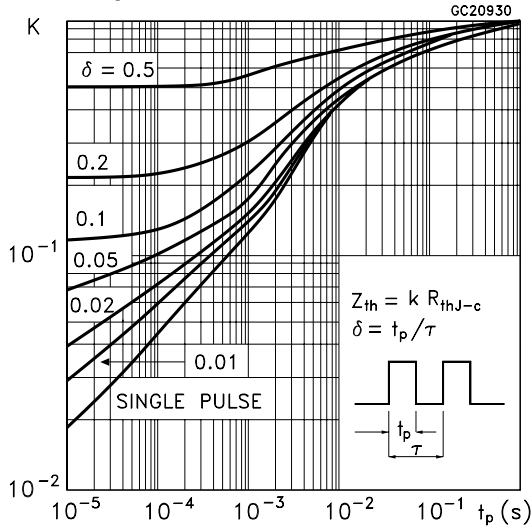

Thermal Impedance for TO-220FP

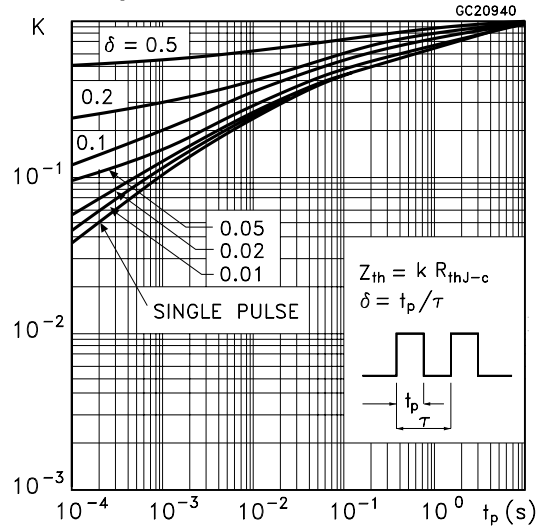

Output Characteristics

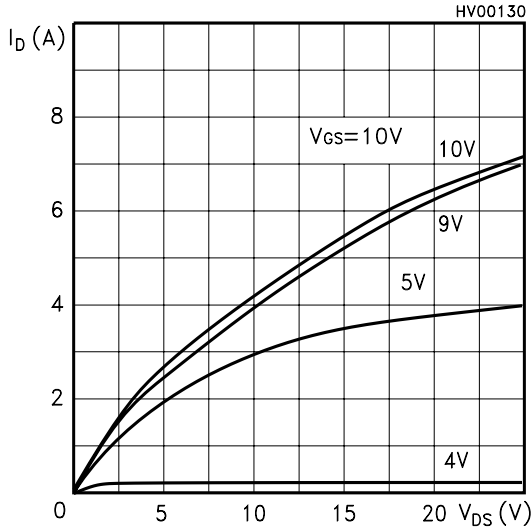

Transfer Characteristics

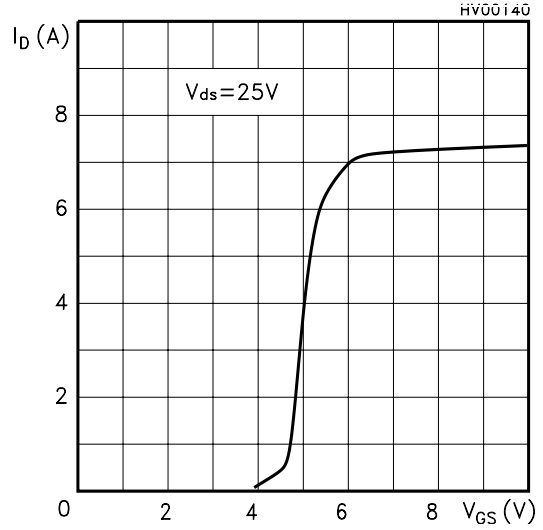

Transconductance

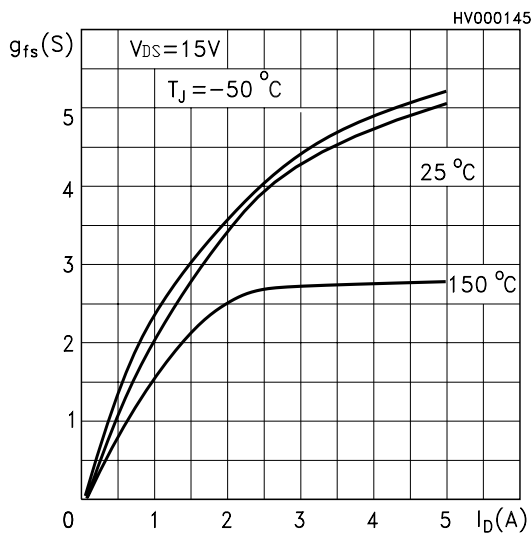

Static Drain-source On Resistance

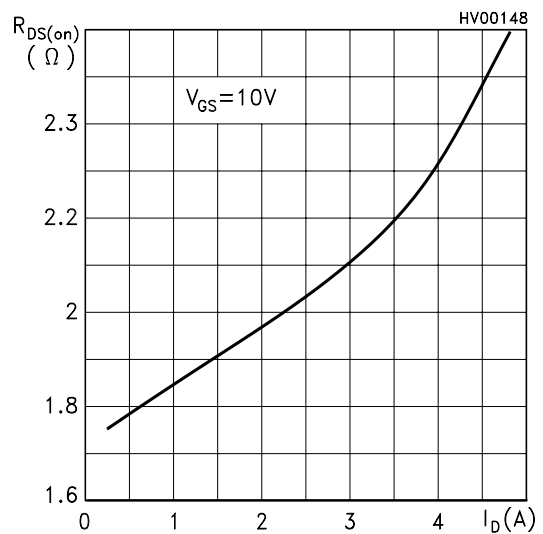

Gate Charge vs Gate-source Voltage

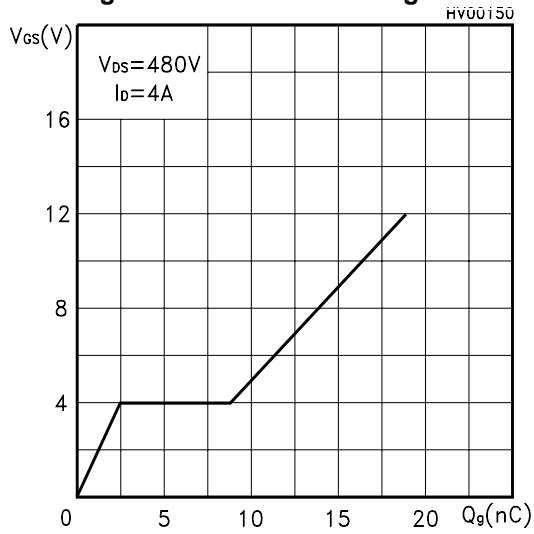

Capacitance Variations

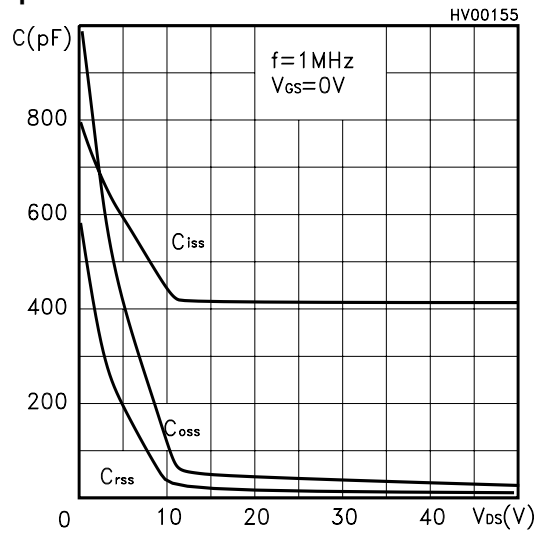

Normalized Gate Threshold Voltage vs Temp.

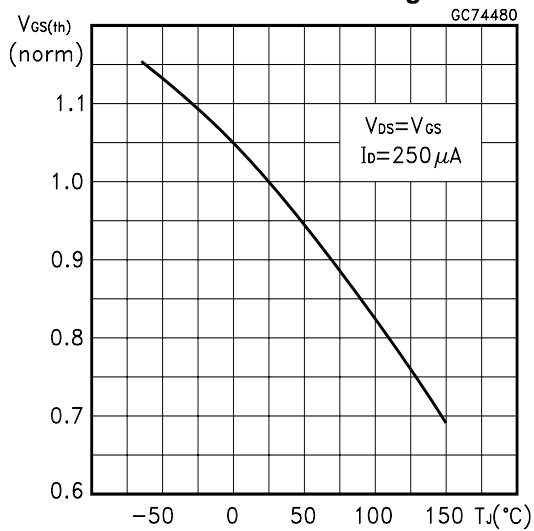

Normalized On Resistance vs Temperature

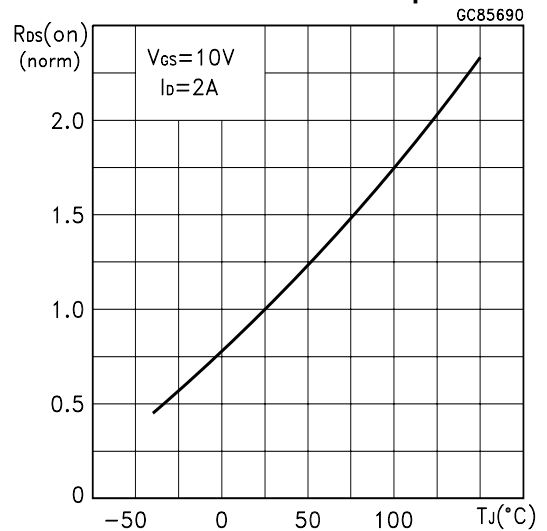

Source-drain Diode Forward Characteristics

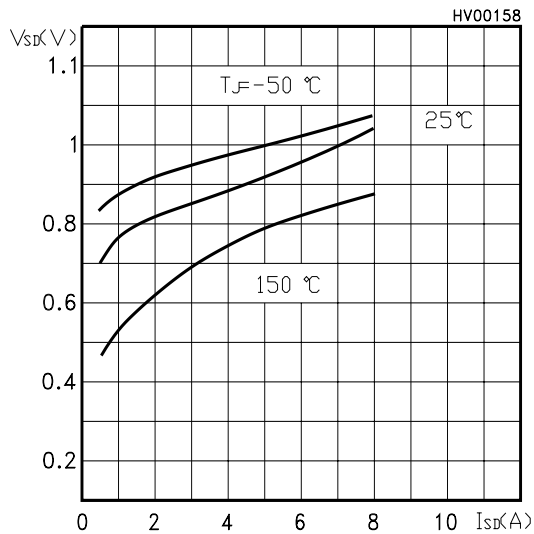

Fig. 1: Unclamped Inductive Load Test Circuit



Fig. 2: Unclamped Inductive Waveform



Fig. 3: Switching Times Test Circuits For Resistive Load



Fig. 4: Gate Charge test Circuit

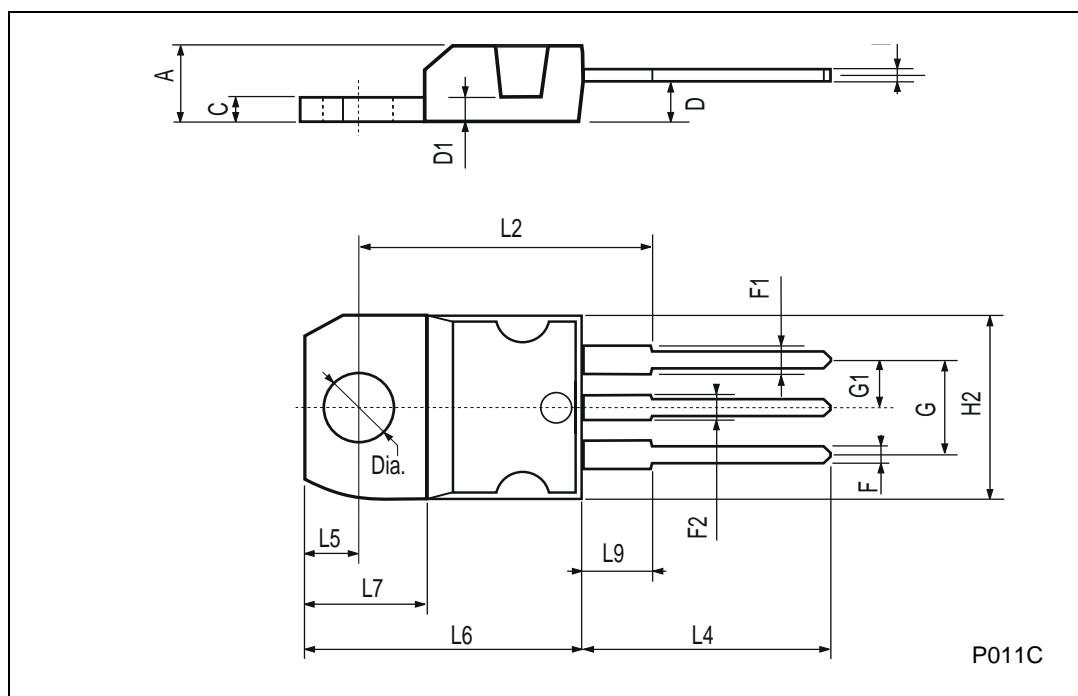

Fig. 5: Test Circuit For Inductive Load Switching And Diode Recovery Times



TO-220 MECHANICAL DATA

DIM.	mm			inch		
	MIN.	TYP.	MAX.	MIN.	TYP.	MAX.
A	4.40		4.60	0.173		0.181
C	1.23		1.32	0.048		0.051
D	2.40		2.72	0.094		0.107
D1		1.27			0.050	
E	0.49		0.70	0.019		0.027
F	0.61		0.88	0.024		0.034
F1	1.14		1.70	0.044		0.067
F2	1.14		1.70	0.044		0.067
G	4.95		5.15	0.194		0.203
G1	2.4		2.7	0.094		0.106
H2	10.0		10.40	0.393		0.409
L2		16.4			0.645	
L4	13.0		14.0	0.511		0.551
L5	2.65		2.95	0.104		0.116
L6	15.25		15.75	0.600		0.620
L7	6.2		6.6	0.244		0.260
L9	3.5		3.93	0.137		0.154
DIA.	3.75		3.85	0.147		0.151



TO-262 (I²PAK) MECHANICAL DATA

DIM.	mm			inch		
	MIN.	TYP.	MAX.	MIN.	TYP.	MAX.
A	4.4		4.6	0.173		0.181
A1	2.49		2.69	0.098		0.106
B	0.7		0.93	0.027		0.036
B2	1.14		1.7	0.044		0.067
C	0.45		0.6	0.017		0.023
C2	1.23		1.36	0.048		0.053
D	8.95		9.35	0.352		0.368
e	2.4		2.7	0.094		0.106
E	10		10.4	0.393		0.409
L	13.1		13.6	0.515		0.531
L1	3.48		3.78	0.137		0.149
L2	1.27		1.4	0.050		0.055

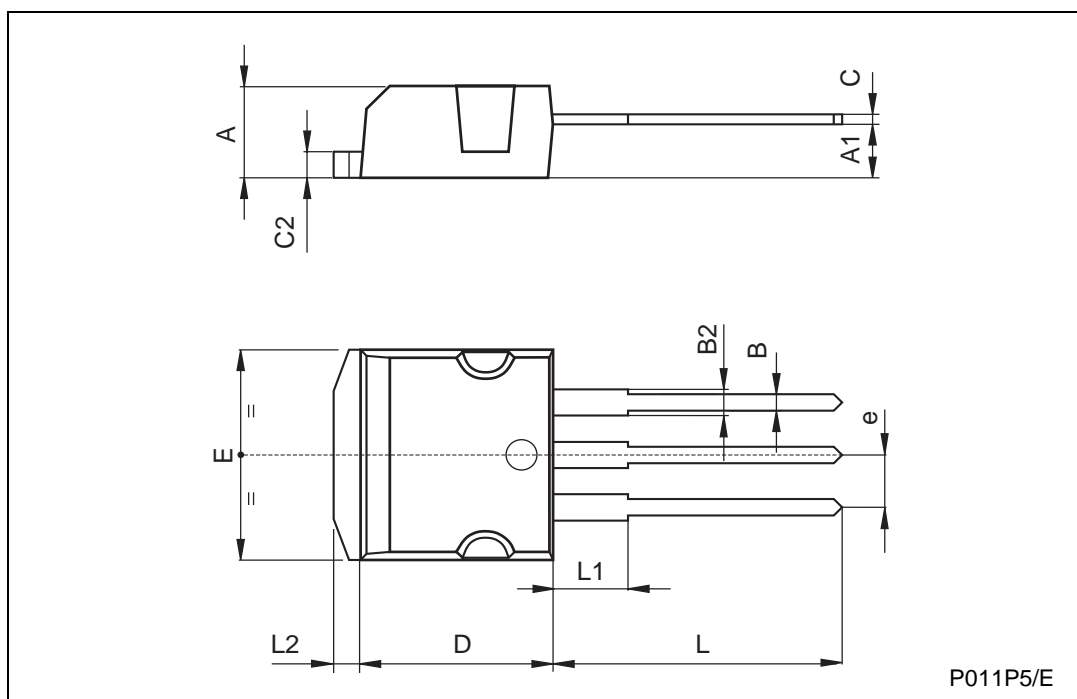

Information furnished is believed to be accurate and reliable. However, STMicroelectronics assumes no responsibility for the consequences of use of such information nor for any infringement of patents or other rights of third parties which may result from its use. No license is granted by implication or otherwise under any patent or patent rights of STMicroelectronics. Specification mentioned in this publication are subject to change without notice. This publication supersedes and replaces all information previously supplied. STMicroelectronics products are not authorized for use as critical components in life support devices or systems without express written approval of STMicroelectronics.

The ST logo is a trademark of STMicroelectronics

© 2000 STMicroelectronics – Printed in Italy – All Rights Reserved
STMicroelectronics GROUP OF COMPANIES

Australia - Brazil - China - Finland - France - Germany - Hong Kong - India - Italy - Japan - Malaysia - Malta - Morocco -
Singapore - Spain - Sweden - Switzerland - United Kingdom - U.S.A.

<http://www.st.com>

Copyright © Each Manufacturing Company.

All Datasheets cannot be modified without permission.

This datasheet has been download from :

www.AllDataSheet.com

100% Free DataSheet Search Site.

Free Download.

No Register.

Fast Search System.

www.AllDataSheet.com