

# TPA0102 1.5-W STEREO AUDIO POWER AMPLIFIER

SLOS166E – MARCH 1997 – REVISED MARCH 2000

- High Power with PC Power Supply
  - 1.5 W/Ch at 5 V
  - 600 mW/Ch at 3 V
- Ultra-Low Distortion
  - < 0.05% THD+N at 1.5 W and 4-Ω Load
- Bridge-Tied Load (BTL) or Single Ended (SE) Modes
- Stereo Input MUX
- Surface-Mount Power Package
  - 24-Pin TSSOP PowerPAD™
- Shutdown Control . . .  $I_{DD} < 10 \mu A$

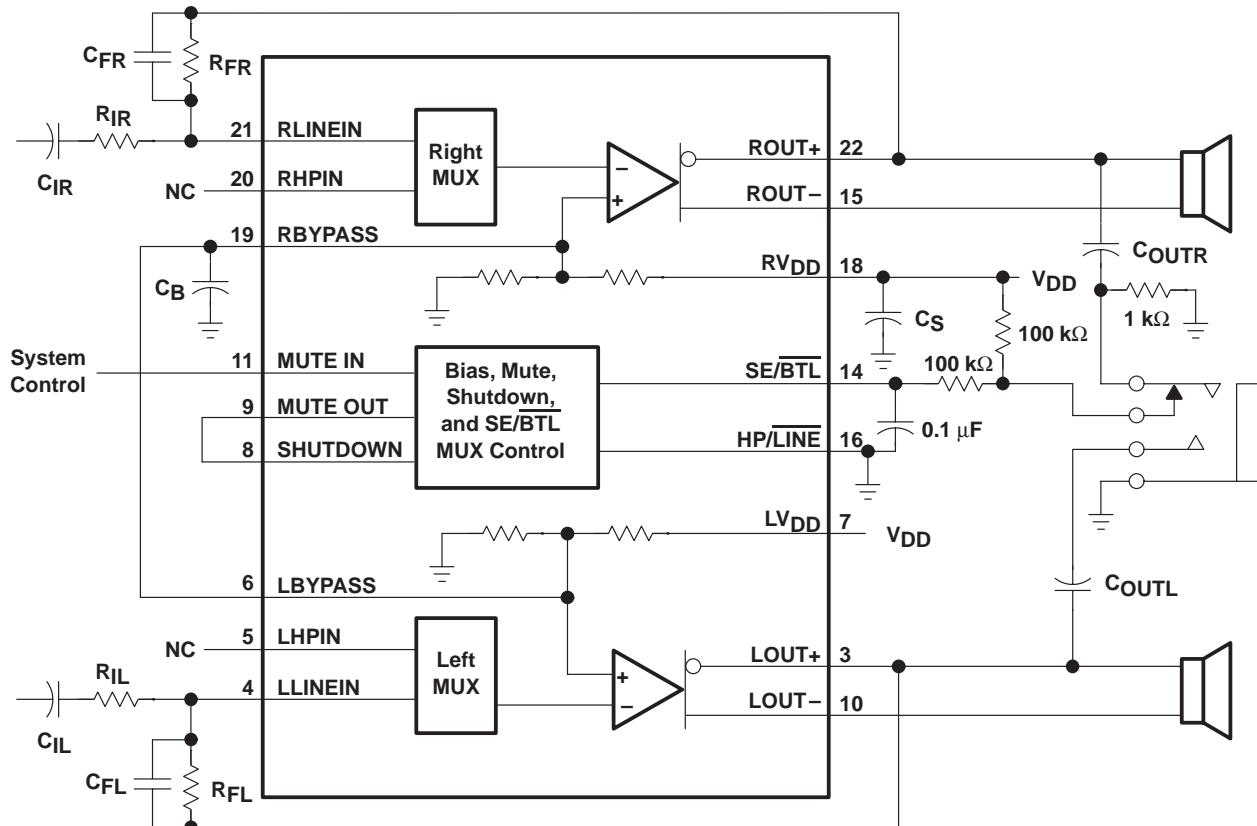
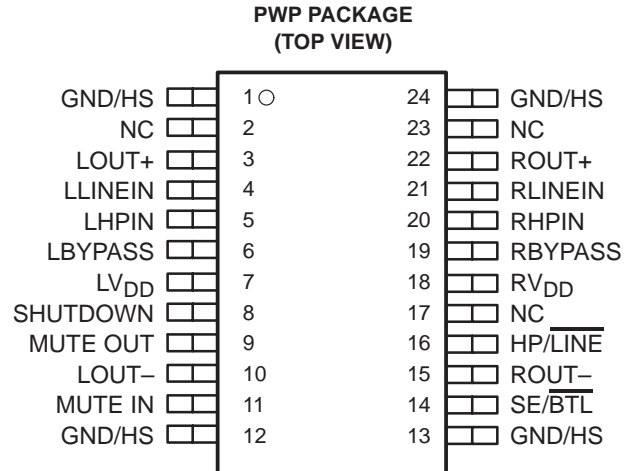

Please be aware that an important notice concerning availability, standard warranty, and use in critical applications of Texas Instruments semiconductor products and disclaimers thereto appears at the end of this data sheet.

PowerPAD is a trademark of Texas Instruments Incorporated.

PRODUCTION DATA information is current as of publication date. Products conform to specifications per the terms of Texas Instruments standard warranty. Production processing does not necessarily include testing of all parameters.

**TEXAS  
INSTRUMENTS**

POST OFFICE BOX 655303 • DALLAS, TEXAS 75265

Copyright © 2000, Texas Instruments Incorporated

# TPA0102

## 1.5-W STEREO AUDIO POWER AMPLIFIER

SLOS166E – MARCH 1997 – REVISED MARCH 2000

---

### description

The TPA0102 is a stereo audio power amplifier in a 24-pin TSSOP thermal package capable of delivering greater than 1.5 W of continuous RMS power per channel into 4-Ω loads. This device functionality provides a very efficient upgrade path from the TPA4860 and TPA4861 mono amplifiers where three separate devices are required for stereo applications: two for speaker drive, plus a third for headphone drive. The TPA0102 simplifies design and frees up board space for other features. Full power distortion levels of less than 0.1% THD+N from a 5-V supply are typical. This provides significant improvement in fidelity for speech and music over the popular TPA4860/61 series. Low-voltage applications are also well served by the TPA0102 providing 600-mW per channel into 4-Ω loads with a 3.3-V supply voltage.

Amplifier gain is externally configured by means of two resistors per input channel and does not require external compensation for settings of 2 to 20 in BTL mode (1 to 10 in SE mode). An internal input MUX allows two sets of stereo inputs to the amplifier. In notebook applications, where internal speakers are driven as BTL and the line (often headphone drive) outputs are required to be SE, the TPA0102 automatically switches into SE mode when the SE/BTL input is activated. Using the TPA0102 to drive line outputs up to 500 mW/channel into external 4 Ω loads is ideal for small non-powered external speakers in portable multimedia systems. The TPA0102 also features a shutdown function for power sensitive applications, holding the supply current below 5 μA. In speakerphone or other monaural applications, the TPA0102 is configured through the power supply terminals to activate only half of the amplifier which reduces supply current by approximately one-half over stereo applications.

The PowerPAD package (PWP) delivers a level of thermal performance that was previously achievable only in TO-220-type packages. Thermal impedances of approximately 35°C/W are readily realized in multilayer PCB applications. This allows the TPA0102 to operate at full power into 4-Ω loads at ambient temperature of up to 55°C. Into 8-Ω loads, the operating ambient temperature increases to 100°C.

AVAILABLE OPTIONS

T <sub>A</sub>	PACKAGE
	TSSOP (PWP)
40°C to 85°C	TPA0102PWP



POST OFFICE BOX 655303 • DALLAS, TEXAS 75265

TPA0102  
1.5-W STEREO AUDIO POWER AMPLIFIER

SLOS166E – MARCH 1997 – REVISED MARCH 2000

**Terminal Functions**

TERMINAL NAME	NO.	I/O	DESCRIPTION
GND/HS	1, 12, 13, 24		Ground connection for circuitry, directly connected to thermal pad
HP/LINE	16	I	Input MUX control input, hold high to select L/RHPIN (5, 20), hold low to select L/RLINEIN (4, 21)
LBYPASS	6		Tap to voltage divider for left channel internal mid-supply bias
LHP IN	5	I	Left channel headphone input, selected when HP/LINE terminal (16) is held high
LLINE IN	4	I	Left channel line input, selected when HP/LINE terminal (16) is held low
LOUT+	3	O	Left channel + output in BTL mode, + output in SE mode
LOUT-	10	O	Left channel – output in BTL mode, high-impedance state in SE mode
LVDD	7	I	Supply voltage input for left channel and for primary bias circuits
MUTE IN	11	I	Mute all amplifiers, hold low for normal operation, hold high to mute
MUTE OUT	9	O	Follows MUTE IN terminal (11), provides buffered output
NC	2, 17, 23		No internal connection
RBYPASS	19		Tap to voltage divider for right channel internal mid-supply bias
RHP IN	20	I	Right channel headphone input, selected when HP/LINE terminal (16) is held high
RLINE IN	21	I	Right channel line input, selected when HP/LINE terminal (16) is held low
ROUT+	22	O	Right channel + output in BTL mode, + output in SE mode
ROUT-	15	O	Right channel – output in BTL mode, high impedance state in SE mode
RVDD	18	I	Supply voltage input for right channel
SE/BTL	14	I	Hold low for BTL mode, hold high for SE mode
SHUTDOWN	8	I	Places entire IC in shutdown mode when held high, $I_{DD} < 1 \mu A$



# TPA0102

## 1.5-W STEREO AUDIO POWER AMPLIFIER

SLOS166E – MARCH 1997 – REVISED MARCH 2000

### absolute maximum ratings over operating free-air temperature range (unless otherwise noted)†

Supply voltage, $V_{DD}$	6 V
Input voltage, $V_I$	-0.3 V to $V_{DD} + 0.3$ V
Continuous total power dissipation	internally limited (see Dissipation Rating Table)
Operating free-air temperature range, $T_A$	-40°C to 85°C
Operating junction temperature range, $T_J$	-40°C to 150°C
Storage temperature range, $T_{stg}$	-65°C to 150°C
Lead temperature 1,6 mm (1/16 inch) from case for 10 seconds	260°C

† Stresses beyond those listed under “absolute maximum ratings” may cause permanent damage to the device. These are stress ratings only, and functional operation of the device at these or any other conditions beyond those indicated under “recommended operating conditions” is not implied. Exposure to absolute-maximum-rated conditions for extended periods may affect device reliability.

DISSIPATION RATING TABLE

PACKAGE	$T_A \leq 25^\circ\text{C}$	DERATING FACTOR	$T_A = 70^\circ\text{C}$	$T_A = 85^\circ\text{C}$
PWP	2.7 W‡	21.8 mW/°C	1.7 W	1.4 W

‡ Please see the Texas Instruments document, *PowerPAD Thermally Enhanced Package Application Report* (literature number SLMA002), for more information on the PowerPAD package. The thermal data was measured on a PCB layout based on the information in the section entitled *Texas Instruments Recommended Board for PowerPAD* on page 33 of the before mentioned document.

### recommended operating conditions

		MIN	NOM	MAX	UNIT
Supply voltage, $V_{DD}$		3	5	5.5	V
Operating free-air temperature, $T_A$	$V_{DD} = 5$ V, 250 mW/ch average power, 4-Ω stereo BTL drive, With proper PCB design	-40		85	°C
	$V_{DD} = 5$ V, 1.5 W/ch average power, 4-Ω stereo BTL drive, With proper PCB design	-40		55	
Common mode input voltage, $V_{ICM}$	$V_{DD} = 5$ V	1.25		4.5	V
	$V_{DD} = 3.3$ V	1.25		2.7	

### dc electrical characteristics, $T_A = 25^\circ\text{C}$

PARAMETER	TEST CONDITIONS		TYP†	MAX	UNIT
$I_{DD}$ Supply current	$V_{DD} = 5$ V	Stereo BTL	19	25	mA
		Stereo SE	9	15	mA
		Mono BTL	9	15	mA
		Mono SE	3	10	mA
	$V_{DD} = 3.3$ V	Stereo BTL	13	20	mA
		Stereo SE	3	10	mA
		Mono BTL	3	10	mA
		Mono SE	3	10	mA
$V_{OO}$ Output offset voltage (measured differentially)	$V_{DD} = 5$ V	Gain = 2, See Note 1	5	25	mV
$I_{DD}(\text{MUTE})$ Supply current in mute mode	$V_{DD} = 5$ V		800		μA
$I_{DD}(\text{SD})$ $I_{DD}$ in shutdown	$V_{DD} = 5$ V		5	15	μA

NOTE 1: At  $3\text{ V} < V_{DD} < 5\text{ V}$  the dc output voltage is approximately  $V_{DD}/2$ .



# TPA0102

## 1.5-W STEREO AUDIO POWER AMPLIFIER

SLOS166E – MARCH 1997 – REVISED MARCH 2000

### ac operating characteristics, $V_{DD} = 5\text{ V}$ , $T_A = 25^\circ\text{C}$ , $R_L = 4\ \Omega$

PARAMETER		TEST CONDITIONS	MIN	TYP	MAX	UNIT
$P_O$	Output power (each channel) see Note 2	THD = 0.2%, BTL		1.25		W
		THD = 1%, BTL		1.5		
		THD = 0.2%, SE		500		mW
		THD = 1%, SE		600		
THD+N	Total harmonic distortion plus noise	$P_O = 1\text{ W}$ , $f = 20\text{ to }20\text{ kHz}$		200		m%
$B_{OM}$	Maximum output power bandwidth	$G = 10$ , THD < 5 %		>20		kHz
	Phase margin	BTL		72°		
		Open Load		71°		
		SE		52°		
	Power supply ripple rejection	$f = 1\text{ kHz}$		75		dB
		$f = 20 - 20\text{ kHz}$ ,		60		
	Mute attenuation			85		dB
	Channel-to-channel output separation	$f = 1\text{ kHz}$		65		dB
	Line/HP input separation			100		dB
	BTL attenuation in SE mode			100		dB
$Z_I$	Input impedance			2		M $\Omega$
	Signal-to-noise ratio	$P_O = 500\text{ mW}$ , BTL		95		dB
$V_n$	Output noise voltage			25		$\mu\text{V(rms)}$

NOTE 2: Output power is measured at the output terminals of the IC at 1 kHz.

### ac operating characteristics, $V_{DD} = 3.3\text{ V}$ , $T_A = 25^\circ\text{C}$ , $R_L = 4\ \Omega$

PARAMETER		TEST CONDITIONS	MIN	TYP	MAX	UNIT
$P_O$	Output power (each channel) see Note 2	THD = 0.2% BTL		600		mW
		THD = 1% BTL		750		
		THD = 0.2%, SE		200		
		THD = 1%, SE		250		
THD+N	Total harmonic distortion plus noise	$P_O = 600\text{ mW}$ , $f = 20\text{ to }20\text{ kHz}$		250		m%
$B_{OM}$	Maximum output power bandwidth	$G = 10$ , THD < 5 %		>20		kHz
	Phase margin	BTL		92°		
		Open Load		70°		
		SE		57°		
	Power supply ripple rejection	$f = 1\text{ kHz}$		70		dB
		$f = 20 - 20\text{ kHz}$		55		
	Mute attenuation			85		dB
	Channel-to-channel output separation	$f = 1\text{ kHz}$		65		dB
	Line/HP input separation			100		dB
	BTL attenuation in SE mode			100		dB
$Z_I$	Input impedance			2		M $\Omega$
	Signal-to-noise ratio	$P_O = 500\text{ mW}$ , BTL		95		dB
$V_n$	Output noise voltage			25		$\mu\text{V(rms)}$

NOTE 2: Output power is measured at the output terminals of the IC at 1 kHz.



# TPA0102 1.5-W STEREO AUDIO POWER AMPLIFIER

SLOS166E – MARCH 1997 – REVISED MARCH 2000

## PARAMETER MEASUREMENT INFORMATION

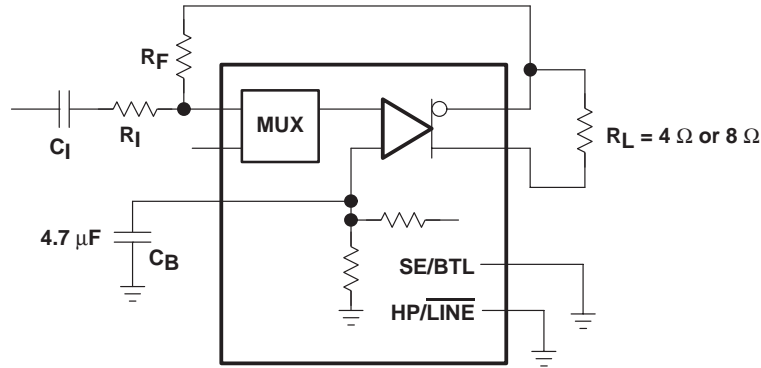

Figure 1. BTL Test Circuit

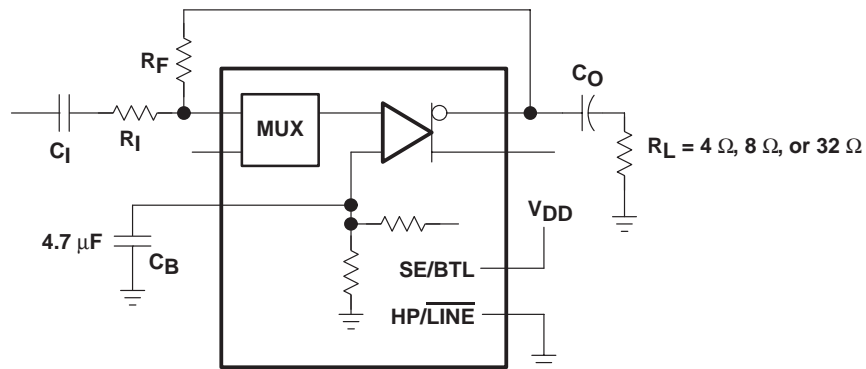

Figure 2. SE Test Circuit

TYPICAL CHARACTERISTICS

Table of Graphs

		FIGURE
THD + N	Total harmonic distortion plus noise	
	vs Frequency	4, 5, 7, 8, 11, 12, 14, 15, 17, 18, 20, 21, 23, 24, 26, 27, 29, 30, 32, 33
	vs Output power	3, 6, 9, 10, 13, 16, 19, 22, 25, 28, 31, 34
$V_n$	Output noise voltage	vs Frequency
	Supply ripple rejection ratio	vs Frequency
	Crosstalk	vs Frequency
	Open loop response	vs Frequency
	Closed loop response	vs Frequency
$I_{DD}$	Supply current	vs Supply voltage
$P_O$	Output power	vs Supply voltage
		vs Load resistance
$P_D$	Power dissipation	vs Output power

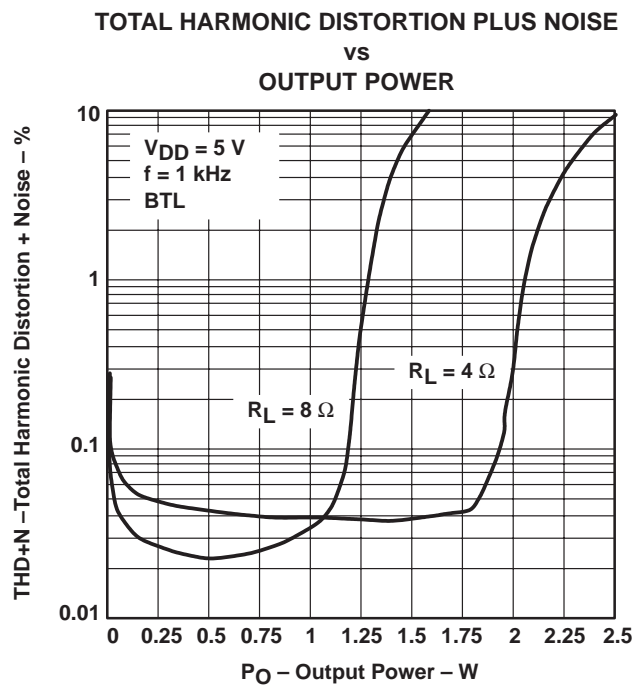

Figure 3

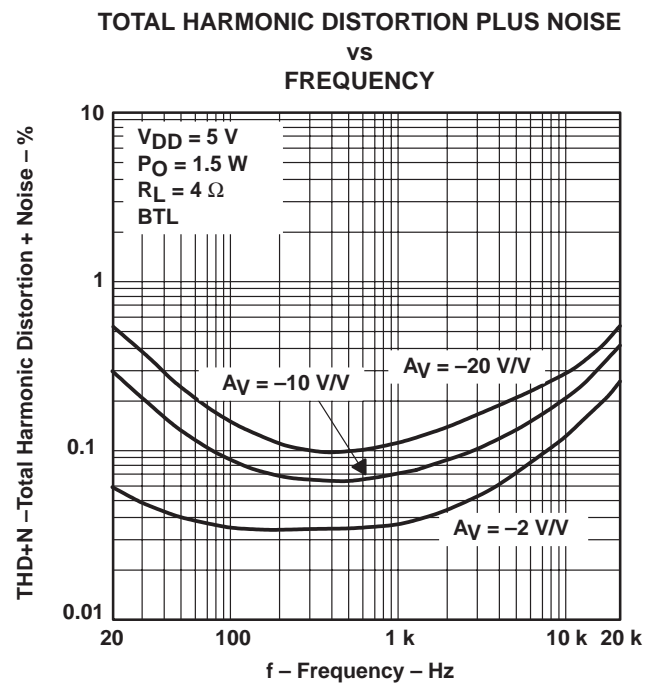

Figure 4

# TPA0102

## 1.5-W STEREO AUDIO POWER AMPLIFIER

SLOS166E – MARCH 1997 – REVISED MARCH 2000

### TYPICAL CHARACTERISTICS

TOTAL HARMONIC DISTORTION PLUS NOISE  
vs  
FREQUENCY

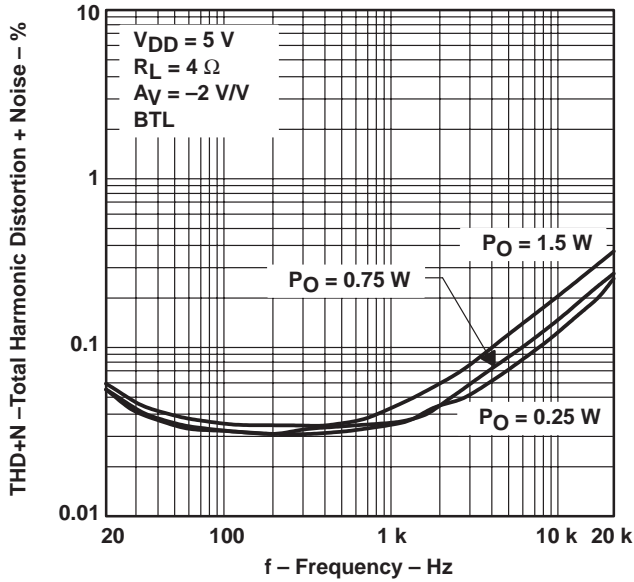

Figure 5

TOTAL HARMONIC DISTORTION PLUS NOISE  
vs  
OUTPUT POWER

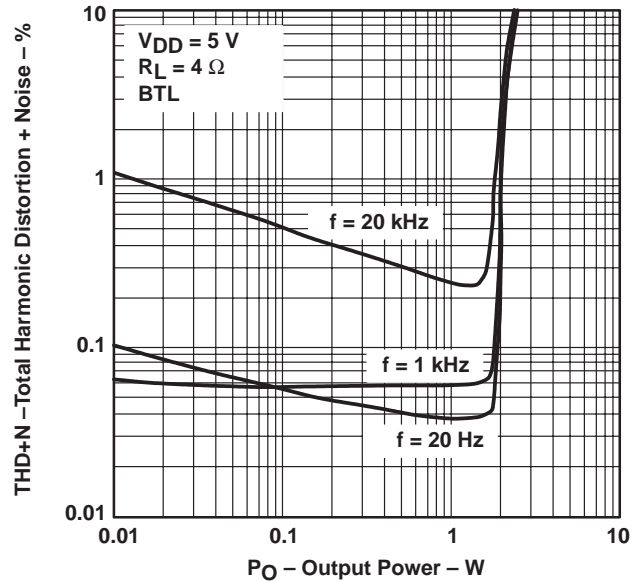

Figure 6

TOTAL HARMONIC DISTORTION PLUS NOISE  
vs  
FREQUENCY

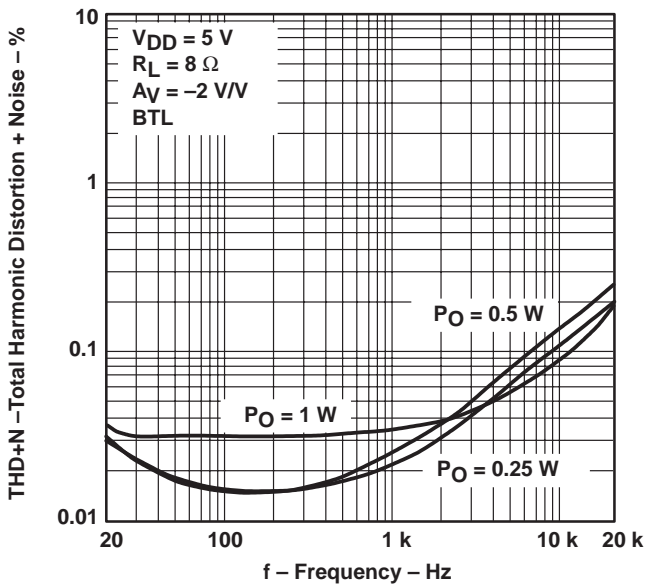

Figure 7

TOTAL HARMONIC DISTORTION PLUS NOISE  
vs  
FREQUENCY

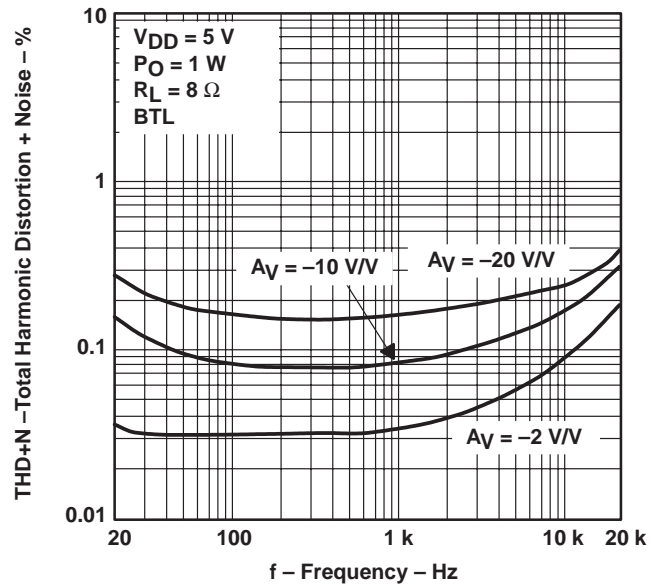

Figure 8





TYPICAL CHARACTERISTICS

TOTAL HARMONIC DISTORTION PLUS NOISE  
vs  
OUTPUT POWER

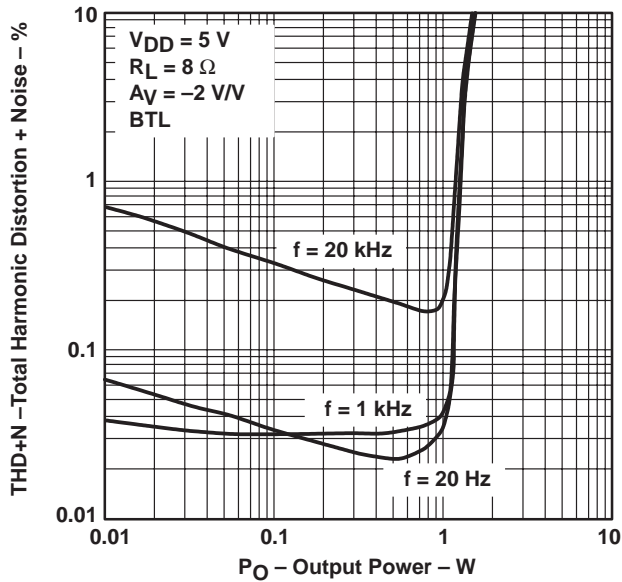

Figure 9

TOTAL HARMONIC DISTORTION PLUS NOISE  
vs  
OUTPUT POWER

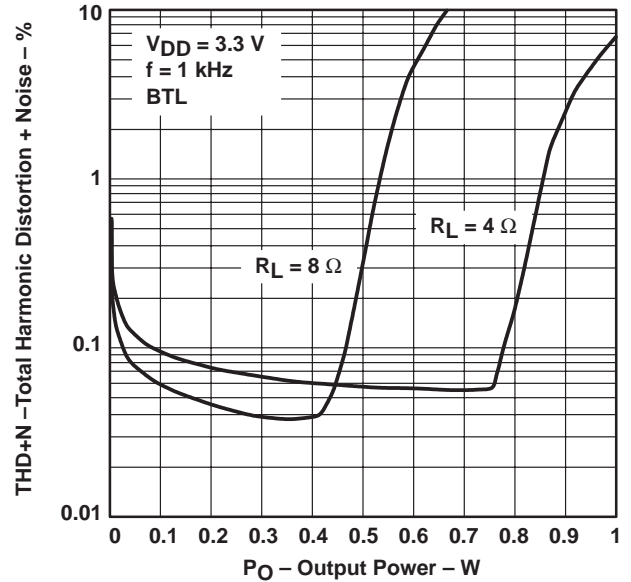

Figure 10

TOTAL HARMONIC DISTORTION PLUS NOISE  
vs  
FREQUENCY

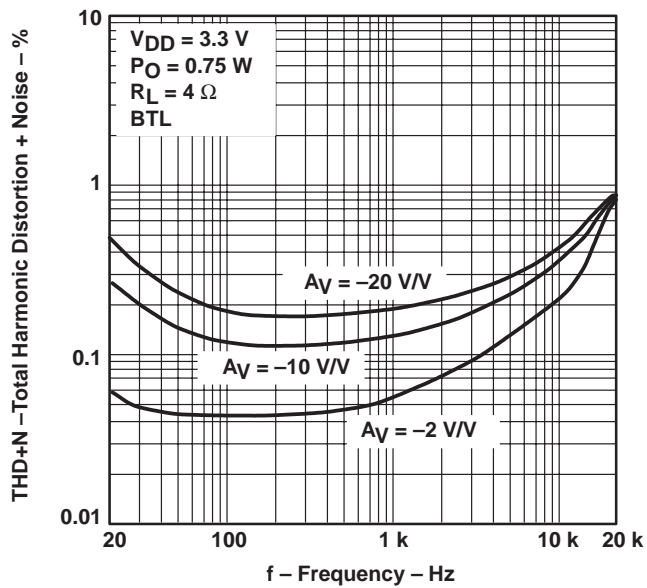

Figure 11

TOTAL HARMONIC DISTORTION PLUS NOISE  
vs  
FREQUENCY

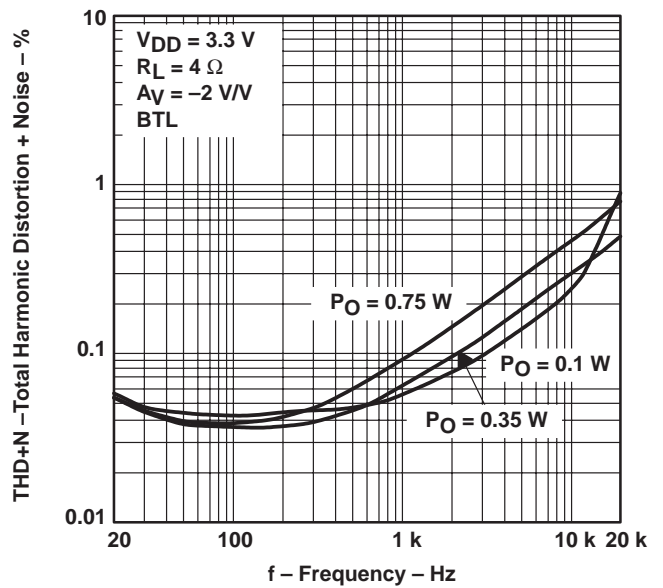

Figure 12

# TPA0102

## 1.5-W STEREO AUDIO POWER AMPLIFIER

SLOS166E – MARCH 1997 – REVISED MARCH 2000

### TYPICAL CHARACTERISTICS

TOTAL HARMONIC DISTORTION PLUS NOISE  
vs  
OUTPUT POWER

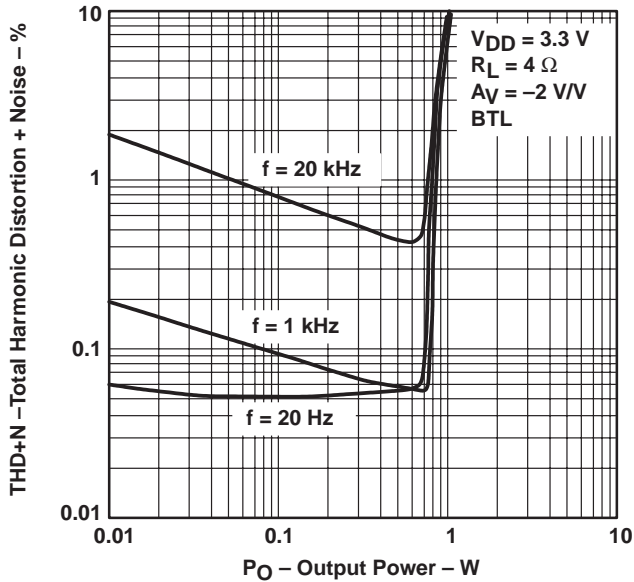

Figure 13

TOTAL HARMONIC DISTORTION PLUS NOISE  
vs  
FREQUENCY

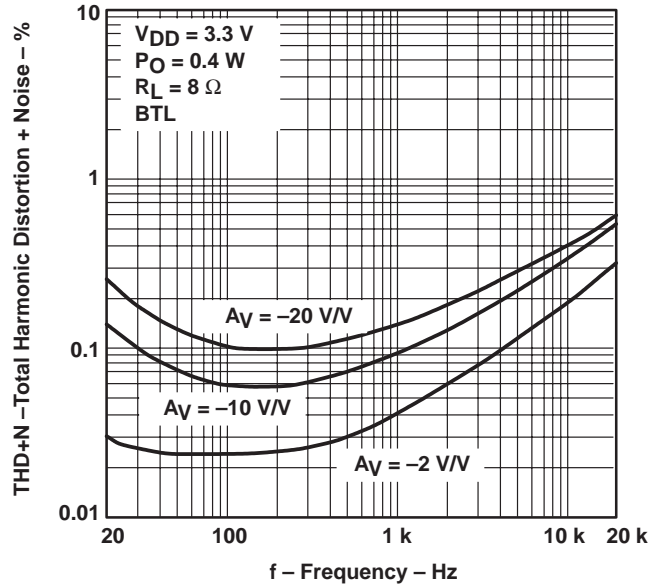

Figure 14

TOTAL HARMONIC DISTORTION PLUS NOISE  
vs  
FREQUENCY

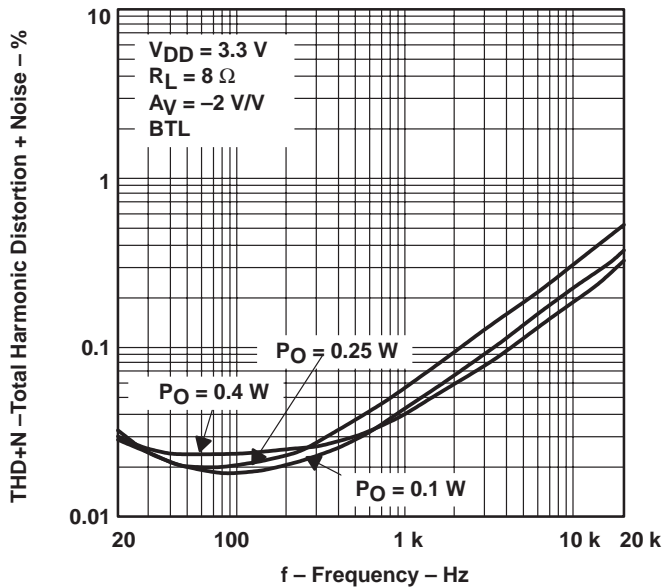

Figure 15

TOTAL HARMONIC DISTORTION PLUS NOISE  
vs  
OUTPUT POWER

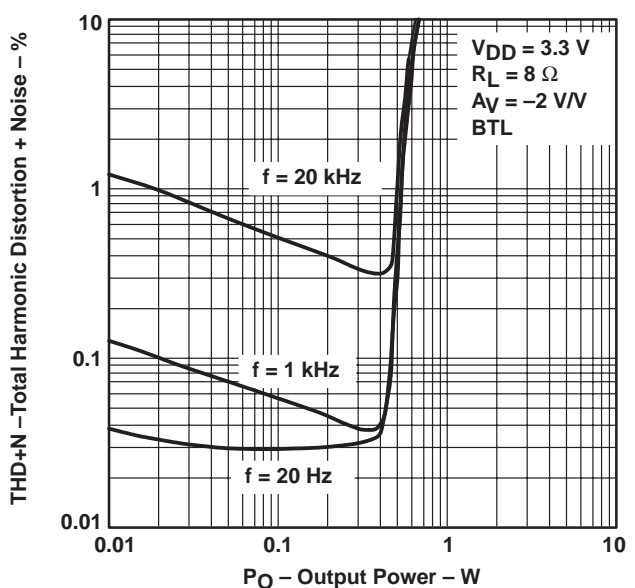

Figure 16



TYPICAL CHARACTERISTICS

TOTAL HARMONIC DISTORTION PLUS NOISE  
vs  
FREQUENCY

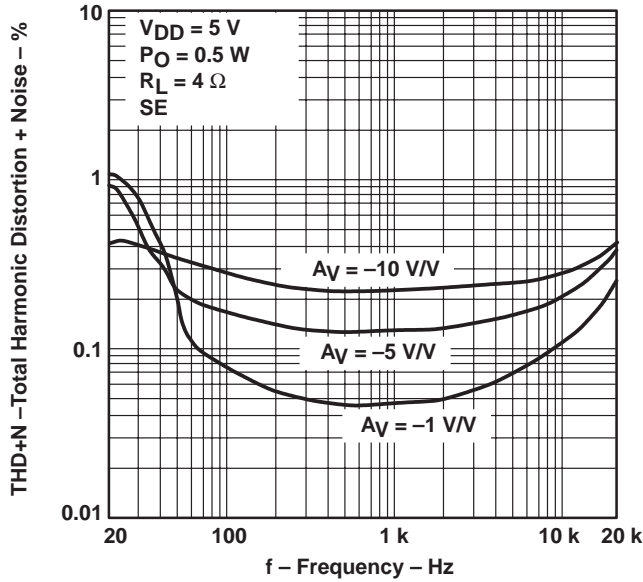

Figure 17

TOTAL HARMONIC DISTORTION PLUS NOISE  
vs  
FREQUENCY

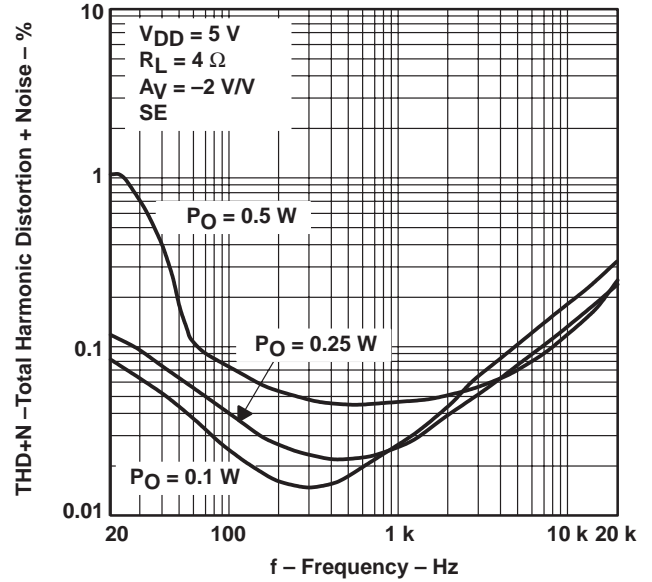

Figure 18

TOTAL HARMONIC DISTORTION PLUS NOISE  
vs  
OUTPUT POWER

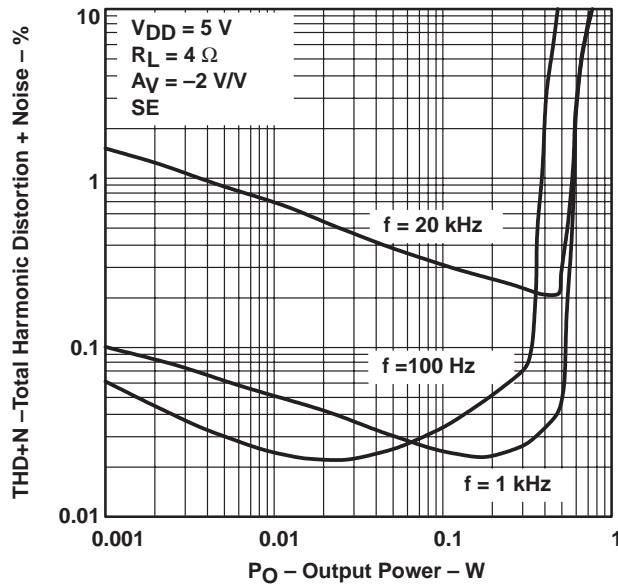

Figure 19

TOTAL HARMONIC DISTORTION PLUS NOISE  
vs  
FREQUENCY

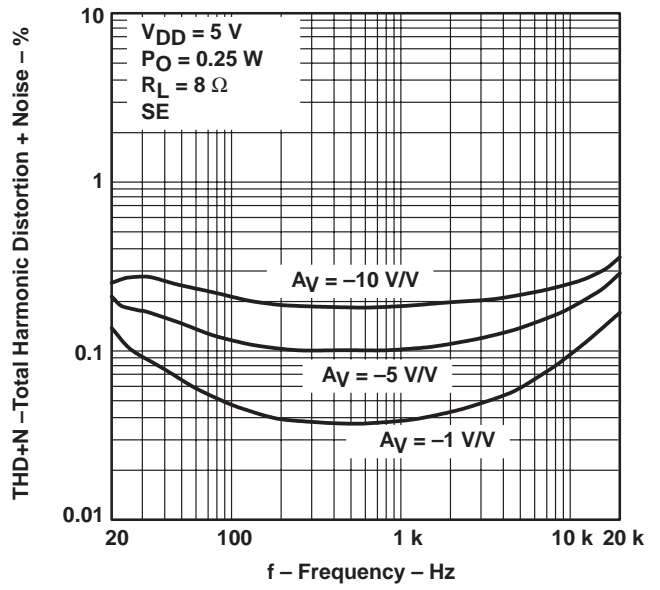

Figure 20

# TPA0102

## 1.5-W STEREO AUDIO POWER AMPLIFIER

SLOS166E – MARCH 1997 – REVISED MARCH 2000

### TYPICAL CHARACTERISTICS

TOTAL HARMONIC DISTORTION PLUS NOISE  
vs  
FREQUENCY

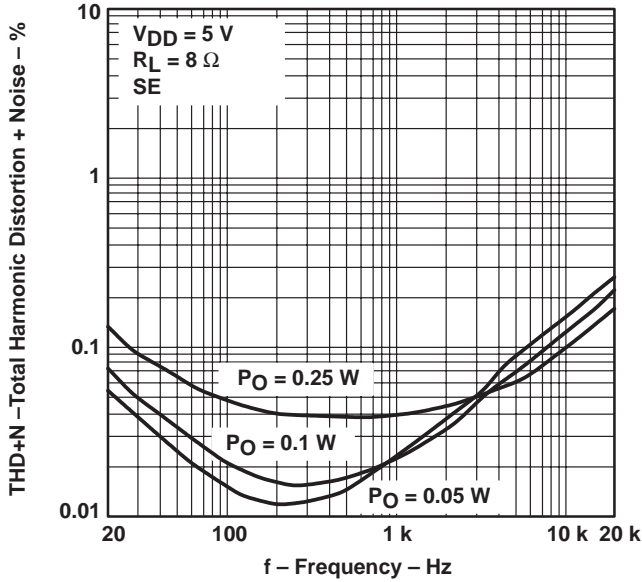

Figure 21

TOTAL HARMONIC DISTORTION PLUS NOISE  
vs  
OUTPUT POWER

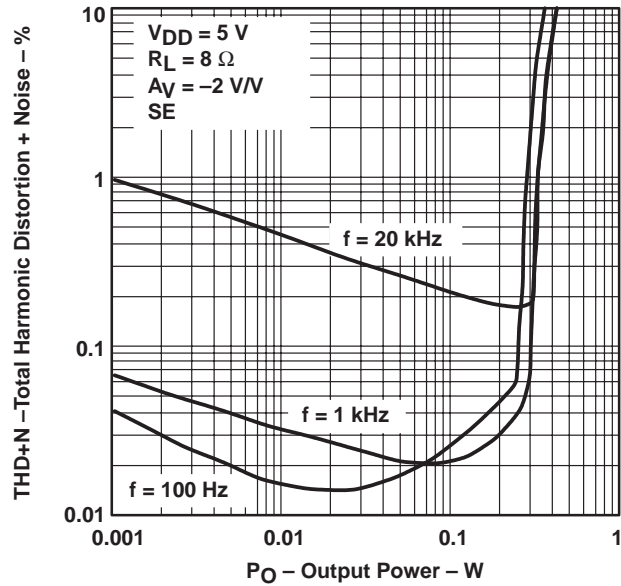

Figure 22

TOTAL HARMONIC DISTORTION PLUS NOISE  
vs  
FREQUENCY

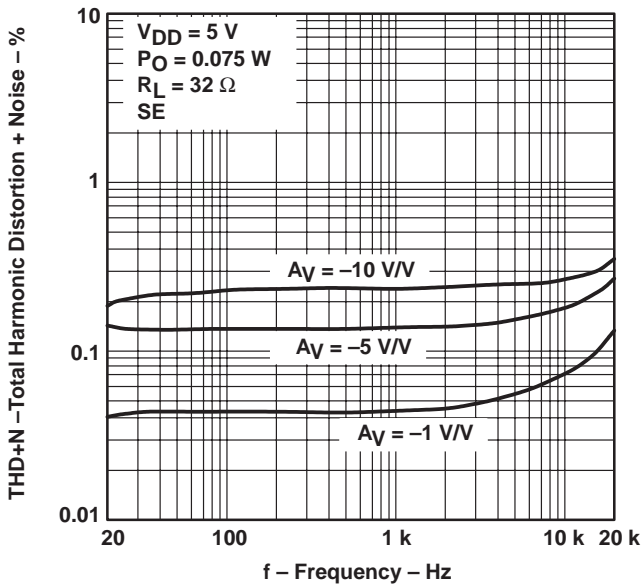

Figure 23

TOTAL HARMONIC DISTORTION PLUS NOISE  
vs  
FREQUENCY

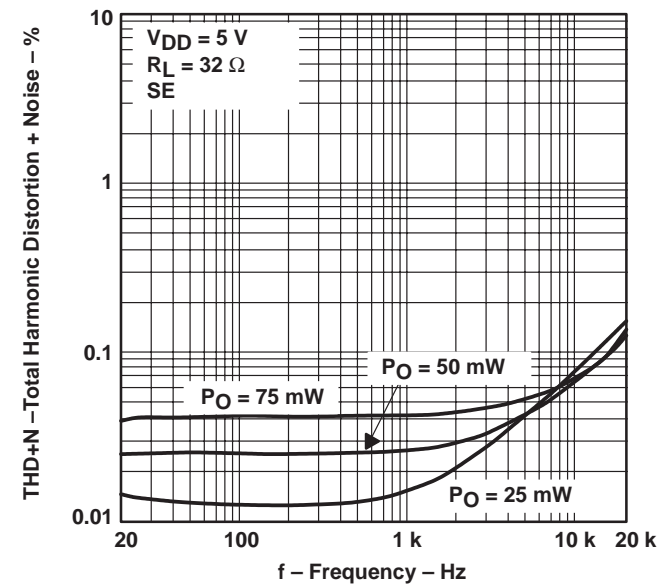

Figure 24



TYPICAL CHARACTERISTICS

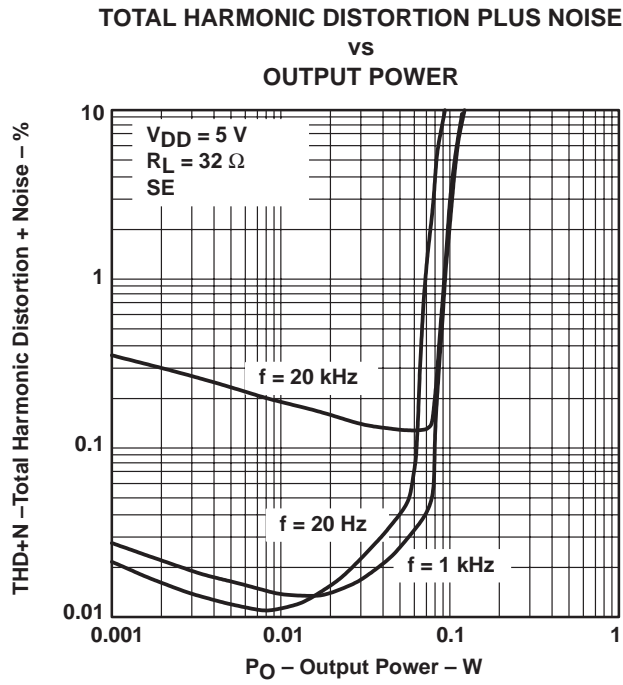

Figure 25

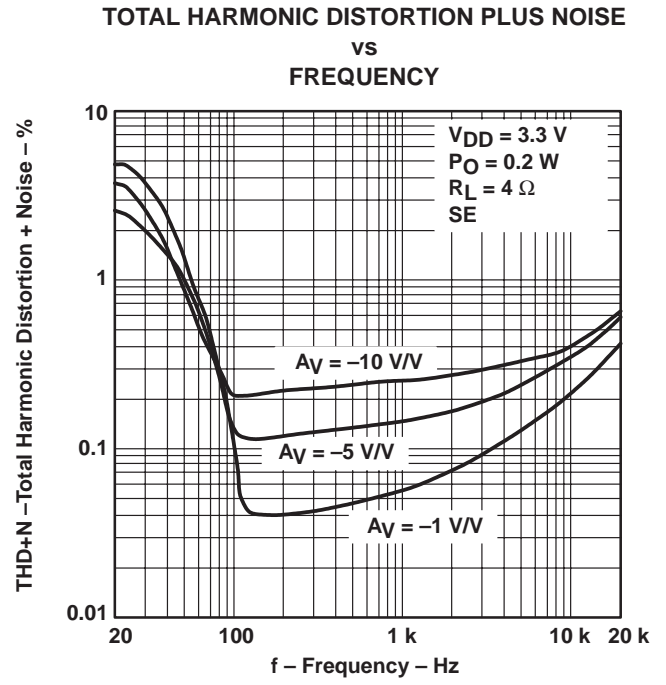

Figure 26

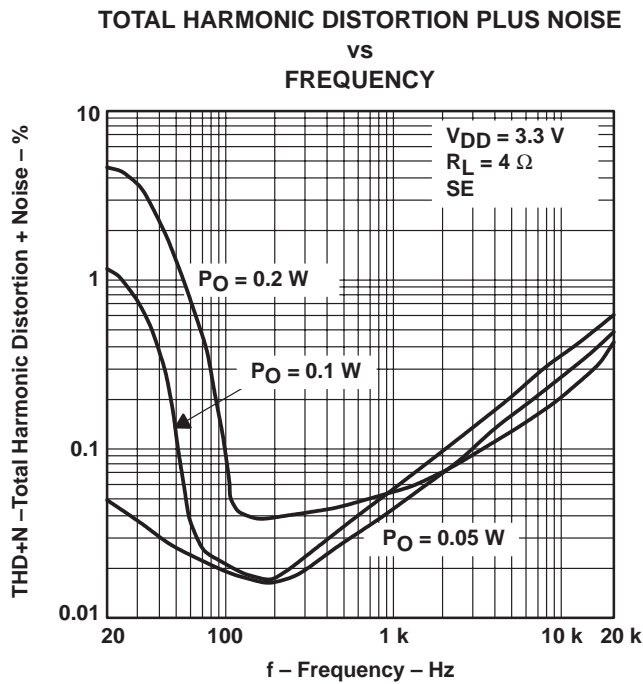

Figure 27

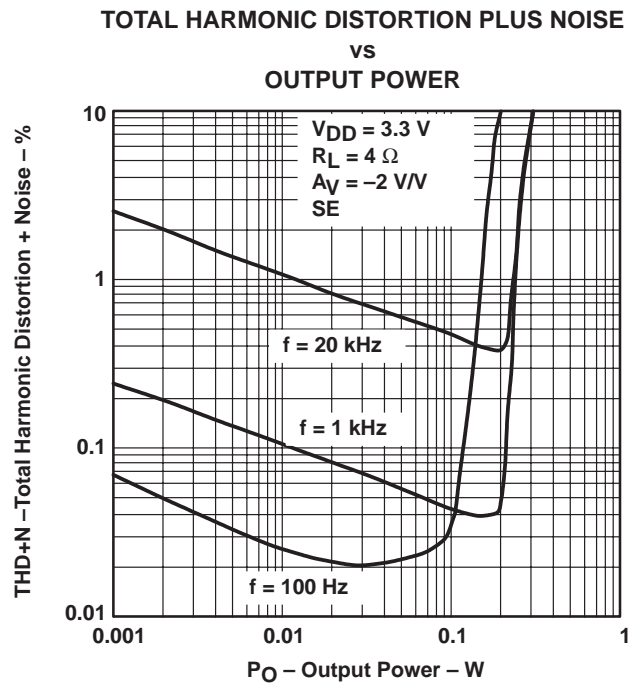

Figure 28

# TPA0102

## 1.5-W STEREO AUDIO POWER AMPLIFIER

SLOS166E – MARCH 1997 – REVISED MARCH 2000

### TYPICAL CHARACTERISTICS

TOTAL HARMONIC DISTORTION PLUS NOISE  
vs  
FREQUENCY

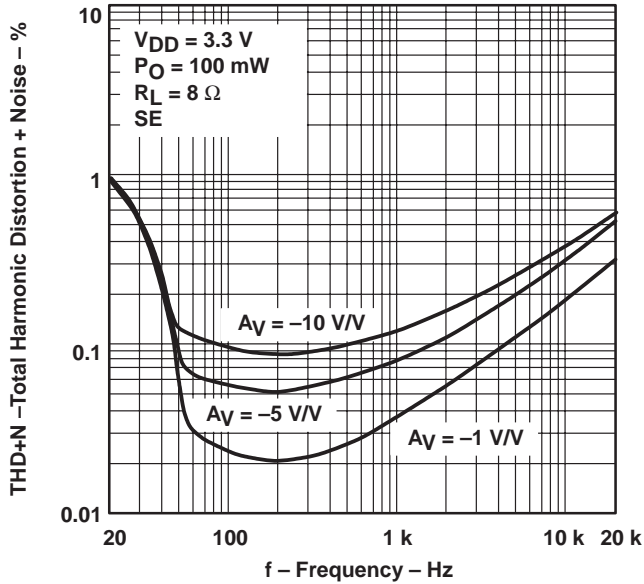

Figure 29

TOTAL HARMONIC DISTORTION PLUS NOISE  
vs  
FREQUENCY

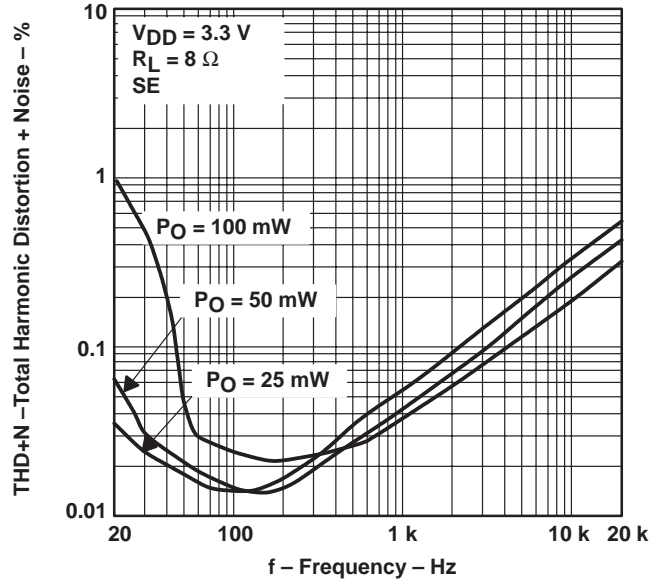

Figure 30

TOTAL HARMONIC DISTORTION PLUS NOISE  
vs  
OUTPUT POWER

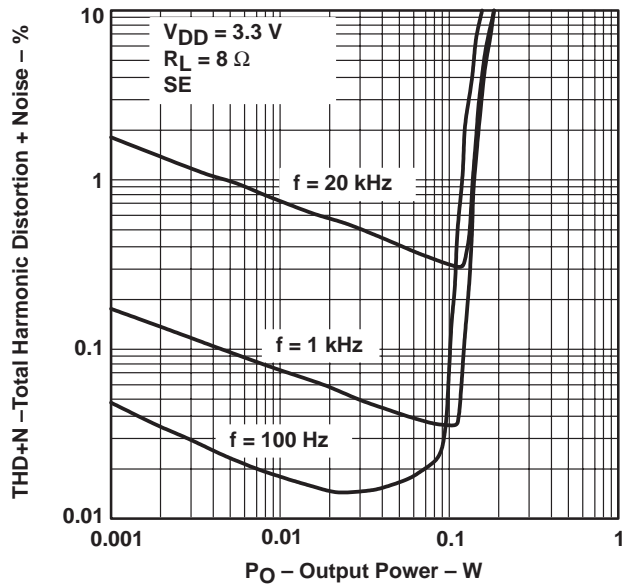

Figure 31

TOTAL HARMONIC DISTORTION PLUS NOISE  
vs  
FREQUENCY

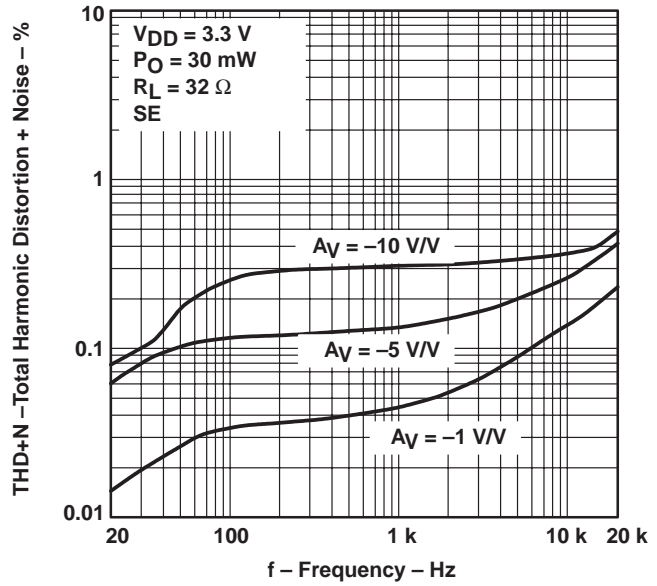

Figure 32



TYPICAL CHARACTERISTICS

TOTAL HARMONIC DISTORTION PLUS NOISE  
vs  
FREQUENCY

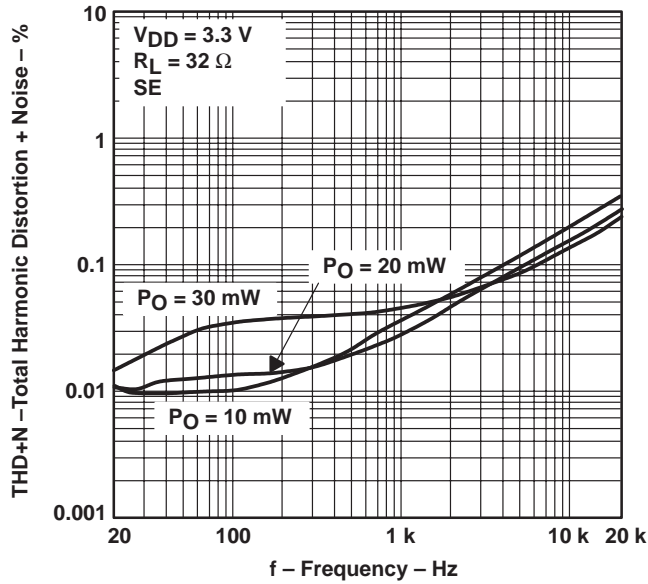

Figure 33

TOTAL HARMONIC DISTORTION PLUS NOISE  
vs  
OUTPUT POWER

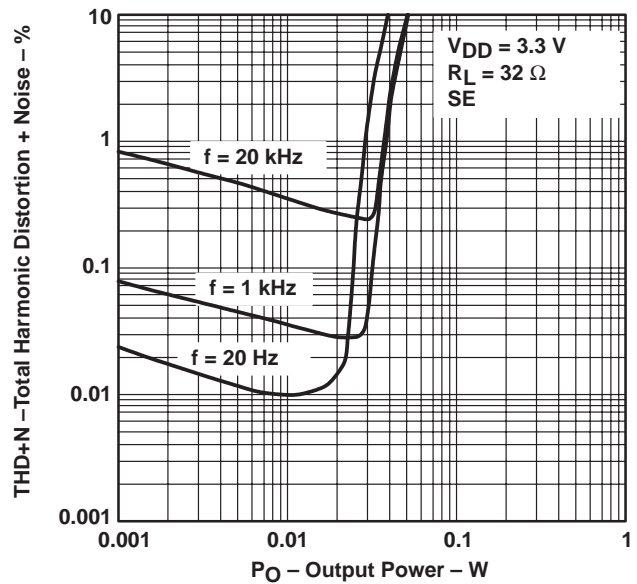

Figure 34

OUTPUT NOISE VOLTAGE  
vs  
FREQUENCY

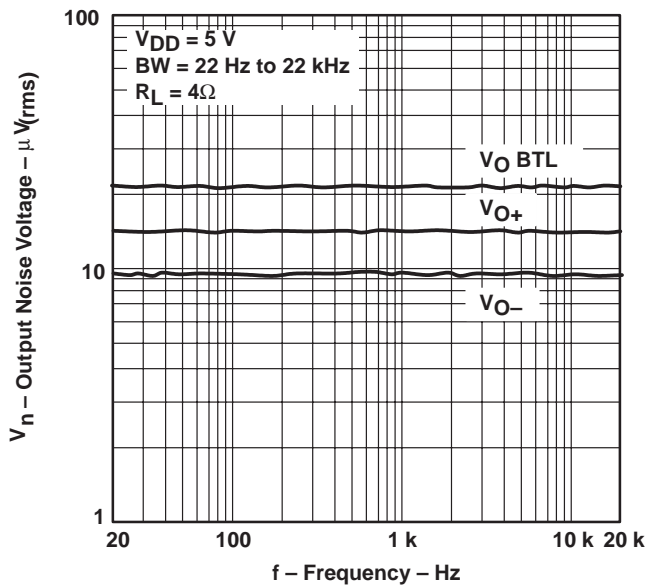

Figure 35

OUTPUT NOISE VOLTAGE  
vs  
FREQUENCY

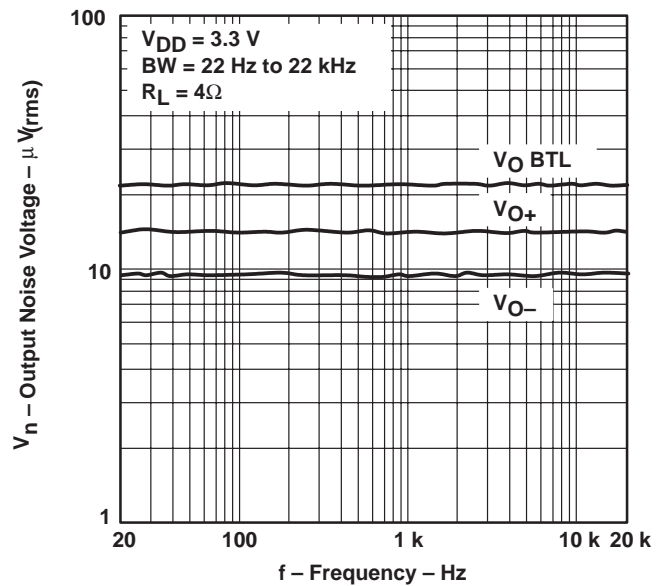

Figure 36

# TPA0102 1.5-W STEREO AUDIO POWER AMPLIFIER

SLOS166E – MARCH 1997 – REVISED MARCH 2000

## TYPICAL CHARACTERISTICS

**SUPPLY RIPPLE REJECTION RATIO  
vs  
FREQUENCY**

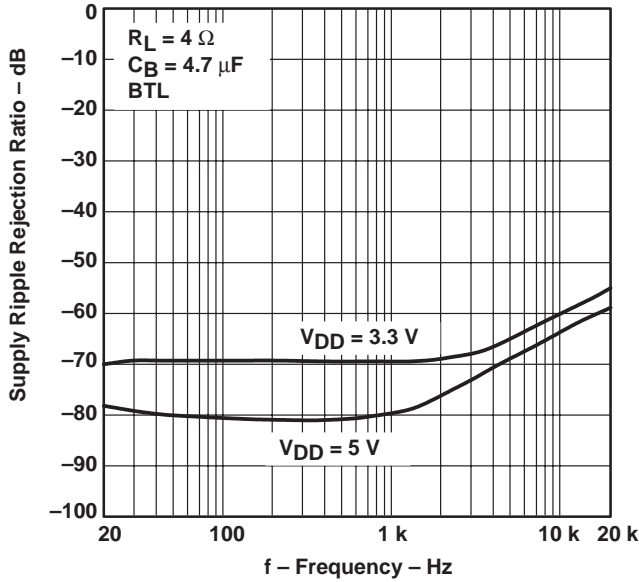

Figure 37

**SUPPLY RIPPLE REJECTION RATIO  
vs  
FREQUENCY**

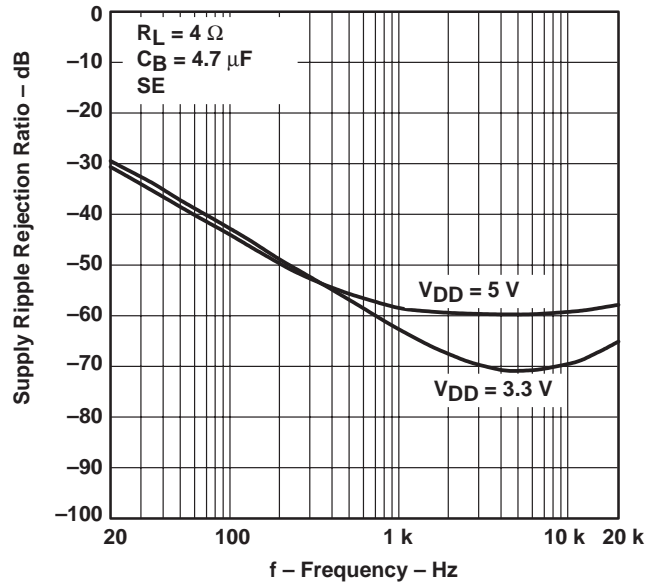

Figure 38

**CROSSTALK  
vs  
FREQUENCY**

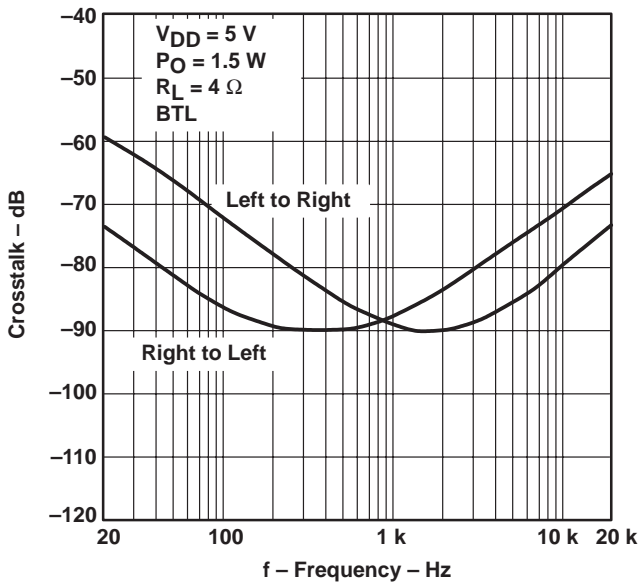

Figure 39

**CROSSTALK  
vs  
FREQUENCY**

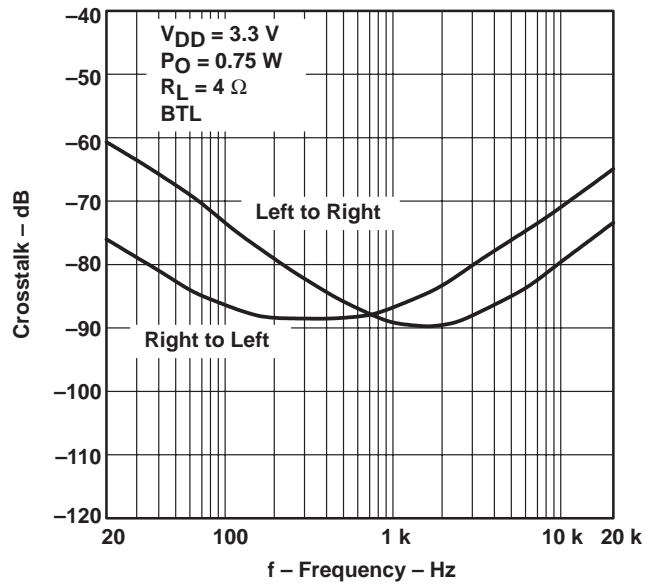

Figure 40



TYPICAL CHARACTERISTICS

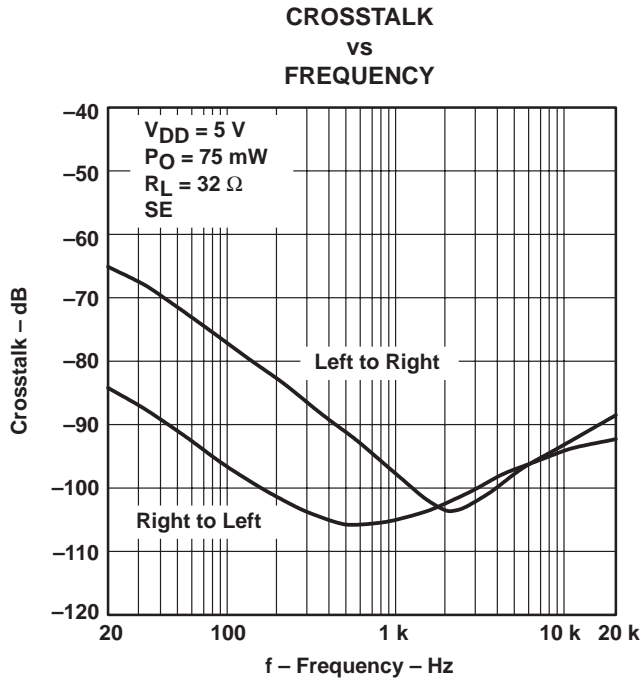

Figure 41

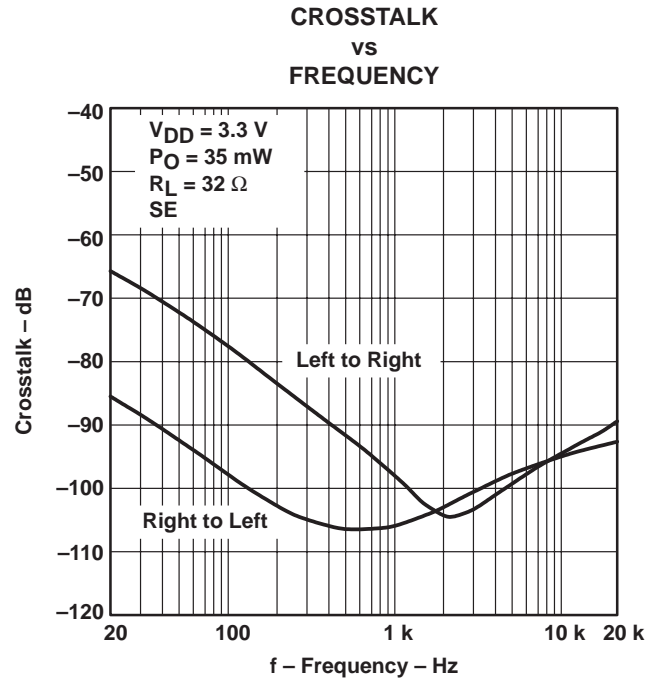

Figure 42

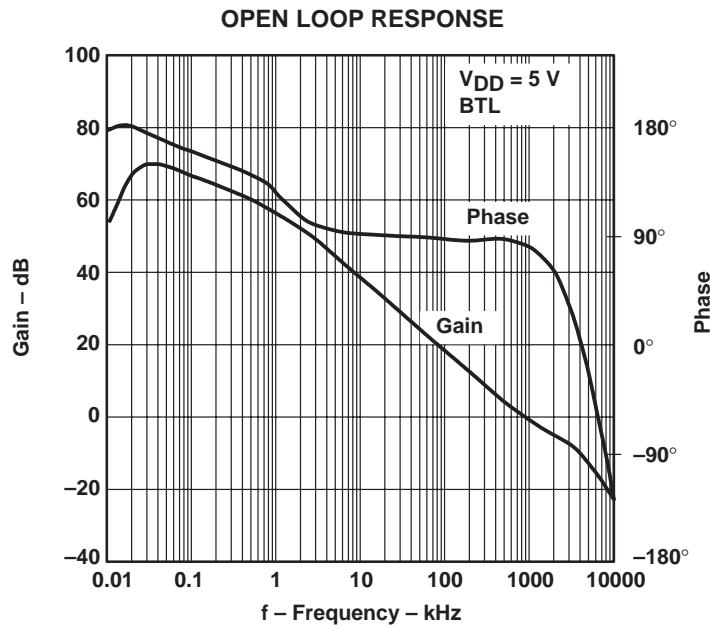

Figure 43

# TPA0102 1.5-W STEREO AUDIO POWER AMPLIFIER

SLOS166E – MARCH 1997 – REVISED MARCH 2000

## TYPICAL CHARACTERISTICS

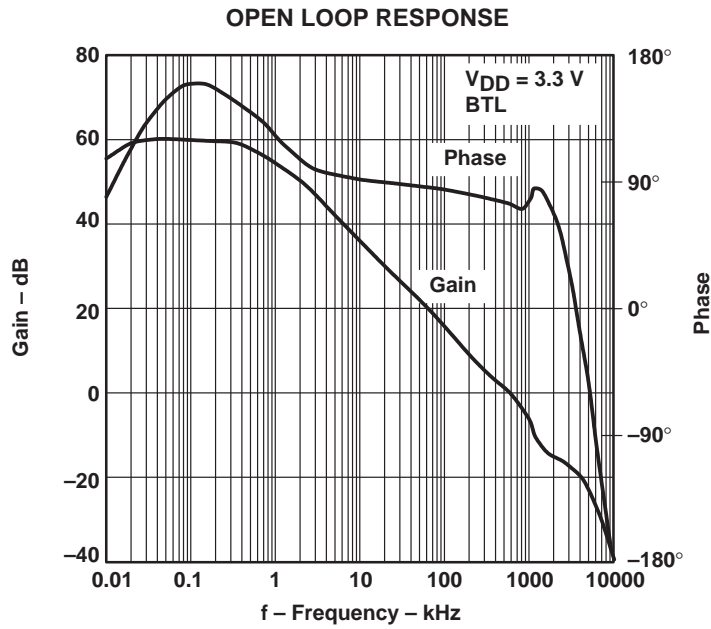

Figure 44

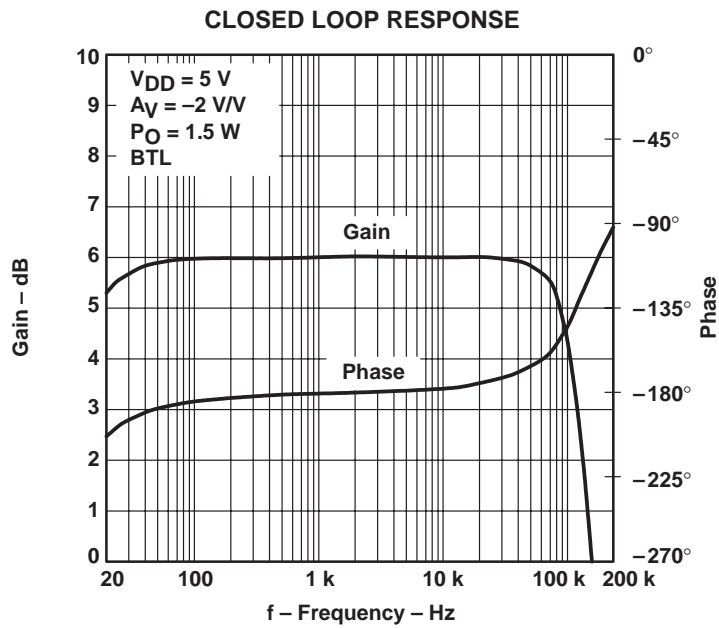

Figure 45

TYPICAL CHARACTERISTICS

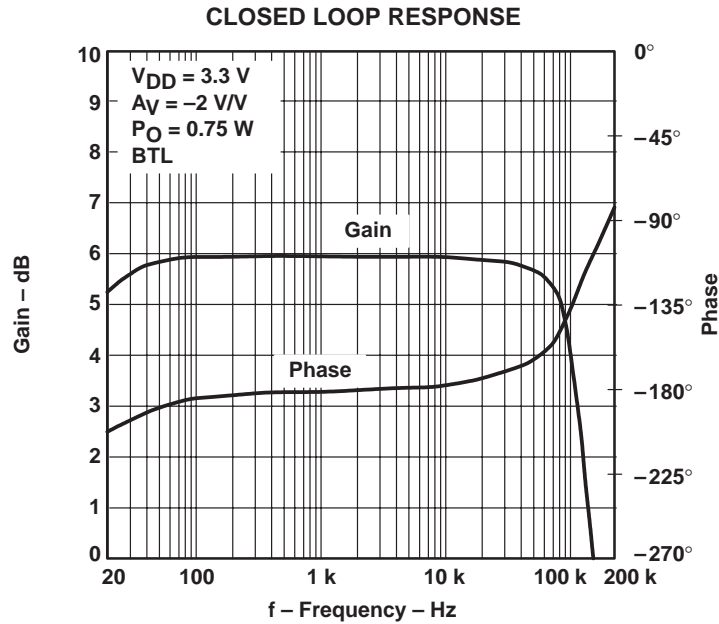

Figure 46

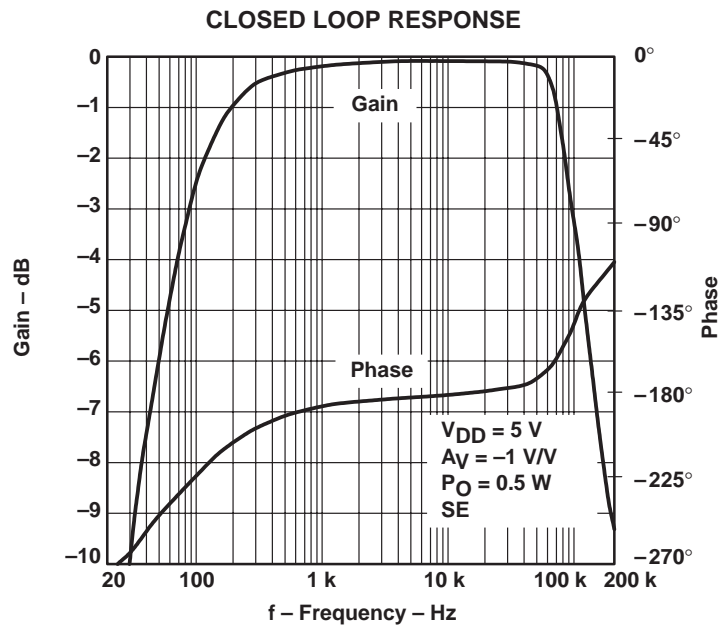

Figure 47

TPA0102  
1.5-W STEREO AUDIO POWER AMPLIFIER

SLOS166E – MARCH 1997 – REVISED MARCH 2000

TYPICAL CHARACTERISTICS

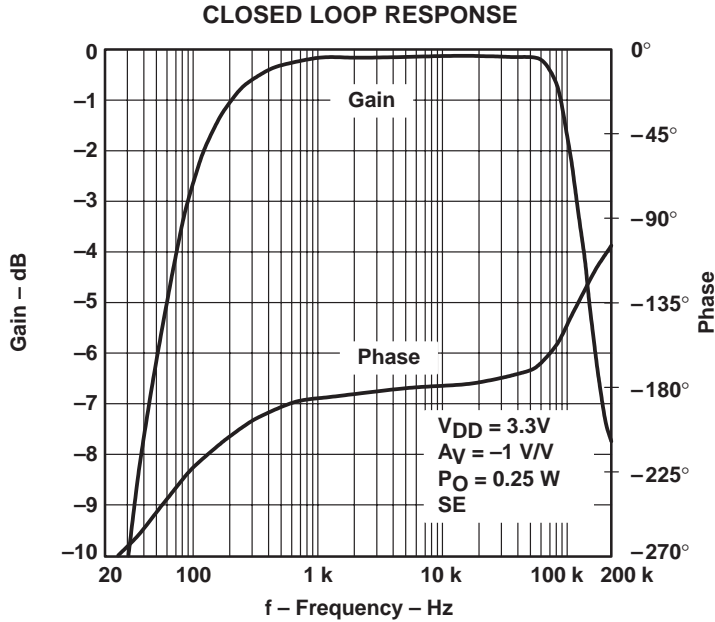

Figure 48

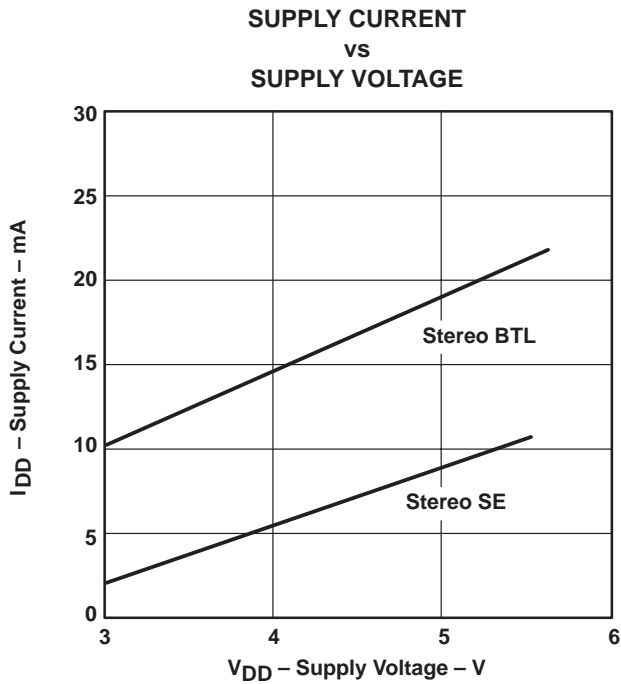

Figure 49

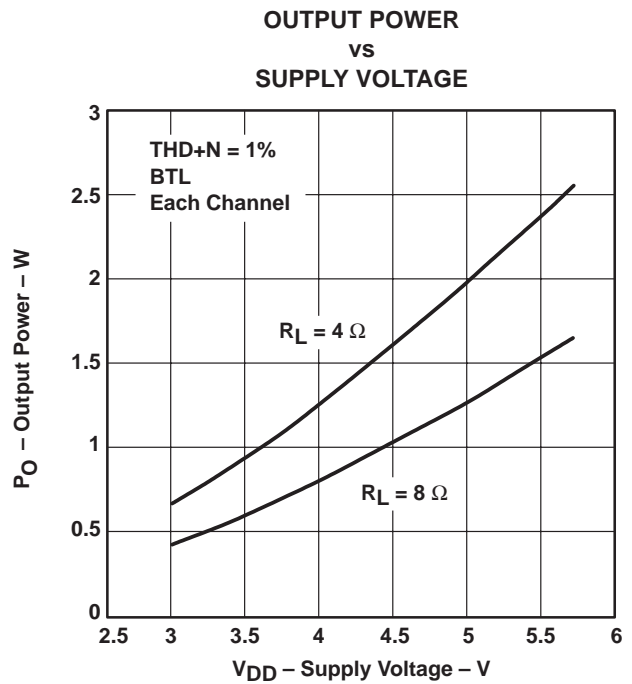

Figure 50



TYPICAL CHARACTERISTICS

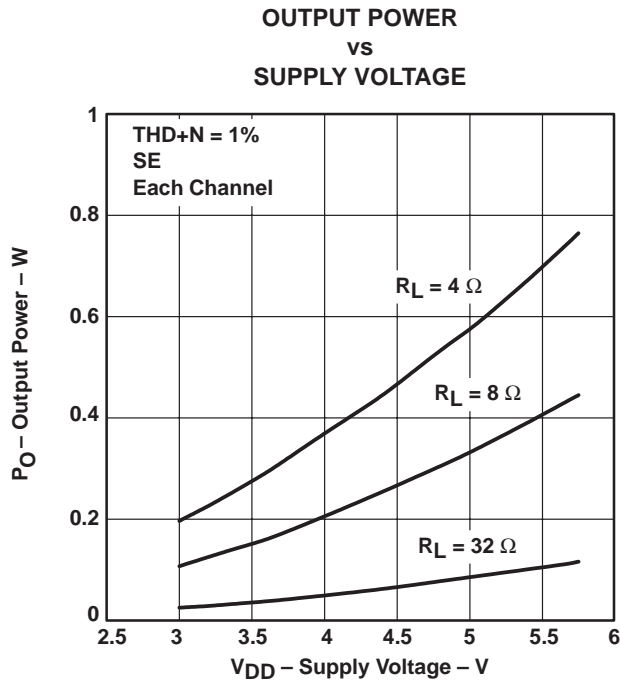

Figure 51

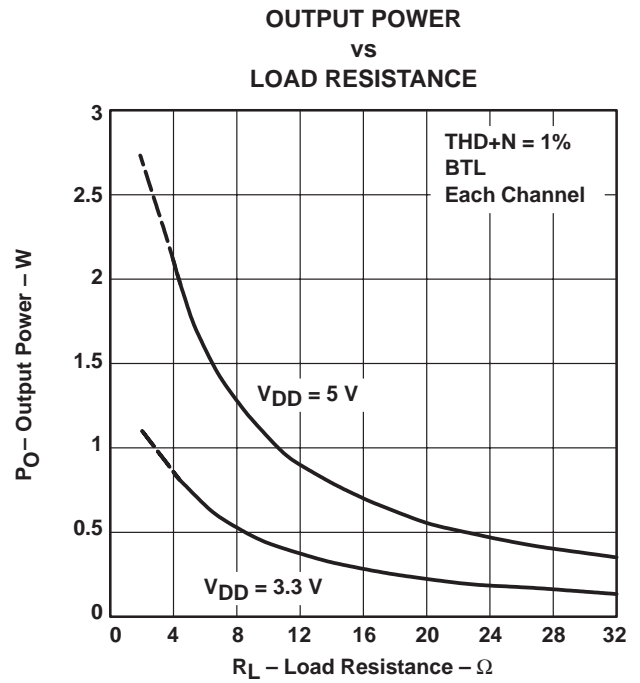

Figure 52

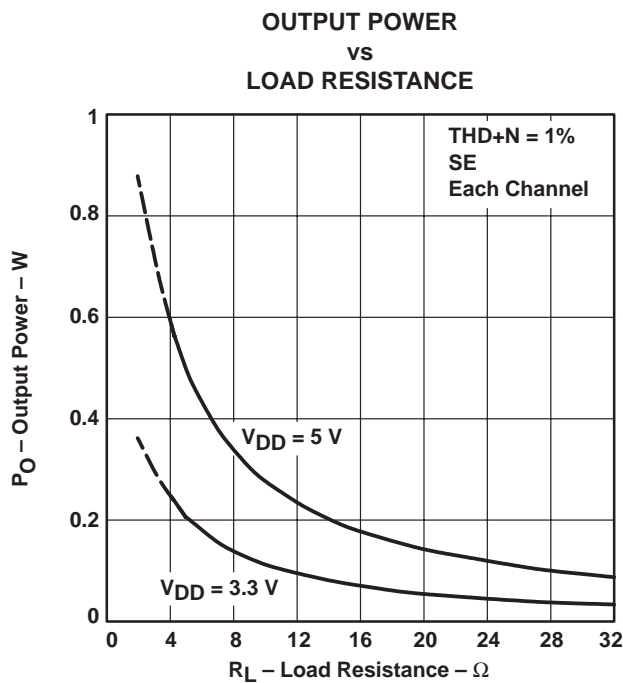

Figure 53

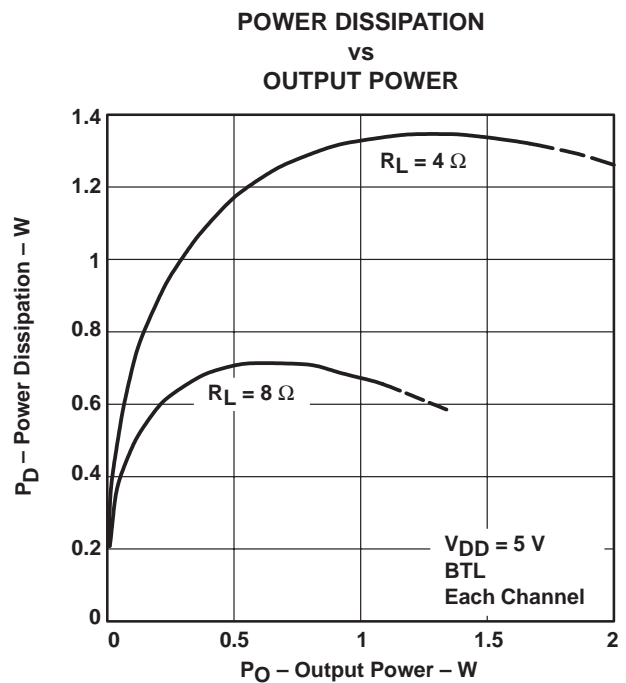
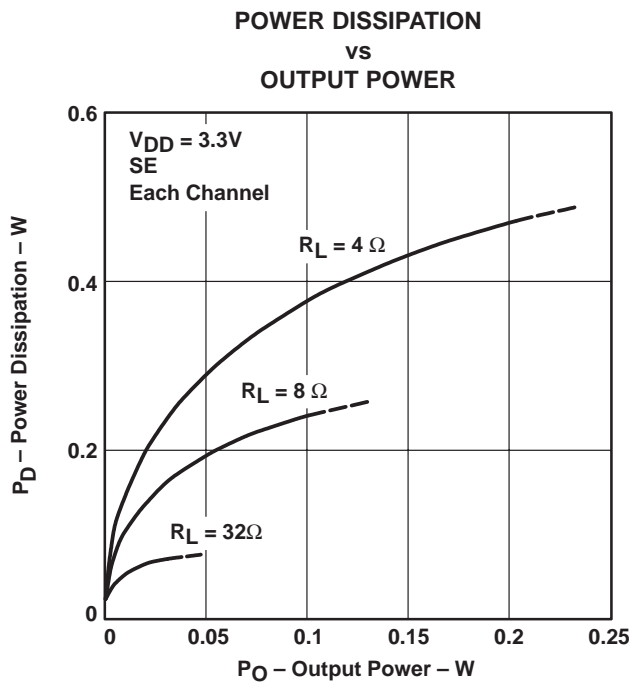
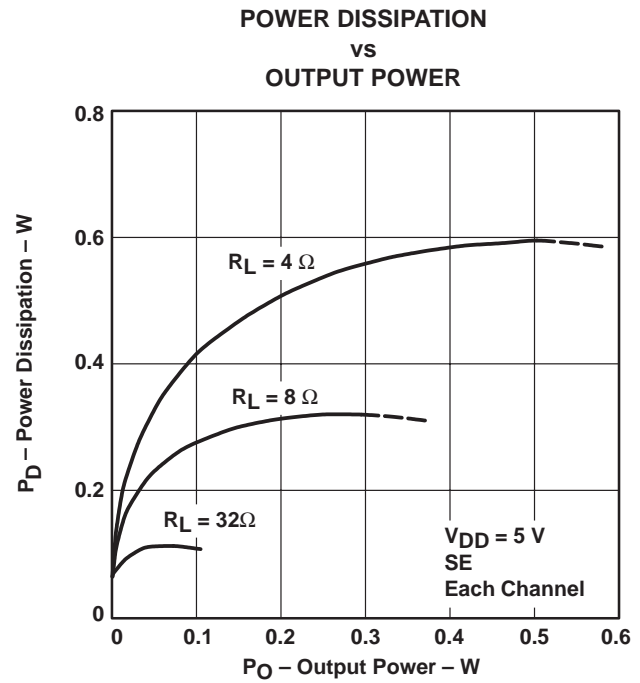
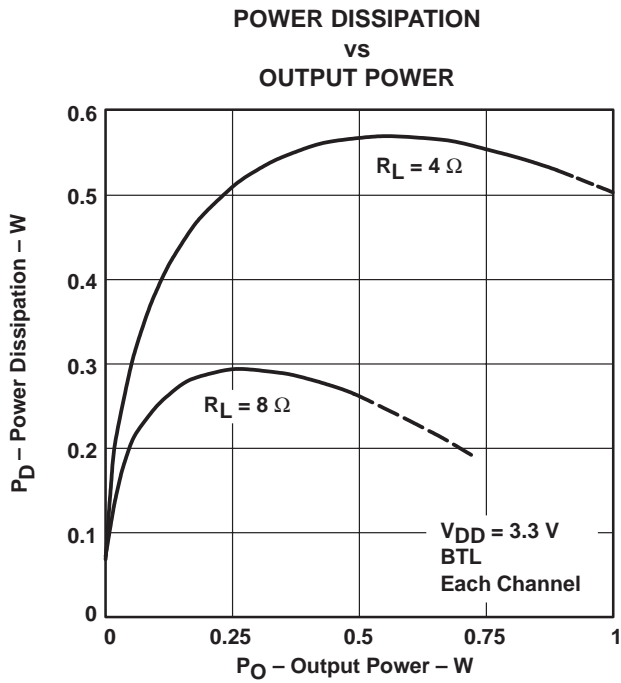

Figure 54

# TPA0102 1.5-W STEREO AUDIO POWER AMPLIFIER

SLOS166E – MARCH 1997 – REVISED MARCH 2000

## TYPICAL CHARACTERISTICS



## THERMAL INFORMATION

The thermally enhanced PWP package is based on the 24-pin TSSOP, but includes a thermal pad (see Figure 58) to provide an effective thermal contact between the IC and the PWB.

Traditionally, surface mount and power have been mutually exclusive terms. A variety of scaled-down TO-220-type packages have leads formed as gull wings to make them applicable for surface-mount applications. These packages, however, have only two shortcomings: they do not address the very low profile requirements (<2 mm) of many of today's advanced systems, and they do not offer a terminal-count high enough to accommodate increasing integration. On the other hand, traditional low-power surface-mount packages require power-dissipation derating that severely limits the usable range of many high-performance analog circuits.

The PowerPAD package (thermally enhanced TSSOP) combines fine-pitch surface-mount technology with thermal performance comparable to much larger power packages.

The PowerPAD package is designed to optimize the heat transfer to the PWB. Because of the very small size and limited mass of a TSSOP package, thermal enhancement is achieved by improving the thermal conduction paths that remove heat from the component. The thermal pad is formed using a patented lead-frame design and manufacturing technique to provide a direct connection to the heat-generating IC. When this pad is soldered or otherwise thermally coupled to an external heat dissipator, high power dissipation in the ultra-thin, fine-pitch, surface-mount package can be reliably achieved.

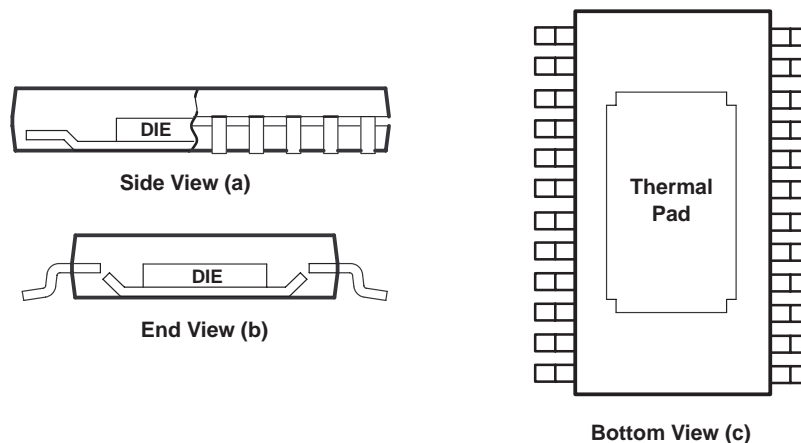

Figure 58. Views of Thermally Enhanced PWP Package

# TPA0102

## 1.5-W STEREO AUDIO POWER AMPLIFIER

SLOS166E – MARCH 1997 – REVISED MARCH 2000

### APPLICATION INFORMATION

#### bridged-tied load versus single-ended mode

Figure 59 shows a linear audio power amplifier (APA) in a BTL configuration. The TPA0102 BTL amplifier consists of two linear amplifiers driving both ends of the load. There are several potential benefits to this differential drive configuration but initially consider power to the load. The differential drive to the speaker means that as one side is slewing up, the other side is slewing down, and vice versa. This in effect doubles the voltage swing on the load as compared to a ground referenced load. Plugging  $2 \times V_{O(PP)}$  into the power equation, where voltage is squared, yields  $4 \times$  the output power from the same supply rail and load impedance (see equation 1).

$$V_{(rms)} = \frac{V_{O(PP)}}{2\sqrt{2}}$$
$$\text{Power} = \frac{V_{(rms)}^2}{R_L} \tag{1}$$

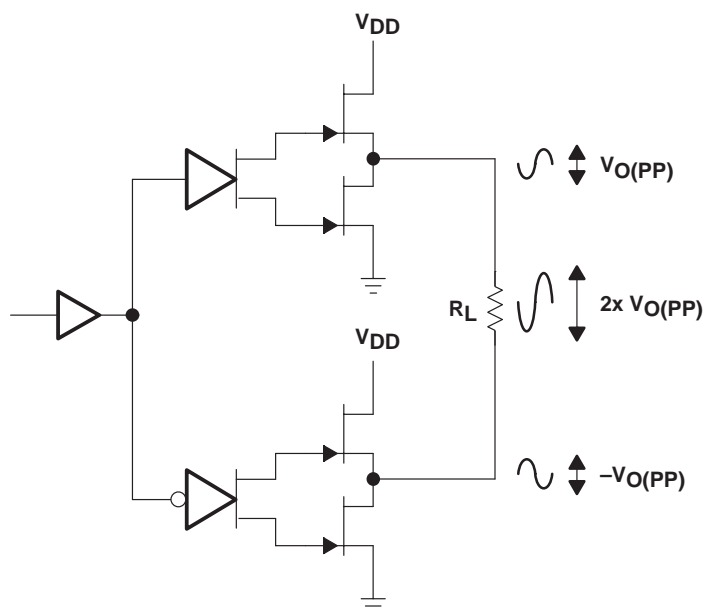

Figure 59. Bridge-Tied Load Configuration

In a typical computer sound channel operating at 5 V, bridging raises the power into an 8-Ω speaker from a single-ended (SE, ground reference) limit of 250 mW to 1 W. In sound power that is a 6-dB improvement — which is loudness that can be heard. In addition to increased power there are frequency response concerns. Consider the single-supply SE configuration shown in Figure 60. A coupling capacitor is required to block the dc offset voltage from reaching the load. These capacitors can be quite large (approximately 33 μF to 1000 μF) so they tend to be expensive, heavy, occupy valuable PCB area, and have the additional drawback of limiting low-frequency performance of the system. This frequency limiting effect is due to the high pass filter network created with the speaker impedance and the coupling capacitance and is calculated with equation 2.



APPLICATION INFORMATION

$$f_c = \frac{1}{2\pi R_L C_C} \tag{2}$$

For example, a 68- $\mu$ F capacitor with an 8- $\Omega$  speaker would attenuate low frequencies below 293 Hz. The BTL configuration cancels the dc offsets, which eliminates the need for the blocking capacitors. Low-frequency performance is then limited only by the input network and speaker response. Cost and PCB space are also minimized by eliminating the bulky coupling capacitor.

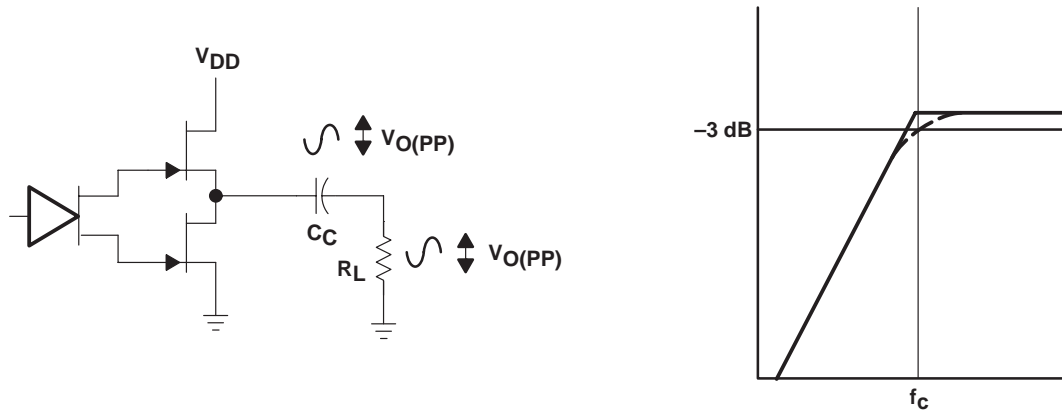

Figure 60. Single-Ended Configuration and Frequency Response

Increasing power to the load does carry a penalty of increased internal power dissipation. The increased dissipation is understandable considering that the BTL configuration produces 4 $\times$  the output power of the SE configuration. Internal dissipation versus output power is discussed further in the *thermal considerations* section.

**BTL amplifier efficiency**

Linear amplifiers are notoriously inefficient. The primary cause of these inefficiencies is voltage drop across the output stage transistors. There are two components of the internal voltage drop. One is the headroom or dc voltage drop that varies inversely to output power. The second component is due to the sinewave nature of the output. The total voltage drop can be calculated by subtracting the RMS value of the output voltage from  $V_{DD}$ . The internal voltage drop multiplied by the RMS value of the supply current,  $I_{DD\text{rms}}$ , determines the internal power dissipation of the amplifier.

An easy-to-use equation to calculate efficiency starts out as being equal to the ratio of power from the power supply to the power delivered to the load. To accurately calculate the RMS values of power in the load and in the amplifier, the current and voltage waveform shapes must first be understood (see Figure 61).

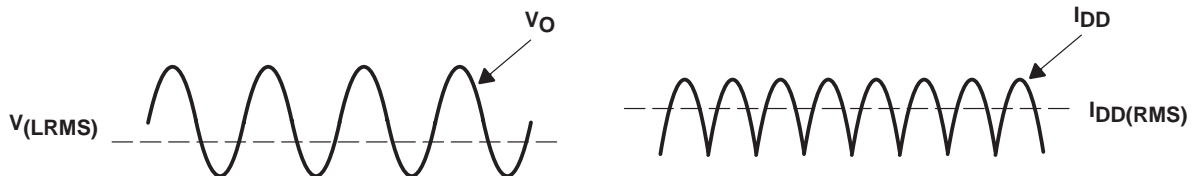

Figure 61. Voltage and Current Waveforms for BTL Amplifiers

# TPA0102

## 1.5-W STEREO AUDIO POWER AMPLIFIER

SLOS166E – MARCH 1997 – REVISED MARCH 2000

### APPLICATION INFORMATION

Although the voltages and currents for SE and BTL are sinusoidal in the load, currents from the supply are very different between SE and BTL configurations. In an SE application the current waveform is a half-wave rectified shape whereas in BTL it is a full-wave rectified waveform. This means RMS conversion factors are different. Keep in mind that for most of the waveform both the push and pull transistors are not on at the same time, which supports the fact that each amplifier in the BTL device only draws current from the supply for half the waveform. The following equations are the basis for calculating amplifier efficiency.

$$\text{Efficiency} = \frac{P_L}{P_{\text{SUP}}} \quad (3)$$

Where:

$$P_L = \frac{V_{L\text{rms}}^2}{R_L} = \frac{V_p^2}{2R_L}$$

$$V_{L\text{rms}} = \frac{V_P}{\sqrt{2}}$$

$$P_{\text{SUP}} = V_{\text{DD}} I_{\text{DD}\text{rms}} = \frac{V_{\text{DD}} 2V_P}{\pi R_L}$$

$$I_{\text{DD}\text{rms}} = \frac{2V_P}{\pi R_L}$$

$$\text{Efficiency of a BTL Configuration} = \frac{\pi V_P}{2V_{\text{DD}}} = \frac{\pi \left( \frac{P_L R_L}{2} \right)^{1/2}}{2V_{\text{DD}}} \quad (4)$$

Table 1 employs equation 4 to calculate efficiencies for four different output power levels. Note that the efficiency of the amplifier is quite low for lower power levels and rises sharply as power to the load is increased resulting in a nearly flat internal power dissipation over the normal operating range. Note that the internal dissipation at full output power is less than in the half power range. Calculating the efficiency for a specific system is the key to proper power supply design. For a stereo 1-W audio system with 8-Ω loads and a 5-V supply, the maximum draw on the power supply is almost 3.25 W.

**Table 1. Efficiency Vs Output Power in 5-V 8-Ω BTL Systems**

OUTPUT POWER (W)	EFFICIENCY (%)	PEAK-TO-PEAK VOLTAGE (V)	INTERNAL DISSIPATION (W)
0.25	31.4	2.00	0.55
0.50	44.4	2.83	0.62
1.00	62.8	4.00	0.59
1.25	70.2	4.47†	0.53

† High peak voltages cause the THD to increase.

A final point to remember about linear amplifiers (either SE or BTL) is how to manipulate the terms in the efficiency equation to utmost advantage when possible. Note that in equation 4,  $V_{\text{DD}}$  is in the denominator. This indicates that as  $V_{\text{DD}}$  goes down, efficiency goes up.

APPLICATION INFORMATION

For example, if the 5-V supply is replaced with a 3.3-V supply (TPA0102 has a maximum recommended  $V_{DD}$  of 5.5 V) in the calculations of Table 1, then efficiency at 0.5 W would rise from 44% to 67% and internal power dissipation would fall from 0.62 W to 0.25 W at 5 V. Then for a stereo 0.5-W system from a 3.3-V supply, the maximum draw would only be 1.5 W as compared to 2.24 W from 5 V. In other words, use the efficiency analysis to chose the correct supply voltage and speaker impedance for the application.

selection of components

Figure 62 and Figure 63 are a schematic diagrams of a typical notebook computer application circuits.

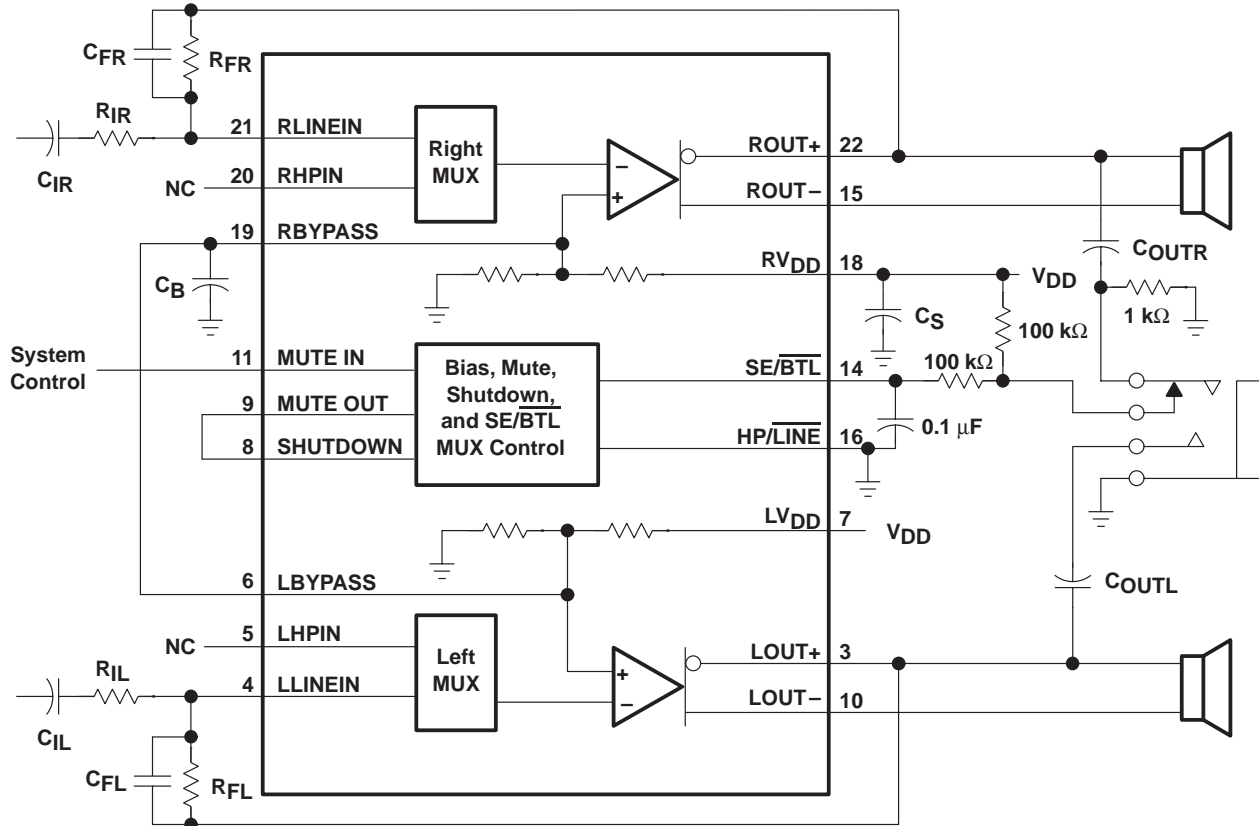
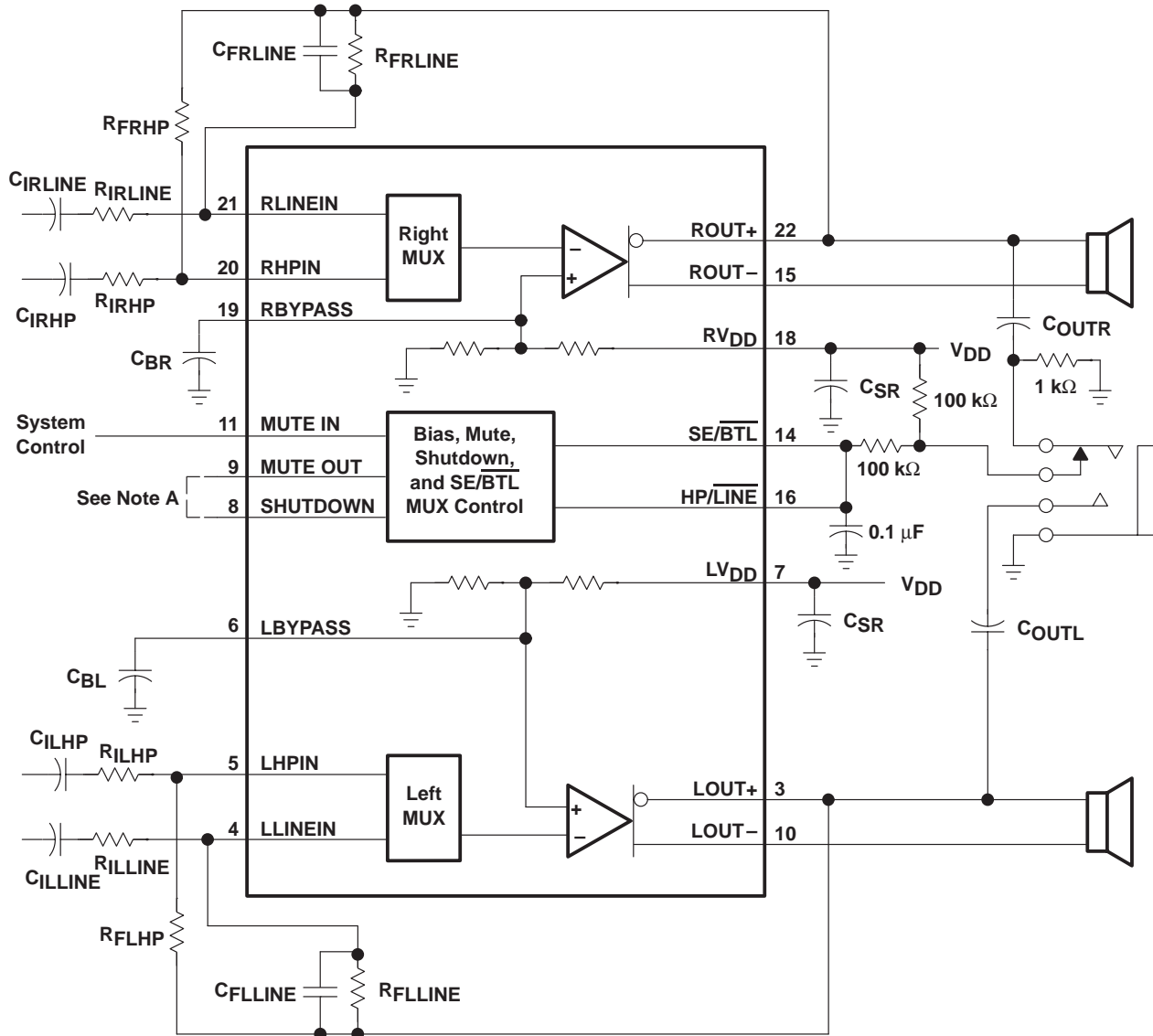

Figure 62. TPA0102 Minimum Configuration Application Circuit

# TPA0102 1.5-W STEREO AUDIO POWER AMPLIFIER

SLOS166E – MARCH 1997 – REVISED MARCH 2000

## APPLICATION INFORMATION



NOTE A: This connection is for ultralow current in shutdown mode.

**Figure 63. TPA0102 Full Configuration Application Circuit**

### gain setting resistors, $R_F$ and $R_I$

The gain for each audio input of the TPA0102 is set by resistors  $R_F$  and  $R_I$  according to equation 5 for BTL mode.

$$\text{BTL Gain} = -2 \left( \frac{R_F}{R_I} \right) \quad (5)$$

APPLICATION INFORMATION

gain setting resistors,  $R_F$  and  $R_I$  (continued)

BTL mode operation brings about the factor 2 in the gain equation due to the inverting amplifier mirroring the voltage swing across the load. Given that the TPA0102 is a MOS amplifier, the input impedance is very high, consequently input leakage currents are not generally a concern although noise in the circuit increases as the value of  $R_F$  increases. In addition, a certain range of  $R_F$  values are required for proper startup operation of the amplifier. Taken together it is recommended that the effective impedance seen by the inverting node of the amplifier be set between 5 k $\Omega$  and 20 k $\Omega$ . The effective impedance is calculated in equation 6.

$$\text{Effective Impedance} = \frac{R_F R_I}{R_F + R_I} \tag{6}$$

As an example consider an input resistance of 10 k $\Omega$  and a feedback resistor of 50 k $\Omega$ . The BTL gain of the amplifier would be -10 and the effective impedance at the inverting terminal would be 8.3 k $\Omega$ , which is well within the recommended range.

For high performance applications metal film resistors are recommended because they tend to have lower noise levels than carbon resistors. For values of  $R_F$  above 50 k $\Omega$  the amplifier tends to become unstable due to a pole formed from  $R_F$  and the inherent input capacitance of the MOS input structure. For this reason, a small compensation capacitor of approximately 5 pF should be placed in parallel with  $R_F$  when  $R_F$  is greater than 50 k $\Omega$ . This, in effect, creates a low pass filter network with the cutoff frequency defined in equation 7.

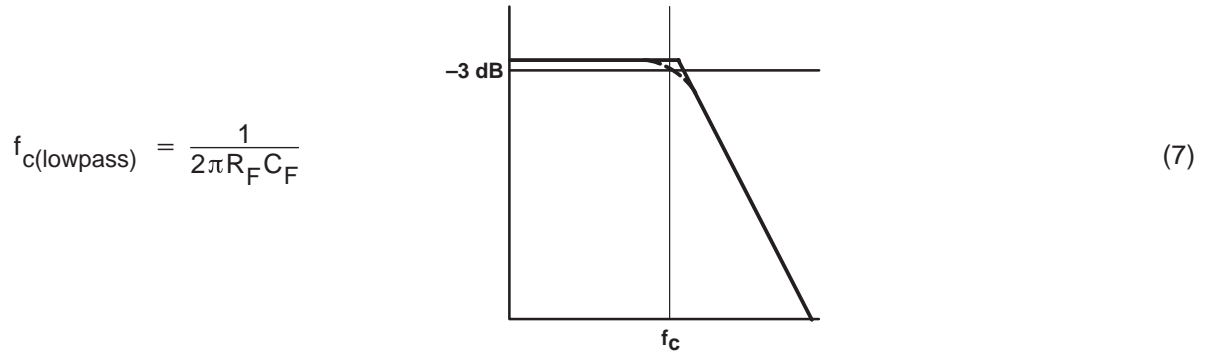

For example, if  $R_F$  is 100 k $\Omega$  and  $C_f$  is 5 pF then  $f_c$  is 318 kHz, which is well outside of the audio range.

input capacitor,  $C_I$

In the typical application an input capacitor,  $C_I$ , is required to allow the amplifier to bias the input signal to the proper dc level for optimum operation. In this case,  $C_I$  and  $R_I$  form a high-pass filter with the corner frequency determined in equation 8.

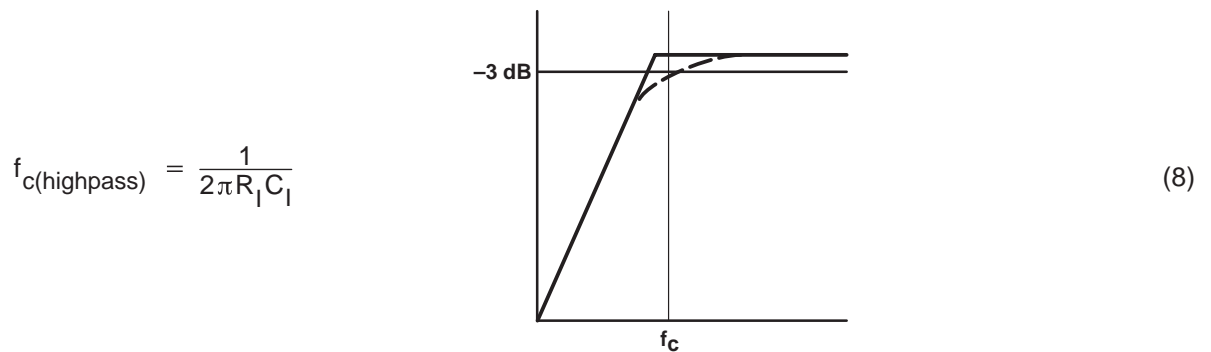

# TPA0102

## 1.5-W STEREO AUDIO POWER AMPLIFIER

SLOS166E – MARCH 1997 – REVISED MARCH 2000

### APPLICATION INFORMATION

#### input capacitor, $C_I$ (continued)

The value of  $C_I$  is important to consider as it directly affects the bass (low frequency) performance of the circuit. Consider the example where  $R_I$  is 10 k $\Omega$  and the specification calls for a flat bass response down to 40 Hz. Equation 8 is reconfigured as equation 9.

$$C_I = \frac{1}{2\pi R_I f_c} \quad (9)$$

In this example,  $C_I$  is 0.40  $\mu\text{F}$  so one would likely choose a value in the range of 0.47  $\mu\text{F}$  to 1  $\mu\text{F}$ . A further consideration for this capacitor is the leakage path from the input source through the input network ( $R_I$ ,  $C_I$ ) and the feedback resistor ( $R_F$ ) to the load. This leakage current creates a dc offset voltage at the input to the amplifier that reduces useful headroom, especially in high gain applications. For this reason a low-leakage tantalum or ceramic capacitor is the best choice. When polarized capacitors are used, the positive side of the capacitor should face the amplifier input in most applications as the dc level there is held at  $V_{DD}/2$ , which is likely higher than the source dc level. Please note that it is important to confirm the capacitor polarity in the application.

#### power supply decoupling, $C_S$

The TPA0102 is a high-performance CMOS audio amplifier that requires adequate power supply decoupling to ensure the output total harmonic distortion (THD) is as low as possible. Power supply decoupling also prevents oscillations for long lead lengths between the amplifier and the speaker. The optimum decoupling is achieved by using two capacitors of different types that target different types of noise on the power supply leads. For higher frequency transients, spikes, or digital hash on the line, a good low equivalent-series-resistance (ESR) ceramic capacitor, typically 0.1  $\mu\text{F}$  placed as close as possible to the device  $V_{DD}$  lead works best. For filtering lower-frequency noise signals, a larger aluminum electrolytic capacitor of 10  $\mu\text{F}$  or greater placed near the audio power amplifier is recommended.

#### midrail bypass capacitor, $C_B$

The midrail bypass capacitor,  $C_B$ , serves several important functions. During startup or recovery from shutdown mode,  $C_B$  determines the rate at which the amplifier starts up. The second function is to reduce noise produced by the power supply caused by coupling into the output drive signal. This noise is from the midrail generation circuit internal to the amplifier. The capacitor is fed from a 25-k $\Omega$  source inside the amplifier. To keep the start-up pop as low as possible, the relationship shown in equation 10 should be maintained.

$$\frac{1}{(C_B \times 25 \text{ k}\Omega)} \leq \frac{1}{(C_I R_I)} \quad (10)$$

As an example, consider a circuit where  $C_B$  is 0.1  $\mu\text{F}$ ,  $C_I$  is 0.22  $\mu\text{F}$  and  $R_I$  is 10 k $\Omega$ . Inserting these values into the equation 10 we get  $400 \leq 454$  which satisfies the rule. Bypass capacitor,  $C_B$ , values of 0.1  $\mu\text{F}$  to 1  $\mu\text{F}$  ceramic or tantalum low-ESR capacitors are recommended for the best THD and noise performance.

In Figure 63, the full feature configuration, two bypass capacitors are used. This provides the maximum separation between right and left drive circuits. When absolute minimum cost and/or component space is required, one bypass capacitor can be used as shown in Figure 62. It is critical that terminals 6 and 19 be tied together in this configuration.

APPLICATION INFORMATION

single-ended operation

In SE mode (see Figure 59 and Figure 60), the load is driven from the primary amplifier output for each channel (OUT+, terminals 22 and 3).

In SE mode the gain is set by the  $R_F$  and  $R_I$  resistors and is shown in equation 11. Since the inverting amplifier is not used to mirror the voltage swing on the load, the factor of 2, from equation 5, is not included.

$$\text{SE Gain} = - \left( \frac{R_F}{R_I} \right) \tag{11}$$

The output coupling capacitor required in single-supply SE mode also places additional constraints on the selection of other components in the amplifier circuit. The rules described earlier still hold with the addition of the following relationship:

$$\frac{1}{(C_B \times 25 \text{ k}\Omega)} \leq \frac{1}{(C_I R_I)} \ll \frac{1}{R_L C_C} \tag{12}$$

output coupling capacitor,  $C_C$

In the typical single-supply SE configuration, an output coupling capacitor ( $C_C$ ) is required to block the dc bias at the output of the amplifier thus preventing dc currents in the load. As with the input coupling capacitor, the output coupling capacitor and impedance of the load form a high-pass filter governed by equation 13.

$$f_{c(\text{high})} = \frac{1}{2\pi R_L C_C} \tag{13}$$

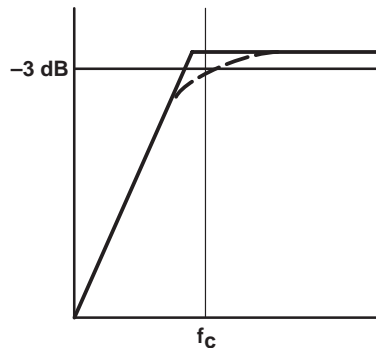

The main disadvantage, from a performance standpoint, is the load impedances are typically small, which drives the low-frequency corner higher degrading the bass response. Large values of  $C_C$  are required to pass low frequencies into the load. Consider the example where a  $C_C$  of 330  $\mu\text{F}$  is chosen and loads vary from 4  $\Omega$ , 8  $\Omega$ , 32  $\Omega$ , to 47 k $\Omega$ . Table 2 summarizes the frequency response characteristics of each configuration.

Table 2. Common Load Impedances Vs Low Frequency Output Characteristics in SE Mode

$R_L$	$C_C$	LOWEST FREQUENCY
4 $\Omega$	330 $\mu\text{F}$	120 Hz
8 $\Omega$	330 $\mu\text{F}$	60 Hz
32 $\Omega$	330 $\mu\text{F}$	15 Hz
47,000 $\Omega$	330 $\mu\text{F}$	0.01 Hz

As Table 2 indicates, most of the bass response is attenuated into a 4- $\Omega$  load, an 8- $\Omega$  load is adequate, headphone response is good, and drive into line level inputs (a home stereo for example) is exceptional.

# TPA0102

## 1.5-W STEREO AUDIO POWER AMPLIFIER

SLOS166E – MARCH 1997 – REVISED MARCH 2000

### APPLICATION INFORMATION

#### SE/BTL operation

The ability of the TPA0102 to easily switch between BTL and SE modes is one of its most important cost saving features. This feature eliminates the requirement for an additional headphone amplifier in applications where internal stereo speakers are driven in BTL mode but external headphone or speakers must be accommodated. Internal to the TPA0102, two separate amplifiers drive OUT+ and OUT-. The SE/BTL input (terminal 14) controls the operation of the follower amplifier that drives LOU- and ROU- (terminals 10 and 15). When SE/BTL is held low, the amplifier is on and the TPA0102 is in the BTL mode. When SE/BTL is held high, the OUT- amplifiers are in a high output impedance state, which configures the TPA0102 as an SE driver from LOU+ and ROU+ (terminals 3 and 22).  $I_{DD}$  is reduced by approximately one-half in SE mode. Control of the SE/BTL input can be from a logic-level CMOS source or, more typically, from a resistor divider network as shown in Figure 64.

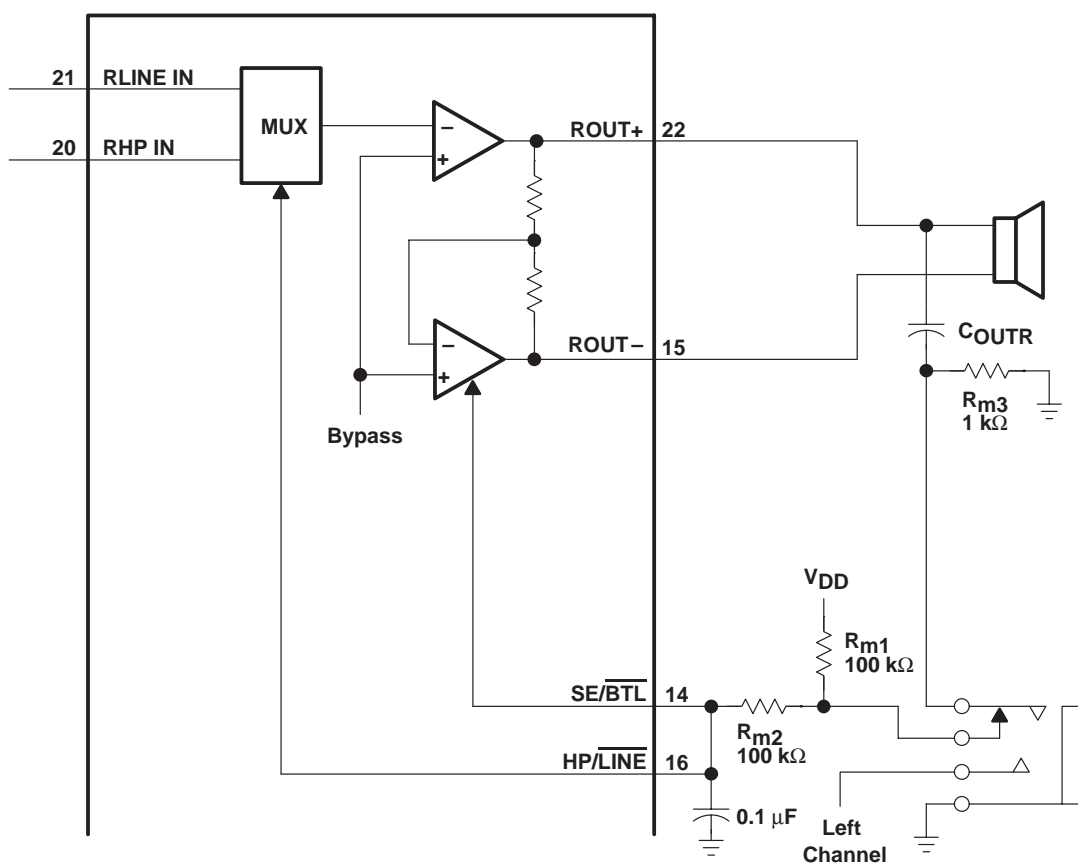

Figure 64. TPA0102 Resistor Divider Network Circuit

Using a readily available 1/8-in. (3.5 mm) stereo headphone jack, the control switch is closed when no plug is inserted. When closed the 100-kΩ/1-kΩ divider pulls the SE/BTL input low. When a plug is inserted, the 1-kΩ resistor is disconnected and the SE/BTL input is pulled high. When the input goes high, the OUT- amplifier is shutdown causing the speaker to mute (virtually open-circuits the speaker). The OUT+ amplifier then drives through the output capacitor ( $C_O$ ) into the headphone jack.

As shown in the full feature application (Figure 63), the input MUX control can be tied to the SE/BTL input. The benefits of doing this are described in the following input MUX operation section.



APPLICATION INFORMATION

Input MUX operation

Working in concert with the SE/BTL feature, the HP/LINE MUX feature gives the audio designer the flexibility of a multichip design in a single IC (see Figure 65). The primary function of the MUX is to allow different gain settings for BTL versus SE mode. Speakers typically require approximately a factor of 10 more gain for similar volume listening levels as compared to headphones. To achieve headphone and speaker listening parity, the resistor values would need to be set as follows:

$$\text{SE Gain}_{(\text{HP})} = - \left( \frac{R_{F(\text{HP})}}{R_{I(\text{HP})}} \right) \tag{14}$$

If, for example  $R_{I(\text{HP})} = 20 \text{ k}\Omega$  and  $R_{F(\text{HP})} = 20 \text{ k}\Omega$  then  $\text{SE Gain}_{(\text{HP})} = -1$

$$\text{BTL Gain}_{(\text{LINE})} = - 2 \left( \frac{R_{F(\text{LINE})}}{R_{I(\text{LINE})}} \right) \tag{15}$$

If, for example  $R_{I(\text{LINE})} = 20 \text{ k}\Omega$  and  $R_{F(\text{LINE})} = 100 \text{ k}\Omega$  then  $\text{BTL Gain}_{(\text{LINE})} = -10$

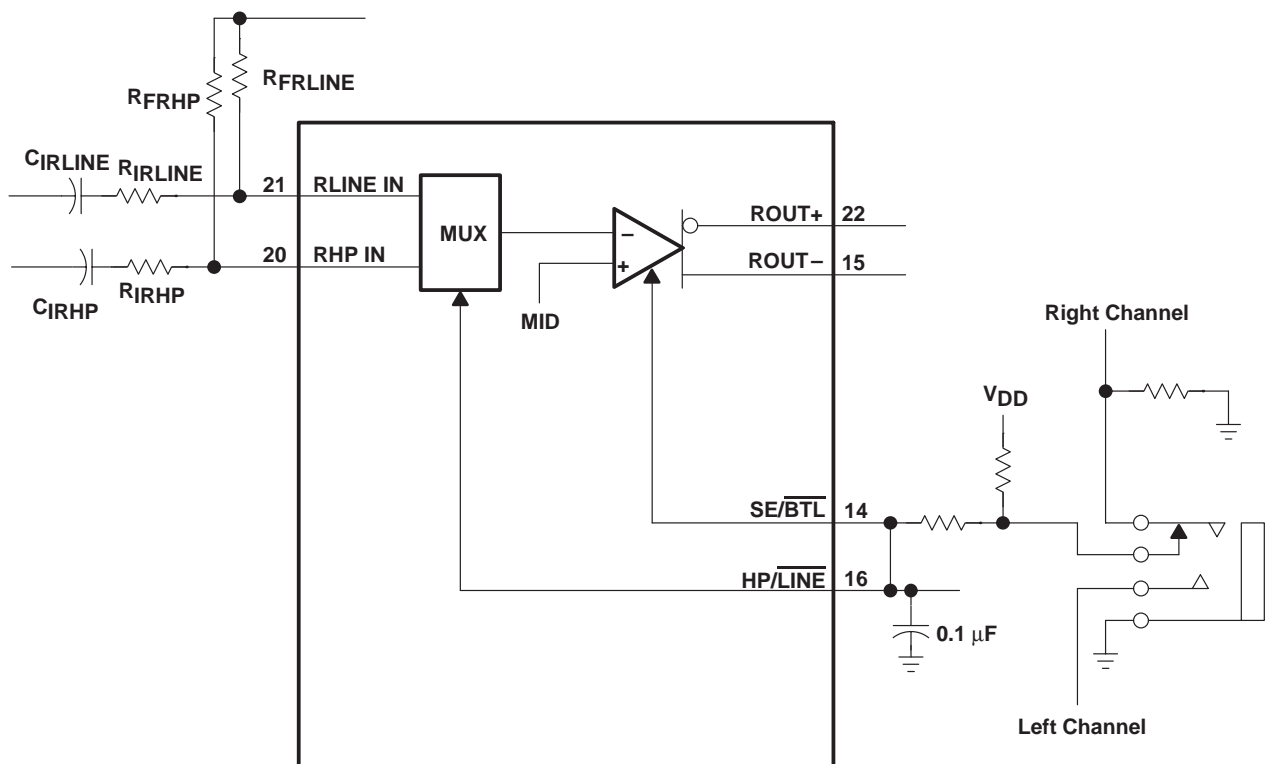

Figure 65. TPA0102 Example Input MUX Circuit

Another advantage of using the MUX feature is setting the gain of the headphone channel to  $-1$ . This provides the optimum distortion performance into the headphones where clear sound is more important. Refer to the SE/BTL operation section for a description of the headphone jack control circuit.

# TPA0102

## 1.5-W STEREO AUDIO POWER AMPLIFIER

SLOS166E – MARCH 1997 – REVISED MARCH 2000

### APPLICATION INFORMATION

#### mute and shutdown modes

The TPA0102 employs both a mute and a shutdown mode of operation designed to reduce supply current,  $I_{DD}$ , to the absolute minimum level during periods of nonuse for battery-power conservation. The SHUTDOWN input terminal should be held low during normal operation when the amplifier is in use. Pulling SHUTDOWN high causes the outputs to mute and the amplifier to enter a low-current state,  $I_{DD} < 1 \mu\text{A}$ . SHUTDOWN or MUTE IN should never be left unconnected because amplifier operation would be unpredictable. Mute mode alone reduces  $I_{DD} < 1 \text{ mA}$ .

**Table 3. Shutdown and Mute Mode Functions**

INPUTS†				OUTPUT	AMPLIFIER STATE	
SE/ $\overline{\text{BTL}}$	HP/ $\overline{\text{LINE}}$	MUTE IN	SHUTDOWN	MUTE OUT	INPUT	OUTPUT
Low	Low	Low	Low	Low	L/R Line	BTL
X	X	—	High	—	X	Mute
X	X	High	—	High	X	Mute
Low	High	Low	Low	Low	L/R HP	BTL
High	Low	Low	Low	Low	L/R Line	SE
High	High	Low	Low	Low	L/R HP	SE

† Inputs should never be left unconnected.

X = do not care

#### using low-ESR capacitors

Low-ESR capacitors are recommended throughout this applications section. A real (as opposed to ideal) capacitor can be modeled simply as a resistor in series with an ideal capacitor. The voltage drop across this resistor minimizes the beneficial effects of the capacitor in the circuit. The lower the equivalent value of this resistance the more the real capacitor behaves like an ideal capacitor.

#### 5-V versus 3.3-V operation

The TPA0102 operates over a supply range of 3 V to 5.5 V. This data sheet provides full specifications for 5-V and 3.3-V operation, as these are considered to be the two most common standard voltages. There are no special considerations for 3.3-V versus 5-V operation as far as supply bypassing, gain setting, or stability goes. For 3.3-V operation, supply current is reduced from 19 mA (typical) to 13 mA (typical). The most important consideration is that of output power. Each amplifier in TPA0102 can produce a maximum voltage swing of  $V_{DD} - 1 \text{ V}$ . This means, for 3.3-V operation, clipping starts to occur when  $V_{O(PP)} = 2.3 \text{ V}$  as opposed to  $V_{O(PP)} = 4 \text{ V}$  at 5 V. The reduced voltage swing subsequently reduces maximum output power into an 8- $\Omega$  load before distortion becomes significant.

Operation from 3.3-V supplies, as can be shown from the efficiency formula in equation 4, consumes approximately two-thirds the supply power for a given output-power level than operation from 5-V supplies. When the application demands less than 500 mW, 3.3-V operation should be strongly considered, especially in battery-powered applications.



POST OFFICE BOX 655303 • DALLAS, TEXAS 75265

## APPLICATION INFORMATION

### headroom and thermal considerations

Linear power amplifiers dissipate a significant amount of heat in the package under normal operating conditions. A typical music CD requires 12 dB to 15 dB of dynamic headroom to pass the loudest portions without distortion as compared with the average power output. From the TPA0102 data sheet, one can see that when the TPA0102 is operating from a 5-V supply into a 4-Ω speaker that 1.5 W peaks are available. Converting watts to dB:

$$\begin{aligned} P_{dB} &= 10\text{Log} \left( \frac{P_W}{P_{ref}} \right) \\ &= 10\text{Log} \left( \frac{1.5}{1} \right) \\ &= 1.76 \text{ dB} \end{aligned}$$

Subtracting the headroom restriction to obtain the average listening level without distortion yields:

$$\begin{aligned} 1.76 \text{ dB} - 15 \text{ dB} &= -13.24 \text{ dB (15 dB headroom)} \\ 1.76 \text{ dB} - 12 \text{ dB} &= -10.24 \text{ dB (12 dB headroom)} \\ 1.76 \text{ dB} - 9 \text{ dB} &= -7.24 \text{ dB (9 dB headroom)} \\ 1.76 \text{ dB} - 6 \text{ dB} &= -4.24 \text{ dB (6 dB headroom)} \\ 1.76 \text{ dB} - 3 \text{ dB} &= -1.24 \text{ dB (3 dB headroom)} \end{aligned}$$

Converting dB back into watts:

$$\begin{aligned} P_W &= 10^{P_{dB}/10} \times P_{ref} \\ &= 47 \text{ mW (15 dB headroom)} \\ &= 94 \text{ mW (12 dB headroom)} \\ &= 188 \text{ mW (9 dB headroom)} \\ &= 376 \text{ mW (6 dB headroom)} \\ &= 752 \text{ mW (3 dB headroom)} \end{aligned}$$

This is valuable information to consider when attempting to estimate the heat dissipation requirements for the amplifier system. Comparing the absolute worst case, which is 1.5 W of continuous power output with 0 dB of headroom, against 12 dB and 15 dB applications drastically affects maximum ambient temperature ratings for the system. Using the power dissipation curves for a 5-V, 4-Ω system, the internal dissipation in the TPA0102 and maximum ambient temperatures is shown in Table 4.

**Table 4. TPA0102 Power Rating, 5-V, 4-Ω, Stereo**

PEAK OUTPUT POWER (W)	AVERAGE OUTPUT POWER	POWER DISSIPATION (W/Channel)	MAXIMUM AMBIENT TEMPERATURE
1.5	1.5 W	1.35	28°C
1.5	752 mW (3 dB)	1.3	33°C
1.5	376 mW (6 dB)	0.9	69°C
1.5	188 mW (9 dB)	0.7	87°C
1.5	94 mW (12 dB)	0.55	100°C
1.5	47 mW (15 dB)	0.4	114°C

# TPA0102

## 1.5-W STEREO AUDIO POWER AMPLIFIER

SLOS166E – MARCH 1997 – REVISED MARCH 2000

### APPLICATION INFORMATION

#### headroom and thermal considerations (continued)

DISSIPATION RATING TABLE

PACKAGE	T <sub>A</sub> ≤ 25°C	DERATING FACTOR	T <sub>A</sub> = 70°C	T <sub>A</sub> = 85°C
PWP†	2.7 W	21.8 mW/°C	1.7 W	1.4 W
PWP‡	2.8 W	22.1 mW/°C	1.8 W	1.4 W

† This parameter is measured with the recommended copper heat sink pattern on a 1-layer PCB, 4 in<sup>2</sup> 5-in × 5-in PCB, 1 oz. copper, 2-in × 2-in coverage.

‡ This parameter is measured with the recommended copper heat sink pattern on an 8-layer PCB, 6.9 in<sup>2</sup> 1.5-in × 2-in PCB, 1 oz. copper with layers 1, 2, 4, 5, 7, and 8 at 5% coverage (0.9 in<sup>2</sup>) and layers 3 and 6 at 100% coverage (6 in<sup>2</sup>).

The maximum ambient temperature depends on the heatsinking ability of the PCB system. Using the 0 CFM and 300 CFM data from the dissipation rating table, the derating factor for the PWP package with 6.9 in<sup>2</sup> of copper area on a multilayer PCB is 22 mW/°C and 54 mW/°C respectively. Converting this to  $\Theta_{JA}$ :

$$\begin{aligned} \Theta_{JA} &= \frac{1}{\text{Derating}} \\ &= \frac{1}{0.022} \\ &= 45^\circ\text{C/W} \end{aligned}$$

To calculate maximum ambient temperatures, first consider that the numbers from the dissipation graphs are per channel so the dissipated heat needs to be doubled for two channel operation. Given  $\Theta_{JA}$ , the maximum allowable junction temperature, and the total internal dissipation, the maximum ambient temperature can be calculated with the following equation. The maximum recommended junction temperature for the TPA0102 is 150 °C. The internal dissipation figures are taken from the Power Dissipation vs Output Power graphs.

$$\begin{aligned} T_A \text{ Max} &= T_J \text{ Max} - \Theta_{JA} P_D \\ &= 150 - 45(0.4 \times 2) = 114^\circ\text{C} \text{ (15 dB headroom, 0 CFM)} \end{aligned}$$

**NOTE:**

Internal dissipation of 0.4 W is estimated for a 1.5-W system with 15 dB headroom per channel.

Table 4 shows that for most applications no airflow is required to keep junction temperatures in the specified range. The TPA0102 is designed with thermal protection that turns the device off when the junction temperature surpasses 150°C to prevent damage to the IC. Table 4 was calculated for maximum listening volume without distortion. When the output level is reduced the numbers in the table change significantly. Also, using 8-Ω speakers dramatically increases the thermal performance by increasing amplifier efficiency.



# TPA0102 1.5-W STEREO AUDIO POWER AMPLIFIER

SLOS166E – MARCH 1997 – REVISED MARCH 2000

PWP (R-PDSO-G\*\*)

PowerPAD™ PLASTIC SMALL-OUTLINE

20 PINS SHOWN

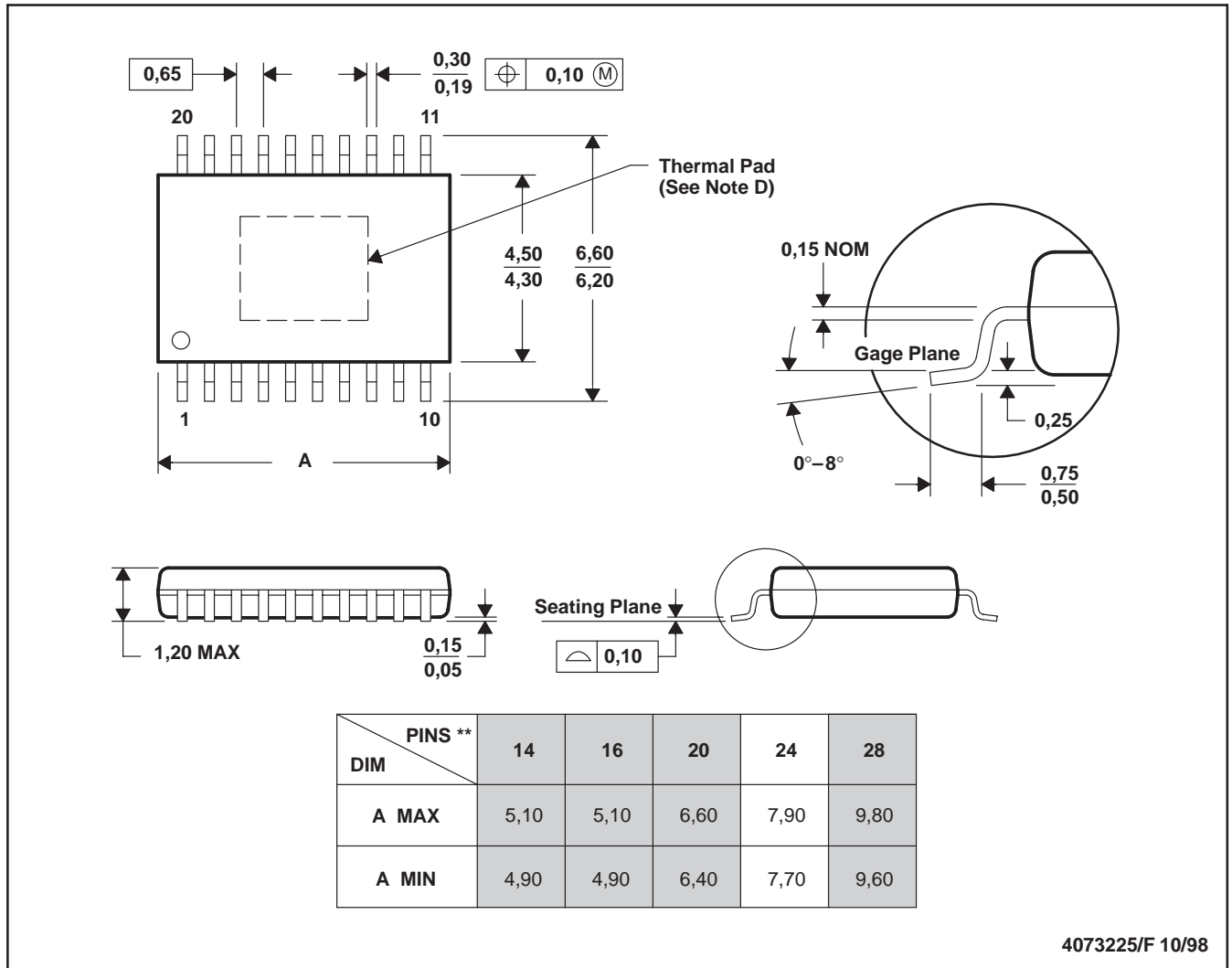

4073225/F 10/98

- NOTES:
- A. All linear dimensions are in millimeters.
  - B. This drawing is subject to change without notice.
  - C. Body dimensions do not include mold flash or protrusions.
  - D. The package thermal performance may be enhanced by bonding the thermal pad to an external thermal plane. This pad is electrically and thermally connected to the backside of the die and possibly selected leads.
  - E. Falls within JEDEC MO-153

For the latest package information, go to [http://www.ti.com/sc/docs/package/pkg\\_info.htm](http://www.ti.com/sc/docs/package/pkg_info.htm)  
PowerPAD is a trademark of Texas Instruments Incorporated.



POST OFFICE BOX 655303 • DALLAS, TEXAS 75265

**PACKAGING INFORMATION**

Orderable Device	Status <sup>(1)</sup>	Package Type	Package Drawing	Pins	Package Qty	Eco Plan <sup>(2)</sup>	Lead/Ball Finish	MSL Peak Temp <sup>(3)</sup>
TPA0102PWP	ACTIVE	HTSSOP	PWP	24	60	Green (RoHS & no Sb/Br)	CU NIPDAU	Level-2-260C-1 YEAR
TPA0102PWPG4	ACTIVE	HTSSOP	PWP	24	60	Green (RoHS & no Sb/Br)	CU NIPDAU	Level-2-260C-1 YEAR
TPA0102PWPLE	OBSOLETE	HTSSOP	PWP	24		TBD	Call TI	Call TI
TPA0102PWPR	ACTIVE	HTSSOP	PWP	24	2000	Green (RoHS & no Sb/Br)	CU NIPDAU	Level-2-260C-1 YEAR
TPA0102PWPRG4	ACTIVE	HTSSOP	PWP	24	2000	Green (RoHS & no Sb/Br)	CU NIPDAU	Level-2-260C-1 YEAR

<sup>(1)</sup> The marketing status values are defined as follows:

**ACTIVE:** Product device recommended for new designs.

**LIFEBUY:** TI has announced that the device will be discontinued, and a lifetime-buy period is in effect.

**NRND:** Not recommended for new designs. Device is in production to support existing customers, but TI does not recommend using this part in a new design.

**PREVIEW:** Device has been announced but is not in production. Samples may or may not be available.

**OBSOLETE:** TI has discontinued the production of the device.

<sup>(2)</sup> Eco Plan - The planned eco-friendly classification: Pb-Free (RoHS), Pb-Free (RoHS Exempt), or Green (RoHS & no Sb/Br) - please check <http://www.ti.com/productcontent> for the latest availability information and additional product content details.

**TBD:** The Pb-Free/Green conversion plan has not been defined.

**Pb-Free (RoHS):** TI's terms "Lead-Free" or "Pb-Free" mean semiconductor products that are compatible with the current RoHS requirements for all 6 substances, including the requirement that lead not exceed 0.1% by weight in homogeneous materials. Where designed to be soldered at high temperatures, TI Pb-Free products are suitable for use in specified lead-free processes.

**Pb-Free (RoHS Exempt):** This component has a RoHS exemption for either 1) lead-based flip-chip solder bumps used between the die and package, or 2) lead-based die adhesive used between the die and leadframe. The component is otherwise considered Pb-Free (RoHS compatible) as defined above.

**Green (RoHS & no Sb/Br):** TI defines "Green" to mean Pb-Free (RoHS compatible), and free of Bromine (Br) and Antimony (Sb) based flame retardants (Br or Sb do not exceed 0.1% by weight in homogeneous material)

<sup>(3)</sup> MSL, Peak Temp. -- The Moisture Sensitivity Level rating according to the JEDEC industry standard classifications, and peak solder temperature.

**Important Information and Disclaimer:**The information provided on this page represents TI's knowledge and belief as of the date that it is provided. TI bases its knowledge and belief on information provided by third parties, and makes no representation or warranty as to the accuracy of such information. Efforts are underway to better integrate information from third parties. TI has taken and continues to take reasonable steps to provide representative and accurate information but may not have conducted destructive testing or chemical analysis on incoming materials and chemicals. TI and TI suppliers consider certain information to be proprietary, and thus CAS numbers and other limited information may not be available for release.

In no event shall TI's liability arising out of such information exceed the total purchase price of the TI part(s) at issue in this document sold by TI to Customer on an annual basis.

**TAPE AND REEL INFORMATION**



**QUADRANT ASSIGNMENTS FOR PIN 1 ORIENTATION IN TAPE**



\*All dimensions are nominal

Device	Package Type	Package Drawing	Pins	SPQ	Reel Diameter (mm)	Reel Width W1 (mm)	A0 (mm)	B0 (mm)	K0 (mm)	P1 (mm)	W (mm)	Pin1 Quadrant
TPA0102PWPR	HTSSOP	PWP	24	2000	330.0	16.4	6.95	8.3	1.6	8.0	16.0	Q1

**TAPE AND REEL BOX DIMENSIONS**



\*All dimensions are nominal

Device	Package Type	Package Drawing	Pins	SPQ	Length (mm)	Width (mm)	Height (mm)
TPA0102PWPR	HTSSOP	PWP	24	2000	346.0	346.0	33.0



PWP (R-PDSO-G\*\*) 20 PIN SHOWN

PowerPAD™ PLASTIC SMALL-OUTLINE PACKAGE

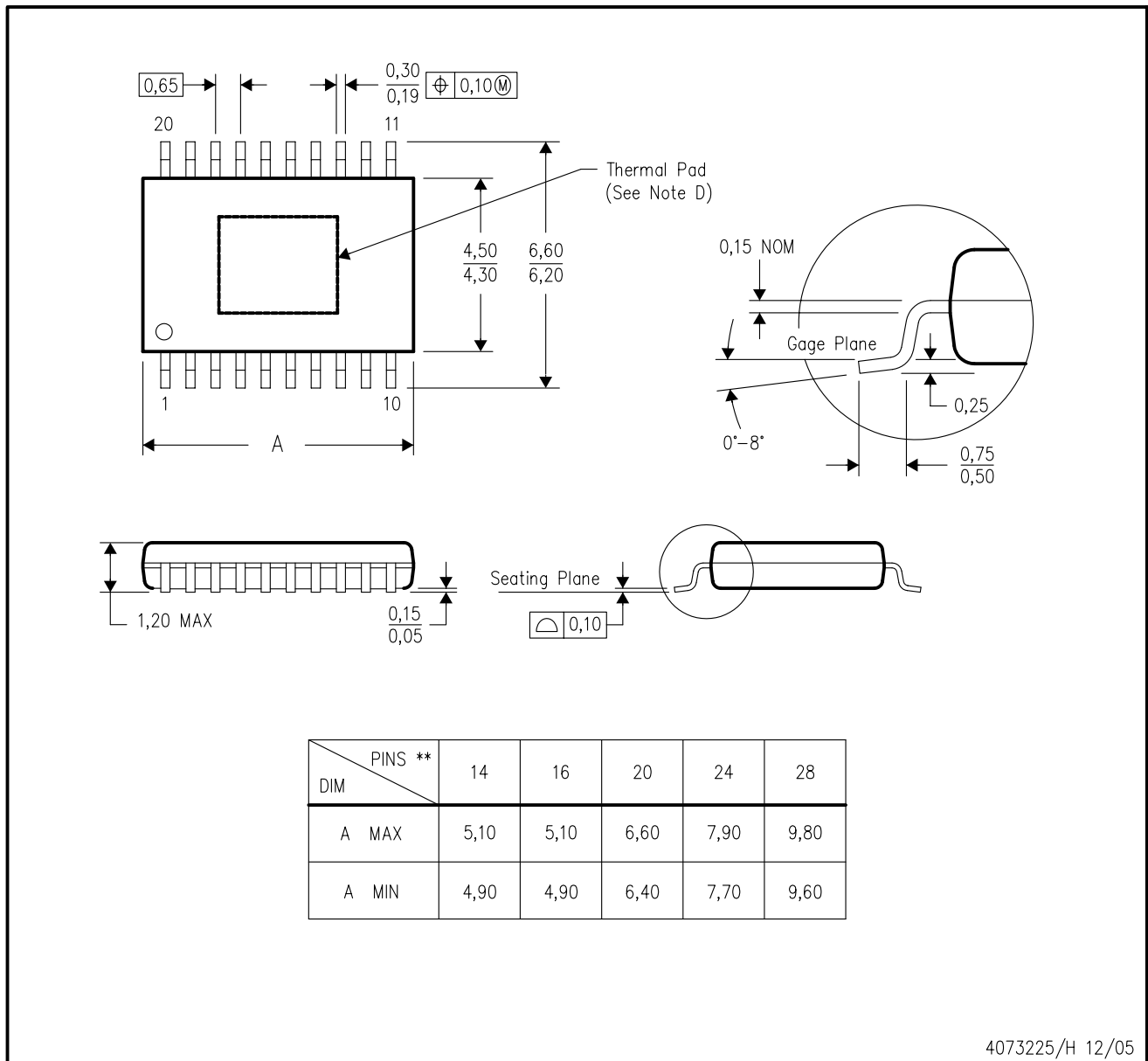

4073225/H 12/05

- NOTES:
- A. All linear dimensions are in millimeters.
  - B. This drawing is subject to change without notice.
  - C. Body dimensions do not include mold flash or protrusions. Mold flash and protrusion shall not exceed 0.15 per side.
  - D. This package is designed to be soldered to a thermal pad on the board. Refer to Technical Brief, PowerPad Thermally Enhanced Package, Texas Instruments Literature No. SLMA002 for information regarding recommended board layout. This document is available at [www.ti.com](http://www.ti.com) <<http://www.ti.com>>.
  - E. Falls within JEDEC MO-153

PowerPAD is a trademark of Texas Instruments.

THERMAL INFORMATION

This PowerPAD™ package incorporates an exposed thermal pad that is designed to be attached directly to an external heatsink. The thermal pad must be soldered directly to the printed circuit board (PCB). After soldering, the PCB can be used as a heatsink. In addition, through the use of thermal vias, the thermal pad can be attached directly to the appropriate copper plane shown in the electrical schematic for the device, or alternatively, can be attached to a special heatsink structure designed into the PCB. This design optimizes the heat transfer from the integrated circuit (IC).

For additional information on the PowerPAD package and how to take advantage of its heat dissipating abilities, refer to Technical Brief, PowerPAD Thermally Enhanced Package, Texas Instruments Literature No. SLMA002 and Application Brief, PowerPAD Made Easy, Texas Instruments Literature No. SLMA004. Both documents are available at [www.ti.com](http://www.ti.com).

The exposed thermal pad dimensions for this package are shown in the following illustration.

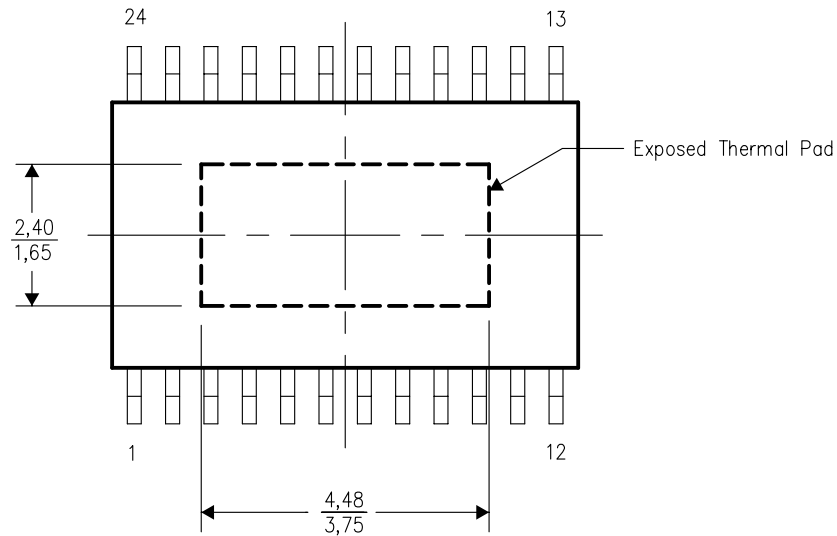

Top View

NOTE: All linear dimensions are in millimeters

Exposed Thermal Pad Dimensions

PWP (R-PDSO-G24) PowerPAD™

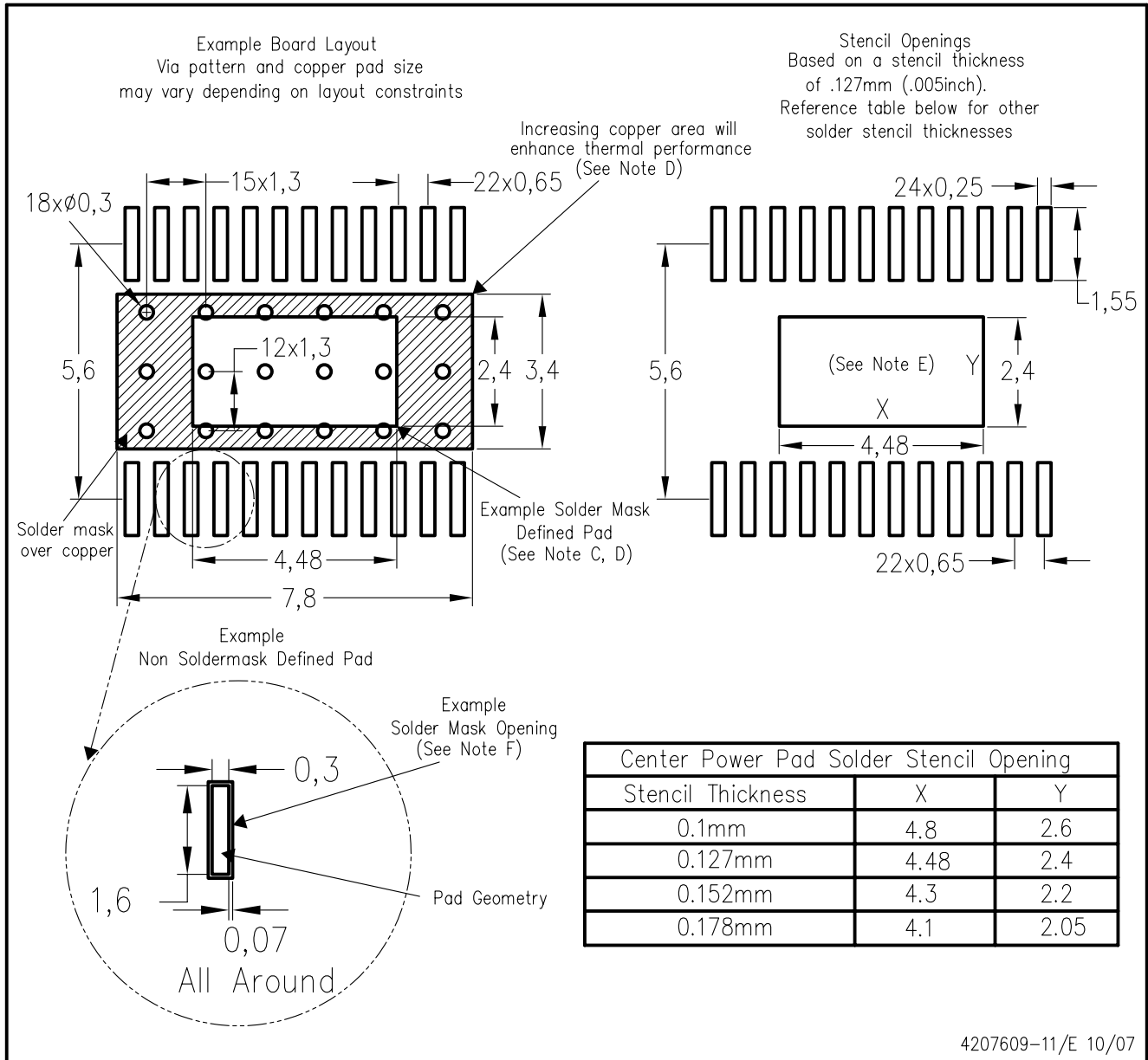

- NOTES:
- A. All linear dimensions are in millimeters.
  - B. This drawing is subject to change without notice.
  - C. Customers should place a note on the circuit board fabrication drawing not to alter the center solder mask defined pad.
  - D. This package is designed to be soldered to a thermal pad on the board. Refer to Technical Brief, PowerPad Thermally Enhanced Package, Texas Instruments Literature No. SLMA002, SLMA004, and also the Product Data Sheets for specific thermal information, via requirements, and recommended board layout. These documents are available at [www.ti.com](http://www.ti.com) <<http://www.ti.com>>. Publication IPC-7351 is recommended for alternate designs.
  - E. Laser cutting apertures with trapezoidal walls and also rounding corners will offer better paste release. Customers should contact their board assembly site for stencil design recommendations. Example stencil design based on a 50% volumetric metal load solder paste. Refer to IPC-7525 for other stencil recommendations.
  - F. Customers should contact their board fabrication site for solder mask tolerances between and around signal pads.

PowerPAD is a trademark of Texas Instruments.

## IMPORTANT NOTICE

Texas Instruments Incorporated and its subsidiaries (TI) reserve the right to make corrections, modifications, enhancements, improvements, and other changes to its products and services at any time and to discontinue any product or service without notice. Customers should obtain the latest relevant information before placing orders and should verify that such information is current and complete. All products are sold subject to TI's terms and conditions of sale supplied at the time of order acknowledgment.

TI warrants performance of its hardware products to the specifications applicable at the time of sale in accordance with TI's standard warranty. Testing and other quality control techniques are used to the extent TI deems necessary to support this warranty. Except where mandated by government requirements, testing of all parameters of each product is not necessarily performed.

TI assumes no liability for applications assistance or customer product design. Customers are responsible for their products and applications using TI components. To minimize the risks associated with customer products and applications, customers should provide adequate design and operating safeguards.

TI does not warrant or represent that any license, either express or implied, is granted under any TI patent right, copyright, mask work right, or other TI intellectual property right relating to any combination, machine, or process in which TI products or services are used. Information published by TI regarding third-party products or services does not constitute a license from TI to use such products or services or a warranty or endorsement thereof. Use of such information may require a license from a third party under the patents or other intellectual property of the third party, or a license from TI under the patents or other intellectual property of TI.

Reproduction of TI information in TI data books or data sheets is permissible only if reproduction is without alteration and is accompanied by all associated warranties, conditions, limitations, and notices. Reproduction of this information with alteration is an unfair and deceptive business practice. TI is not responsible or liable for such altered documentation. Information of third parties may be subject to additional restrictions.

Resale of TI products or services with statements different from or beyond the parameters stated by TI for that product or service voids all express and any implied warranties for the associated TI product or service and is an unfair and deceptive business practice. TI is not responsible or liable for any such statements.

TI products are not authorized for use in safety-critical applications (such as life support) where a failure of the TI product would reasonably be expected to cause severe personal injury or death, unless officers of the parties have executed an agreement specifically governing such use. Buyers represent that they have all necessary expertise in the safety and regulatory ramifications of their applications, and acknowledge and agree that they are solely responsible for all legal, regulatory and safety-related requirements concerning their products and any use of TI products in such safety-critical applications, notwithstanding any applications-related information or support that may be provided by TI. Further, Buyers must fully indemnify TI and its representatives against any damages arising out of the use of TI products in such safety-critical applications.

TI products are neither designed nor intended for use in military/aerospace applications or environments unless the TI products are specifically designated by TI as military-grade or "enhanced plastic." Only products designated by TI as military-grade meet military specifications. Buyers acknowledge and agree that any such use of TI products which TI has not designated as military-grade is solely at the Buyer's risk, and that they are solely responsible for compliance with all legal and regulatory requirements in connection with such use.

TI products are neither designed nor intended for use in automotive applications or environments unless the specific TI products are designated by TI as compliant with ISO/TS 16949 requirements. Buyers acknowledge and agree that, if they use any non-designated products in automotive applications, TI will not be responsible for any failure to meet such requirements.

Following are URLs where you can obtain information on other Texas Instruments products and application solutions:

### Products

Amplifiers	<a href="http://amplifier.ti.com">amplifier.ti.com</a>
Data Converters	<a href="http://dataconverter.ti.com">dataconverter.ti.com</a>
DSP	<a href="http://dsp.ti.com">dsp.ti.com</a>
Clocks and Timers	<a href="http://www.ti.com/clocks">www.ti.com/clocks</a>
Interface	<a href="http://interface.ti.com">interface.ti.com</a>
Logic	<a href="http://logic.ti.com">logic.ti.com</a>
Power Mgmt	<a href="http://power.ti.com">power.ti.com</a>
Microcontrollers	<a href="http://microcontroller.ti.com">microcontroller.ti.com</a>
RFID	<a href="http://www.ti-rfid.com">www.ti-rfid.com</a>
RF/IF and ZigBee® Solutions	<a href="http://www.ti.com/lprf">www.ti.com/lprf</a>

### Applications

Audio	<a href="http://www.ti.com/audio">www.ti.com/audio</a>
Automotive	<a href="http://www.ti.com/automotive">www.ti.com/automotive</a>
Broadband	<a href="http://www.ti.com/broadband">www.ti.com/broadband</a>
Digital Control	<a href="http://www.ti.com/digitalcontrol">www.ti.com/digitalcontrol</a>
Medical	<a href="http://www.ti.com/medical">www.ti.com/medical</a>
Military	<a href="http://www.ti.com/military">www.ti.com/military</a>
Optical Networking	<a href="http://www.ti.com/opticalnetwork">www.ti.com/opticalnetwork</a>
Security	<a href="http://www.ti.com/security">www.ti.com/security</a>
Telephony	<a href="http://www.ti.com/telephony">www.ti.com/telephony</a>
Video & Imaging	<a href="http://www.ti.com/video">www.ti.com/video</a>
Wireless	<a href="http://www.ti.com/wireless">www.ti.com/wireless</a>

Mailing Address: Texas Instruments, Post Office Box 655303, Dallas, Texas 75265  
Copyright © 2008, Texas Instruments Incorporated