

	<h1>TS1084</h1> <h2>5A Low Dropout Positive Voltage Regulator</h2>												
<p><b>TO-220</b></p>  <p>1 2 3</p>	<p><b>TO-263</b></p>  <p>1 2 3</p>	<p><b>TO-252</b></p>  <p>1 3</p> <p>Pin assignment:</p> <ol style="list-style-type: none"> <li>1. Ground / Adj</li> <li>2. Output</li> <li>3. Input</li> </ol>	<h3>Low Dropout Voltage 1.3V max.</h3>										
<h3>General Description</h3> <p>The TS1084 Series are high performance positive voltage regulators are designed for use in applications requiring low dropout performance at full rated current, Additionally, the PJ1084 Series provides excellent regulation over variations due to changes in line, load and temperature. Outstanding features include low dropout performance at rated current, fast transient response, internal current limiting and thermal shutdown protection of the output device. The TS1084 Series are three terminal regulators with fixed and adjustable voltage options available in popular packages. This series is offered in 3-pin TO-263, TO-220 and TO-252 package.</p>													
<h3>Features</h3> <ul style="list-style-type: none"> <li>◇ Low dropout performance 1.3V max.</li> <li>◇ Full current rating over line and temperature.</li> <li>◇ Fast transient response</li> <li>◇ ±2% Total output regulation over line, load and temperature</li> <li>◇ Adjust pin current max 90µA over temperature</li> <li>◇ Line regulation typical 0.015%.</li> <li>◇ Load regulation typical 0.05%.</li> <li>◇ Fixed/adjustable output voltage</li> <li>◇ TO-220, TO-263 and TO-252 package</li> </ul>													
<h3>Block Diagram</h3> 		<h3>Ordering Information</h3> <table border="1" data-bbox="857 1255 1401 1451"> <thead> <tr> <th>Part No.</th> <th>Operating Temp. (Ambient)</th> <th>Package</th> </tr> </thead> <tbody> <tr> <td>TS1084CZ-xx</td> <td rowspan="3" style="text-align: center;">-20 ~ +85 °C</td> <td>TO-220</td> </tr> <tr> <td>TS1084CM-xx</td> <td>TO-263</td> </tr> <tr> <td>TS1084CP-xx</td> <td>TO-252</td> </tr> </tbody> </table> <p>Note: Where xx denotes voltage option, available are 5.0V, 3.3V and 2.5V. Leave blank for adjustable version. Contact factory for additional voltage options.</p>		Part No.	Operating Temp. (Ambient)	Package	TS1084CZ-xx	-20 ~ +85 °C	TO-220	TS1084CM-xx	TO-263	TS1084CP-xx	TO-252
Part No.	Operating Temp. (Ambient)	Package											
TS1084CZ-xx	-20 ~ +85 °C	TO-220											
TS1084CM-xx		TO-263											
TS1084CP-xx		TO-252											
<h3>Absolute Maximum Rating</h3>													
Input Supply Voltage	Vin	12	V										
Operation Input Supply Voltage	Vin (operate)	7	V										
Power Dissipation	PD	Internally Limited	W										
Operating Junction Temperature Range	TJ	-25 ~ +150	°C										
Storage Temperature Range	TSTG	-65 ~ +150	°C										
Lead Soldering Temperature (260 °C)	TO-220 / TO-263 Package TO-252 Package	10 5	S										





## Electrical Characteristics

Ta = 25 °C, unless otherwise specified. Adjustable version test with Vout = 2.5V.

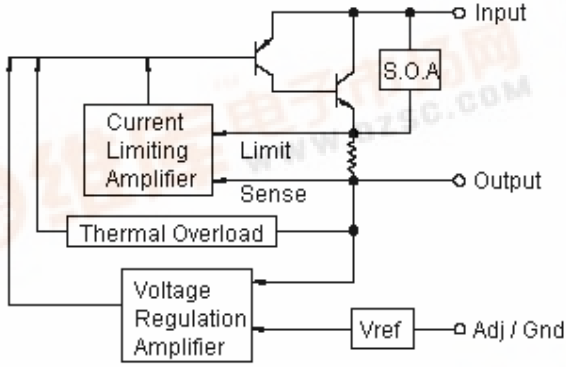
Parameter	Conditions	Min	Typ	Max	Unit
Output Voltage	Vout+1.5V ≤ Vin ≤ 7V, Io=10mA	0.990 Vo	5.0 / 3.3	1.010 Vo	V
	Vout+1.5V ≤ Vin ≤ 7V, Io=5A	0.980 Vo	2.5	1.020 Vo	V
Reference Voltage	(Vin-out) =1.5V, Io=10mA	0.990 Vo	1.25	1.010 Vo	V
	(Vin-out) =1.5V, Io=5A	0.980 Vo		1.020 Vo	V
Input Supply Voltage		--	--	7	V
Line Regulation	Vout+1.5V ≤ Vin ≤ 7V, Io=10mA	--	0.015	0.2	%
Load Regulation (note 1,2)	Vin=Vout+1.5V, 10mA ≤ Io ≤ 5A	--	0.05	1.0	%
					%
Dropout Voltage	Io=5A, ΔVout=0.1%Vout	--	1.2	1.3	V
Minimum Load Current	Vin=5V	--	8	10	mA
Adjustable Pin Current		--	90	--	uA
Current Limit	Vin - Vout=3V	5.5	--	--	A
Temperature Stability	Io=10mA	--	0.5	--	%
Ripple Rejection	F = 120Hz, Io=5A Cout=25uF, Vin=Vout + 3V	--	60	70	dB

## Thermal Performance

Condition	Package type	Typ	Unit
Thermal Resistance Junction to Ambient	TO-220	45	°C/W
	TO-263	45	
	TO-252	80	

Note 1: See thermal regulation specification for changes in output voltage due to heating effects. Line and load regulation are measured at a constant junction temperature by low duty cycle pulse testing. Load regulation is measured at the output lead = 1/18" from the package.

Note 2: Line and load regulation are guaranteed up to the maximum power dissipation of 15W. Power dissipation is determined by the input / output voltage difference and the output current. Guaranteed maximum power dissipation will not be available over the full input / output voltage range.

Note 3: Quiescent current is defined as the minimum output current required to maintain the regulation.



## Typical Application Circuit

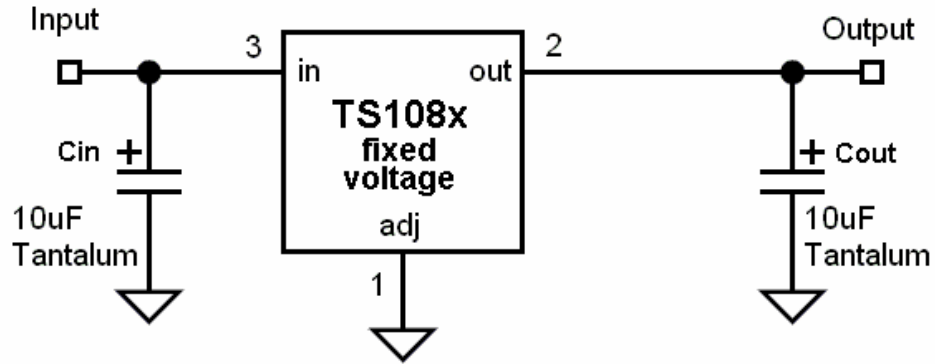

Fixed output voltage version

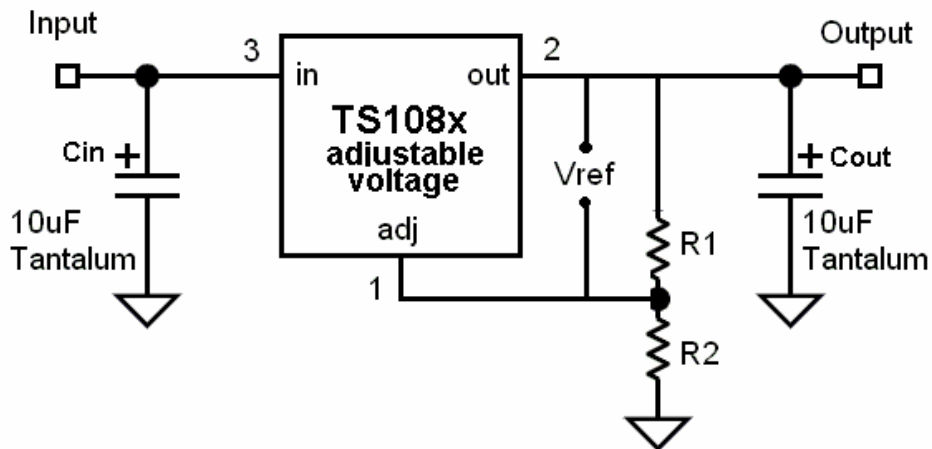

$$V_{out} = V_{ref} * (1 + R2 / R1)$$

\* Cin is requested if regulator is located

Far from power supply filter

\*\* Design Cout as close to Vout pin as possible

Adjustable output voltage version



## Electrical Characteristics Curve

Figure 1: dropout voltage v.s. output current

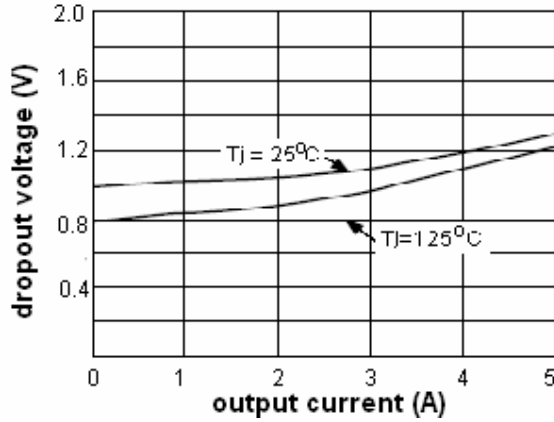

Figure 2: load regulation v.s. temp.

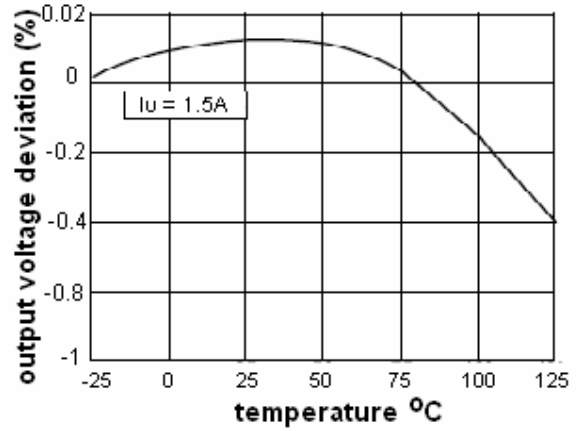

Figure 3: output change v.s. temp.

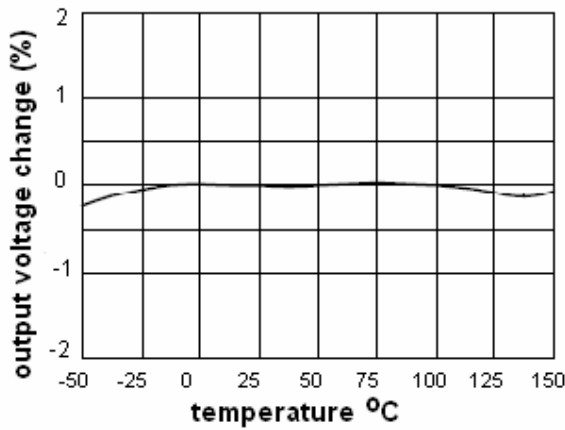

Figure 4: line regulation

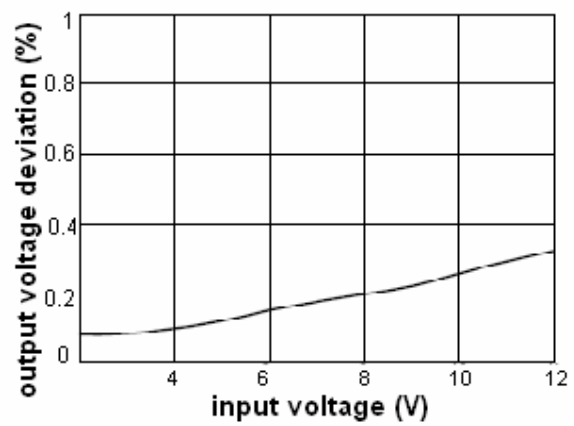

Figure 5: line transient response

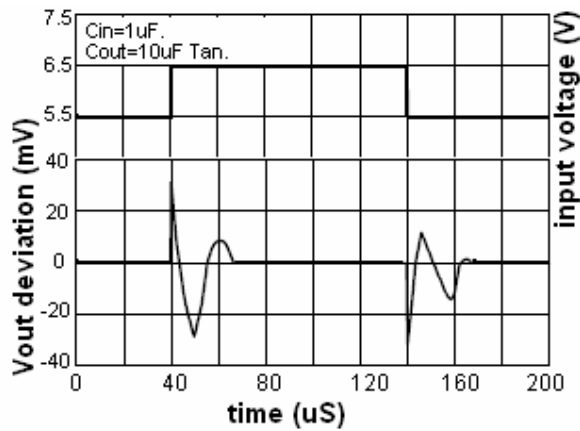
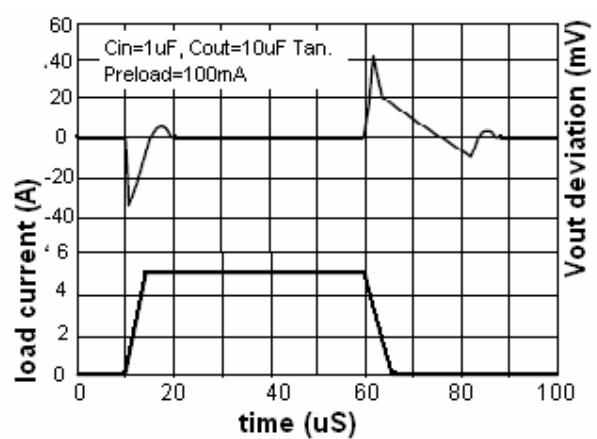
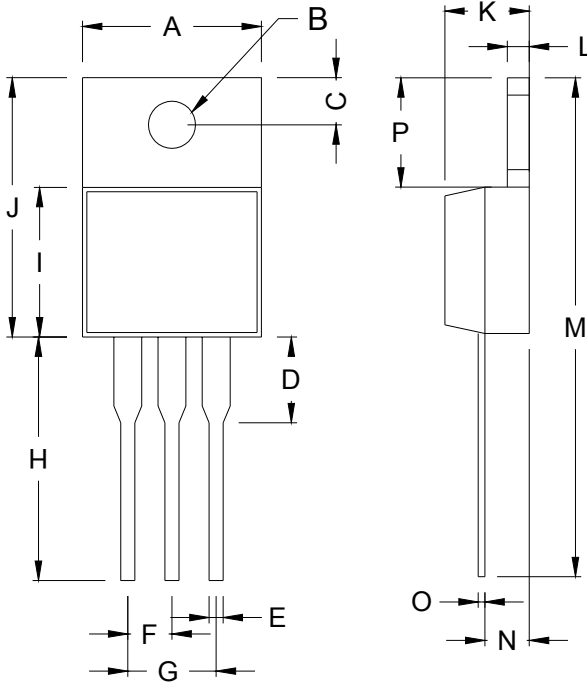

Figure 6: load transient response



## TO-220 Mechanical Drawing



DIM	TO-220 DIMENSION			
	MILLIMETERS		INCHES	
	MIN	MAX	MIN	MAX
A	10.000	10.500	0.394	0.413
B	3.240	4.440	0.128	0.175
C	2.440	2.940	0.096	0.116
D	-	6.350	-	0.250
E	0.381	1.106	0.015	0.040
F	2.345	2.715	0.092	0.058
G	4.690	5.430	0.092	0.107
H	12.700	14.732	0.500	0.581
I	8.382	9.017	0.330	0.355
J	14.224	16.510	0.560	0.650
K	3.556	4.826	0.140	0.190
L	0.508	1.397	0.020	0.055
M	27.700	29.620	1.060	1.230
N	2.032	2.921	0.080	0.115
O	0.255	0.610	0.010	0.024
P	5.842	6.858	0.230	0.270

## TO-263 Mechanical Drawing

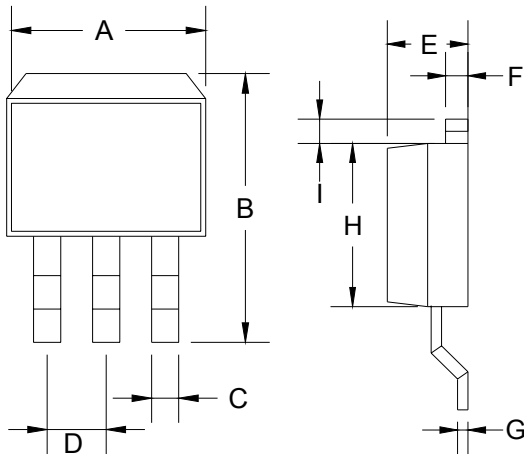

DIM	TO-263 DIMENSION			
	MILLIMETERS		INCHES	
	MIN	MAX	MIN	MAX
A	10.000	10.500	0.394	0.413
B	14.605	15.875	0.575	0.625
C	0.508	0.991	0.020	0.039
D	2.420	2.660	0.095	0.105
E	4.064	4.830	0.160	0.190
F	1.118	1.400	0.045	0.055
G	0.450	0.730	0.018	0.029
H	8.280	8.800	0.325	0.346
I	1.140	1.400	0.044	0.055
J	1.480	1.520	0.058	0.060

## TO-252 Mechanical Drawing

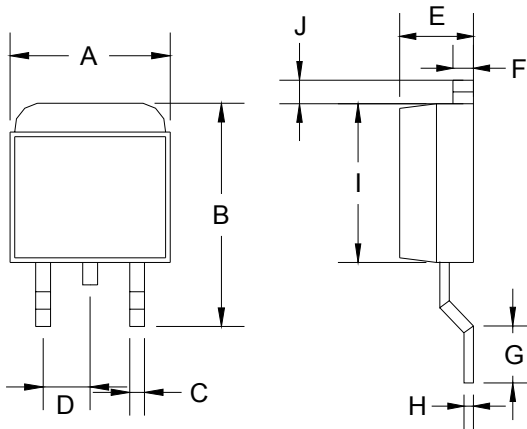

DIM	TO-252 DIMENSION			
	MILLIMETERS		INCHES	
	MIN	MAX	MIN	MAX
A	6.570	6.840	0.259	0.269
B	9.250	10.400	0.364	0.409
C	0.550	0.700	0.022	0.028
D	2.560	2.670	0.101	0.105
E	2.300	2.390	0.090	0.094
F	0.490	0.570	0.019	0.022
G	1.460	1.580	0.057	0.062
H	0.520	0.570	0.020	0.022
I	5.340	5.550	0.210	0.219
J	1.460	1.640	0.057	0.065