

TS 135 → TS 1235
THYRISTORS

T-25-17

General purpose SCR suited for power supplies up to 400 Hz on resistive or inductive loads.

- V_{RRM} up to 1 200 V.
- Glass passivated chips.
- High stability and reliability.

Thyristors à usage général, pour des alimentations jusqu'à 400 Hz sur charges résistives ou inductives.

- V_{RRM} jusqu'à 1 200 V.
- Pastilles glassivées.
- Grande stabilité des caractéristiques.

$I_T(RMS) = 35 \text{ A} / T_{case} = 75^\circ\text{C}$

$100 \text{ V} \leq \begin{matrix} V_{DRM} \\ = \\ V_{RRM} \end{matrix} \leq 1\,200 \text{ V}$

Case : TO 48 metal (CB-267)
Boîtier

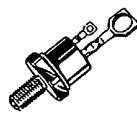

ABSOLUTE RATINGS (LIMITING VALUES) VALEURS LIMITES ABSOLUES D'UTILISATION	Symbol	Value	Unit
RMS on-state current* <i>Courant efficace à l'état passant*</i>	$I_T(RMS)$	35 @ $T_{case} = 75^\circ\text{C}$	A
Mean on-state current* <i>Courant moyen à l'état passant*</i>	$I_T(AV)$	22,5 @ $T_{case} = 75^\circ\text{C}$	A
Non repetitive surge peak on-state current** <i>Courant non répétitif de surcharge crête accidentelle à l'état passant**</i>	I_{TSM} I_{TSM}	360 (t = 8,3 ms) 330 (t = 10 ms) @ $T_j \leq 125^\circ\text{C}$	A A
$i^2 t$ for fusing <i>Valeur de la constante $i^2 t$</i>	$i^2 t$	545 (t = 10 ms) @ $T_j \leq 125^\circ\text{C}$	A ² s
Critical rate of rise of on-state current*** <i>Vitesse critique de croissance du courant à l'état passant***</i>	di/dt	100	A/ μ s
Storage and operating junction temperatures <i>Températures extrêmes de stockage et de jonction en fonctionnement</i>	T_{stg} T_j	-40 , + 150 -40 , + 125	$^\circ\text{C}$ $^\circ\text{C}$

@ $T_j = 125^\circ\text{C}$	TS 135	TS 235	TS 435	TS 635	TS 835	TS 1035	TS 1235
$V_{DRM} = V_{RRM} \text{ (V)}$	100	200	400	600	800	1000	1200

Thermal resistances <i>Résistances thermiques</i>	Symbol	Value	Unit
— Junction to case for D.C. <i>Jonction-boîtier en continu</i>	$R_{th(j-c)}$	1,1	$^\circ\text{C}/\text{W}$
— Contact (case to heatsink) <i>Contact (boîtier-radiateur)</i>	$R_{th(c-h)}$	0,4	$^\circ\text{C}/\text{W}$

* Single phase circuit, 180° conduction angle
* Circuit monophasé, angle de conduction 180°

** Half sine wave
** Demi-onde sinusoïdale

*** Gate supply 20 V/20 Ω - tr \leq 0,1 μ s - Half sine wave of 6,3 μ s
*** Générateur de gâchette Demi-sinusoidale

May 1984 - 1/5



GATE CHARACTERISTICS (Maximum values)
CARACTÉRISTIQUES DE GÂCHETTE (Valeurs maximales)

$P_{GM} = 60\text{ W}$ ($t = 500\ \mu\text{s}$)
 $P_{G(AV)} = 1\text{ W}$

$I_{FGM} = 10\text{ A}$ ($t = 500\ \mu\text{s}$)
 $V_{FGM} = 15\text{ V}$ ($t = 500\ \mu\text{s}$)

$V_{RGM} = 5\text{ V}$

ELECTRICAL CHARACTERISTICS
CARACTÉRISTIQUES ÉLECTRIQUES

Symbol	Value			Unit	Test conditions			
	min	typ	max					
I_{GT}			80	mA	$T_J = 25^\circ\text{C}$	$V_D = 12\text{ V}$	$R_L = 33\ \Omega$	$t_p \geq 20\ \mu\text{s}$
V_{GT}			3	V	$T_J = 25^\circ\text{C}$	$V_D = 12\text{ V}$	$R_L = 33\ \Omega$	$t_p \geq 20\ \mu\text{s}$
V_{GD}	0,2			V	$T_J = 125^\circ\text{C}$	$V_D = V_{DRM}$	$R_L = 3,3\ \text{k}\Omega$	
I_H		20		mA	$T_J = 25^\circ\text{C}$	$I_T = 0,5\text{ A}$	Gate open	
V_{TM}			2,2	V	$T_J = 25^\circ\text{C}$	$I_{TM} = 70\text{ A}$	$t_p = 10\text{ ms}$	
I_{DRM}			3,3	mA	$T_J = 125^\circ\text{C}$	V_{DRM} specified		
I_{RRM}			3,3	mA	$T_J = 125^\circ\text{C}$	V_{RRM} specified		
t_{gt}		2		μs	$T_J = 25^\circ\text{C}$ $I_G = 200\text{ mA}$	$I_T = 70\text{ A}$ $di_G/dt = 2\text{ A}/\mu\text{s}$	$V_D = V_{DRM}$	
t_q		100		μs	$T_J = 125^\circ\text{C}$ $di_R/dt = 30\text{ A}/\mu\text{s}$	$I_T = 10\text{ A}$ $dv/dt = 20\text{ V}/\mu\text{s}$	$V_R = 30\text{ V}$	$V_D = 0,67 V_{DRM}$ Gate open
dv/dt^*	100			$\text{V}/\mu\text{s}$	$T_J = 125^\circ\text{C}$	Linear slope up to $0,67 V_{DRM}$ specified		Gate open

* For higher guaranteed values, please consult us.

CASE DESCRIPTION
DESCRIPTION DU BOITIER

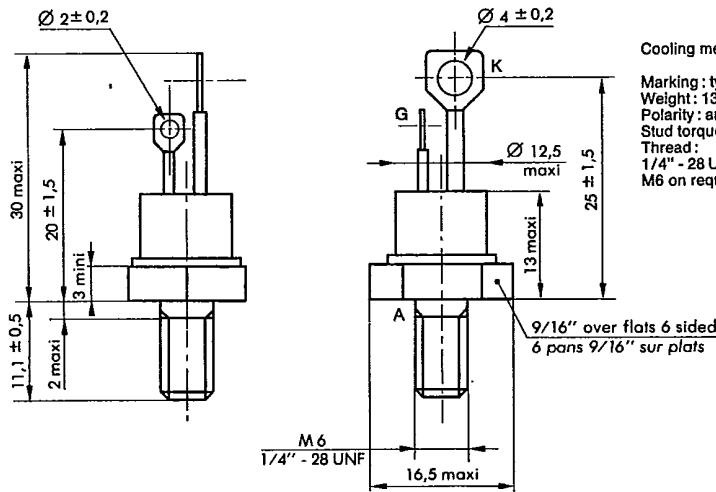

Cooling method: by conduction (method C)
 Marking: type number
 Weight: $13,5 \pm 1\text{ g}$
 Polarity: anode to case
 Stud torque: $3,5\text{ m}\ \wedge\ \text{Nmin} - 3,8\text{ m}\ \wedge\ \text{Nmax}$
 Thread:
 $1/4'' - 28\text{ UNF}$: type N°
 M6 on request: type N° + suffix M

TO 48 metal (CB-267)

T-25-17

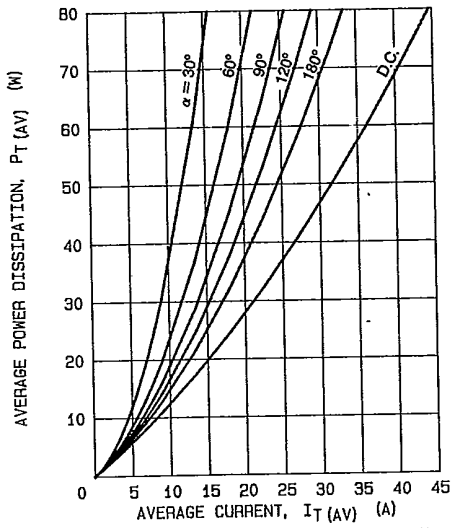
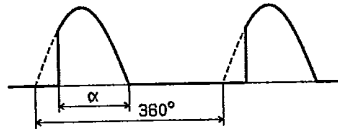

FIG.1 - MAXIMUM ON-STATE POWER DISSIPATION FOR SINUSOIDAL CURRENT WAVEFORM

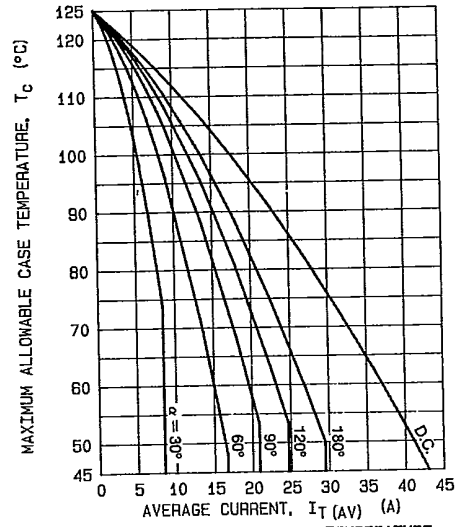

FIG.2 - MAXIMUM ALLOWABLE CASE TEMPERATURE FOR SINUSOIDAL CURRENT WAVEFORM

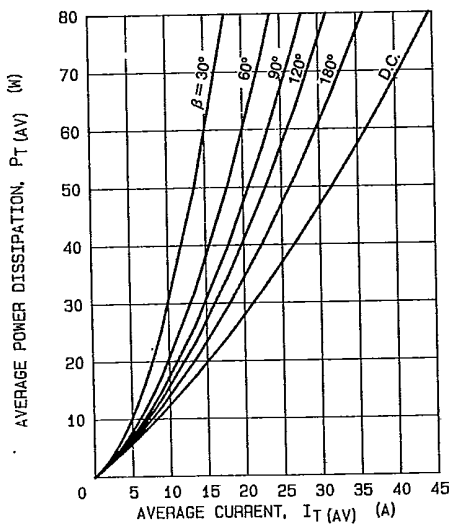
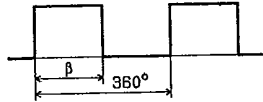

FIG.3 - MAXIMUM ON-STATE POWER DISSIPATION FOR RECTANGULAR CURRENT WAVEFORM

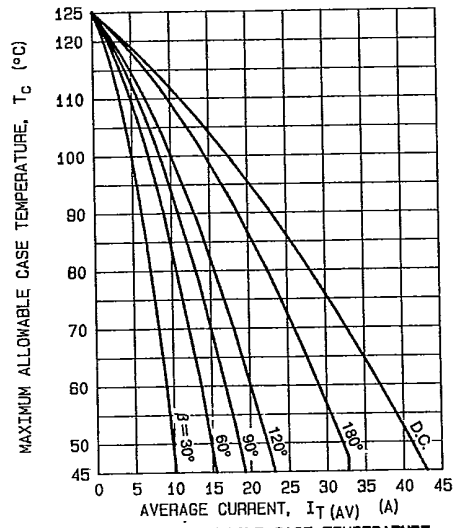

FIG.4 - MAXIMUM ALLOWABLE CASE TEMPERATURE FOR RECTANGULAR CURRENT WAVEFORM

T-25-17

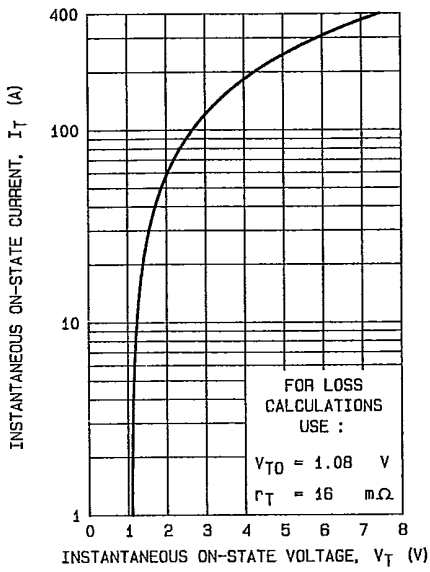

FIG.5 - MAXIMUM ON-STATE CONDUCTION CHARACTERISTIC ($T_J = 125^\circ\text{C}$).

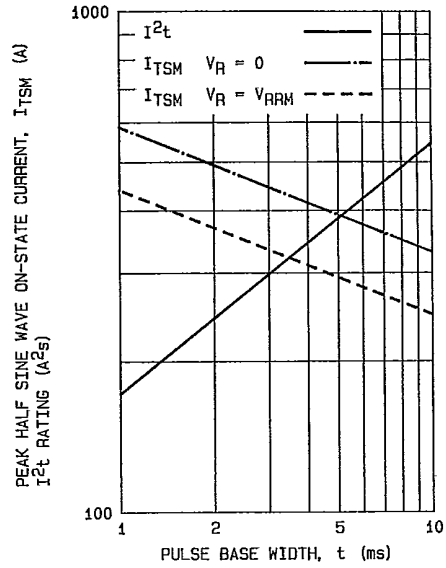

FIG.8 - NON REPETITIVE SUB-CYCLE SURGE ON-STATE CURRENT AND I^2t RATING (INITIAL $T_J = 125^\circ\text{C}$).

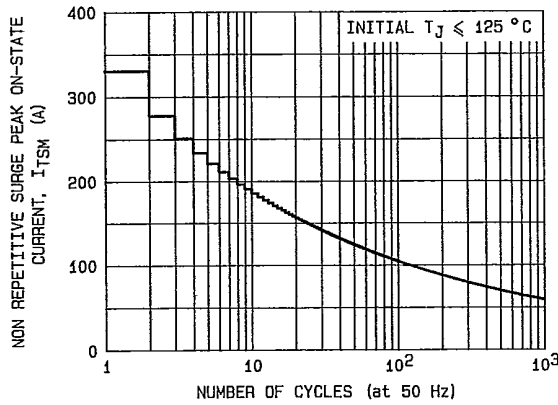

FIG.7 - NON REPETITIVE SURGE PEAK ON-STATE CURRENT VERSUS NUMBER OF CYCLES.

T.25-17

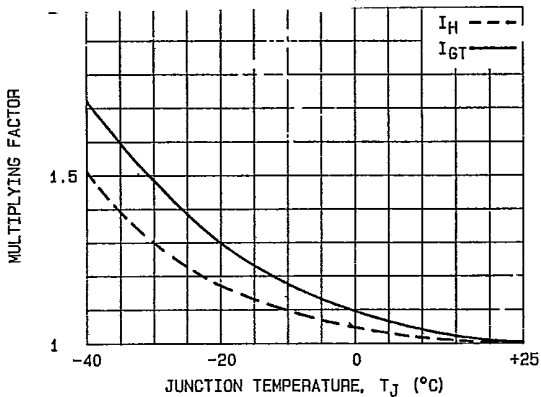

FIG.8 - RELATIVE VARIATION OF GATE TRIGGER CURRENT AND HOLDING CURRENT VERSUS JUNCTION TEMPERATURE.

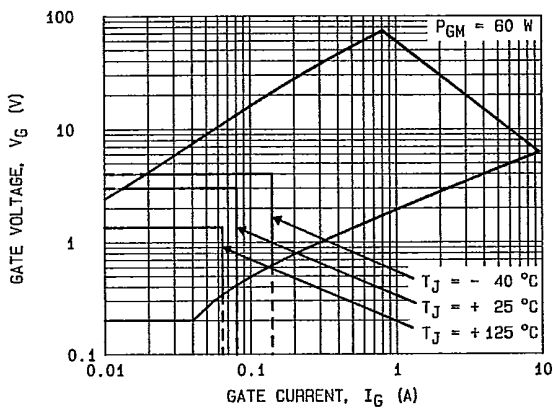
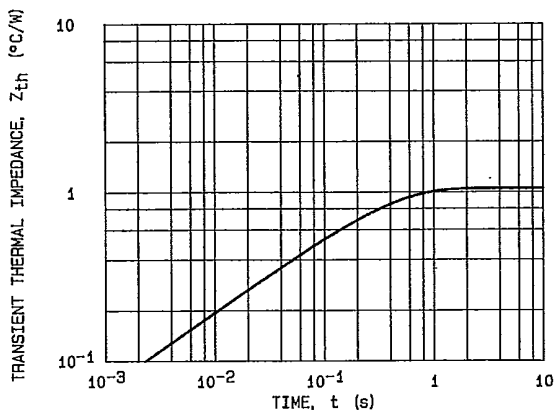

FIG.9 - GATE TRIGGER CHARACTERISTICS.



Conduction angle (α, β)	Effective thermal resistance ($^{\circ}\text{C}/\text{W}$) junction to case	
	Sinusoidal	Rectangular
180 $^{\circ}$	1.13	1.17
120 $^{\circ}$	1.23	1.65
90 $^{\circ}$	1.32	1.87
60 $^{\circ}$	1.54	2.09
30 $^{\circ}$	1.98	2.64

FIG.10 - TRANSIENT THERMAL IMPEDANCE JUNCTION TO CASE.

Copyright © Each Manufacturing Company.

All Datasheets cannot be modified without permission.

This datasheet has been download from :

www.AllDataSheet.com

100% Free DataSheet Search Site.

Free Download.

No Register.

Fast Search System.

www.AllDataSheet.com