

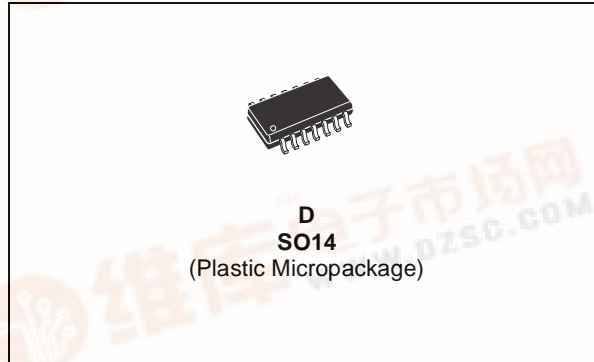

TSH93

HIGH SPEED LOW POWER TRIPLE OPERATIONAL AMPLIFIER

- LOW SUPPLY CURRENT : 4.5mA
- HIGH SPEED : 150MHz - 110V/μs
- UNITY GAIN STABILITY
- LOW OFFSET VOLTAGE : 4mV
- LOW NOISE 4.2 nV/√Hz
- LOW COST
- SPECIFIED FOR 600Ω AND 150Ω LOADS
- HIGH VIDEO PERFORMANCES :
 - Differential Gain : 0.03%
 - Differential Phase : 0.07°
 - Gain Flatness : 6MHz, 0.1dB max. @ 10dB gain
- HIGH AUDIO PERFORM
- ESD TOLERANCE : 2kV



DESCRIPTION

The TSH93 is a triple low power high frequency op-amp, designated for high quality video signal processing. The device offers an excellent speed consumption ratio with 4.5mA per amplifier for 150MHz bandwidth.

High slew rate and low noise make it also suitable for high quality audio applications.

ORDER CODE

Part Number	Temperature Range	Package
		D
TSH93I	-40°C, +125°C	•

D = Small Outline Package (SO) - also available in Tape & Reel (DT)

PIN CONNECTIONS (top view)

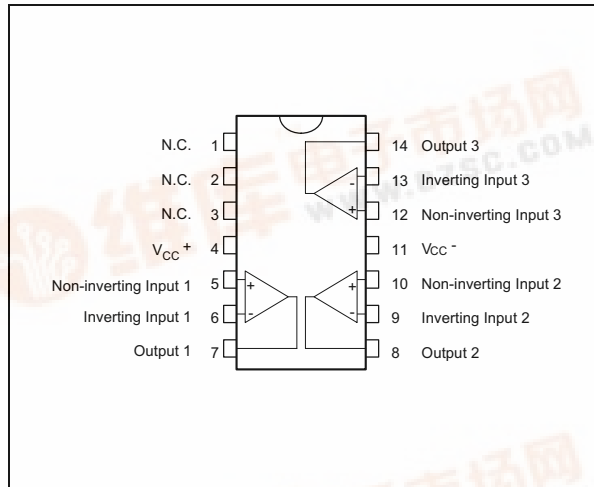

TSH93

SCHEMATIC DIAGRAM (1/3)

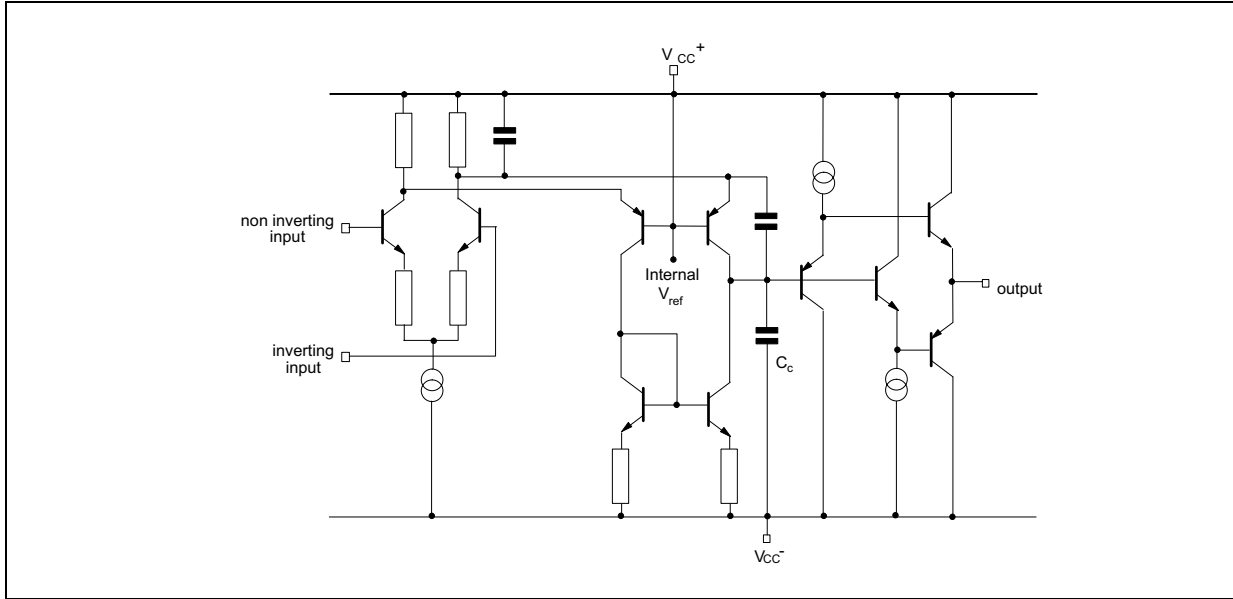

MAXIMUM RATINGS

Symbol	Parameter	Value	Unit
V_{CC}	Supply Voltage ¹⁾	14	V
V_{id}	Differential Input Voltage ²⁾	± 5	V
V_i	Input Voltage ³⁾	-0.3 to 12	V
T_{oper}	Operating Free-Air Temperature range	-40 to +125	$^{\circ}\text{C}$
T_{stg}	Storage Temperature Range	-65 to +150	$^{\circ}\text{C}$

1. All voltages values, except differential voltage are with respect to network ground terminal
2. Differential voltages are the non-inverting input terminal with respect to the inverting input terminal
3. The magnitude of input and output voltages must never exceed $V_{CC}^+ + 0.3\text{V}$

OPERATING CONDITIONS

Symbol	Parameter	Value	Unit
V_{CC}	Supply Voltage	7 to 12	V
V_{ic}	Common Mode Input Voltage Range	$V_{CC}^- + 2$ to $V_{CC}^+ - 1$	V

ELECTRICAL CHARACTERISTICS
 $V_{CC}^+ = 5V, V_{CC}^- = -5V, T_{amb} = 25^\circ C$ (unless otherwise specified)

Symbol	Parameter	Min.	Typ.	Max.	Unit
V_{io}	Input Offset Voltage $T_{min} \leq T_{amb} \leq T_{max}$.			4 6	mV
I_{io}	Input Offset Current $T_{min} \leq T_{amb} \leq T_{max}$.		1	2 5	μA
I_{ib}	Input Bias Current $T_{min} \leq T_{amb} \leq T_{max}$.		5	15 20	μA
I_{CC}	Supply Current (per amplifier, no load) $T_{min} \leq T_{amb} \leq T_{max}$.		4.5	6 8	mA
CMR	Common-mode Rejection Ratio $V_{ic} = -3V$ to $+4V, V_o = 0V$ $T_{min} \leq T_{amb} \leq T_{max}$.	80 70	100		dB
SVR	Supply Voltage Rejection Ratio $V_{CC} = \pm 5V$ to $\pm 3V$ $T_{min} \leq T_{amb} \leq T_{max}$.	60 50	75		dB
A_{vd}	Large Signal Voltage Gain $R_L = 100\Omega, V_o = \pm 2.5V$ $T_{min} \leq T_{amb} \leq T_{max}$.	57 54	70		dB
V_{OH}	High Level Output Voltage $V_{id} = 1V$ $T_{min} \leq T_{amb} \leq T_{max}$. $R_L = 600\Omega$ $R_L = 150\Omega$ $R_L = 150\Omega$	3 2.5 2.4	3.5 3		V
V_{OL}	Low Level Output Voltage $V_{id} = 11V$ $T_{min} \leq T_{amb} \leq T_{max}$. $R_L = 600\Omega$ $R_L = 150\Omega$ $R_L = 150\Omega$		-3.5 -2.8	-3 -2.5 -2.4	V
I_o	Output Short Circuit Current $V_{id} = \pm 1V$ $T_{min} \leq T_{amb} \leq T_{max}$. Source Sink Source Sink	20 20 15 15	36 40		mA
GBP	Gain Bandwidth Product $A_{VCL} = 100, R_L = 600\Omega, C_L = 15pF, f = 7.5MHz$	90	150		MHz
f_T	Transition Frequency		90		MHz
SR	Slew Rate $V_{in} = -2$ to $+2V, A_{VCL} = +1, R_L = 600\Omega, C_L = 15pF$	62	110		V/ μs
e_n	Equivalent Input Voltage Noise $R_s = 50\Omega, f = 1kHz$		4.2		nV/ \sqrt{Hz}
ϕ_m	Phase Margin $A_{VM} = +1$		35		Degrees
V_{O1}/V_{O2}	Channel Separation $f = 1MHz$ to $10MHz$		65		dB
Gf	Gain Flatness $f = DC$ to $6MHz, A_{VCL} = 10dB$			0.1	dB
THD	Total Harmonic Distortion $f = 1kHz, V_o = \pm 2.5V, R_L = 600\Omega$		0.01		%
ΔG	Differential Gain $f = 3.58MHz, A_{VCL} = +2, R_L = 150\Omega$		0.03		%
$\Delta\phi$	Differential Phase $f = 3.58MHz, A_{VCL} = +2, R_L = 150\Omega$		0.07		Degree

PRINTED CIRCUIT LAYOUT

As for any high frequency device, a few rules must be observed when designing the PCB to get the best performances from this high speed op amp.

From the most to the least important points :

- Each power supply lead has to be bypassed to ground with a 10nF ceramic capacitor very close to the device and a 10μF capacitor.
- To provide low inductance and low resistance common return, use a ground plane or common point return for power and signal.
- All leads must be wide and as short as possible especially for op amp inputs. This is in order to decrease parasitic capacitance and inductance.
- Use small resistor values to decrease time constant with parasitic capacitance.
- Choose component sizes as small as possible (SMD).

On output, decrease capacitor load so as to avoid circuit stability being degraded which may cause oscillation. You can also add a serial resistor in order to minimise its influence.

INPUT OFFSET VOLTAGE DRIFT VERSUS TEMPERATURE

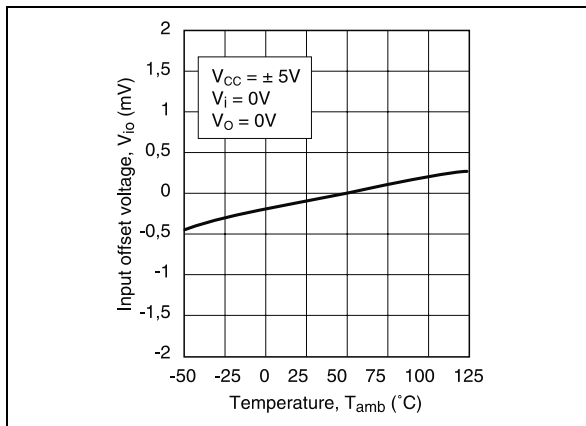

STATIC OPEN LOOP VOLTAGE GAIN

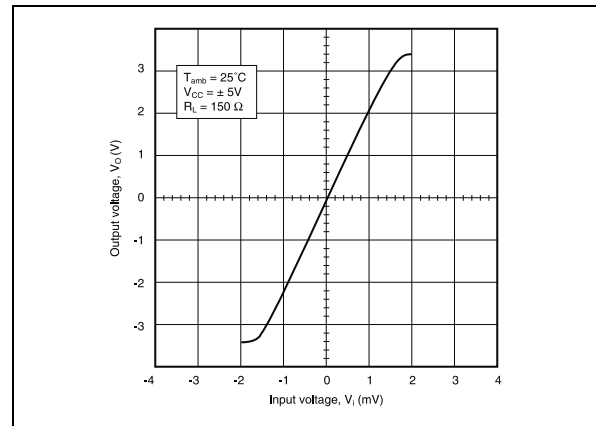

LARGE SIGNAL FOLLOWER RESPONSE

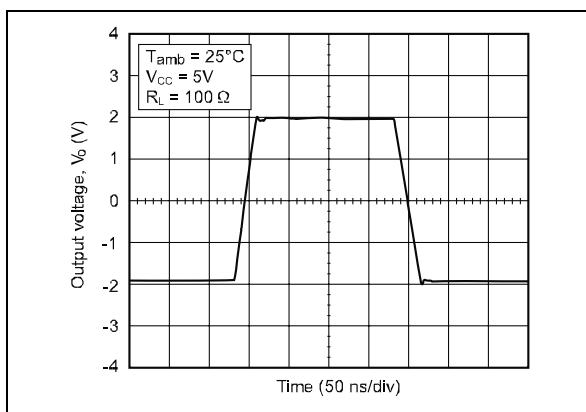

SMALL SIGNAL FOLLOWER RESPONSE

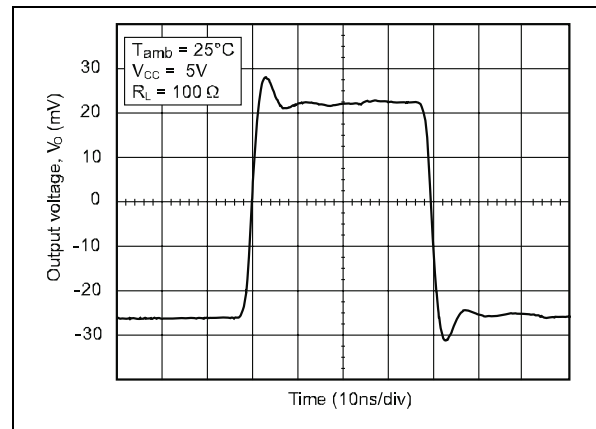

OPEN LOOP FREQUENCY RESPONSE AND PHASE SHIFT

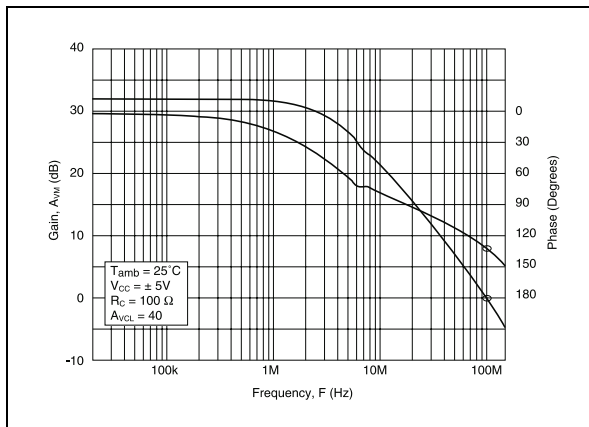

CLOSE LOOP FREQUENCY RESPONSE

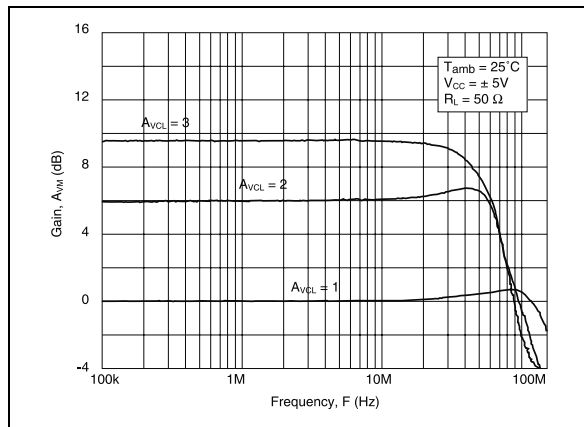

AUDIO BANDWIDTH FREQUENCY RESPONSE AND PHASE SHIFT (TSH93 vs Standard 15MHz Audio Op-Amp)

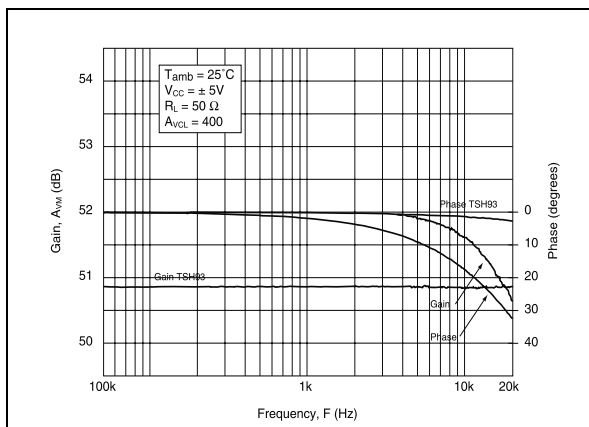

GAIN FLATNESS AND PHASE SHIFT VERSUS FREQUENCY

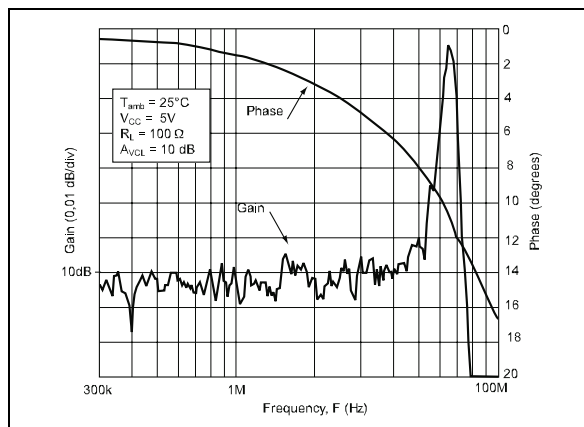

CROSS TALK ISOLATION VERSUS FREQUENCY (SO14 PACKAGE)

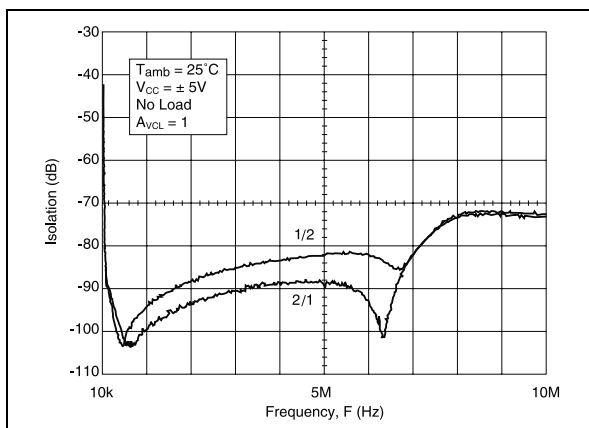

CROSS TALK ISOLATION VERSUS FREQUENCY (SO14 PACKAGE)

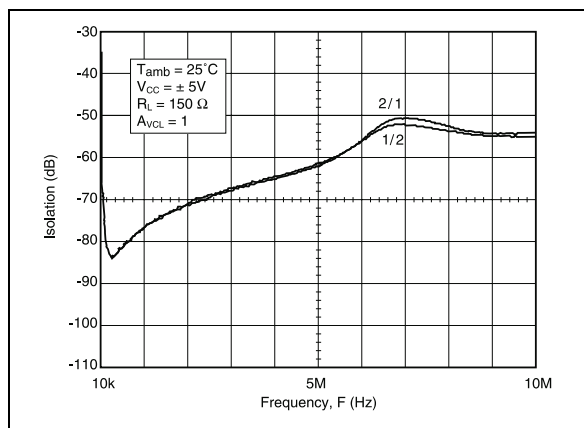

DIFFERENTIAL INPUT IMPEDANCE VERSUS FREQUENCY

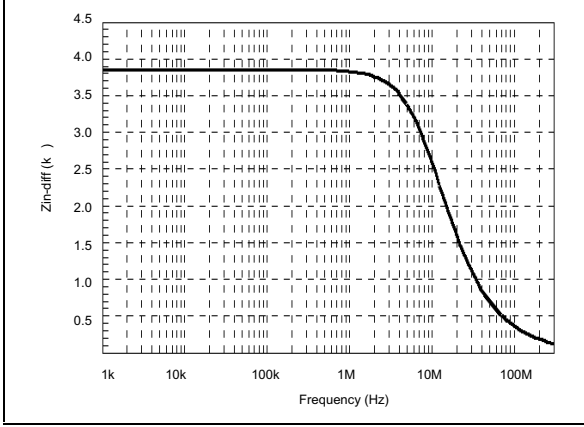

COMMON INPUT IMPEDANCE VERSUS FREQUENCY

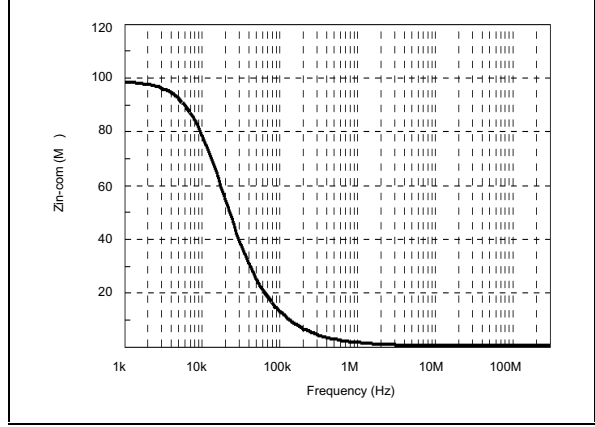

MACROMODEL**Applies to: TSH93I**

```

** Standard Linear Ics Macromodels, 1997.
** CONNECTIONS :
* 1 INVERTING INPUT
* 2 NON-INVERTING INPUT
* 3 OUTPUT
* 4 POSITIVEPOWER SUPPLY
* 5 NEGATIVE POWER SUPPLY
.SUBCKT TSH93 1 3 2 4 5(analog)
*****
.MODEL MDTH D IS=1E-8 KF=1.809064E-15
CJO=10F
* INPUT STAGE
CIP 2 5 1.000000E-12
CIN 1 5 1.000000E-12
EIP 10 5 2 5 1
EIN 16 5 1 5 1
RIP 10 11 2.600000E-01
RIN 15 16 2.600000E-01
RIS 11 15 3.645298E-01
DIP 11 12 MDTH 400E-12
DIN 15 14 MDTH 400E-12
VOFP 12 13 DC 0.000000E+00
VOFN 13 14 DC 0
IPOL 13 5 1.000000E-03
CPS 11 15 2.986990E-10
DINN 17 13 MDTH 400E-12
VIN 17 5 2.000000E+00
DINR 15 18 MDTH 400E-12
VIP 4 18 1.000000E+00
FCP 4 5 VOFP 3.500000E+00
FCN 5 4 VOFN 3.500000E+00
FIBP 2 5 VOFP 1.000000E-02
FIBN 5 1 VOFN 1.000000E-02
* AMPLIFYING STAGE
FIP 5 19 VOFP 2.530000E+02
FIN 5 19 VOFN 2.530000E+02
RG1 19 5 3.160721E+03
RG2 19 4 3.160721E+03
CC 19 5 2.000000E-09
DOPM 19 22 MDTH 400E-12
DONM 21 19 MDTH 400E-12
HOPM 22 28 VOUT 1.504000E+03
VIPM 28 4 5.000000E+01
HONM 21 27 VOUT 1.400000E+03
VINM 5 27 5.000000E+01
*****
RZP1 5 80 1E+06
RZP2 4 80 1E+06
GZP 5 82 19 80 2.5E-05
RZP2H 83 4 10000
RZP1H 83 82 80000
RZP2B 84 5 10000
RZP1B 82 84 80000
LZPH 4 83 3.535e-02
LZPB 84 5 3.535e-02
EOUT 26 23 82 5 1
VOUT 23 5 0
ROUT 26 3 35
COUT 3 5 30.000000E-12
DOP 19 25 MDTH 400E-12
VOP 4 25 2.361965E+00
DON 24 19 MDTH 400E-12
VON 24 5 2.361965E+00
.ENDS

```

ELECTRICAL CHARACTERISTICS

$V_{CC} = \pm 5V$, $T_{amb} = 25^{\circ}C$ (unless otherwise specified)

Symbol	Conditions	Value	Unit
V_{io}		0	mV
A_{vd}	$R_L = 600\Omega$	3.2	V/mV
I_{CC}	No load / Ampli	5.2	mA
V_{icm}		-3 to 4	V
V_{OH}	$R_L = 600\Omega$	+3.6	V
V_{OL}	$R_L = 600\Omega$	-3.6	V
I_{sink}	$V_o = 0V$	40	mA
I_{source}	$V_o = 0V$	40	mA
GBP	$R_L = 600\Omega$, $C_L = 15pF$	147	MHz
SR	$R_L = 600\Omega$, $C_L = 15pF$	110	V/ μs
ϕ_m	$R_L = 600\Omega$, $C_L = 15pF$	42	Degrees

TSH93

PACKAGE MECHANICAL DATA 14 PINS - PLASTIC MICROPACKAGE (SO)

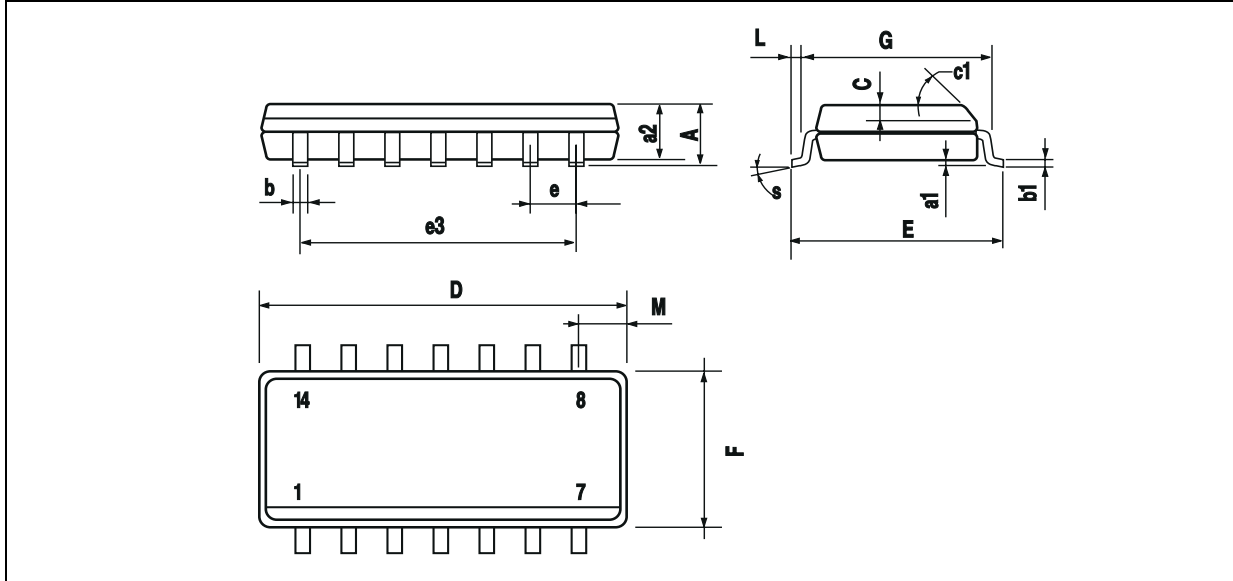

Dim.	Millimeters			Inches		
	Min.	Typ.	Max.	Min.	Typ.	Max.
A			1.75			0.069
a1	0.1		0.2	0.004		0.008
a2			1.6			0.063
b	0.35		0.46	0.014		0.018
b1	0.19		0.25	0.007		0.010
C		0.5			0.020	
c1	45° (typ.)					
D (1)	8.55		8.75	0.336		0.344
E	5.8		6.2	0.228		0.244
e		1.27			0.050	
e3		7.62			0.300	
F (1)	3.8		4.0	0.150		0.157
G	4.6		5.3	0.181		0.208
L	0.5		1.27	0.020		0.050
M			0.68			0.027
S	8° (max.)					

Note : (1) D and F do not include mold flash or protrusions - Mold flash or protrusions shall not exceed 0.15mm (.066 inc) ONLY FOR DATA BOOK.

Information furnished is believed to be accurate and reliable. However, STMicroelectronics assumes no responsibility for the consequences of use of such information nor for any infringement of patents or other rights of third parties which may result from its use. No license is granted by implication or otherwise under any patent or patent rights of STMicroelectronics. Specifications mentioned in this publication are subject to change without notice. This publication supersedes and replaces all information previously supplied. STMicroelectronics products are not authorized for use as critical components in life support devices or systems without express written approval of STMicroelectronics.

© The ST logo is a registered trademark of STMicroelectronics

© 2000 STMicroelectronics - Printed in Italy - All Rights Reserved
STMicroelectronics GROUP OF COMPANIES

Australia - Brazil - China - Finland - France - Germany - Hong Kong - India - Italy - Japan - Malaysia - Malta - Morocco
Singapore - Spain - Sweden - Switzerland - United Kingdom

© <http://www.st.com>