

- **Monolithic Silicon IC Containing Photodiode, Operational Amplifier, and Feedback Components**
- **Converts Light Intensity to Output Voltage**
- **High Irradiance Responsivity . . . Typically 60 mV/($\mu\text{W}/\text{cm}^2$) at $\lambda_p = 880 \text{ nm}$ (TSL253)**
- **High Bandwidth**
- **Compact 3-Leaded Clear Plastic Package**
- **Low Dark (Offset) Voltage . . . 10 mV Max At 25°C, $V_{DD} = 5 \text{ V}$**
- **Single-Supply Operation**
- **Wide Supply-Voltage Range . . . 2.7 V to 5.5 V**
- **Low Supply Current . . . 600 μA Typical at $V_{DD} = 5 \text{ V}$**

SR PACKAGE
 (FRONT VIEW)

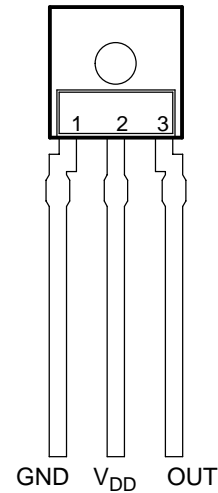

Description

The TSL253 and TSL254 are light-to-voltage optical converters, each combining a 1-mm-square photodiode and a transimpedance amplifier (feedback resistor = 16 M Ω , and 1 M Ω respectively) on a single monolithic IC. Output voltage is directly proportional to the light intensity (irradiance) on the photodiode. These devices use silicon-gate CMOS technology that provides improved amplifier offset-voltage stability and low power consumption.

Functional Block Diagram

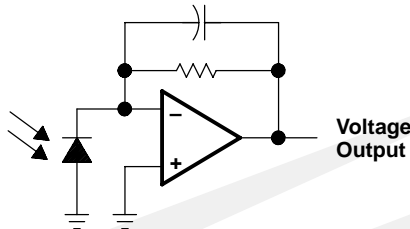

Terminal Functions

TERMINAL NAME	NO.	DESCRIPTION
GND	1	Ground (substrate). All voltages are referenced to GND.
OUT	3	Output voltage
V_{DD}	2	Supply voltage

TSL253, TSL254 PRECISION HIGH-SPEED LIGHT-TO-VOLTAGE CONVERTER

TAOS022 – JANUARY 2000

Absolute Maximum Ratings over operating free-air temperature range (unless otherwise noted)†

Supply voltage, V_{DD} (see Note 1)	7 V
Output current, I_O	± 10 mA
Duration of short-circuit current at (or below) 25°C	5 s
Operating free-air temperature range, T_A	-25°C to 85°C
Storage temperature range, T_{stg}	-25°C to 85°C
Lead temperature 1,6 mm (1/16 inch) from case for 10 seconds	240°C

† Stresses beyond those listed under “absolute maximum ratings” may cause permanent damage to the device. These are stress ratings only, and functional operation of the device at these or any other conditions beyond those indicated under “recommended operating conditions” is not implied. Exposure to absolute-maximum-rated conditions for extended periods may affect device reliability.

NOTE 1: All voltages are with respect to GND.

Recommended Operating Conditions

	MIN	MAX	UNIT
Supply voltage, V_{DD}	2.7	5.5	V
Operating free-air temperature, T_A	0	70	°C

Electrical Characteristics at $V_{DD} = 5$ V, $T_A = 25^\circ\text{C}$, $\lambda_p = 880$ nm, $R_L = 10$ k Ω (unless otherwise noted) (see Notes 2 and 3)

PARAMETER	TEST CONDITIONS	TSL253			TSL254			UNIT
		MIN	TYP	MAX	MIN	TYP	MAX	
V_D Dark voltage	$E_e = 0$			10			10	mV
V_{OM} Maximum output voltage swing	$E_e = 2$ mW/cm ²	3	3.5		3	3.5		V
V_O Output voltage	$E_e = 35$ $\mu\text{W}/\text{cm}^2$	1.6	2	2.4				V
	$E_e = 595$ $\mu\text{W}/\text{cm}^2$				1.6	2	2.4	
α_{vo} Temperature coefficient of output voltage (V_O)	300 nm < λ < 700 nm		-0.2			-0.2		%/ $^\circ\text{C}$
	$\lambda_p = 880$ nm		0.05			0.05		
N_e Irradiance responsivity			60			3.5		mV/($\mu\text{W}/\text{cm}^2$)
Power supply rejection, dc			60			60		dB
Power supply rejection, ac	$f_{ac} = 1$ kHz		18			44		dB
I_{DD} Supply current			0.6	1.5		0.6	1.5	mA

NOTES: 2. The input irradiance E_e is supplied by a GaAlAs infrared-emitting diode with $\lambda_p = 880$ nm.

3. Irradiance responsivity is characterized over the range $V_O = 0.05$ to 3 V.

Switching Characteristics at $T_A = 25^\circ\text{C}$ (see Figure 1)

PARAMETER	TEST CONDITIONS	TSL253			TSL254			UNIT
		MIN	TYP	MAX	MIN	TYP	MAX	
t_r Output pulse rise time	$V_{DD} = 5$ V, $\lambda_p = 880$ nm		7.5			2		μs
t_f Output pulse fall time	$V_{DD} = 5$ V, $\lambda_p = 880$ nm		7.5			2		μs
V_n Output noise voltage	$V_{DD} = 5$ V	$f = 100$ Hz		3		1.7		$\mu\text{V}/\sqrt{\text{Hz}}$
		$f = 1$ kHz		3		1		
		$f = 10$ kHz		6		1.3		

www.taosinc.com



PARAMETER MEASUREMENT INFORMATION

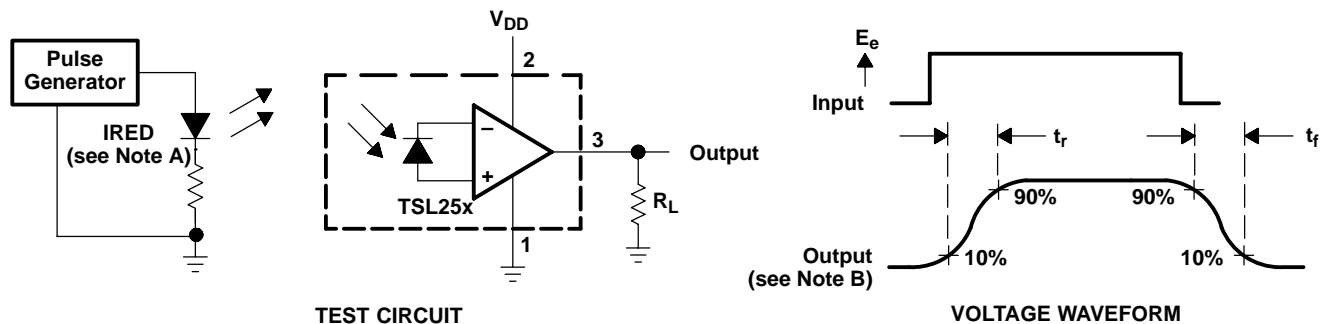

- NOTES: A. The input irradiance is supplied by a pulsed GaAlAs infrared-emitting diode with the following characteristics: $\lambda_p = 880 \text{ nm}$, $t_r < 1 \mu\text{s}$, $t_f < 1 \mu\text{s}$.
- B. The output waveform is monitored on an oscilloscope with the following characteristics: $t_r < 100 \text{ ns}$, $Z_i \geq 1 \text{ MHz}$, $C_i \leq 20 \text{ pF}$.

Figure 1. Switching Times

TSL253, TSL254 PRECISION HIGH-SPEED LIGHT-TO-VOLTAGE CONVERTER

TAOS022 – JANUARY 2000

TYPICAL CHARACTERISTICS

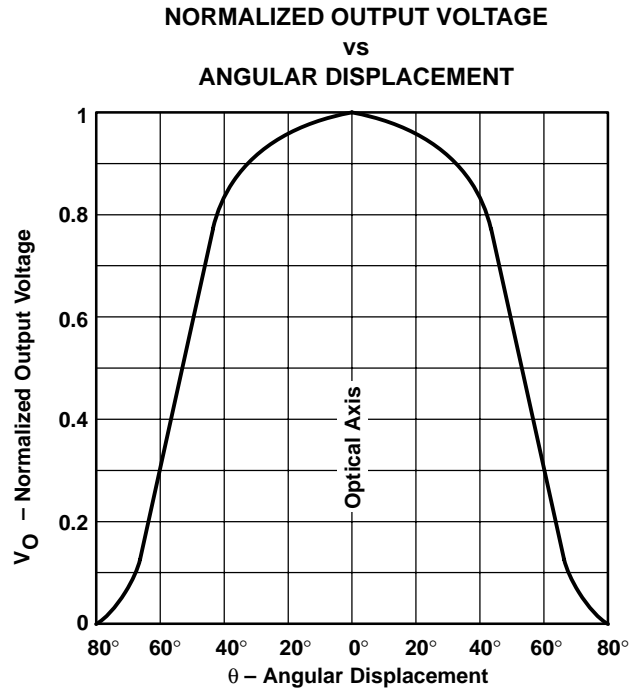
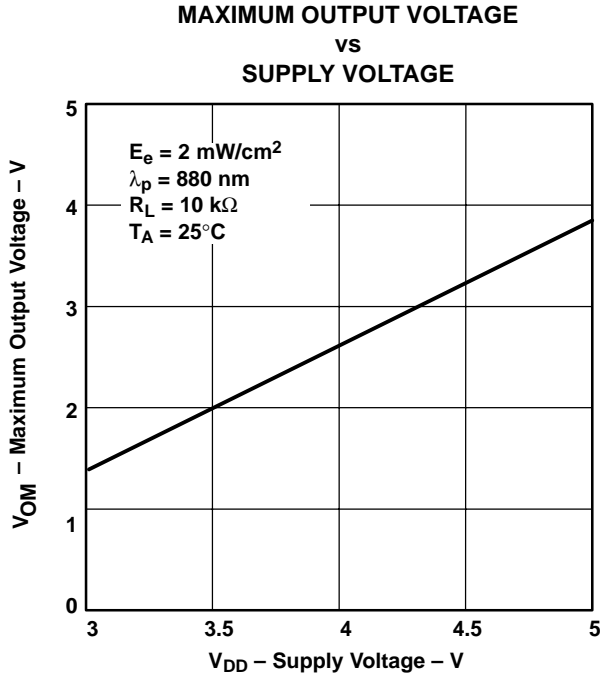
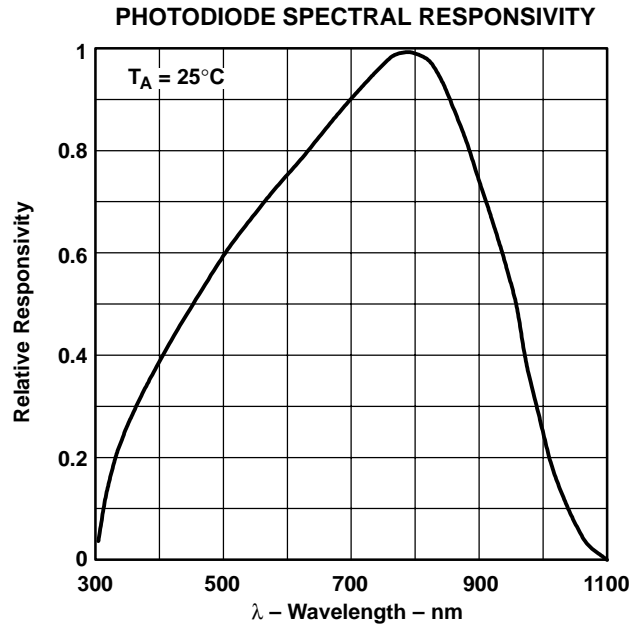
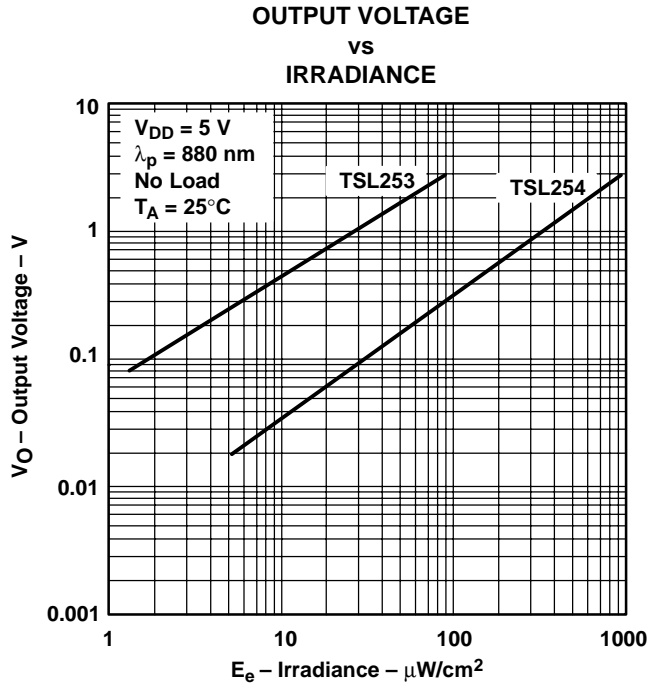

TYPICAL CHARACTERISTICS

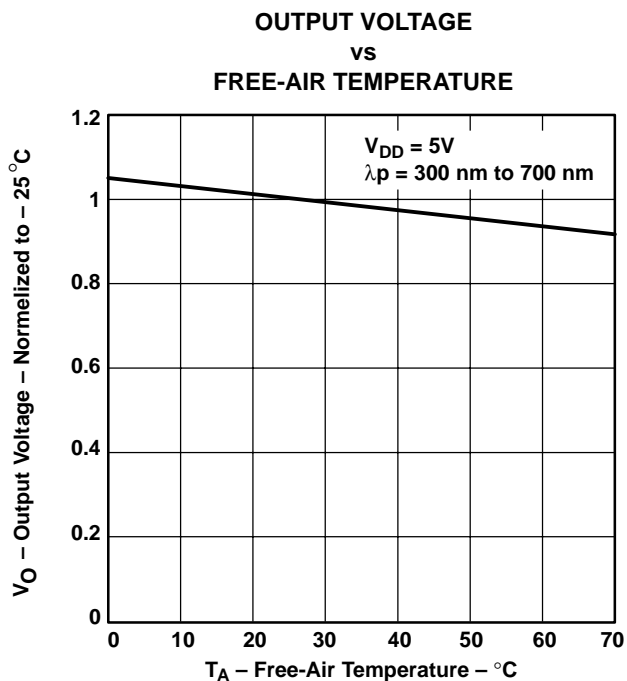
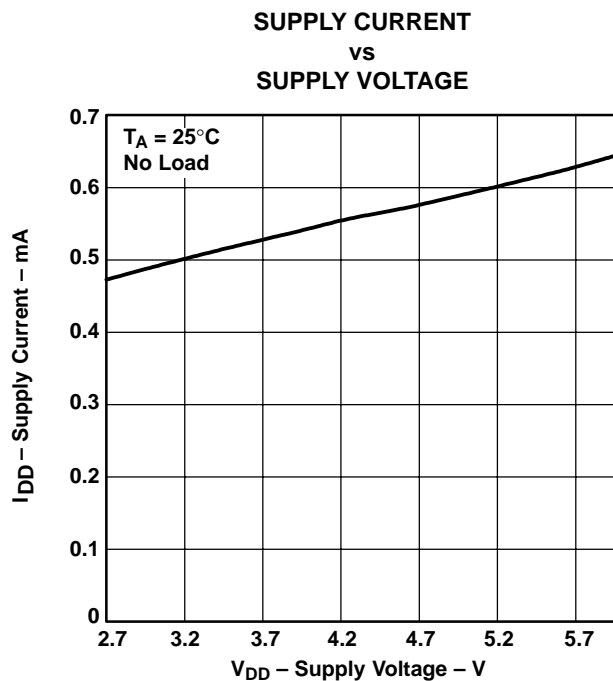
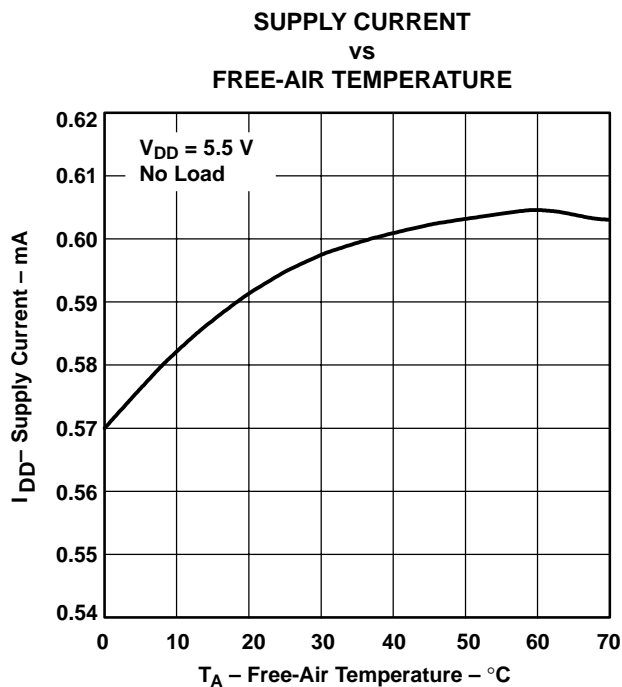
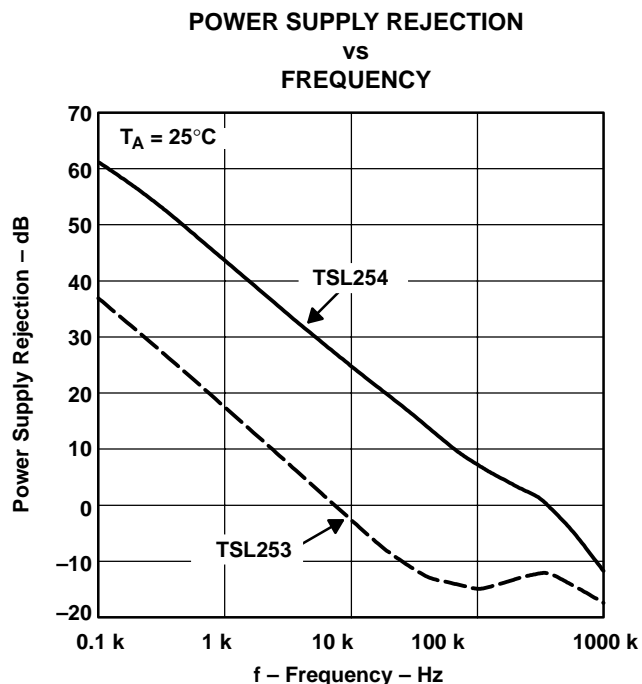

TSL253, TSL254 PRECISION HIGH-SPEED LIGHT-TO-VOLTAGE CONVERTER

TAOS022 – JANUARY 2000

TYPICAL CHARACTERISTICS

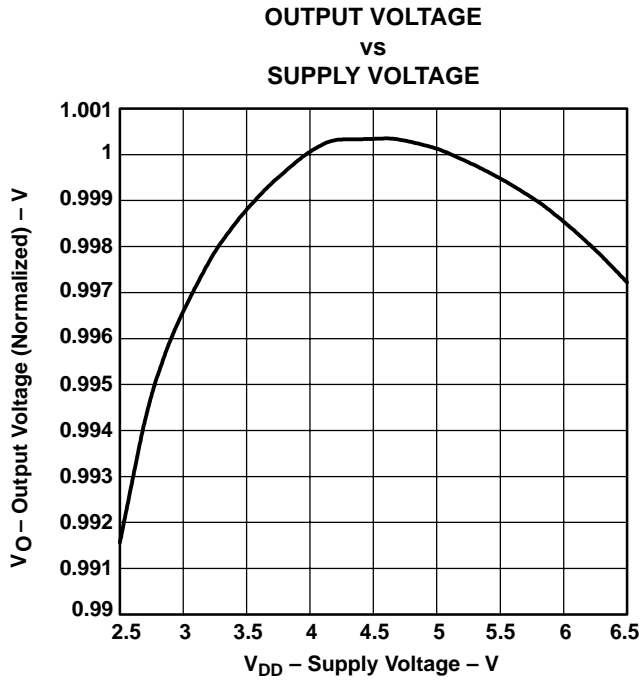

Figure 10

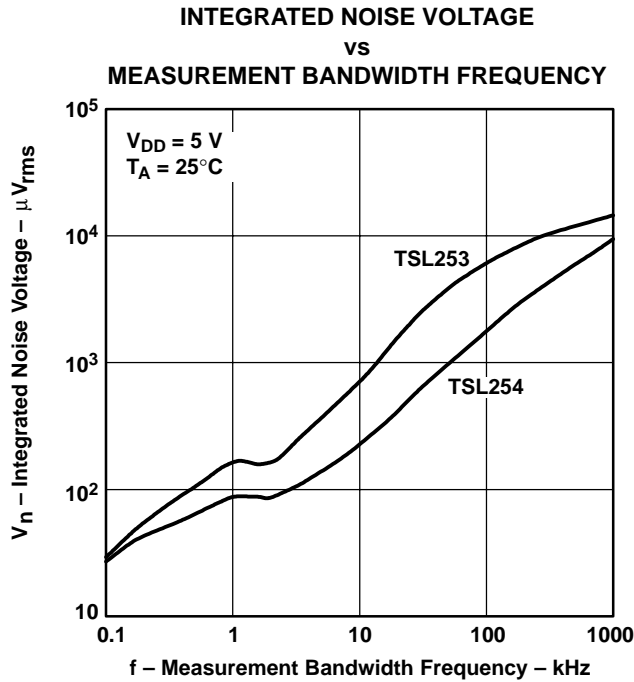
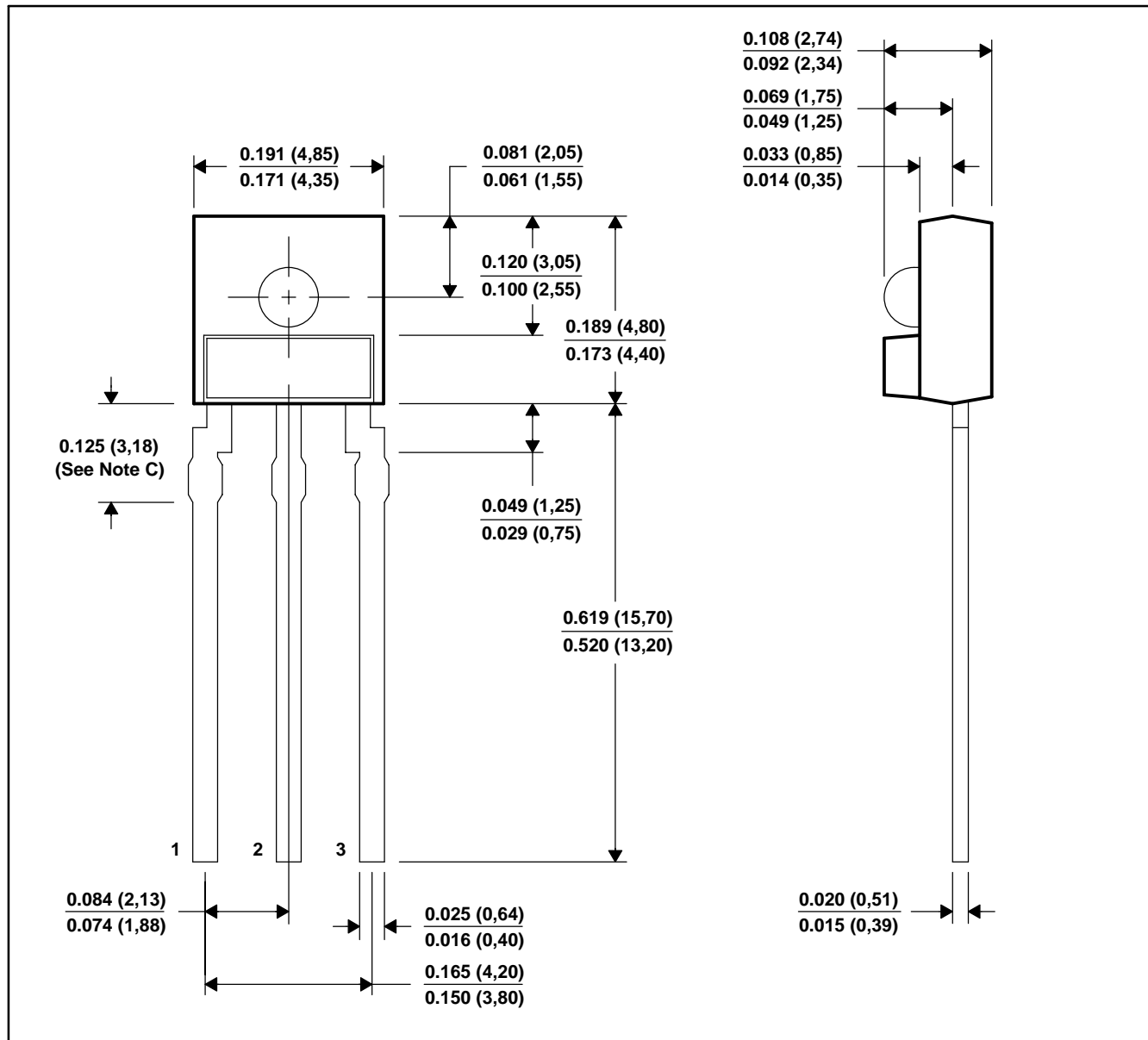

Figure 11

TSL253, TSL254 PRECISION HIGH-SPEED LIGHT-TO-VOLTAGE CONVERTER

TAOS022 – JANUARY 2000

MECHANICAL DATA PLASTIC SINGLE-IN-LINE PACKAGE (OPTO)



- NOTES:
- A. All linear dimensions are in inches (millimeters).
 - B. This drawing is subject to change without notice.
 - C. Lead dimensions are not controlled within this area.
 - D. All dimensions apply before solder dip.
 - E. Package body is a clear nonfilled optically transparent material
 - F. Index of refraction of clear plastic is 1.55.

TSL253, TSL254 PRECISION HIGH-SPEED LIGHT-TO-VOLTAGE CONVERTER

TAOS022 – JANUARY 2000

PRODUCTION DATA — information in this document is current at publication date. Products conform to specifications in accordance with the terms of Texas Advanced Optoelectronic Solutions, Inc. standard warranty. Production processing does not necessarily include testing of all parameters.

NOTICE

Texas Advanced Optoelectronic Solutions, Inc. (TAOS) reserves the right to make changes to the products contained in this document to improve performance or for any other purpose, or to discontinue them without notice. Customers are advised to contact TAOS to obtain the latest product information before placing orders or designing TAOS products into systems.

TAOS assumes no responsibility for the use of any products or circuits described in this document or customer product design, conveys no license, either expressed or implied, under any patent or other right, and makes no representation that the circuits are free of patent infringement. TAOS further makes no claim as to the suitability of its products for any particular purpose, nor does TAOS assume any liability arising out of the use of any product or circuit, and specifically disclaims any and all liability, including without limitation consequential or incidental damages.

TEXAS ADVANCED OPTOELECTRONIC SOLUTIONS, INC. PRODUCTS ARE NOT DESIGNED OR INTENDED FOR USE IN CRITICAL APPLICATIONS IN WHICH THE FAILURE OR MALFUNCTION OF THE TAOS PRODUCT MAY RESULT IN PERSONAL INJURY OR DEATH. USE OF TAOS PRODUCTS IN LIFE SUPPORT SYSTEMS IS EXPRESSLY UNAUTHORIZED AND ANY SUCH USE BY A CUSTOMER IS COMPLETELY AT THE CUSTOMER'S RISK.

Copyright © Each Manufacturing Company.

All Datasheets cannot be modified without permission.

This datasheet has been download from :

www.AllDataSheet.com

100% Free DataSheet Search Site.

Free Download.

No Register.

Fast Search System.

www.AllDataSheet.com