



# STTA306B

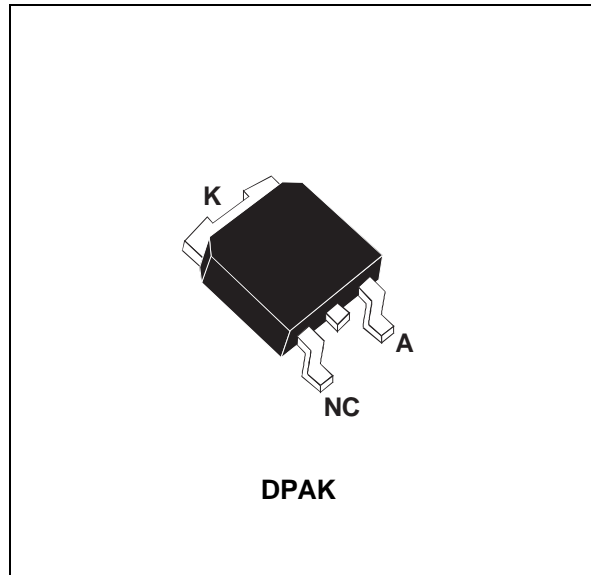
## TURBOSWITCH™ ULTRA-FAST HIGH VOLTAGE DIODE

### MAIN PRODUCT CHARACTERISTICS

<b>I<sub>F(AV)</sub></b>	<b>3 A</b>
<b>V<sub>RRM</sub></b>	<b>600 V</b>
<b>t<sub>rr</sub> (typ)</b>	<b>20 ns</b>
<b>V<sub>F</sub> (max)</b>	<b>1.65 V</b>

### FEATURES AND BENEFITS

- SPECIFIC TO FREEWHEEL MODE OPERATIONS: FREEWHEEL OR BOOSTER DIODE.
- ULTRA-FAST, AND SOFT RECOVERY.
- VERY LOW OVERALL POWER LOSSES IN BOTH THE DIODE AND THE COMPANION TRANSISTOR.
- HIGH FREQUENCY OPERATIONS.



### DESCRIPTION

The TURBOSWITCH is a very high performance series of ultra-fast high voltage power diodes. TURBOSWITCH family drastically cuts losses in both the diode and the associated switching IGBT or MOSFET in all freewheel mode operations and is particularly suitable and efficient in motor control

freewheel applications and in booster diode applications in Power Factor Control circuitries.

Packaged in DPAK, these 600V devices are particularly intended for use on 240V domestic mains.

### ABSOLUTE RATINGS (limiting values)

Symbol	Parameter		Value	Unit
V <sub>RRM</sub>	Repetitive peak reverse voltage		600	V
I <sub>F(RMS)</sub>	RMS forward current		6	A
I <sub>FRM</sub>	Repetitive peak forward current	tp=5 μs F=5 kHz square	20	A
I <sub>FSM</sub>	Surge non repetitive forward current	tp=10 ms sinusoidal	35	A
T <sub>j</sub>	Maximum operating junction temperature		125	°C
T <sub>stg</sub>	Storage temperature range		- 65 to + 150	°C

TM : TURBOSWITCH is a trademark from STMicroelectronics

## STTA306B

### THERMAL AND POWER DATA

Symbol	Parameter	Tests conditions	Value	Unit
$R_{th(j-c)}$	Junction to case		6	°C/W
$P_1$	Conduction power dissipation	$I_{F(AV)} = 1.5A, \delta = 0.5$ $T_c = 110^\circ C$	2.5	W
$P_{max}$	Total power dissipation $P_{max} = P_1 + P_3$ ( $P_3 = 10\% P_1$ )	$T_c = 108^\circ C$	2.8	W

### STATIC ELECTRICAL CHARACTERISTICS

Symbol	Parameter	Tests conditions	Min.	Typ.	Max.	Unit
$V_F^{**}$	Forward voltage drop	$T_j = 25^\circ C$	$I_F = 3 A$		1.85	V
		$T_j = 125^\circ C$	$I_F = 3 A$		1.3 1.65	
$I_R^*$	Reverse leakage current	$T_j = 25^\circ C$	$V_R = 0.8 \times V_{RRM}$		20	$\mu A$
		$T_j = 125^\circ C$			500 1200	
$V_{to}$	Threshold voltage	$I_p < 3 \cdot I_{F(AV)}$	$T_j = 125^\circ C$		1.15	V
$R_d$	Dynamic resistance				175	m $\Omega$

Test pulse : \*  $t_p = 380 \mu s, \delta < 2\%$   
 \*\*  $t_p = 5 ms, \delta < 2\%$

To evaluate the maximum conduction losses use the following equation :

$$P = V_{to} \times I_{F(AV)} + R_d \times I_{F(RMS)}^2$$

### DYNAMIC ELECTRICAL CHARACTERISTICS

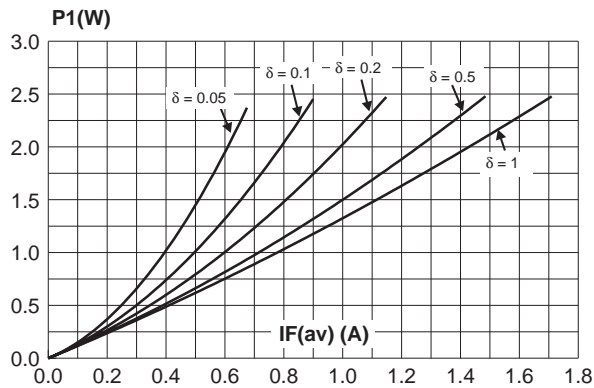
#### TURN-OFF SWITCHING

Symbol	Parameter	Test conditions	Min.	Typ.	Max.	Unit
$t_{rr}$		$T_j = 25^\circ C$ $I_F=0.5A$ $I_R=1A$ $I_{rr}=0.25A$ $I_F=1A$ $di_F/dt = -50A/\mu s$ $V_R=30V$		20	50	ns
$I_{RM}$	Maximum reverse recovery current	$T_j = 125^\circ C$ $I_F=3A$ $V_R=400V$ $di_F/dt = -16A/\mu s$ $di_F/dt = -50A/\mu s$		2.0	1.2	A
S factor	Softness factor	$T_j = 125^\circ C$ $V_R=400V$ $I_F=3A$ $di_F/dt = -50A/\mu s$		1.1		-

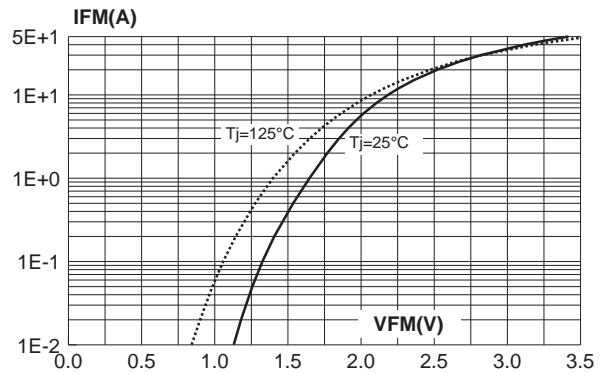
#### TURN-ON SWITCHING

Symbol	Parameter	Test conditions	Min.	Typ.	Max.	Unit
$t_{fr}$	Forward recovery time	$T_j = 25^\circ C$ $I_F=3A$ $di_F/dt = 16A/\mu s$ Measured at $1.1 \times V_{Fmax}$			500	ns
$V_{FP}$	Peak forward voltage	$T_j = 25^\circ C$ $I_F=2A$ $di_F/dt = 16A/\mu s$			10	V

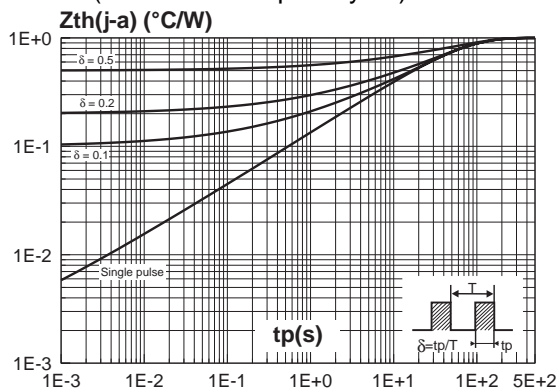
**Fig. 1:** Conduction losses versus average current.



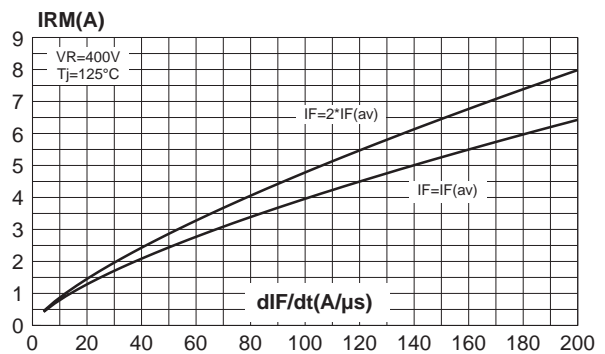
**Fig. 2:** Forward voltage drop versus forward current (maximum values).



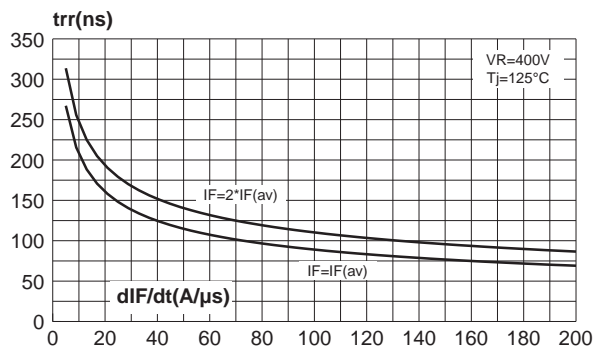
**Fig. 3:** Relative variation of thermal transient impedance junction to ambient versus pulse duration (recommended pad layout).



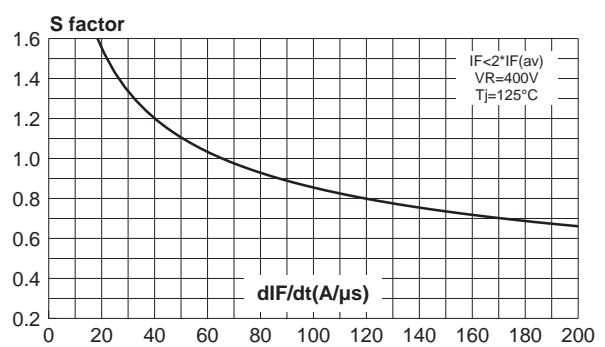
**Fig. 4:** Peak reverse recovery current versus  $dI_F/dt$  (90% confidence).



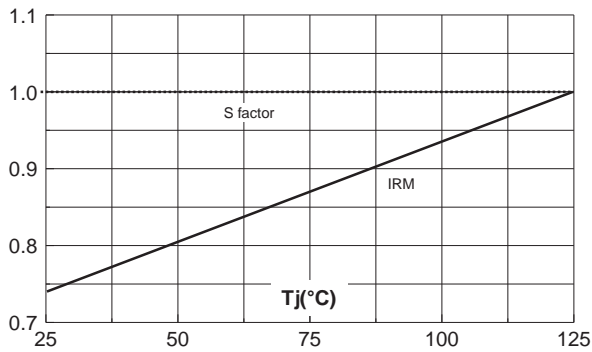
**Fig. 5:** Reverse recovery time versus  $dI_F/dt$  (90% confidence).



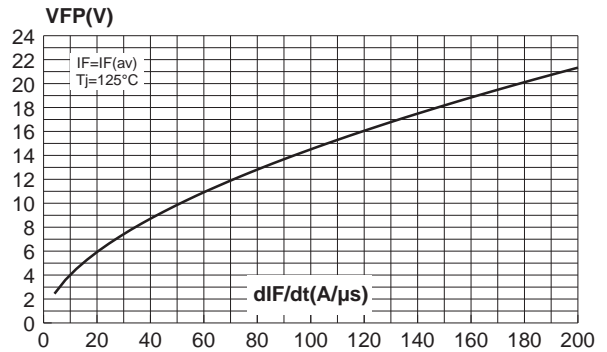
**Fig. 6:** Softness factor ( $t_b/t_a$ ) versus  $dI_F/dt$  (typical values).



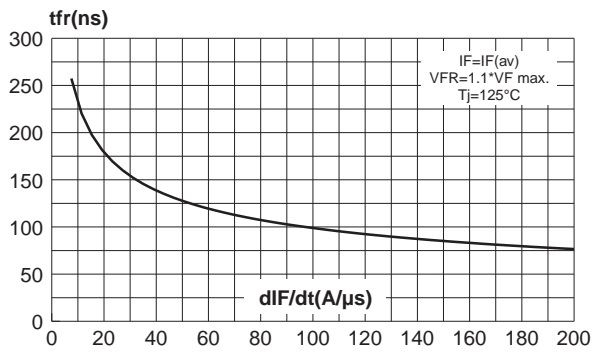
**Fig. 7:** Relative variation of dynamic parameters versus junction temperature (reference  $T_j=125^\circ\text{C}$ ).



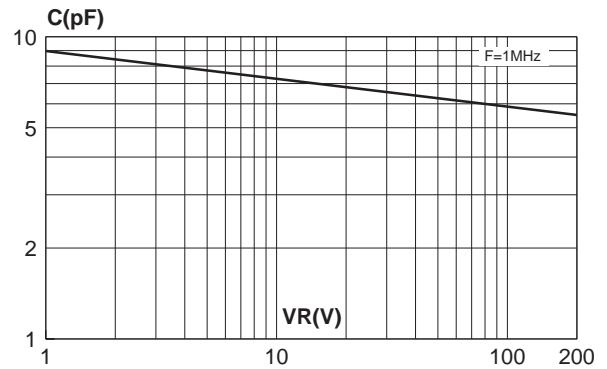
**Fig. 8:** Transient peak forward voltage versus  $dI_F/dt$  (90% confidence).



**Fig. 9:** Forward recovery time versus  $dI_F/dt$  (90% confidence).



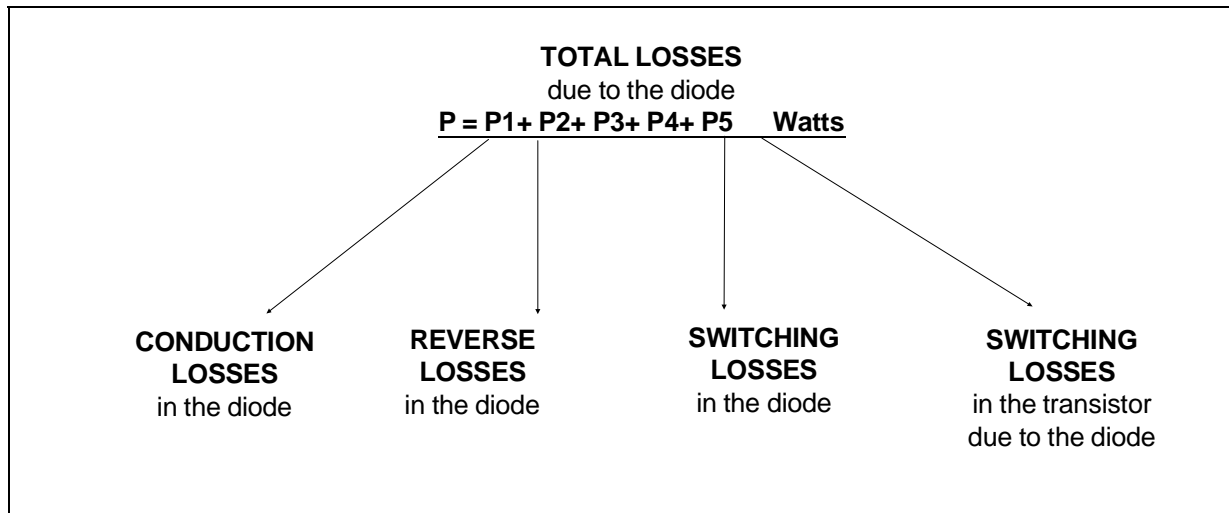
**Fig. 10:** Junction capacitance versus reverse voltage applied (typical values).



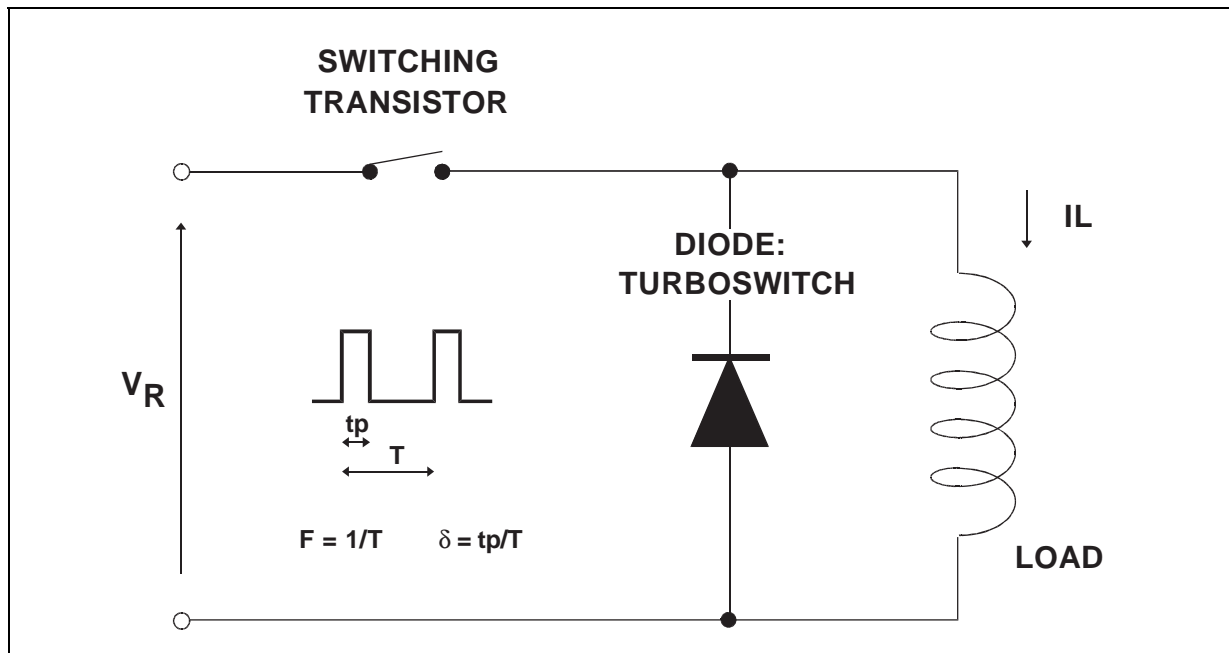
## APPLICATION DATA

The TURBOSWITCH™ is especially designed to provide the lowest overall power losses in any Freewheel Mode application (see fig. A) considering both the diode and the companion transistor, thus optimizing the overall performance in the end application.

The way of calculating the power losses is given below :

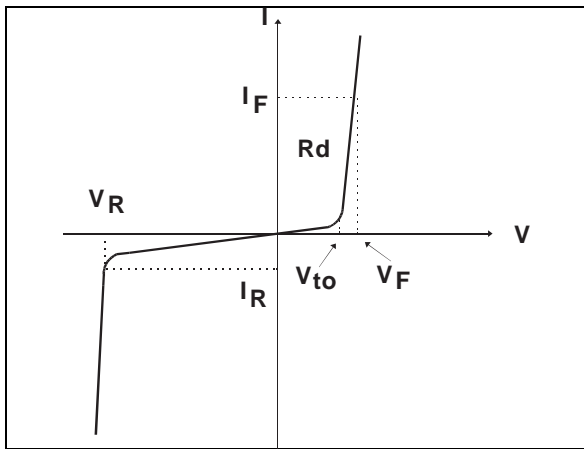


**Fig. A : "FREEWHEEL" MODE**



APPLICATION DATA (Cont'd)

Fig. B : STATIC CHARACTERISTICS



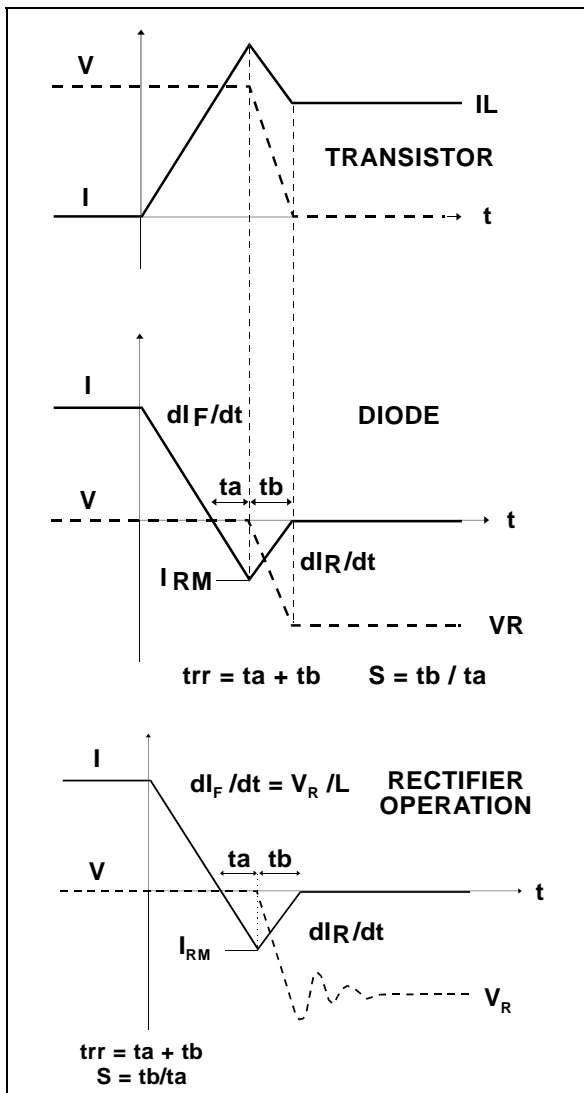
Conduction losses :

$$P1 = V_{to} \times I_{F(AV)} + R_d \times I_F^2(RMS)$$

Reverse losses :

$$P2 = V_R \times I_R \times (1 - \delta)$$

Fig. C : TURN-OFF CHARACTERISTICS



Turn-on losses :

(in the transistor, due to the diode)

$$P5 = \frac{V_R \times I_{RM}^2 \times (3 + 2 \times S) \times F}{6 \times dI_F/dt} + \frac{V_R \times I_{RM} \times I_L \times (S + 2) \times F}{2 \times dI_F/dt}$$

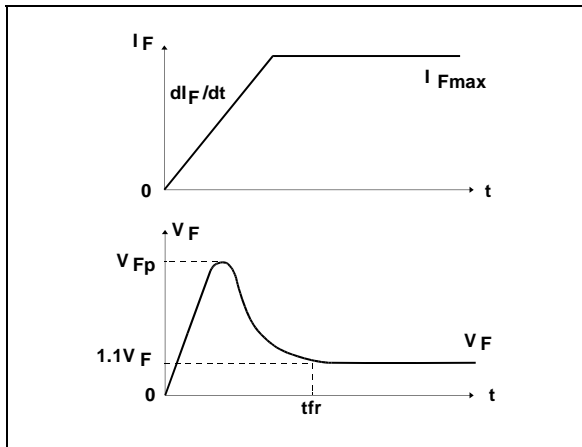
Turn-off losses (in the diode) :

$$P3 = \frac{V_R \times I_{RM}^2 \times S \times F}{6 \times dI_F/dt}$$

P3 and P5 are suitable for power MOSFET and IGBT

## APPLICATION DATA (Cont'd)

Fig. D : TURN-ON CHARACTERISTICS

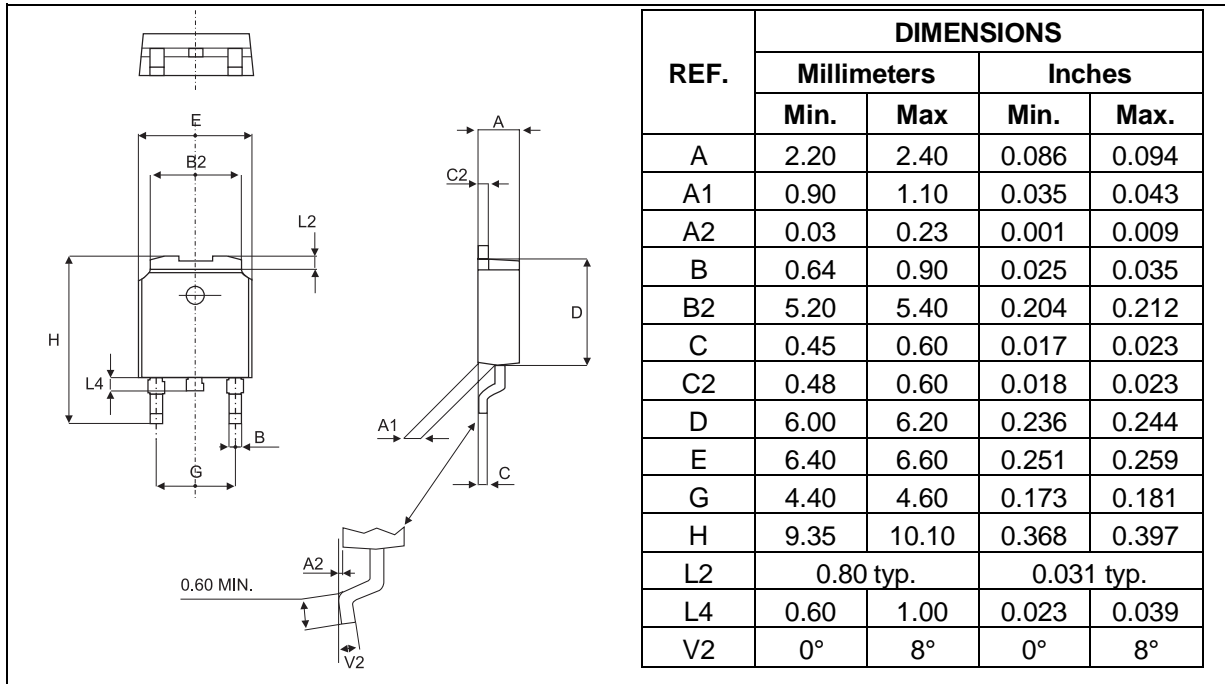


**Turn-on losses :**

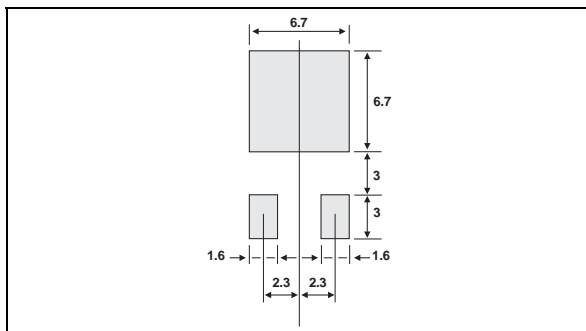
$$P_4 = 0.4 (V_{FP} - V_F) \times I_{Fmax} \times t_{fr} \times F$$

# STTA306B

## PACKAGE MECHANICAL DATA DPAK



### FOOTPRINT DIMENSIONS (in millimeters)



Ordering type	Marking	Package	Weight	Base qty	Delivery mode
STTA306B	A306	DPAK	0.3 g.	75	Tube
STTA306B-TR	A306	DPAK	0.3 g.	2500	Tape & reel

- Epoxy meets UL94,V0

Information furnished is believed to be accurate and reliable. However, STMicroelectronics assumes no responsibility for the consequences of use of such information nor for any infringement of patents or other rights of third parties which may result from its use. No license is granted by implication or otherwise under any patent or patent rights of STMicroelectronics. Specifications mentioned in this publication are subject to change without notice. This publication supersedes and replaces all information previously supplied. STMicroelectronics products are not authorized for use as critical components in life support devices or systems without express written approval of STMicroelectronics.

The ST logo is a registered trademark of STMicroelectronics

© 1999 STMicroelectronics - Printed in Italy - All rights reserved.

STMicroelectronics GROUP OF COMPANIES

Australia - Brazil - China - Finland - France - Germany - Hong Kong - India - Italy - Japan - Malaysia  
Malta - Morocco - Singapore - Spain - Sweden - Switzerland - United Kingdom - U.S.A.

<http://www.st.com>



Copyright © Each Manufacturing Company.

All Datasheets cannot be modified without permission.

This datasheet has been download from :

[www.AllDataSheet.com](http://www.AllDataSheet.com)

100% Free DataSheet Search Site.

Free Download.

No Register.

Fast Search System.

[www.AllDataSheet.com](http://www.AllDataSheet.com)