



May 1999
Revised December 1999

FSTU3384 10-Bit Bus Switch with

FSTU3384

10-Bit Bus Switch with -2V Undershoot Hardened Circuit (UHC™) Protection

General Description

The Fairchild Switch FSTU3384 provides 10 bits of high-speed CMOS TTL-compatible bus switches. The low on resistance of the switch allows inputs to be connected to outputs without adding propagation delay generating additional ground bounce noise. Both the A Ports and the B Ports are "undershoot hardened" with UHC™ protection to support an extended input range to 2.0V below ground. Fairchild's integrated Undershoot Hardened Circuit, UHC senses undershoot at the I/Os, and responds by preventing voltage differentials from developing and turning on the switch. The device is organized as two 5-bit switches with separate bus enable (OE) signals. When \overline{OE} is LOW, the switch is ON and Port A is connected to Port B. When \overline{OE} is HIGH, the switch is OPEN and a high-impedance state exists between the two ports.

Features

- 4Ω switch connection between two ports
- Undershoot Hardened to -2.0V.
- Minimal propagation delay through the switch
- Low I_{CC} .
- Zero ground bounce in flow-through mode
- Control inputs compatible with TTL level
- See Applications Note AN-5008 for details.

Ordering Code:

Order Number	Package Number	Package Description
FSTU3384WM	M24B	24-Lead Small Outline Integrated Circuit (SOIC), JEDEC MO-153 4.4mm Wide
FSTU3384QSC	MQA24	24-Lead Quarter Size Outline Package (QSOP), JEDEC MO-137, 0.150" Wide
FSTU3384MTC	MTC24	24-Lead Thin Shrink Small Outline Package (TSSOP), JEDEC MO-153, 4.4mm Wide

Devices also available in Tape and Reel. Specify by appending the suffix letter "X" to the ordering code.

Logic Diagram

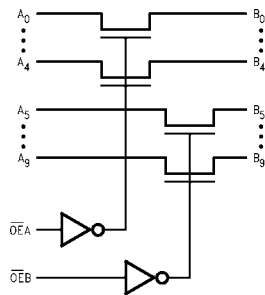

Connection Diagram

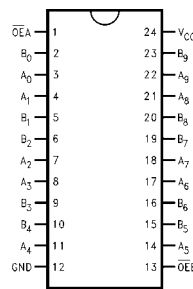

Pin Descriptions

Pin Names	Description
\overline{OE}_A , \overline{OE}_B	Bus Switch Enable
A_0 - A_9	Bus A
B_0 - B_9	Bus B

Truth Table

\overline{OE}_A	\overline{OE}_B	B_0 - B_4	B_5 - B_9	Function
L	L	A_0 - A_4	A_5 - A_9	Connect
L	H	A_0 - A_4	HIGH-Z State	Connect
H	L	HIGH-Z State	A_5 - A_9	Connect
H	H	HIGH-Z State	HIGH-Z State	Disconnect

UHC™ is a trademark of Fairchild Semiconductor Corporation.

Absolute Maximum Ratings(Note 1)

Supply Voltage (V_{CC})	-0.5V to +7.0V
DC Switch Voltage (V_S)	-2.0V to +7.0V
DC Input Voltage (V_{IN}) (Note 2)	-0.5V to +7.0V
DC Input Diode Current (I_{IK}) $V_{IN} < 0V$	-50 mA
DC Output (I_{OUT}) Sink Current	128 mA
DC V_{CC}/GND Current (I_{CC}/I_{GND})	+/- 100mA
Storage Temperature Range (T_{STG})	-65°C to +150°C

Recommended Operating Conditions (Note 3)

Power Supply Operating (V_{CC})	4.0V to 5.5V
Input Voltage (V_{IN})	0V to 5.5V
Output Voltage (V_{OUT})	0V to 5.5V
Input Rise and Fall Time (t_r, t_f)	
Switch Control Input	0nS/V to 5nS/V
Switch I/O	0nS/V to DC
Free Air Operating Temperature (T_A)	-40°C to +85°C

Note 1: The "Absolute Maximum Ratings" are those values beyond which the safety of the device cannot be guaranteed. The device should not be operated at these limits. The parametric values defined in the "Electrical Characteristics" table are not guaranteed at the absolute maximum ratings. The "Recommended Operating Conditions" table will define the conditions for actual device operation.

Note 2: The input and output negative voltage ratings may be exceeded if the input and output diode current ratings are observed.

Note 3: Unused control inputs must be held HIGH or LOW. They may not float.

DC Electrical Characteristics

Symbol	Parameter	V_{CC} (V)	$T_A = -40^\circ\text{C to } +85^\circ\text{C}$			Units	Condition
			Min	Typ (Note 5)	Max		
V_{IK}	Clamp Diode Voltage	4.5			-1.2	V	$I_{IN} = -18\text{ mA}$
V_{IH}	HIGH Level Input Voltage	4.0-5.5	2.0			V	
V_{IL}	LOW Level Input Voltage	4.0-5.5			0.8	V	
I_I	Input Leakage Current	5.5			± 1.0	μA	$0 \leq V_{IN} \leq 5.5V$
I_{OZ}	OFF-STATE Leakage Current	5.5			± 1.0	μA	$0 \leq A, B \leq V_{CC}, V_{IN} = V_{IH}$
R_{ON}	Switch On Resistance (Note 4)	4.5		4	7	Ω	$V_S = 0V, I_{IN} = 64\text{ mA}$
		4.5		4	7	Ω	$V_S = 0V, I_{IN} = 30\text{ mA}$
		4.5		8	15	Ω	$V_S = 2.4V, I_{IN} = 15\text{ mA}$
		4.0		11	20	Ω	$V_S = 2.4V, I_{IN} = 15\text{ mA}$
I_{CC}	Quiescent Supply Current	5.5			3	μA	$V_S = V_{CC}$ or GND, $I_{OUT} = 0$
ΔI_{CC}	Increase in I_{CC} per Input	5.5			2.5	mA	\overline{OE} input at 3.4V Other inputs at V_{CC} or GND
I_{BIAS}	Bias Pin Leakage Current	5.5			± 1.0	μA	$\overline{OE} = 0V, B = 0V, BiasV = 5.5V$
I_{OZU}	Switch Undershoot Current	5.5			100	μA	$I_{IN} = -20\text{ mA}, \overline{OE} = 5.5V, V_{OUT} \geq V_{IH}$
V_{IKU}	Voltage Undershoot	5.5			-2.0	V	$0.0\text{ mA} \geq I_{IN} \geq -50\text{ mA}, \overline{OE} = 5.5V$

Note 4: Measured by voltage drop between A and B pin at indicated current through the switch. On resistance is determined by the lower of the voltages on the two (A or B) pins.

Note 5: All typical values are at $V_{CC} = 5.0V, T_A = 25^\circ\text{C}$.

AC Electrical Characteristics

Symbol	Parameter	$T_A = -40^{\circ}\text{C to } +85^{\circ}\text{C}$ $C_L = 50\text{ pF, } R_U = R_D = 500\Omega$				Units	Conditions	Figure No.
		$V_{CC} = 4.5 - 5.5\text{V}$		$V_{CC} = 4.0\text{V}$				
		Min	Max	Min	Max			
t_{PHL}, t_{PLH}	Prop Delay Bus to Bus (Note 6)		0.25		0.25	ns	$V_I = \text{OPEN}$	Figure 1, Figure 2
t_{PZH}, t_{PZL}	Output Enable Time $\overline{OE}_A, \overline{OE}_B$ to A_n, B_n	1.0	5.7		6.2	ns	$V_I = 7\text{V}$ for t_{PZL} $V_I = \text{OPEN}$ for t_{PZH}	Figure 1, Figure 2
t_{PHZ}, t_{PLZ}	Output Disable Time $\overline{OE}_A, \overline{OE}_B$ to A_n, B_n	1.5	5.2		5.5	ns	$V_I = 7\text{V}$ for t_{PLZ} $V_I = \text{OPEN}$ for t_{PHZ}	Figure 1, Figure 2

Note 6: This parameter is guaranteed by design but not tested. The bus switch contributes no propagation delay other than the RC delay of the typical On resistance of the switch and the 50pF load capacitance, when driven by an ideal voltage source (zero output impedance).

Capacitance (Note 7)

Symbol	Parameter	Typ	Max	Units	Conditions
C_{IN}	Control Input Capacitance	3		pF	$V_{CC} = 5.0\text{V}$
$C_{I/O} (\text{OFF})$	Input/Output Capacitance	5		pF	$V_{CC}, \overline{OE} = 5.0\text{V}$

Note 7: Capacitance is characterized but not tested.

AC Loading and Waveforms

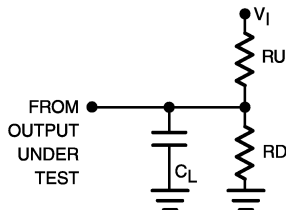

Note: Input driven by 50 Ω source terminated in 50 Ω , $R_U = R_D = 500\ \Omega$

Note: C_L includes load and stray capacitance, $C_L = 50\ \text{pF}$

Note: Input PRR = 1.0 MHz, $t_W = 500\ \text{nS}$

FIGURE 1. AC Test Circuit

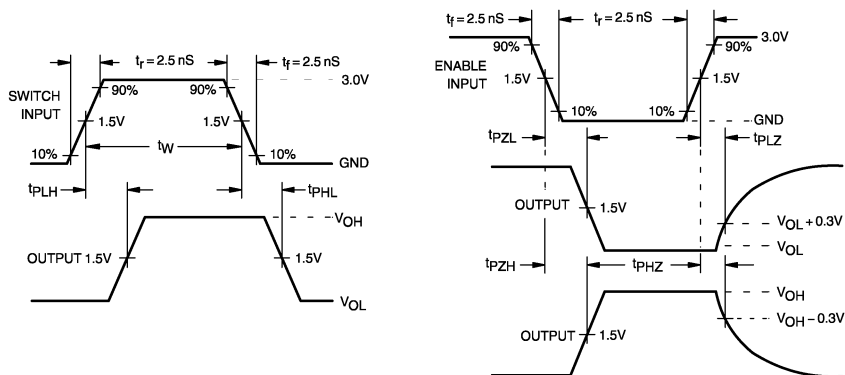
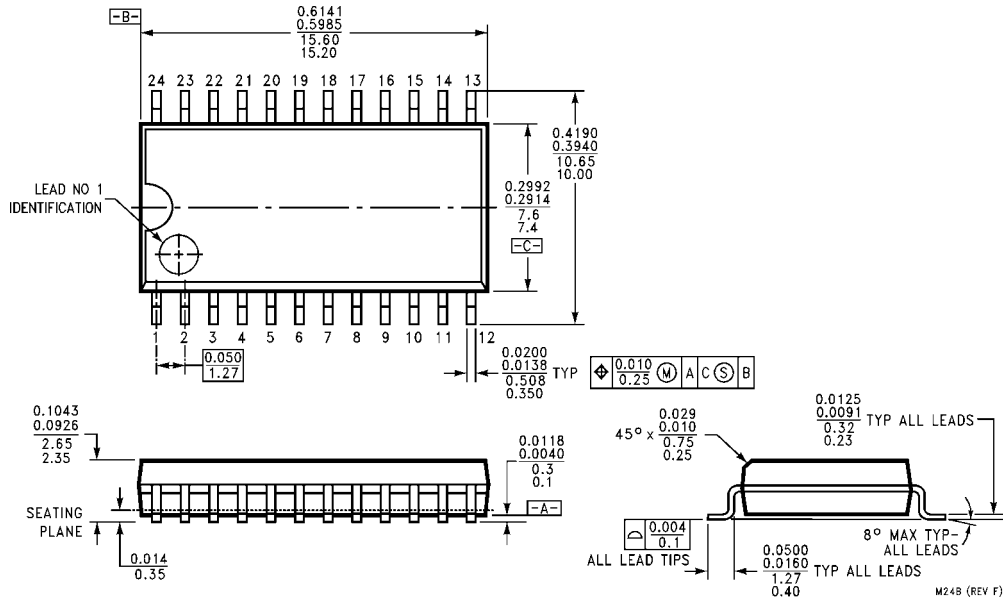
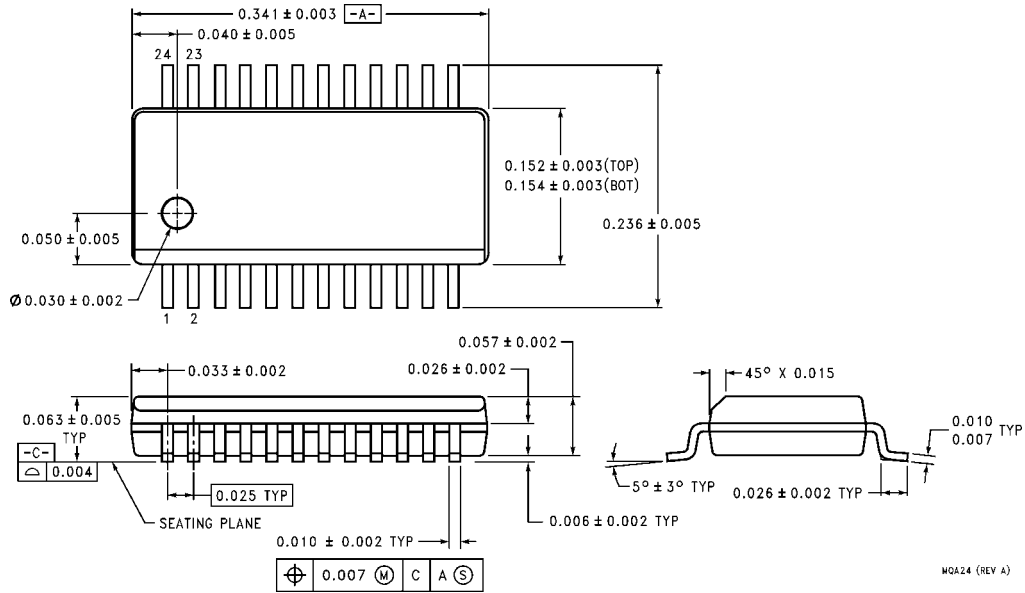

FIGURE 2. AC Waveforms

Physical Dimensions inches (millimeters) unless otherwise noted



24-Lead Small Outline Integrated Circuit (SOIC), JEDEC MO-153 4.4mm Wide Package Number M24B



24-Lead Quarter Size Outline Package (QSOP), JEDEC MO-137, 0.150" Wide Package Number MQA24

Physical Dimensions inches (millimeters) unless otherwise noted (Continued)

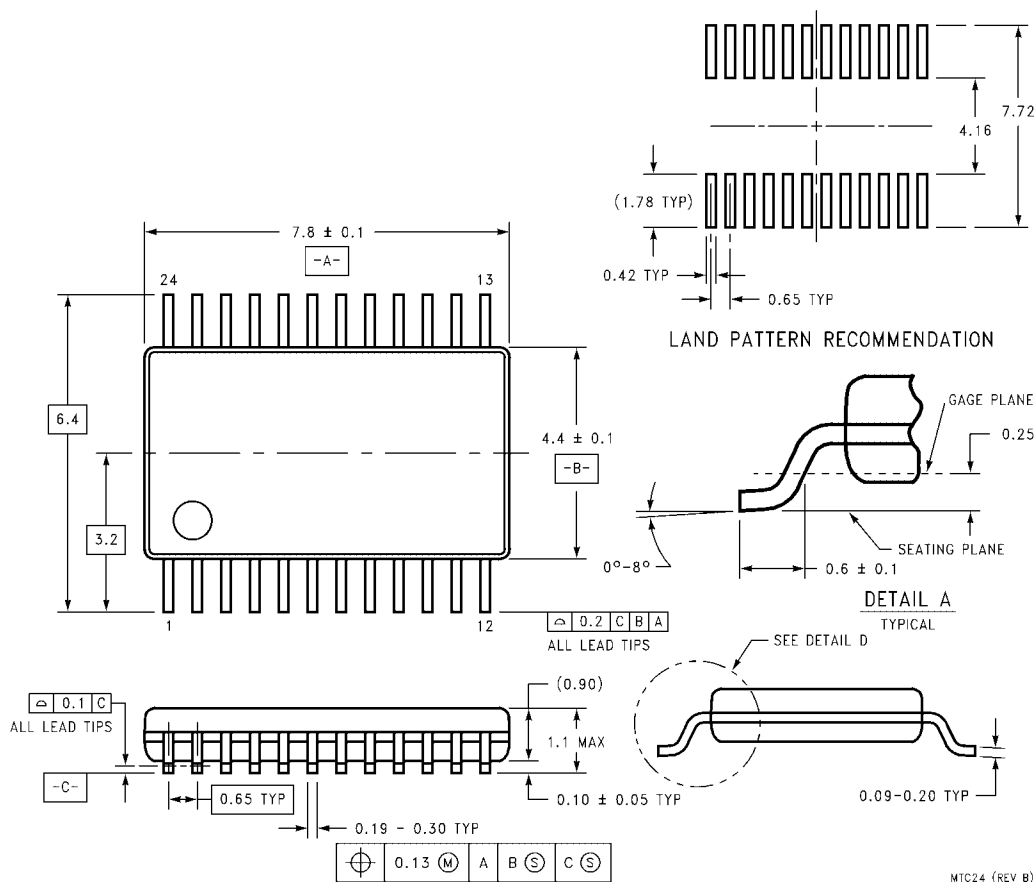

**24-Lead Thin Shrink Small Outline Package (TSSOP), JEDEC MO-153, 4.4mm Wide
Package Number MTC24**

Technology Description

The Fairchild Switch family derives from and embodies Fairchild's proven switch technology used for several years in its 74LVX3L384 (FST3384) bus switch product.

Fairchild does not assume any responsibility for use of any circuitry described, no circuit patent licenses are implied and Fairchild reserves the right at any time without notice to change said circuitry and specifications.

LIFE SUPPORT POLICY

FAIRCHILD'S PRODUCTS ARE NOT AUTHORIZED FOR USE AS CRITICAL COMPONENTS IN LIFE SUPPORT DEVICES OR SYSTEMS WITHOUT THE EXPRESS WRITTEN APPROVAL OF THE PRESIDENT OF FAIRCHILD SEMICONDUCTOR CORPORATION. As used herein:

1. Life support devices or systems are devices or systems which, (a) are intended for surgical implant into the body, or (b) support or sustain life, and (c) whose failure to perform when properly used in accordance with instructions for use provided in the labeling, can be reasonably expected to result in a significant injury to the user.
2. A critical component in any component of a life support device or system whose failure to perform can be reasonably expected to cause the failure of the life support device or system, or to affect its safety or effectiveness.

www.fairchildsemi.com

Copyright © Each Manufacturing Company.

All Datasheets cannot be modified without permission.

This datasheet has been download from :

www.AllDataSheet.com

100% Free DataSheet Search Site.

Free Download.

No Register.

Fast Search System.

www.AllDataSheet.com