

## N-Channel JFETs

<b>PRODUCT SUMMARY</b>				
Part Number	$V_{GS(off)}$ (V)	$r_{DS(on)}$ Max ( $\Omega$ )	$I_{D(off)}$ Typ ( $\mu$ A)	$t_{ON}$ Typ (ns)
U290	-4.0 to -10	3	10	14
U291	-1.5 to -4.5	7	10	14

### FEATURES

- Low On-Resistance: U290 < 3  $\Omega$
- Fast Switching— $t_{ON}$ : 14 ns
- High Off-Isolation
- Low Capacitance: 20 pF
- Low Insertion Loss

### BENEFITS

- Low Error Voltage
- High-Speed Analog Circuit Performance
- Negligible "Off-Error," Excellent Accuracy
- Good Frequency Response
- Eliminates Additional Buffering

### APPLICATIONS

- Analog Switches
- Choppers
- Sample-and-Hold
- Normally "On" Switches
- Current Limiters

### DESCRIPTION

The U290/U291 are high-performance JFET analog switches designed to offer low on-resistance and fast switching. This series features the lowest on-resistance of any JFET in the industry today.

For similar products in TO-226A (TO-92) packaging, see the J105/106/107 data sheet.

The TO-206AC (TO-52) hermetically sealed case makes this series suitable for military applications.

Ordering Information: U290—E3  
U291—E3

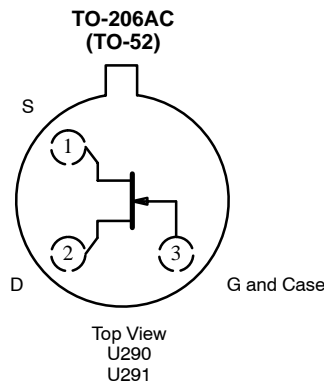

### ABSOLUTE MAXIMUM RATINGS

Gate-Drain, Gate-Source Voltage . . . . . -30 V  
 Gate Current . . . . . 100 mA  
 Storage Temperature . . . . . -65 to 200°C  
 Operating Junction Temperature . . . . . -55 to 150°C

Power Dissipation<sup>a</sup> . . . . . 500 mW

Notes  
 a. Derate 4 mW/°C above 25°C



SPECIFICATIONS (T <sub>A</sub> = 25 °C UNLESS OTHERWISE NOTED)								
Parameter	Symbol	Test Conditions	Typ <sup>a</sup>	Limits				Unit
				U290		U291		
				Min	Max	Min	Max	
<b>Static</b>								
Gate-Source Breakdown Voltage	V <sub>(BR)GSS</sub>	I <sub>G</sub> = -1 μA, V <sub>DS</sub> = 0 V	-35	-30		-30		V
Gate-Source Cutoff Voltage	V <sub>GS(off)</sub>	V <sub>DS</sub> = 15 V, I <sub>D</sub> = 3 nA		-4.0	-10	-1.5	-4.5	
Saturation Drain Current <sup>b</sup>	I <sub>DSS</sub>	V <sub>DS</sub> = 10 V, V <sub>GS</sub> = 0 V		500		200		mA
Gate Reverse Current	I <sub>GSS</sub>	V <sub>GS</sub> = -15 V, V <sub>DS</sub> = 0 V	-0.02		-1		-1	nA
		T <sub>A</sub> = 125 °C	-0.01		-1		-1	μA
Gate Operating Current <sup>b</sup>	I <sub>G</sub>	V <sub>DG</sub> = 10 V, I <sub>D</sub> = 25 mA	-0.01					nA
Drain Cutoff Current	I <sub>D(off)</sub>	V <sub>DS</sub> = 5 V, V <sub>GS</sub> = -10 V	0.01		1		1	μA
		T <sub>A</sub> = 125 °C	-0.005		1		1	μA
Drain-Source On-Resistance	r <sub>DS(on)</sub>	V <sub>GS</sub> = 0 V, I <sub>D</sub> = 1 mA			3		7	Ω
Gate-Source Forward Voltage	V <sub>GS(F)</sub>	I <sub>G</sub> = 1 mA, V <sub>DS</sub> = 0 V	0.7					V
<b>Dynamic</b>								
Common-Source Forward Transconductance <sup>b</sup>	g <sub>fs</sub>	V <sub>DS</sub> = 10 V, I <sub>D</sub> = 25 mA, f = 1 kHz	55					mS
Common-Source Output Conductance <sup>b</sup>	g <sub>os</sub>		5					
Drain-Source On-Resistance	r <sub>ds(on)</sub>	V <sub>GS</sub> = 0 V, I <sub>D</sub> = 1 mA, f = 1 kHz			3		7	Ω
Common-Source Input Capacitance	C <sub>iss</sub>	V <sub>DS</sub> = 0 V, V <sub>GS</sub> = 0 V, f = 1 MHz	120		160		160	pF
Common-Source Reverse Transfer Capacitance	C <sub>rss</sub>	V <sub>DS</sub> = 0 V, V <sub>GS</sub> = -15 V, f = 1 MHz	20		30		30	
Equivalent Input Noise Voltage	e <sub>n</sub>	V <sub>DG</sub> = 10 V, I <sub>D</sub> = 25 mA, f = 1 kHz	3					nV/√Hz
<b>Switching</b>								
Turn-On Time	t <sub>d(on)</sub>	V <sub>DD</sub> = 1.5 V, V <sub>GS(H)</sub> = 0 V See Switching Diagram	6		15		15	ns
	t <sub>r</sub>		8		20		20	
Turn-Off Time	t <sub>d(off)</sub>		5		15		15	
	t <sub>f</sub>		9		20		20	

**Notes**

- a. Typical values are for DESIGN AID ONLY, not guaranteed nor subject to production testing.
- b. Pulse test: PW ≤ 300 μs duty cycle ≤ 3%.

NVA

### TYPICAL CHARACTERISTICS (T<sub>A</sub> = 25 °C UNLESS OTHERWISE NOTED)

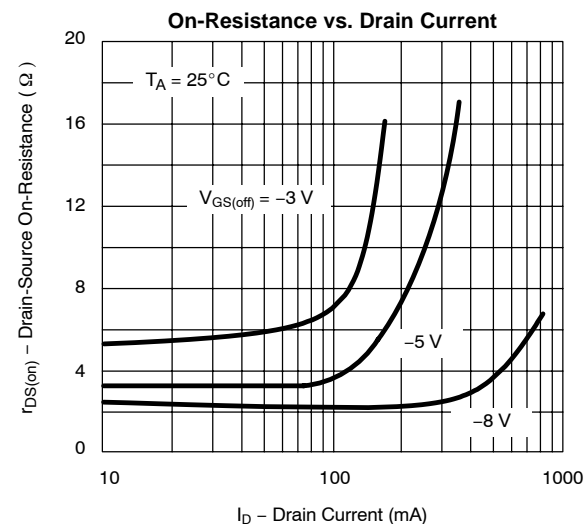
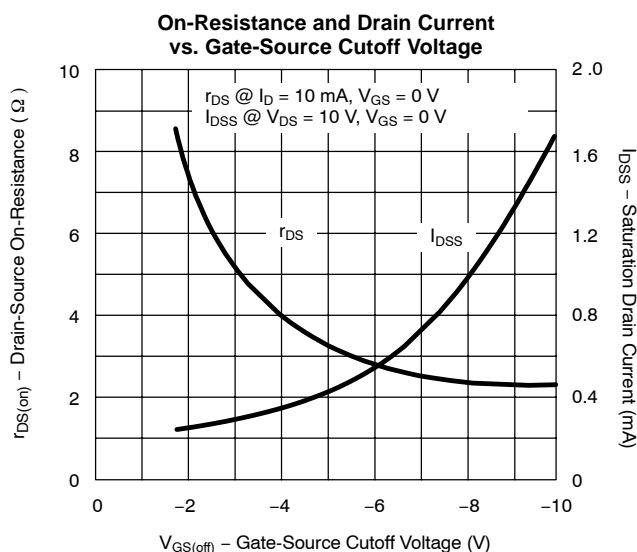



**TYPICAL CHARACTERISTICS ( $T_A = 25^\circ\text{C}$  UNLESS OTHERWISE NOTED)**

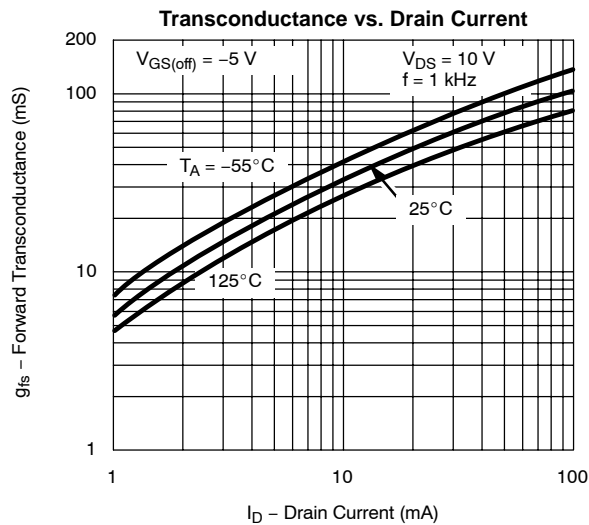
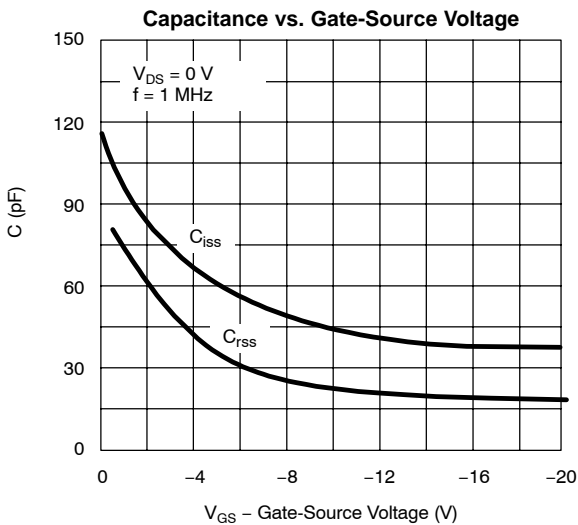
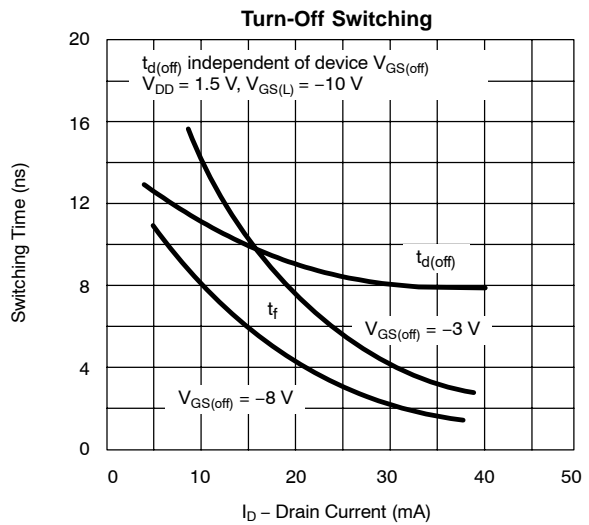
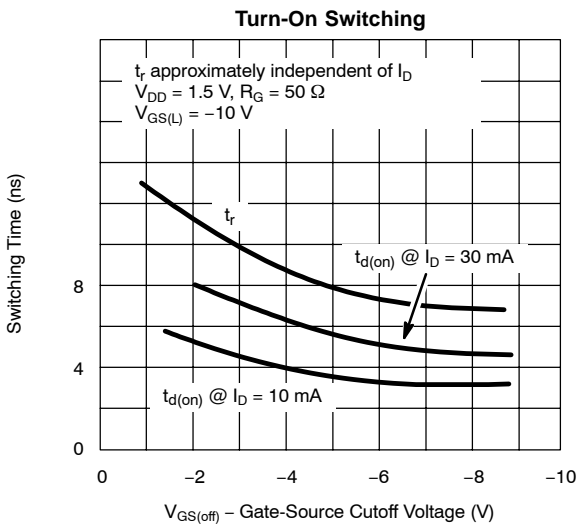
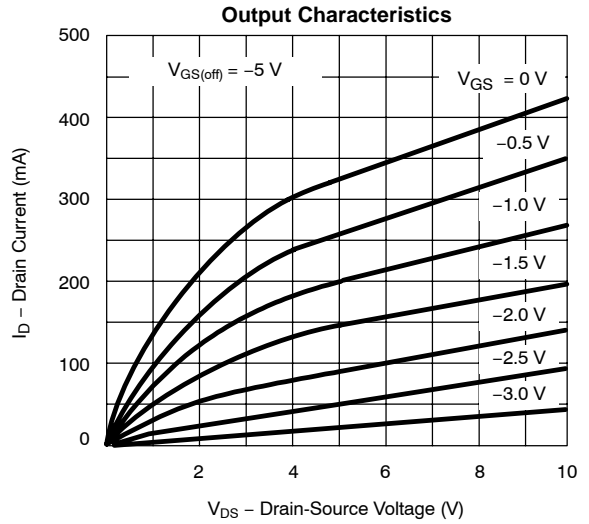
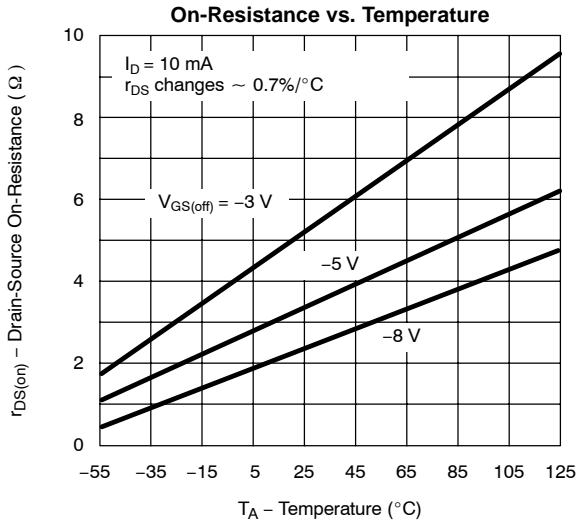

**TYPICAL CHARACTERISTICS (T<sub>A</sub> = 25°C UNLESS OTHERWISE NOTED)**

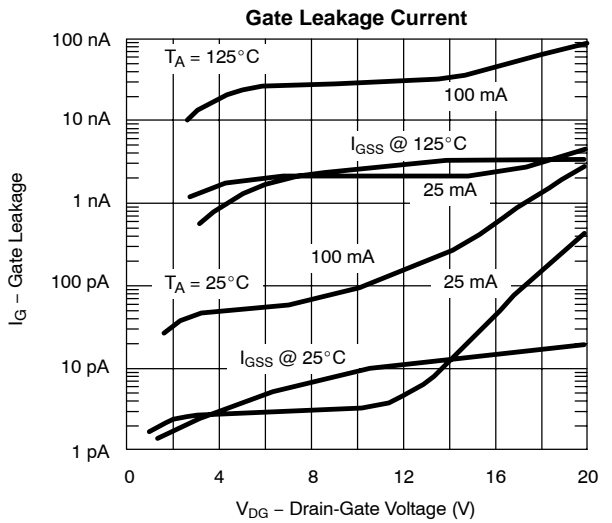
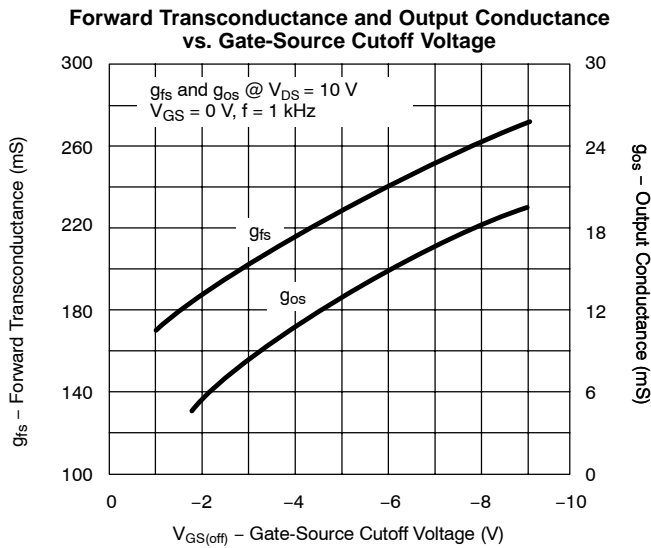
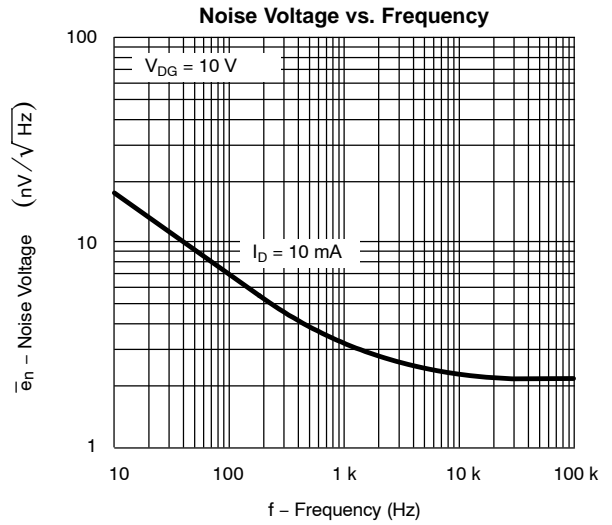
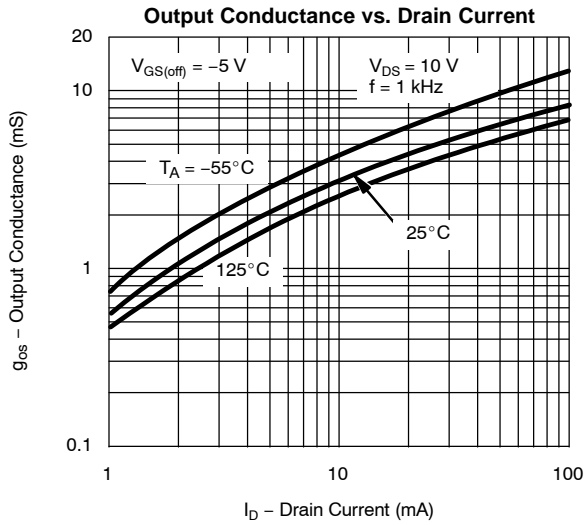

SWITCHING TIME TEST CIRCUIT		
	U290	U291
V <sub>GS(L)</sub>	-12 V	-7 V
R <sub>L</sub> *	50 Ω	50 Ω
I <sub>D(on)</sub>	28 mA	27 mA

\* Non-Inductive

**Input Pulse**

Rise Time < 1 ns  
 Fall Time < 1 ns  
 Pulse Width 100 ns  
 PRF 1 MHz

**Sampling Scope**

Rise Time 0.4 ns  
 Input Resistance 10 MΩ  
 Input Capacitance 1.5 pF

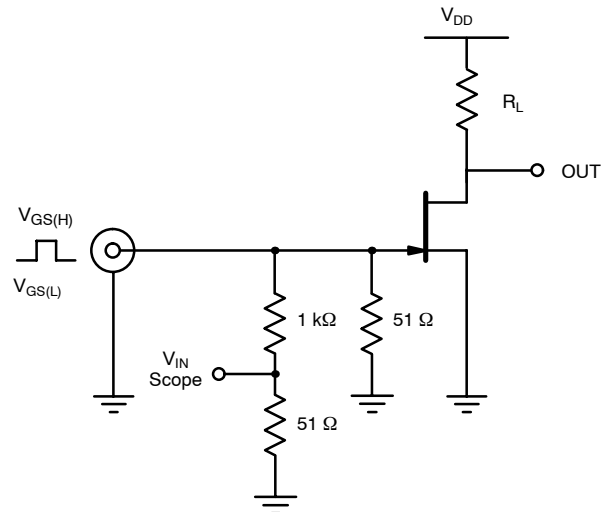



## Notice

Specifications of the products displayed herein are subject to change without notice. Vishay Intertechnology, Inc., or anyone on its behalf, assumes no responsibility or liability for any errors or inaccuracies.

Information contained herein is intended to provide a product description only. No license, express or implied, by estoppel or otherwise, to any intellectual property rights is granted by this document. Except as provided in Vishay's terms and conditions of sale for such products, Vishay assumes no liability whatsoever, and disclaims any express or implied warranty, relating to sale and/or use of Vishay products including liability or warranties relating to fitness for a particular purpose, merchantability, or infringement of any patent, copyright, or other intellectual property right.

The products shown herein are not designed for use in medical, life-saving, or life-sustaining applications. Customers using or selling these products for use in such applications do so at their own risk and agree to fully indemnify Vishay for any damages resulting from such improper use or sale.