

RF MOSFET Power Transistor, 40W, 28V

100 - 500 MHz

UF2840P

V2.00

Features

- N-Channel Enhancement Mode Device
- DMOS Structure
- Lower Capacitances for Broadband Operation
- Common Source Configuration
- Lower Noise Floor

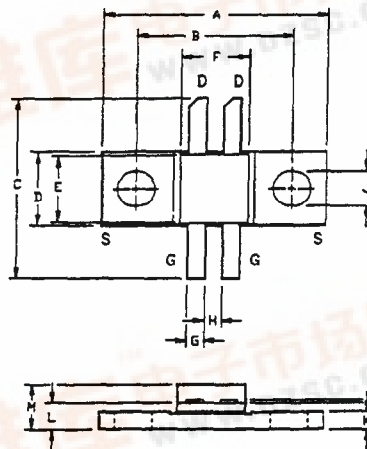

Absolute Maximum Ratings at 25°C

Parameter	Symbol	Rating	Units
Drain-Source Voltage	V_{DS}	65	V
Gate-Source Voltage	V_{GS}	20	V
Drain-Source Current	I_{DS}	4*	A
Power Dissipation	P_D	116	W
Junction Temperature	T_J	200	°C
Storage Temperature	T_{STG}	-55 to +150	°C
Thermal Resistance	θ_{JC}	1.5	°C/W

LETTER DIM	MILLIMETERS		INCHES	
	MIN	MAX	MIN	MAX
A	20.70	20.96	.815	.825
B	14.35	14.61	.565	.575
C	15.67	17.45	.617	.687
D	6.27	6.53	.247	.257
E	6.22	6.48	.245	.255
F	6.22	6.48	.245	.255
G	1.40	1.65	.055	.065
H	1.40	1.65	.055	.065
J	2.92	3.18	.115	.125
K	1.40	1.65	.055	.065
L	1.96	2.46	.077	.097
M	3.61	4.37	.142	.172
N	.08	.13	.003	.005

Electrical Characteristics at 25°C

Parameter	Symbol	Min	Max	Units	Test Conditions
Drain-Source Breakdown Voltage	BV_{DSS}	65	-	V	$V_{GS}=0.0\text{ V}, I_{DS}=5.0\text{ mA}^*$
Drain-Source Leakage Current	I_{DSS}	-	1.0	mA	$V_{DS}=28.0\text{ V}, V_{GS}=0.0\text{ V}^*$
Gate-Source Leakage Current	I_{GSS}	-	1.0	μA	$V_{GS}=20\text{ V}, V_{DS}=0.0\text{ V}^*$
Gate Threshold Voltage	$V_{GS(TH)}$	2.0	6.0	V	$V_{DS}=10.0\text{ V}, I_{DS}=100.0\text{ mA}^*$
Forward Transconductance	G_M	.5	-	S	$V_{DS}=10.0\text{ V}, I_{DS}=1000.0\text{ mA}, \Delta V_{GS}=1.0\text{ V}, 80\text{ }\mu\text{s Pulse}^*$
Input Capacitance	C_{ISS}	-	45	pF	$V_{DS}=28.0\text{ V}, F=1.0\text{ MHz}^*$
Output Capacitance	C_{OSS}	-	30	pF	$V_{DS}=28.0\text{ V}, F=1.0\text{ MHz}^*$
Reverse Capacitance	C_{RSS}	-	8	pF	$V_{DS}=28.0\text{ V}, F=1.0\text{ MHz}^*$
Power Gain	G_P	10	-	dB	$V_{DD}=28.0\text{ V}, I_{DO}=500.0\text{ mA}, P_{OUT}=40.0\text{ W}, F=500\text{ MHz}$
Drain Efficiency	η_D	50	-	%	$V_{DD}=28.0\text{ V}, I_{DO}=500.0\text{ mA}, P_{OUT}=40.0\text{ W}, F=500\text{ MHz}$
Load Mismatch Tolerance	VSWR-T	-	20:1	-	$V_{DD}=28.0\text{ V}, I_{DO}=500.0\text{ mA}, P_{OUT}=40.0\text{ W}, F=500\text{ MHz}$

* Per Side

Specifications Subject to Change Without Notice.

MA-COM, Inc.

North America: Tel. (800) 366-2266
Fax (800) 618-8883

Asia/Pacific: Tel. +81 (03) 3226-1671
Fax +81 (03) 3226-1451

Europe: Tel. +44 (1344) 869 595
Fax +44 (1344) 300 020

Typical Broadband Performance Curves

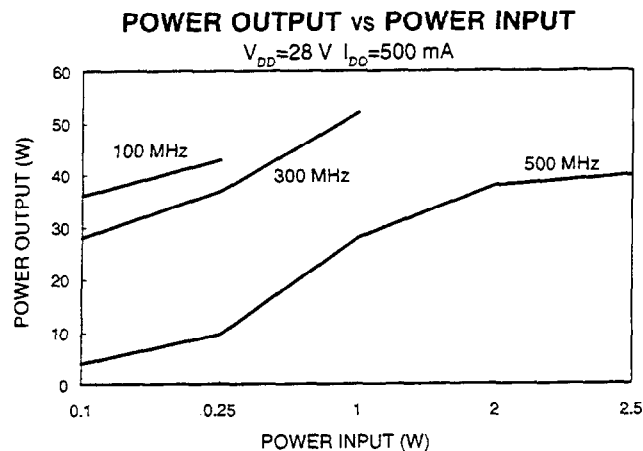
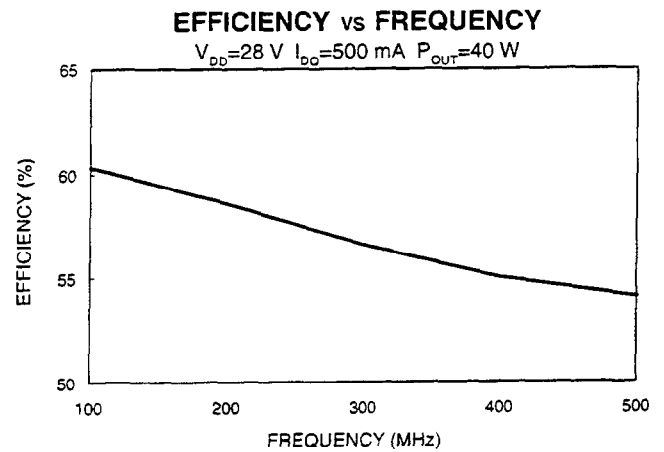
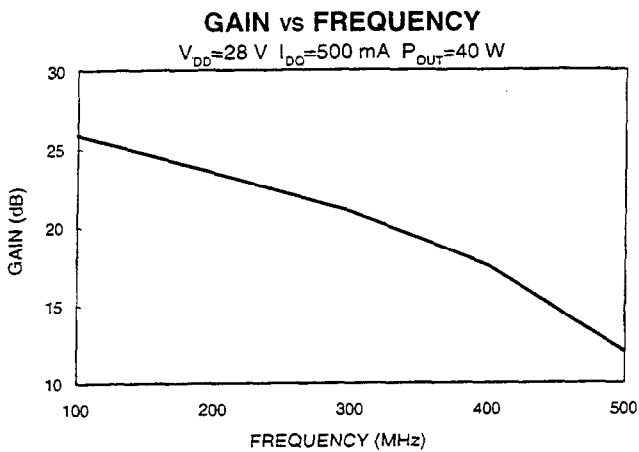
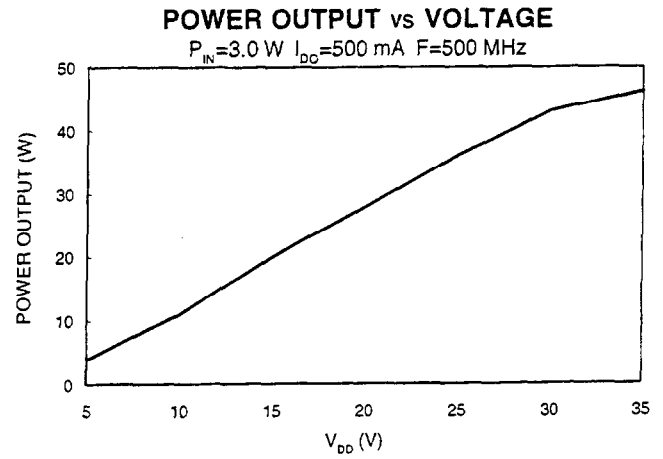
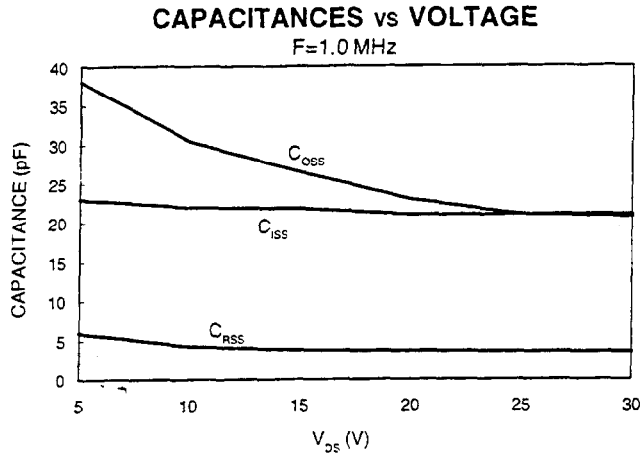

Specifications Subject to Change Without Notice.

M/A-COM, Inc.

North America: Tel. (800) 366-2266
 Fax (800) 618-8883

■ Asia/Pacific: Tel. +81 (03) 3226-1671
 Fax +81 (03) 3226-1451

■ Europe: Tel. +44 (1344) 869 595
 Fax +44 (1344) 300 020

Typical Device Impedance

Frequency (MHz)	Z _{IN} (OHMS)	Z _{LOAD} (OHMS)
100	6.0 - j 20.0	25.0 + j 27.0
300	2.5 - j 5.5	13.0 + j 13.0
500	4.0 + j 3.0	12.0 + j 5.0

V_{DD}=28 V, I_{DD}=500 mA, P_{OUT}=40.0 Watts

Z_{IN} is the series equivalent input impedance of the device from gate to gate.

Z_{LOAD} is the optimum series equivalent load impedance as measured from drain to drain.

RF Test Fixture

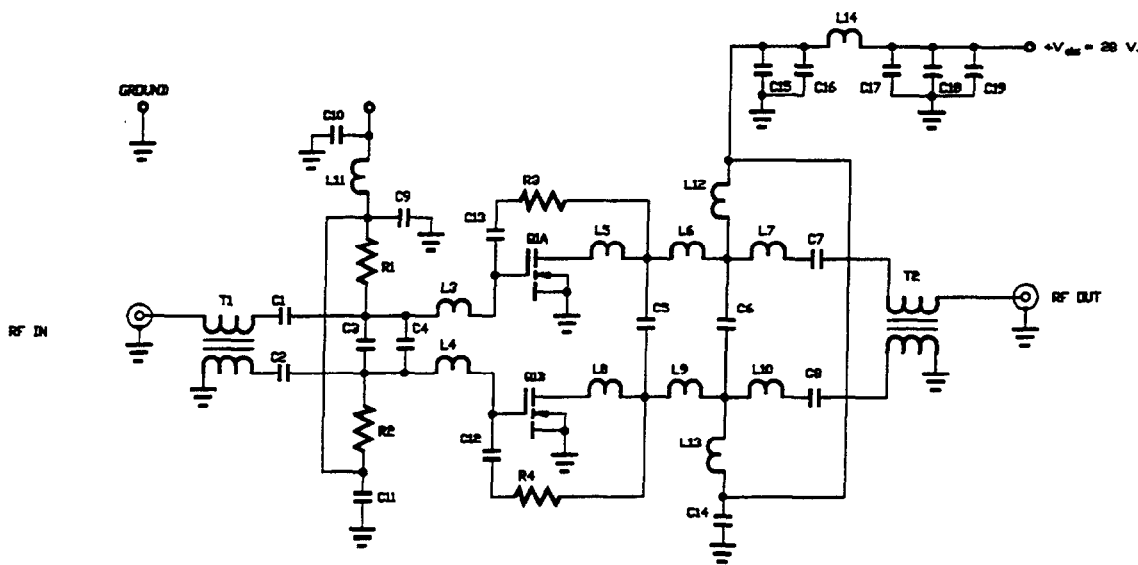

PARTS LIST

- C3, 5 10.0 pf
- C6 11.0 pf
- C4 18 pf
- C1, 2, 7, 8, 12, 13 470 pf
- C7, 9, 10 .015 uf
- C18 10 uf
- C16 1.0 uf
- C19 50 uf 50 V.
- R1, 2 100 OHM 25 W.
- R3, 4 270 OHM 25 W.
- T1, 2 2.50' OF 25 OHM SEMI-RIGID COAX
- L1, 14 7 TURNS OF NO. 22 AVG WIRE
- L12, 13 15 TURNS OF NO. 22 AVG WIRE
- L7, 10 15' OF 50 OHM TRANSMISSION LINE
- L6, 9 25' OF 50 OHM TRANSMISSION LINE
- L5, 8 30' OF 50 OHM TRANSMISSION LINE
- L4 35' OF 50 OHM TRANSMISSION LINE
- L1, 2 50' OF 50 OHM TRANSMISSION LINE
- R1 UF2840P