



T-75-07-07

UM91265 15 Memory Tone/Pulse Dialer

Features

- Tone/Pulse Switchable Dialer
- Stores ten 16-digit numbers for repertory dialing
- Additional four 16-digit numbers for emergency calls and long distance service company access code.
- One 31-digit Redial Memory
- Dialing length is unlimited, but if the normal dialing length of 31 digits is overstepped, then redial is inhibited
- Auto Pause Access for PBX and toll service operations; 3.1 seconds per pause
- Easy operation with Redial, Store, Auto and Pause keypads
- Key-tone output for valid keypad entry recognition
- Uses Form A keyboard or the standard 2-of-9 Matrix keyboard
- Electronic keypad input is available; low action
- Uses inexpensive 3.579545 MHz Television Color-burst crystal
- Pin selectable for make/break ratio
- Power-on reset is internally generated
- Memory Retention Current is less than $0.2\mu A$ at $V_{DD} = 1.0V$, on hook
- Wide operating voltage range: 2.0V to 5.5V
- Automatic switching from Pulse mode to Tone mode in long distance memory



General Description

The UM91265 is a monolithic integrated circuit which performs 15-memory tone/pulse switchable dialing functions for modern telephone set design. It is fabricated in CMOS technology and thus provides good performance in low voltage, low power operations. Four 16-digit direct dialing memories have been added for convenient em-

ergency calls (such as fire, police, doctor, etc.) and long distance service company access code operations (such as MCI and SPRINT). A wide operating voltage range and low memory retention current facilitate this chip's excellent battery-free, direct line-powered operation.

Pin Configuration & Keyboard Assignments

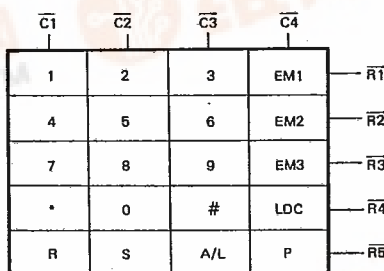
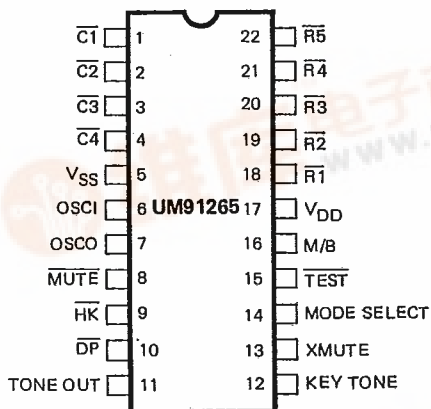

LDC: Long Distance Company
 R : Redial
 S : Store
 A/L : Auto-Dial/Location
 P : Pause





UM91265

T-75-07-07

Block Diagram

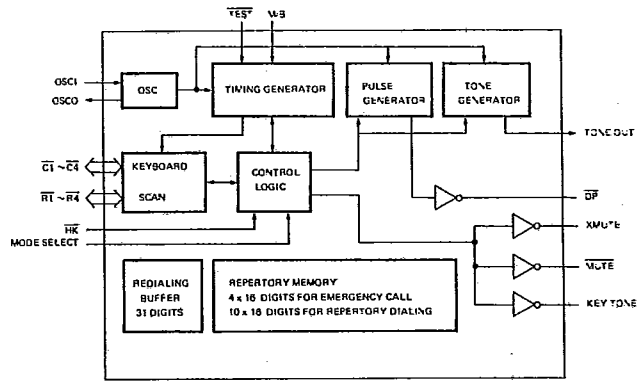

Absolute Maximum Ratings*

- DC Supply Voltage, V_{DD} 6.0V
- Input Voltage Range, V_I $-0.3V$ to $V^+ - 0.3V$
- Power Dissipation Per Package, P_O (for $T_P = -25^\circ C$ to $60^\circ C$) 500mW
- Operating Temperature, T_P $-25^\circ C$ to $85^\circ C$
- Storage Temperature, T_{stg} $-65^\circ C$ to $+150^\circ C$

*Comments

Stresses above those listed under "Absolute Maximum Ratings" may cause permanent damage to the device. These are stress ratings only. Functional operation of this device at these or any other conditions above those indicated in the operational sections of this specification is not implied and exposure to absolute maximum rating conditions for extended periods may affect device reliability.

DC Characteristics ($V_{DD} = 3.5V, V_{SS} = 0V, F_{OSC} = 3.8 MHz, T_{OP} = 25^\circ C$ unless otherwise specified)

Parameter	Symbol	Limit			Unit	Conditions	Test Ckt
		Min.	Typ.	Max.			
Operating Voltage	V_{DD}	2.0	—	5.5	V	Tone	
		2.0	—	5.5	V	Pulse	
		1.0	—	5.5	V	Memory	
Operating Current	I_{DD}	—	0.6	2	mA	Tone Notes 1, 4, 6	1
		—	0.2	0.5	mA	Pulse	
Memory Retention Current	I_R	—	0.1	0.2	μA	$\overline{HK} = 1, T_A = 45^\circ C, V^+ = 1.0V$	2
Standby Current	I_S	—	0.1	5	μA	Notes 1, 2, 3, 5, 6	1
Tone Output Voltage	V_{TO}	130	150	170	mVrms	Row Group, $R_L = 10 K\Omega$	3
Pre-emphasis		1	2	3	db	Column Group/Row Group $V_{DD} = 2.0$ to $5.5V$	4
DTMF Distortion	T_{HD}	—	-30	-23	db	$R_L = 10 K\Omega$, Notes 7, 8	4
Tone Output External Load Impedance	R_L	10	—	—	$K\Omega$	$THD \leq -23db$	
Tone Output DC Level	V_{DD}	0.5	—	0.6	V^+	$V_{DD} = 2.5 - 5.5V$	4
Tone Output Sink Current	I_{TL}	0.2	—	—	mA	$V_{TO} = 0.5V$	5
Pulse Output Source Current	$ I_{PH} $	0.2	—	—	mA	$V_{PO} = 2.0V$	5
Sink Current	I_{PL}	0.2	—	—		$V_{PO} = 0.5V$	6



UM91265

T-75-07-07

DC Characteristics (Continued)

Parameter	Symbol	Limit			Unit	Conditions	Test Ckt.
		Min.	Typ.	Max.			
Mute Output Source Current	I_{MH}	0.2	-	-	mA	$V_{MO} = 2.0V$	5
Sink Current	I_{ML}	2	-	-		$V_{MO} = 0.5V$	
Key Tone Output Source Current	I_{KH}	0.5	-	-	mA	$V_{KO} = 2.0V$	8
Sink Current	I_{KL}	0.5	-	-		$V_{KO} = 0.5V$	5
XMT Mute Source Current	I_{LH}	0.2	-	-	mA	$V_{LO} = 2.0V$	5
Sink Current	I_{IL}	0.2	-	-		$V_{LO} = 0.5V$	
Input Voltage Low	V_{IL}	GND	-	0.3	V+	Pins 1-4, 9, 14, 15	
Input Voltage High	V_{IH}	0.7	-	-		16 & 18-22	
Keypad Input Source Current	I_{KD}	4	10	30	μA	$V_I = 0V$	6
Sink Current	I_{KS}	200	400	-	-	$V_I = 2.5V$	5, 7
Control Pin Input Leakage Current	I_{IN}	-	$\pm 10^{-5}$	± 0.1	μA	Pins 9, 14, 15, 16	

Tone/Pulse Dialer

- Note 1: $\overline{HK} = 0$
- Note 2: In DTMF Mode
- Note 3: In Pulse Mode
- Note 4: Keyboard Entry, Including Auto Dialing
- Note 5: No Keyboard Entry
- Note 6: All Outputs Unloaded
- Note 7: Dual Tone Multi-Frequency Distortion is measured in terms of total out-of-band power related to sum of row and column fundamental power.
- Note 8: Crystal parameters defined as $R_s \leq 100\Omega$, $L_m = 96mH$, $C_m = 0.25 pF$, $C_h = 5 pF$, $F = 3.579545 MHz$ and $C_L = 18 pF$ $\Delta F \leq \pm 200 PPM$

AC Characteristics

Crystal Parameter defined as $R_S \leq 100\Omega$, $L_m = 96mH$, $C_m = 0.25 pF$, $C_h = 5 pF$, $F = 3.579545 MHz$ and $C_L = 18 pF$ $\Delta F \leq \pm 200 PPM$.

Parameter	Symbol	Conditions	Min.	Typ.	Max.	Unit
Pulse						
Make/Break Ratio	M/B	M/B = Terminal = V_{DD}		2/3		
		M/B Terminal = V_{SS}		1/2		
Dial Pulse Rate	DR	\overline{TEST} Terminal = V_{DD}		10		pps
		\overline{TEST} Terminal = V_{SS}		600		
Make Time	T_M	10 pps	MB = 2/3	40		mS
			MB = 1/2	33.3		
		600 pps	MB = 2/3	0.667		
			MB = 1/2	0.556		



UM91265

T-75-07-07

AC Characteristics (Continued)

Parameter	Symbol	Conditions	Min.	Typ.	Max.	Unit
Break Time	T_B	10 pps	MB = 2/3		60	mS
			MB = 1/2		66.6	
		600 pps	MB = 2/3		1	
			MB = 1/2		1.111	
Inter-Digit Pause Time	T_{IDP}	10 pps	MB = 2/3		800	mS
			MB = 1/2		800	
		600 pps	MB = 2/3		13.3	
			MB = 1/2		13.3	
Pre-Digit Pause	T_{PDP}	10 pps	MB = 2/3		40	mS
			MB = 1/2		33.3	
		600 pps	MB = 2/3			
			MB = 1/2			
MUTE Delay	T_{MDP}	10 pps	MB = 2/3		40	mS
			MB = 1/2		33.3	
		600 pps	MB = 2/3			
			MB = 1/2			
-tone						
Minimum Tone Duration	T_{MFD}			100		mS
Minimum Tone Inter-Digit Pause	T_{TIDP}			105		mS
Key-In						
Key-In Debounce Time	T_{KD}	$\overline{\text{TEST}} = V_{DD}$		20		mS
Key-Release Debounce Time	T_{KR}			20		mS
Key Tone						
Key-Tone Frequency	F_{KS}	$C1 \sim C4, R1 \sim R5$		1.2		KHz
Row, Column Frequency						
R/C	Spec.	Actual	Error (%)	Unit		
R1	697	699	+0.29	Hz		
R2	770	766	-0.78	Hz		
R3	852	848	-0.47	Hz		
R4	941	948	+0.74	Hz		
C1	1209	1216	+0.58	Hz		
C2	1336	1332	-0.30	Hz		
C3	1477	1472	-0.34	Hz		



UM91265

T-75-07-07

Pin Description

Pin No.	Symbol	I/O	Description
1-4 18-22	$\overline{C1} \sim \overline{C4}$ $\overline{R1} \sim \overline{R5}$	I/O	The keypad input is compatible with the standard 2-of-9 keyboard, the inexpensive single-contact (Form A) keyboard, and electronic inputs. Figure 1 shows how to connect the two keyboard types and Figure 2 shows wave forms for electronic inputs. In normal operation, any single button is pushed to produce a dual tone, pulses or a function. Activation of two or more buttons will result in no response, except for a single tone. Table 1 illustrates the address keypad function, in detail.
6 7	OSCI OSCO		A built-in inverter provides oscillation with an inexpensive 3.579545 MHz television color-burst crystal. The oscillator ceases when a keypad input is not sensed. An on-board counter is used to decrease the frequency of the oscillator and creates crystal debounce, mute delay, predigit pause, pulse rate, interdigit pause, Make/Break ratio, intertone pause, tone duration, row group and column group frequency, and key tone frequency oscillation. Any crystal frequency deviation from 3.579545 MHz will be reflected in the time parameter above. Most crystals do not vary more than ± 0.02 percent.
8	\overline{MUTE}	O	The mute is a conventional CMOS inverter that pulls to positive voltage with no keyboard input and pulls to ground when an address keypad entry is sensed (excluding the * and # keypads in pulse mode), that is, when any keypad in row 5 and column 4 is pushed, then mute out remains at high level. The mute output is used to cut out the current biased in type-2500 telephone circuit that is required to actuate upon address keypad input.
9	\overline{HK}	I	The \overline{HK} (Hook Switch) input is used to sense the state of the handset as On-hook or Off-hook. In the On-hook state, $\overline{HK} = 1$, the keyboard input is disabled. There is no operation for any keyboard entry. This avoids energy loss to the capacitor. In the Off-hook state, $\overline{HK} = 0$, all of the functions work.
10	\overline{DP}	O	In the DTMF mode, the pulse out remains high regardless of keyboard entry. In the pulse mode, this output sends a chain of pulses to the corresponding keypad input address, but remains high for * and # entries. Figure 3 shows the timing diagram in pulse mode. Under normal conditions, the pulse rate and interdigit pause are fixed, Pin 15 = 1, and will be 10 pps and 800 ms respectively. The Make/Break ratio is pin selectable and depends on the state of the M/B pin. It is 60:40 for M/B = 1 and 66.6:33.3 for M/B = 0.
11	TONE OUT	O	This pin is used to send out the DTMF address code. During pulse dialing, it always remains in a low state, regardless of keypad input. In the tone mode, it will put out a single or dual tone. For a detailed description, please refer to Table 1. In normal dialing,, the tone duration depends on the length of key-in. When a keypad is held down less than 100 ms, the tone duration will remain fixed at 100 ms. If it is held down longer, the tone duration will last as long as key-in continues. The intertone pause will be different under the following conditions: when key release lasts less than 105 ms, the pause will be fixed at 105 ms; otherwise, it will be equal to the length of time the key was released. When redialing, the tone duration and intertone pause are internally set at 100 ms and 105 ms, respectively. Detailed timing diagrams of the tone modes are shown in Figures 4-(a) and (b).

Tone/Pulse Dialer



UM91265

T-75-07-07

Pin Description (Continued)

Pin No.	Symbol	I/O	Description
12	KEY TONE	O	The key tone is from a conventional CMOS inverter. An NPN transistor is needed to drive the piezo. The output frequency is 1.2 KHz. No matter whether it is in DTMF or Pulse mode, the key tone will be accurate for any keypad entry (including row 5 and column 4) that is detected and will cease when the button is released. There will be no key tone output when two or more buttons on the keyboard are pushed simultaneously.
13	XMUTE	O	The XMUTE is a conventional CMOS inverter. An NPN transistor is used to turn off the LED. In the DTMF mode, output is actuated for the duration of DTMF signal transmission. But output remains low in pulse mode. In addition to controlling LED indication, it can also be used for muting operation in the Tone mode.
14	MODE SELECT	I	Pulls Pin 14 to V_{DD} when the dialer is in Pulse mode. Otherwise, it is in DTMF mode.
15	$\overline{\text{TEST}}$	I	In normal operation, the $\overline{\text{TEST}}$ pin is tied to V_{DD} , the single tone is inhibited and the pulse rate is 10 pps. During testing, the $\overline{\text{TEST}}$ pin is tied to ground, a single tone can be created by the method shown in Table 1, and all of the time parameters for pulse dialing are 60 times faster.
16	M/B	I	The Make/Break ratio is 2/3, if $M/B = 1$ and is 1/2 if $M/B = 0$. This pin influences nothing in the DTMF mode.
17 5	V_{DD} V_{SS}		Power supply pins. Operating voltage range: 2.0V ~ 5.5V

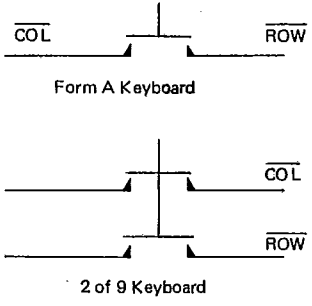

Figure 1. KEYBOARD CONFIGURATIONS

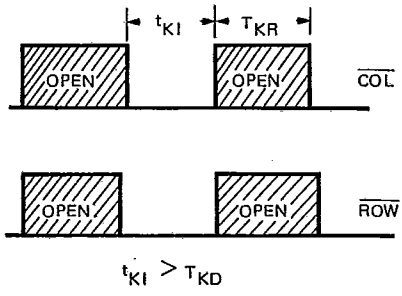

Figure 2. ELECTRONIC INPUTS



UM91265

T-75-07-07

Table 1. Address Keypad Truth Table

Output		Active Low Inputs		Output Tone (Pin 11) Pulse (Pin 10)
		ROW (Pins 18-21)	COLUMN (Pins 1-3)	
Tone (Pin 14 = 0)	Normal (Pin 15 = 1)	One	One	Dual Tone
		Two or more	One	Pin 11 = 0
		One	Two or more	
		Two or more	Two or more	
	Single Tone (Pin 15 = 0)	One	One	Dual Tone
		Two or more	One	Column Tone
		One	Two or more	Row Tone
		Two or more	Two or more	Pin 11 = 0
Pulse (Pin 14 = 1)	10 pps (Pin 15 = 1)	One	One	10 pps
		Two or more	One	Pin 10 = 1
		One	Two or more	
		Two or more	Two or more	
Pulse (Pin 14 = 1)	600 pps (Pin 15 = 0)	One	One	600 pps
		Two or more	One	Pin 10 = 1
		One	Two or more	
		Two or more	Two or more	

Tone/Pulse
Dialer

- Note 1: In pulse mode, Pin 10 = 1 for * and # buttons.
 Note 2: In pulse mode, Pin 11 always equals 0. In DTMF mode, Pin 10 always equals 1.
 Note 3: Pin 10 = 1, Pin 11 = 0 for any button in Row 5 and Column 4, regardless of mode.

Operational Procedures

Symbol definitions

- a. Dp: Pulse digit: 0, 1, 2, 3, 4, 5, 6, 7, 8, 9
- b. Dt: Tone digit, 0, 1, 2, 3, 4, 5, 6, 7, 8, 9, *, #.
- c. LOCi: Location i, i = 0, 1, 2, 3, 4, 5, 6, 7, 8, 9
- d. ZiZiZi: conversation
- e. 0-0 ↓: ON-HOOK
- f. 0-0 ↑: OFF-HOOK
- g. P: Pause Key
- h. A/L: Auto-Dial/Location Key
- i. R: Redially Key.
- j. Emi: Emergency key i = 1, 2, 3.
- k. S: Store key
- l. LDC: Long Distance Call Key.

A. Normal dialing

- 1. Pulse mode

- 0-0 ↑, DpDp... ZiZiZi 0-0 ↓
- 2. Tone mode
- 0-0 ↑, DtDt... ZiZiZi 0-0 ↓

B. Redialing

- 0-0 ↑ DpDp... 0-0 ↓ 0-0 ↑
- R, ZiZiZi: 0-0 ↓
- 0-0 ↑ DtDt... 0-0 ↓ 0-0 ↑
- R, ZiZiZi: 0-0 ↓

C. Storing

- S, Dx Dx Dx... S, LOCi,

D. Memory dialing

- 0-0 ↑ A/L, LOCi, ZiZiZi, 0-0 ↓

E. Pause Key Operation

- 1. Storing with pause
- S, Dx Dx Dx... P, Dx Dx Dx... S, LOCi



UM91265

T-75-07-07

2. Dialing with Pause

0-0 ↑ A/L, LOCi, ZiZiZi, 0-0 ↓

Note: Every pause occupies one digit. Pause digit can be stored many times.

F. Emergency dialing

1. Storing emergency numbers.

S, Dx Dx Dx . . . , S, Emi

2. Emergency dialing

0-0 ↑, Emi, ZiZiZi, 0-0 ↓

G. Long distance service memory dialing

The UM91265 provides a special memory location for storing a long distance service company access code. It also provides an automatic switching function which

changes from Pulse mode to Tone mode after a pause.

This function makes it easier for a subscriber to use a long distance service company (such as MCI or SPRINT) without confusing the Pulse/Tone switching operation.

1. Storing the long distance service company code, to LDC memory.

S, Dx Dx Dx . . . , P, P, Dx Dx Dx . . . S, LDC

Two Pause Authorized Access codes.

2. LDC dialing

0-0 ↑, LDC, ZiZiZi 0-0 ↓

Note: The chip will automatically switch to tone mode after the two pause duration (6.2ms) even if the Authorized Access Codes you Store are pulse codes.

Timing Waveforms

(1) PULSE MODE TIMING

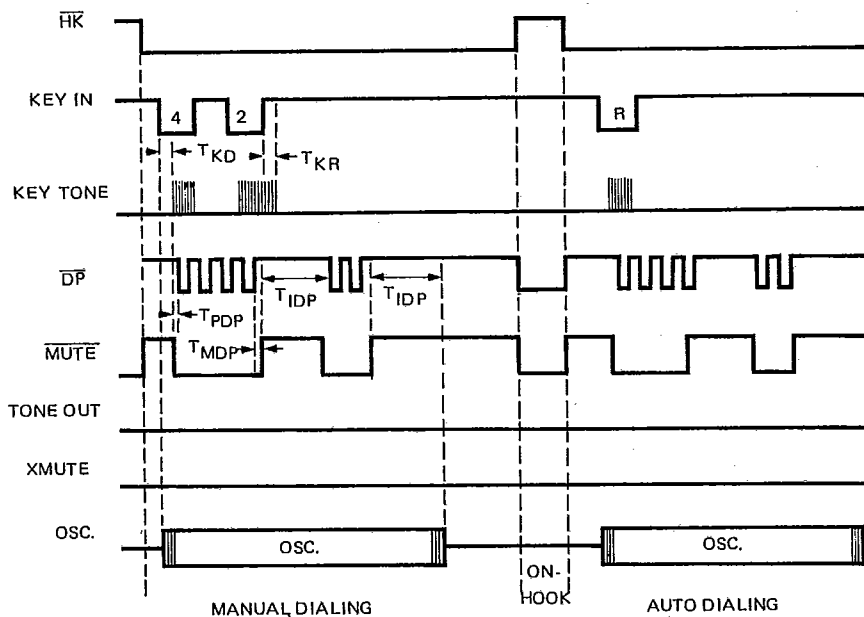



UM91265

T-75-07-07

(2) TONE MODE TIMING

(a) NORMAL

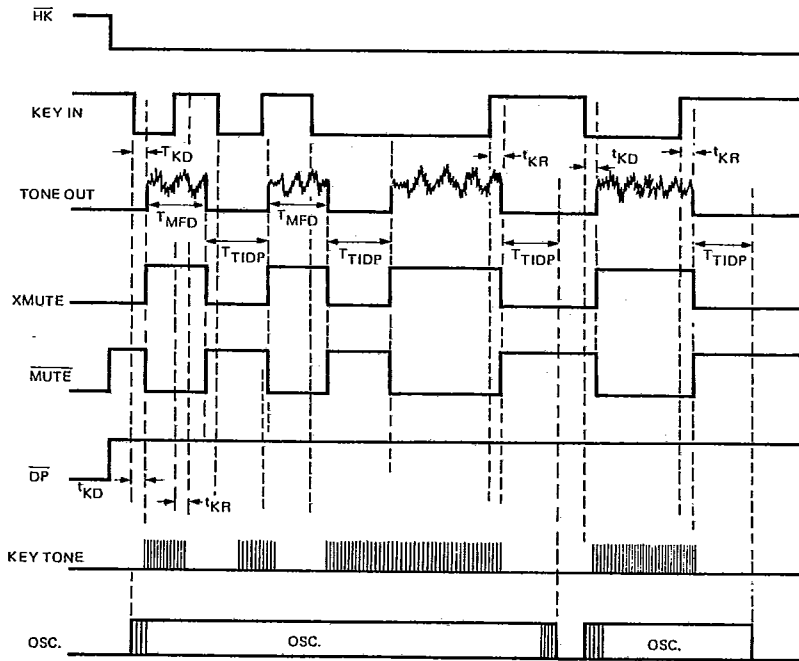

(b) REDIALING

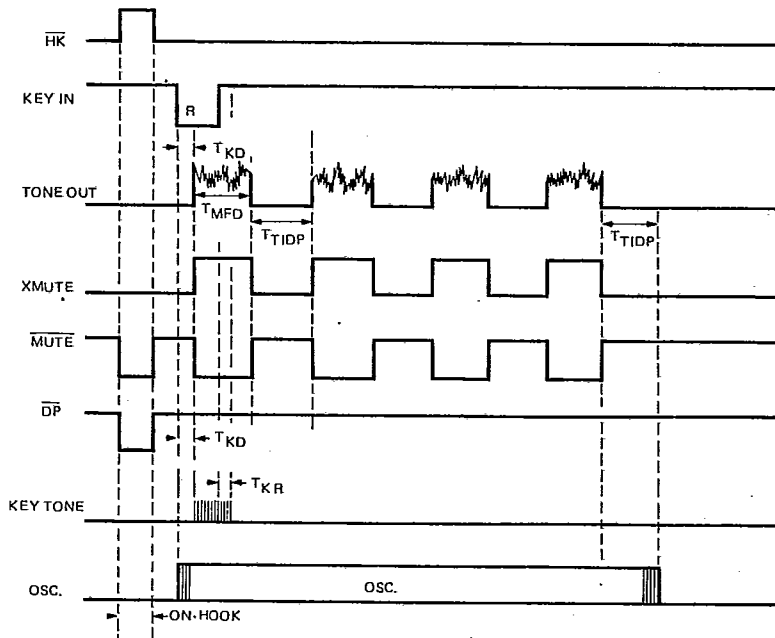



UM91265

T-75-07-07

Typical Application Circuit

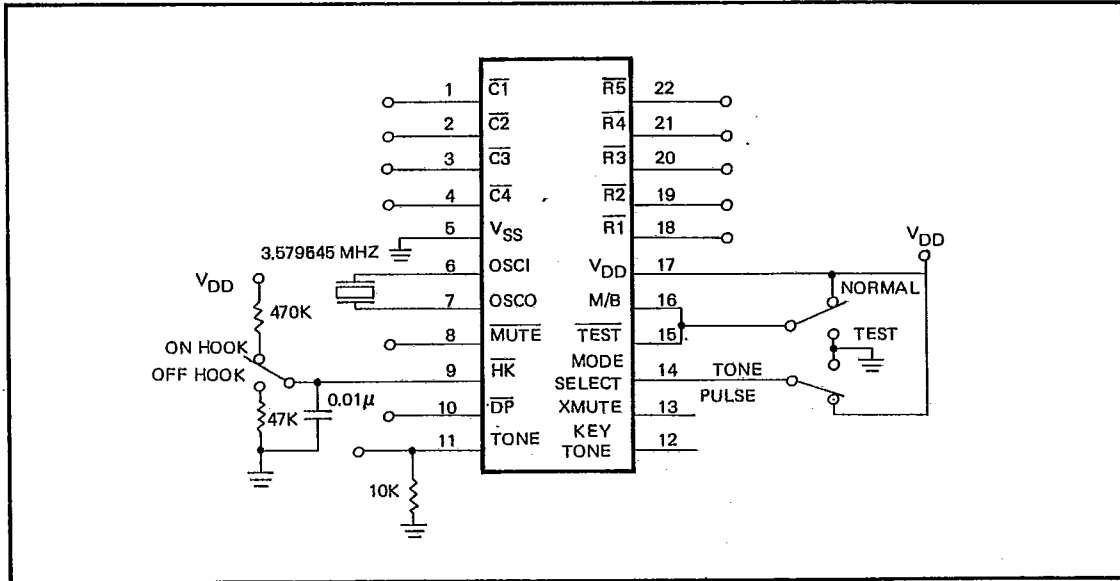

Typical Application Circuit

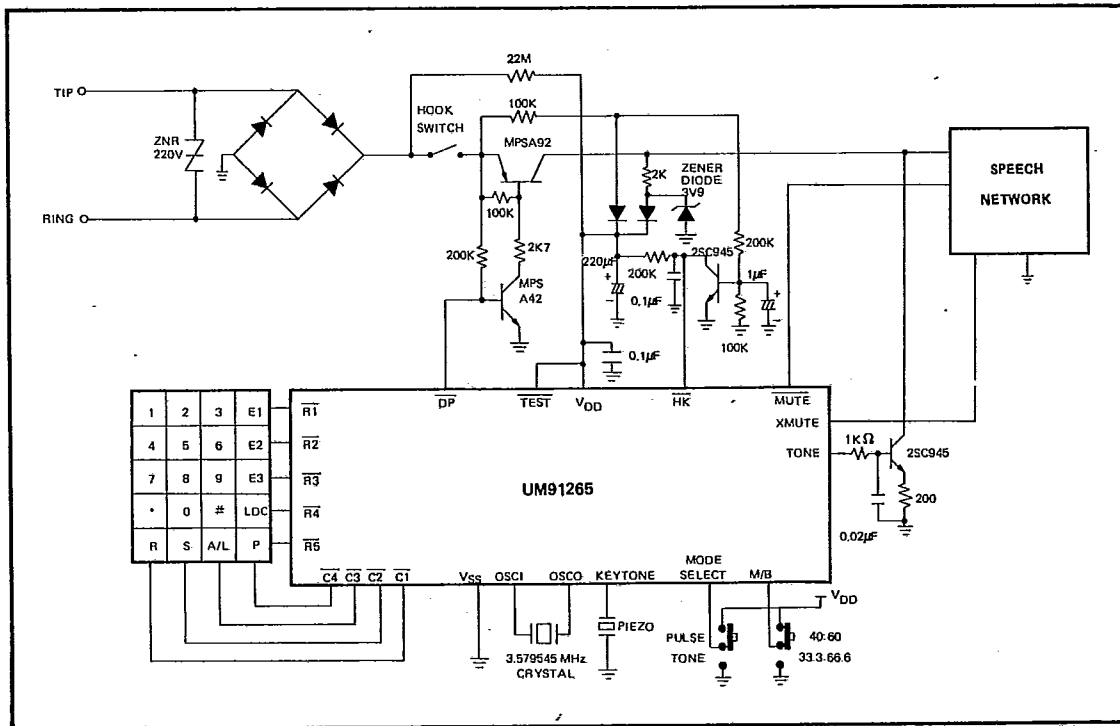



UM91265

T-75-07-07

Test Circuits

1.

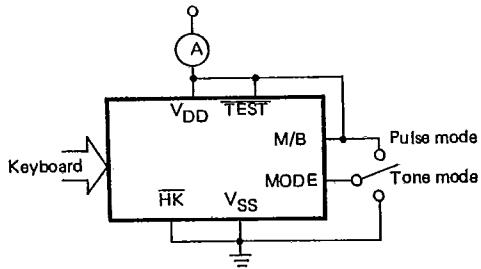

2.

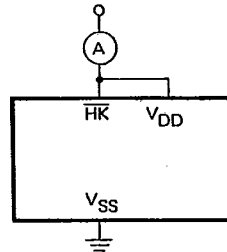

Tone/Pulse Dialer

3.

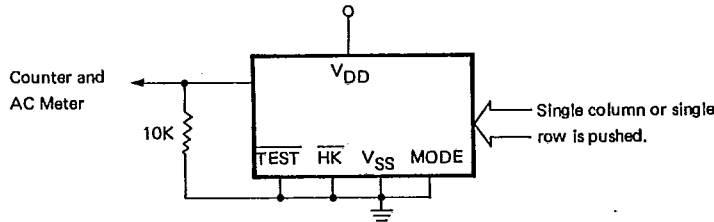

4.

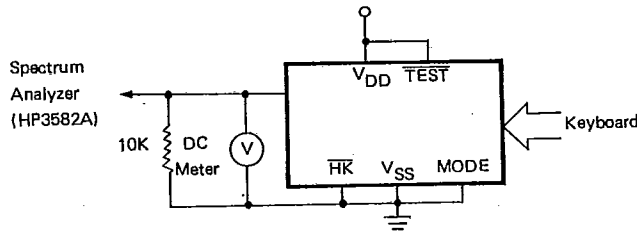

$$DIST_{db} = 20 \log \frac{\sqrt{(V_1)^2 + (V_2)^2 + \dots + (V_n)^2}}{\sqrt{(V_L)^2 + (V_H)^2}}$$

* $V_1 \dots V_n$ are extraneous frequency (i. e. intermodulation and harmonic) components in the 500HZ to 3400HZ band.

* V_L, V_H are the individual frequency components of the DTMF signal.

Note: Whether keyboard is pushed, refer to the DTMF mode timing diagram.

5.

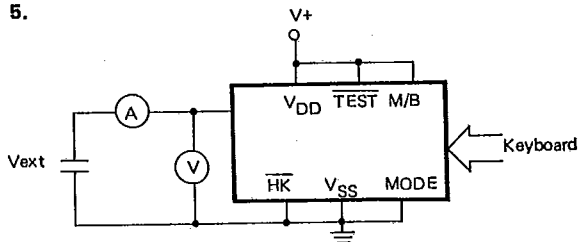

6.

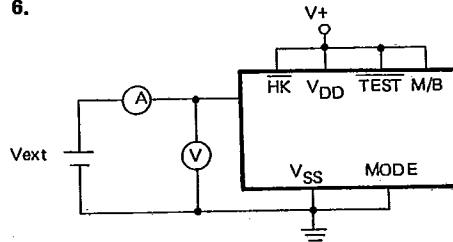

Note: Whether keyboard is pushed, refer to the DTMF mode timing diagram.



UM91265

T-75-07-07

7.

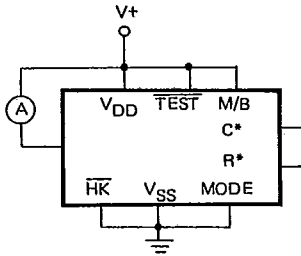

R*: any row of R1 - R6
 C*: any column of C1 - C4
 $I_{sink} = I / (1 - \text{Duty Cycle})$
 I is the net dc current.

8.

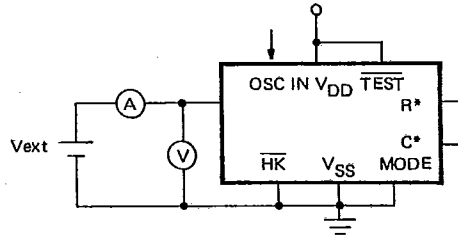

Procedure:
 1 Provide clocks until output changes to high.
 2 Test the current.
 Note: $\overline{\text{TEST}}$ pin can be combined with V_{SS} in order to speed up testing.

This datasheet has been download from:

www.datasheetcatalog.com

Datasheets for electronics components.