

PIN DIODE

UM9401
UM9402
UM9415

COMMERCIAL TWO-WAY RADIO ANTENNA SWITCH DIODES

Features

- Specified low distortion
- Microsemi ruggedness and reliability
- Low bias current requirements
- Priced for high quantity applications

Description:

Microsemi offers a series of PIN diodes specifically designed and characterized for solid state antenna switches in commercial two-way radios. Antenna switches using the UM9401 and UM9415 series PIN diodes provide high isolation, low loss and low distortion characteristics formerly possible only with electromechanical relay type switches.

The UM9401 and UM9402 diodes can handle above 100W of transmitter power,

while the UM9415 will handle over 1000W. The extensive characterization of these PIN diodes in antenna switch applications has resulted in guaranteed low distortion specifications under transmit and receive conditions. These diodes also feature low forward bias resistance and high zero bias impedance which are required for low loss, high isolation and wide bandwidth antenna switch performance.

6

MAXIMUM RATINGS

	UM9401	UM9402	UM9415
Reverse Voltage (V _R) — Volts (I _R = 10 μA)	50V	50V	50V

Average Power Dissipation (P_A) Lead Length — ½ in. (12.7mm) Total to 25°C Contacts 25°C (Package Flange) Temperature Free Air	UM9401	UM9402	UM9415
	5.5W	—	10W
	—	10W	—
	1.5W	—	2.5W

Operating and Storage Temperature Range	— 65 °C to +175 °C
--	--------------------

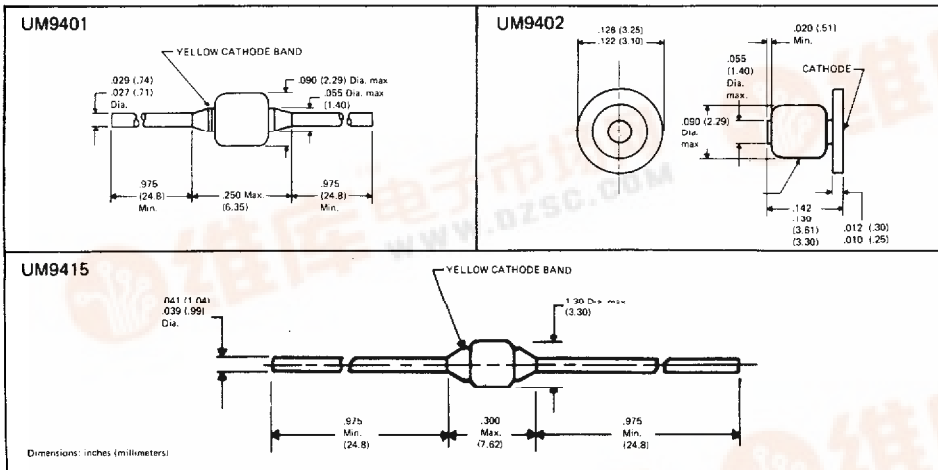

Microsemi Corp.
Watertown
The diode experts



UM9401 UM9402 UM9415

Electrical Specifications (at 25 °C)

Test	Symbol	UM9401/UM9402			UM9415			Units	Conditions
		Min	Typ	Max	Min	Typ	Max		
Series Resistance	R_S		0.75	1.0		0.75	1.0	Ω	$f = 100\text{MHz typical}$ $I = 50\text{ mA}$
Diode Capacitance	C_T		1.1	1.5			4	pF	$f = 100\text{ MHz}$ $V = 0\text{V}$
Parallel Resistance	R_P	5K	10K		1K	2K		Ω	$f = 100\text{ MHz}$ $V = 0\text{V}$
Carrier Lifetime	τ	1.0	2.0		5			μS	$I = 10\text{ mA}$
Transmit Harmonic Distortion	$\frac{R_{2A}}{A}, \frac{R_{3A}}{A}$			80			80	-dB	$P_{IN} = 50\text{W}$ $f = 50\text{ MHz}, I = 50\text{ mA}$
Receive Third Order Distortion	$\frac{R_{2AB}}{A}$			60			60	-dB	$P_{IN} = 10\text{ mW}, 0\text{V Bias}$ $f_A = 50\text{ MHz}, f_B = 51\text{ MHz}$
Reverse Leakage Current	I_R			10			10	μA	$V = 50\text{V}$
Forward Voltage	V_F			1.0			1.0	V	$I_F = 50\text{ mA}$

TYPICAL FORWARD RESISTANCE VS FORWARD CURRENT (F = 100 MHz)

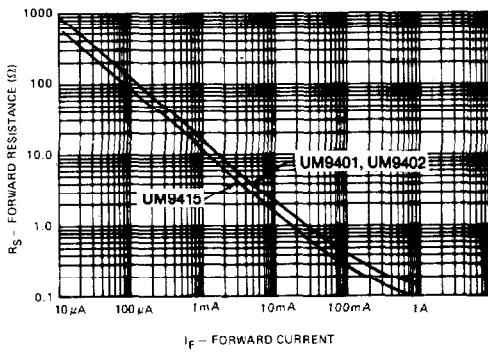

TYPICAL DC CHARACTERISTIC

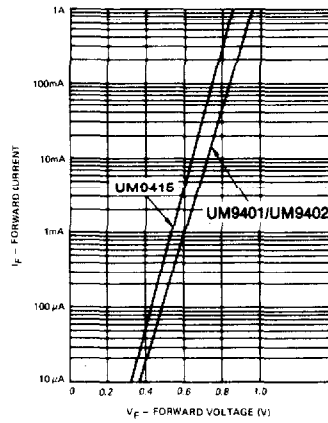

TYPICAL CAPACITANCE CHARACTERISTIC

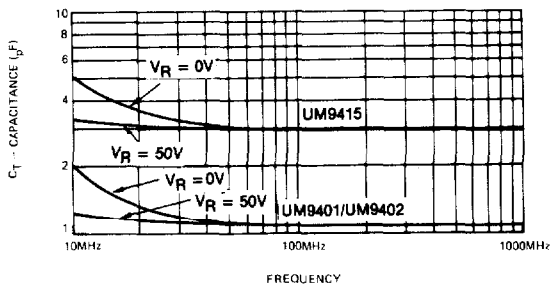

TYPICAL RP CHARACTERISTICS

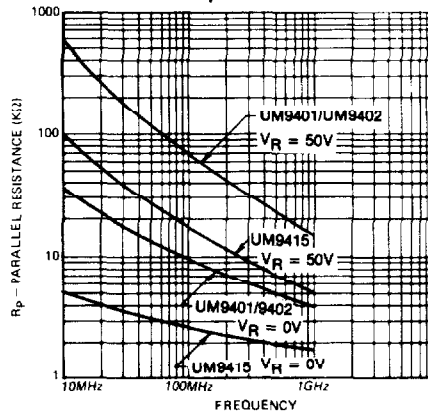

UM9401 UM9402 UM9415

6

POWER RATING
UM9415

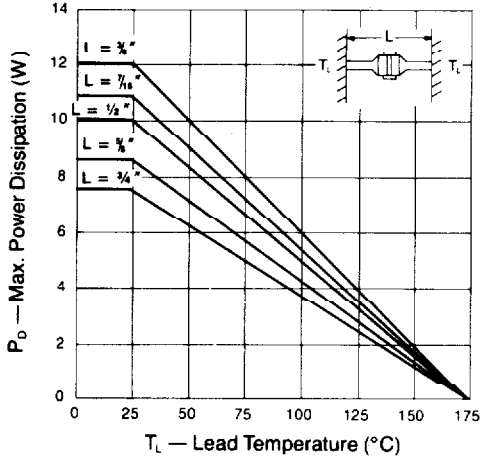

POWER RATING
UM9401/9402

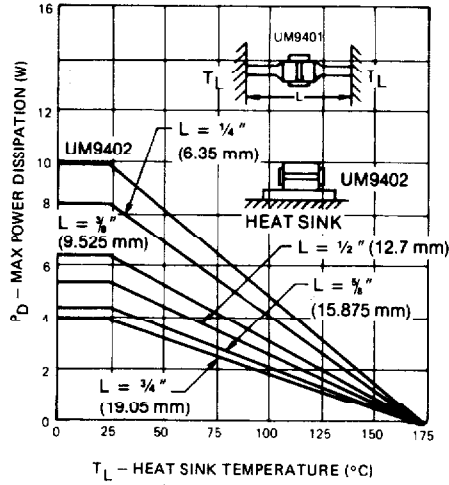

MAXIMUM TRANSMITTER POWER

UM9415

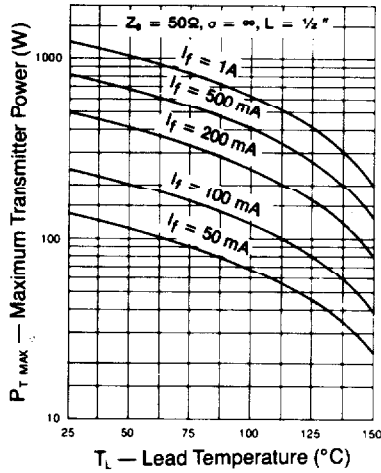

UM9401/UM9402

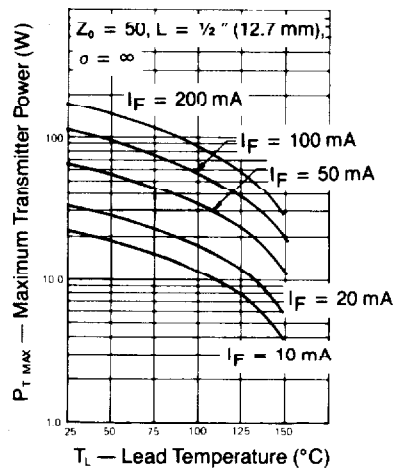

Maximum Transmitter Power

The maximum CW transmitter power, $P_{T(max)}$, a PIN diode antenna switch can handle depends on the diode resistance, R_D , power dissipation, P_D , antenna SWR, σ , and nominal impedance, Z_0 . The expression relating these parameters is as follows:

$$P_{T(max)} = \frac{P_D \times Z_0}{R_D} \left(\frac{\sigma + 1}{2\sigma} \right)^2 \text{ [Watts]}$$

Characteristic curves are shown in the data section which give both the maximum and typical diode resistance, R_D as a function of forward current. The maximum power dissipation rating of the PIN diode depends both on the length of the diode leads and the temperature of the contacts to which the leads are connected. A graph defining the maximum power dissipation at various combinations of overall lead length (L) and lead temperature (T_L) is given in the data section. From these curves and the above equation, the power handling capability of the PIN diode may be computed for a specific application.

Curves are also presented which show the maximum transmitter power that an antenna

switch using UM9401s and UM9415s can safely handle for various forward currents and lead temperatures. These curves are based on a typical design condition of a 1/2 in. total overall lead length, 50Ω line impedance and a totally mismatched antenna ($\sigma = \infty$). For the case of a perfectly matched antenna, the maximum transmitter power can be increased by a factor of 4.

Design Information

A circuit configuration for a two-way radio antenna switch using PIN diodes consists of a diode placed in series with the transmitter and a shunt diode placed a quarter wavelength from the antenna in the direction of the receiver as shown. For low frequency operation, the quarter wave line may be simulated by lumped elements. Typical performance of antenna switches using PIN diodes forward biased at 100 mA is less than 0.2 dB insertion loss and 30 dB isolation during transmit; at zero bias the receive insertion loss is less than 0.3 dB. This performance is achievable across a ±20% bandwidth at center frequencies ranging from 10 to 500 MHz.

