

# UN9211/9212/9213/9214/9215/9216/9217/9218/9219/9210/921D/ 921E/921F/921K/921L/UNR921M/921N/921AJ/921BJ/921CJ

## Silicon NPN epitaxial planer transistor

For digital circuits

### Features

- Costs can be reduced through downsizing of the equipment and reduction of the number of parts.
- SS-Mini type package, allowing automatic insertion through tape packing and magazine packing.

### Resistance by Part Number

	Marking Symbol	(R <sub>1</sub> )	(R <sub>2</sub> )
● UN9211	8A	10kΩ	10kΩ
● UN9212	8B	22kΩ	22kΩ
● UN9213	8C	47kΩ	47kΩ
● UN9214	8D	10kΩ	47kΩ
● UN9215	8E	10kΩ	—
● UN9216	8F	4.7kΩ	—
● UN9217	8H	22kΩ	—
● UN9218	8I	0.51kΩ	5.1kΩ
● UN9219	8K	1kΩ	10kΩ
● UN9210	8L	47kΩ	—
● UN921D	8M	47kΩ	10kΩ
● UN921E	8N	47kΩ	22kΩ
● UN921F	8O	4.7kΩ	10kΩ
● UN921K	8P	10kΩ	4.7kΩ
● UN921L	8Q	4.7kΩ	4.7kΩ
● UNR921M	EL	2.2kΩ	47kΩ
● UNR921N	EX	4.7kΩ	47kΩ
● UNR921AJ	8X	100kΩ	100kΩ
● UNR921BJ	8Y	100kΩ	—
● UNR921CJ	8Z	—	47kΩ

### Absolute Maximum Ratings (Ta=25°C)

Parameter	Symbol	Ratings	Unit
Collector to base voltage	V <sub>CBO</sub>	50	V
Collector to emitter voltage	V <sub>CEO</sub>	50	V
Collector current	I <sub>C</sub>	100	mA
Total power dissipation	P <sub>T</sub>	125	mW
Junction temperature	T <sub>j</sub>	125	°C
Storage temperature	T <sub>sig</sub>	-55 to +125	°C

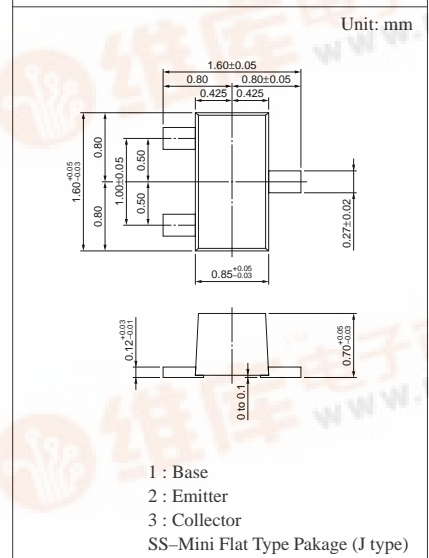
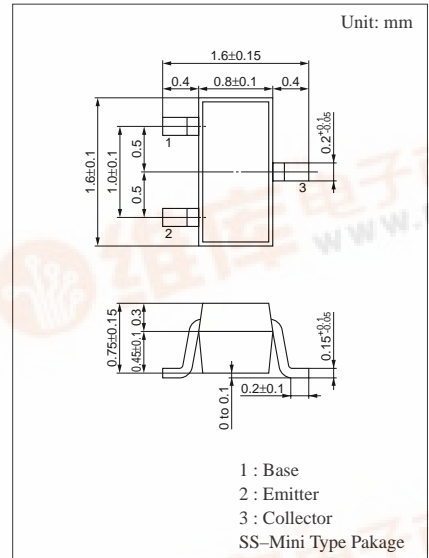

### Internal Connection

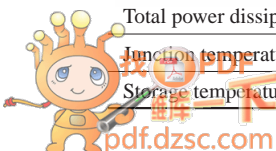
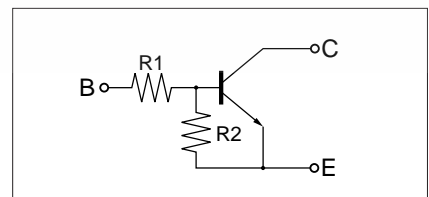

UN9211/9212/9213/9214/9215/9216/9217/9218/9219/9210/921D/  
**Transistors with built-in Resistor 921E/921F/921K/921L/UNR921M/921N/921AJ/921BJ/921CJ**

**Electrical Characteristics** (Ta=25°C)

Parameter		Symbol	Conditions	min	typ	max	Unit
Collector cutoff current		I <sub>CBO</sub>	V <sub>CB</sub> = 50V, I <sub>E</sub> = 0			0.1	μA
		I <sub>CEO</sub>	V <sub>CE</sub> = 50V, I <sub>B</sub> = 0			0.5	μA
Emitter cutoff current	UN9211	I <sub>EBO</sub>	V <sub>EB</sub> = 6V, I <sub>C</sub> = 0			0.5	mA
	UN9212/9214/921E/921D					0.2	
	UN9213/UNR921M/921N/UNR921AJ					0.1	
	UN9215/9216/9217/9210/UNR921BJ					0.01	
	UN921F/921K					1.0	
	UN9219					1.5	
	UN9218/921L/UNR921CJ					2.0	
Collector to base voltage		V <sub>CBO</sub>	I <sub>C</sub> = 10μA, I <sub>E</sub> = 0	50			V
Collector to emitter voltage		V <sub>CEO</sub>	I <sub>C</sub> = 2mA, I <sub>B</sub> = 0	50			V
Forward current transfer ratio	UN9211	h <sub>FE</sub>	V <sub>CE</sub> = 10V, I <sub>C</sub> = 5mA	35			
	UN9212/921E			60			
	UN9213/9214/921M/UNR921AJ/921CJ			80			
	UN9215*/9216*/9217*/9210*/UNR921BJ			160		460	
	UN921F/921D/9219			30			
	UN9218/921K/921L			20			
	UN921N			80		400	
Collector to emitter saturation voltage		V <sub>CE(sat)</sub>	I <sub>C</sub> = 10mA, I <sub>B</sub> = 0.3mA			0.25	V
Output voltage high level		V <sub>OH</sub>	V <sub>CC</sub> = 5V, V <sub>B</sub> = 0.5V, R <sub>L</sub> = 1kΩ	4.9			V
Output voltage low level		V <sub>OL</sub>	V <sub>CC</sub> = 5V, V <sub>B</sub> = 2.5V, R <sub>L</sub> = 1kΩ			0.2	V
			V <sub>OC</sub> = 5V, V <sub>B</sub> = 3.5V, R <sub>1</sub> = 1kΩ			0.2	
			V <sub>CC</sub> = 5V, V <sub>B</sub> = 10V, R <sub>1</sub> = 1kΩ			0.2	
			V <sub>CC</sub> = 5V, V <sub>B</sub> = 6V, R <sub>L</sub> = 1kΩ			0.2	
			V <sub>CC</sub> = 5V, V <sub>B</sub> = 5V, R <sub>L</sub> = 1kΩ			0.2	
Transition frequency		f <sub>T</sub>	V <sub>CB</sub> = 10V, I <sub>E</sub> = -2mA, f = 200MHz		150		MHz
Input resistance	UN9211/9214/9215/921K	R <sub>1</sub>		(-30%)	10	(+30%)	kΩ
	UN9212/9217				22		
	UN9213/921D/921E/9210				47		
	UN9216/921F/921L/UNR921N				4.7		
	UN9218				0.51		
	UN9219/UNR921M				1		
	UNR921AJ/921BJ				100		

\* h<sub>FE</sub> rank classification (UN9215/9216/9217/9210)

Rank	Q	R	S
h <sub>FE</sub>	160 to 260	210 to 340	290 to 460

UN9211/9212/9213/9214/9215/9216/9217/9218/9219/9210/921D/  
**Transistors with built-in Resistor 921E/921F/921K/921L/UNR921M/921N/921AJ/921BJ/921CJ**

■ **Electrical Characteristics (continued)** (Ta=25°C)

Parameter		Symbol	Conditions	min	typ	max	Unit
Resistance ratio	UN9211/9212/9213/921L	R <sub>1</sub> /R <sub>2</sub>		0.8	1.0	1.2	
	UN9214			0.17	0.21	0.25	
	UN9218/9219			0.08	0.1	0.12	
	UN921D				4.7		
	UN921E				2.14		
	UN921F				0.47		
	UN921K				2.13		
	UN921M				0.047		
	UN921N				0.1		
	UNR921AJ				1.0		
Resistance between Emitter to Base	UNR921CJ	R <sub>2</sub>		-30%	47	30%	kΩ

UN9211/9212/9213/9214/9215/9216/9217/9218/9219/9210/921D/  
**Transistors with built-in Resistor 921E/921F/921K/921L/UNR921M/921N/921AJ/921BJ/921CJ**

Common characteristics chart

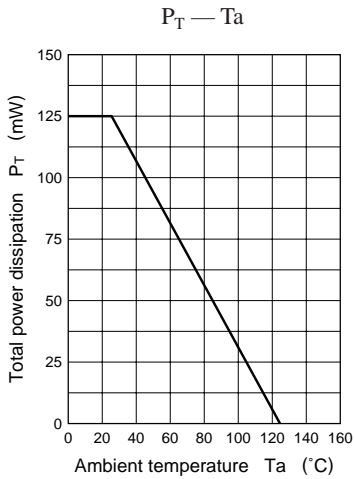

Characteristics charts of UN9211

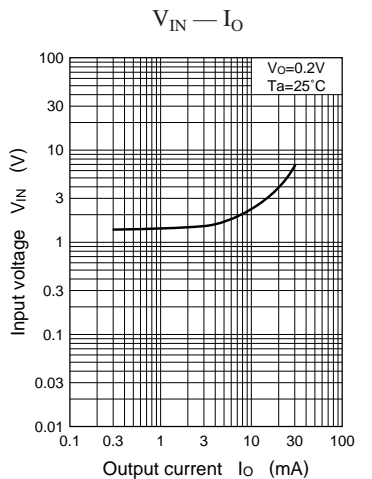
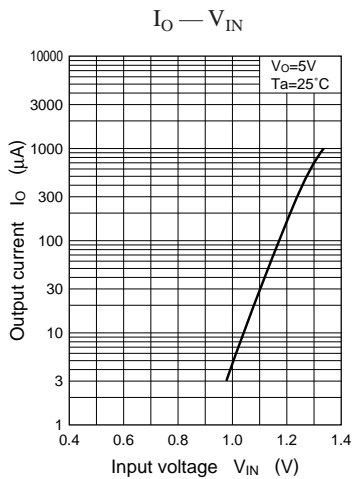
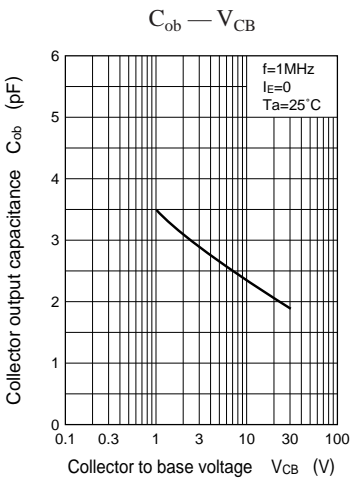
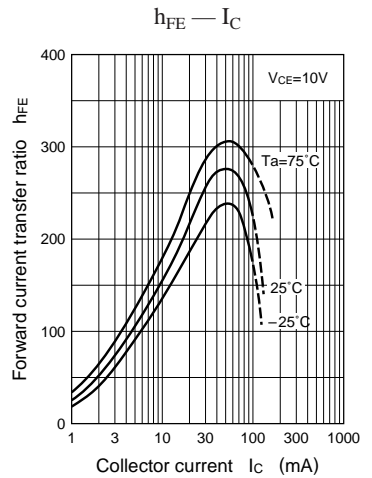
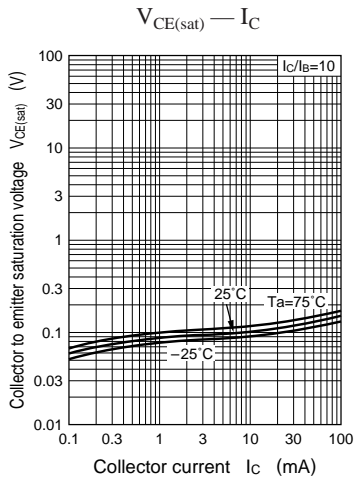
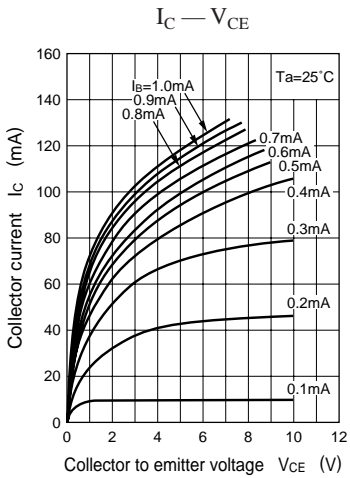

UN1211/1212/1213/1214/1215/1216/1217/1218/  
 Transistors with built-in Resistor 1219/1210/121D/121E/121F/121K/121L

Characteristics charts of UN9212

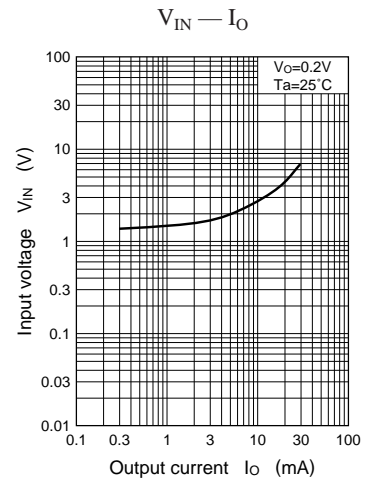
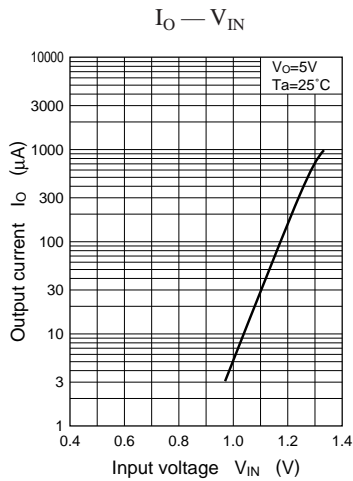
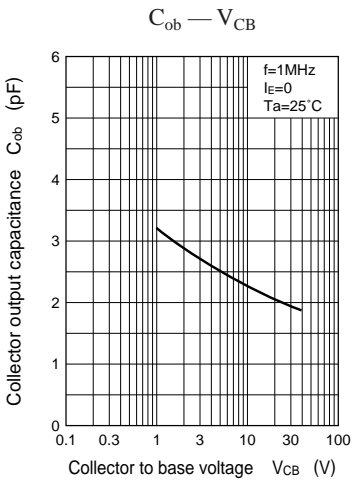
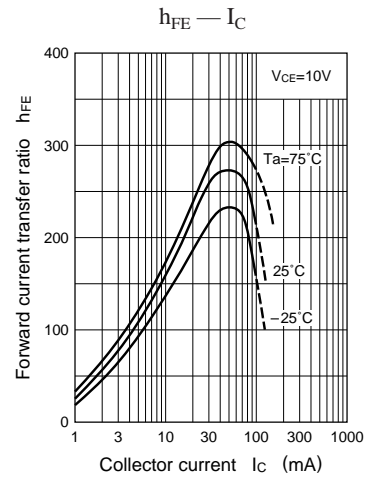
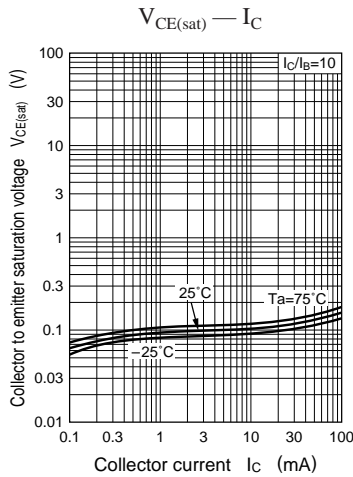
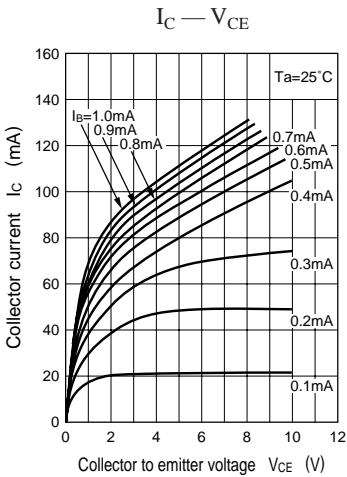

Characteristics charts of UN9213

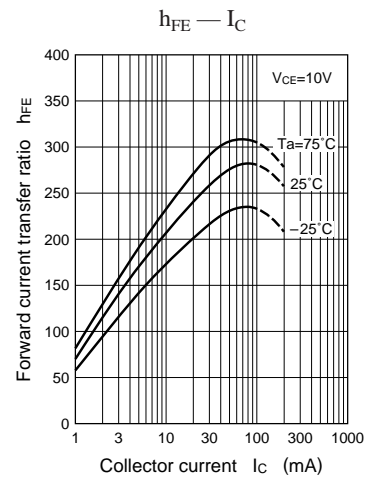
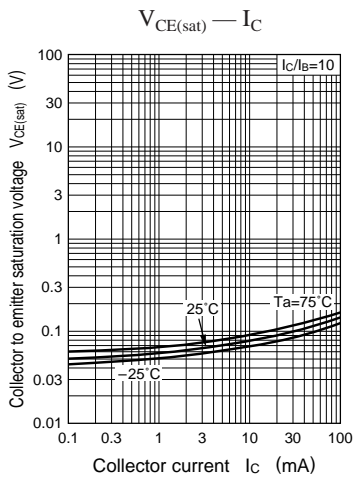
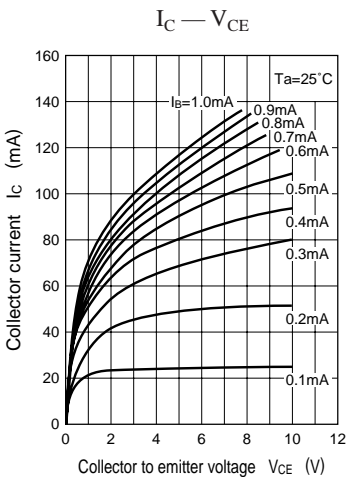

UN1211/1212/1213/1214/1215/1216/1217/1218/  
 Transistors with built-in Resistor 1219/1210/121D/121E/121F/121K/121L

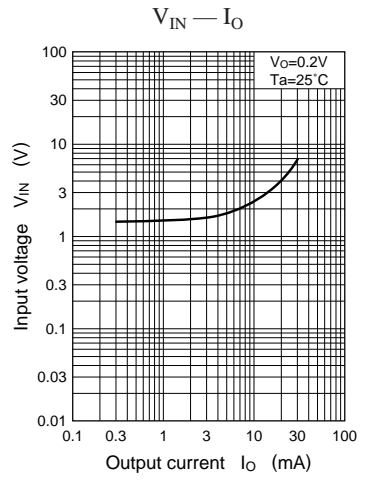
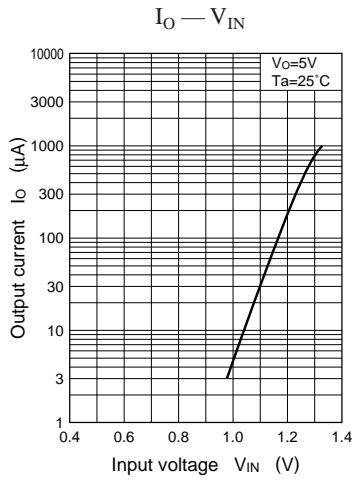
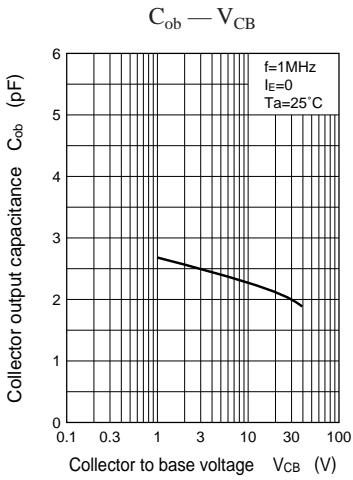

Characteristics charts of UN9214

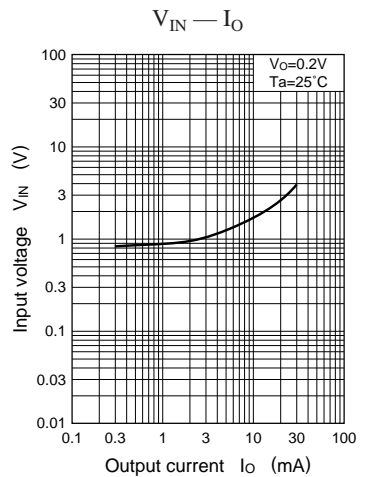
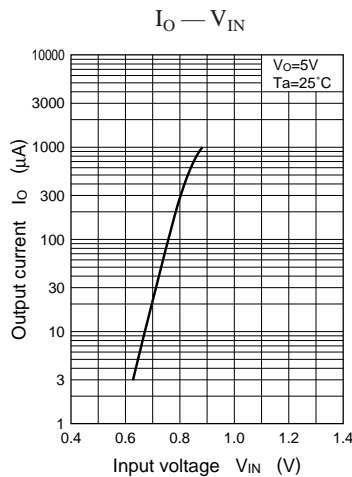
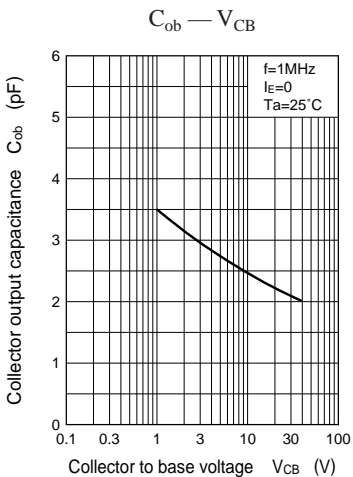
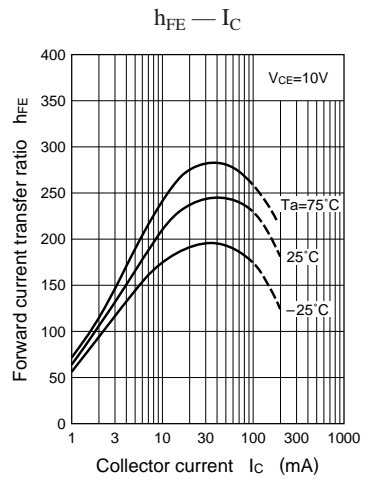
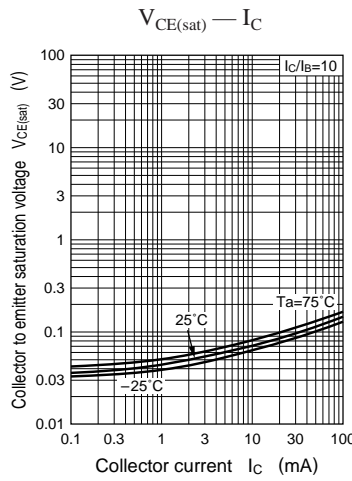
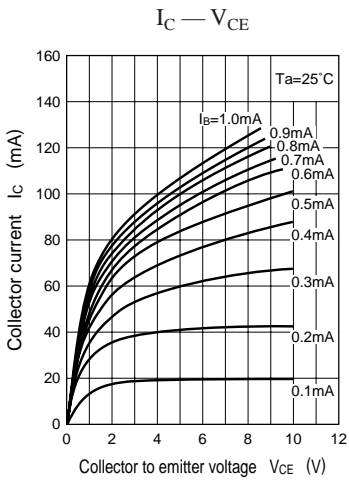

UN9211/9212/9213/9214/9215/9216/9217/9218/9219/9210/921D/  
**Transistors with built-in Resistor 921E/921F/921K/921L/UNR921M/921N/921AJ/921BJ/921CJ**

Characteristics charts of UN9215

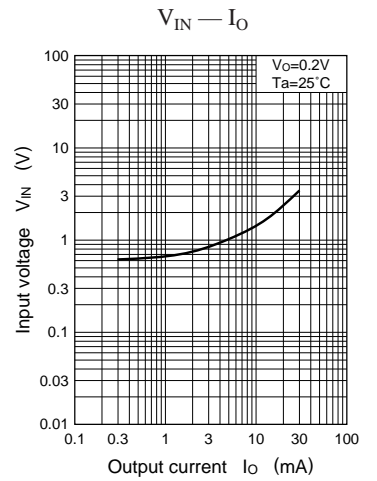
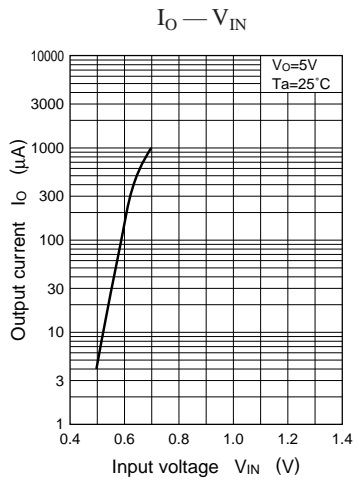
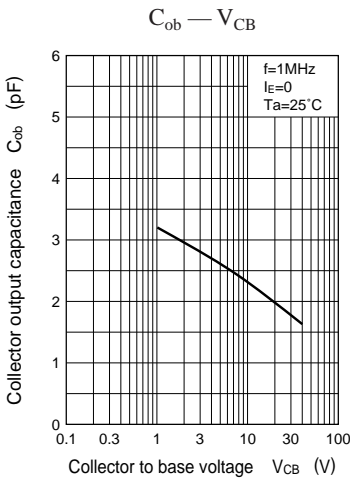
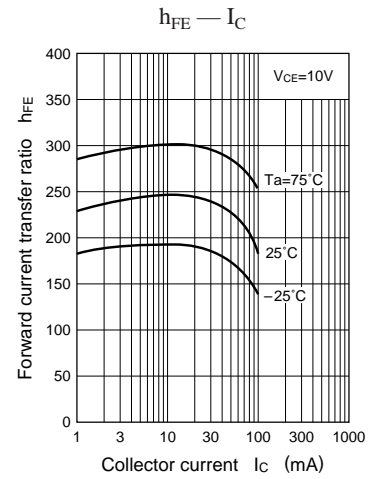
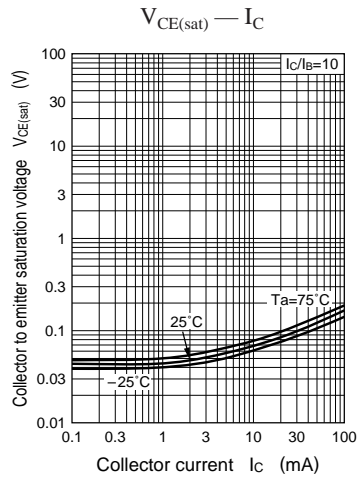
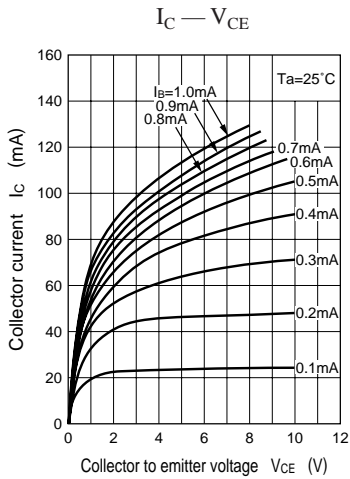

Characteristics charts of UN9216

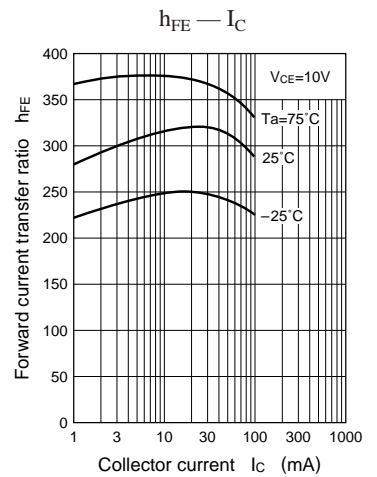
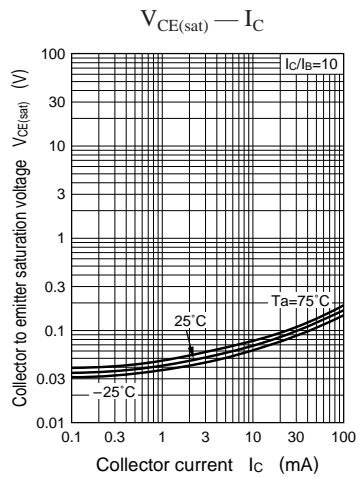
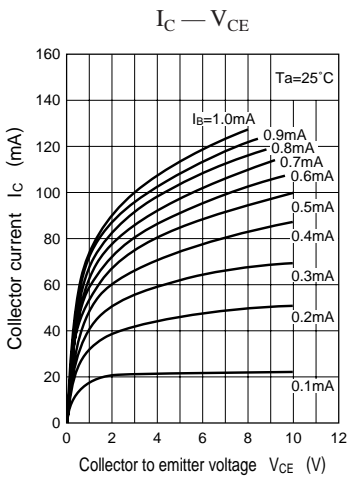

UN9211/9212/9213/9214/9215/9216/9217/9218/9219/9210/921D/  
**Transistors with built-in Resistor 921E/921F/921K/921L/UNR921M/921N/921AJ/921BJ/921CJ**

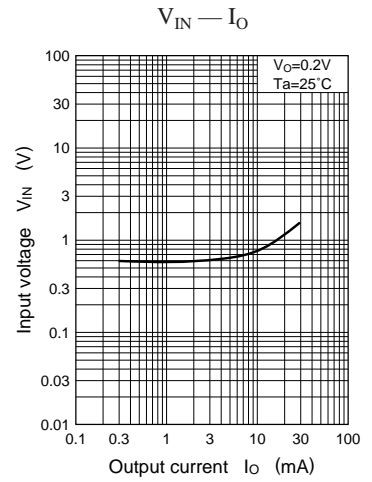
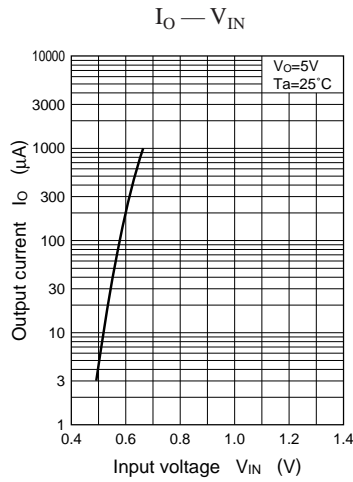
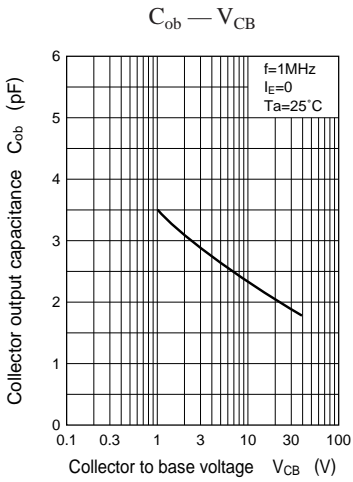

Characteristics charts of UN9217

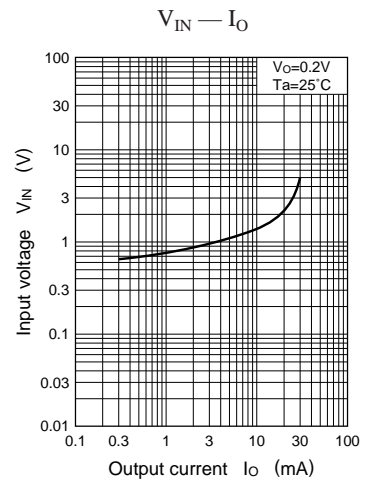
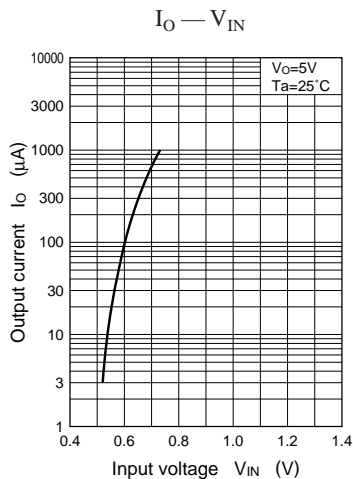
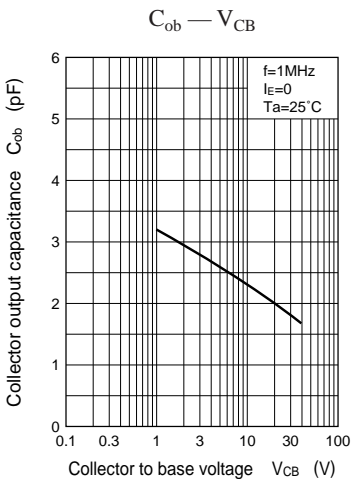
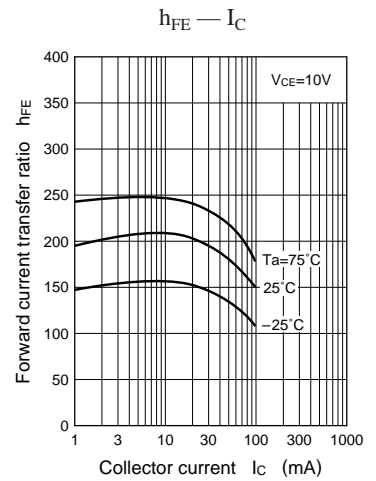
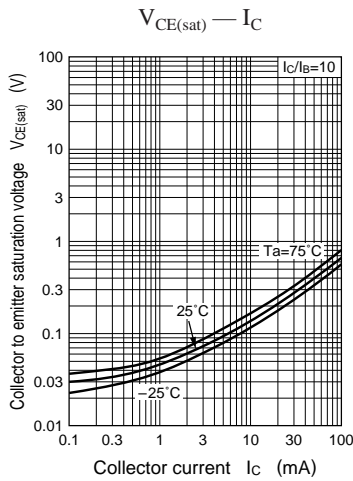
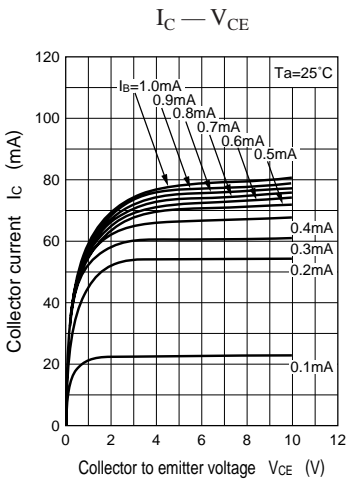



UN9211/9212/9213/9214/9215/9216/9217/9218/9219/9210/921D/  
 Transistors with built-in Resistor 921E/921F/921K/921L/UNR921M/921N/921AJ/921BJ/921CJ

Characteristics charts of UN9218

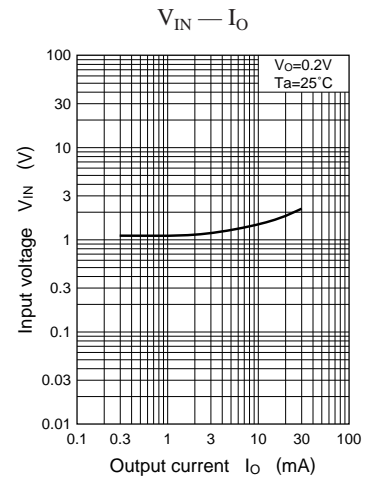
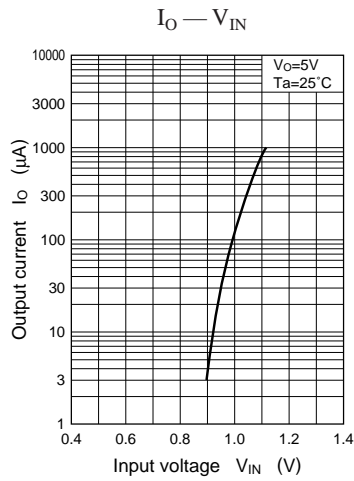
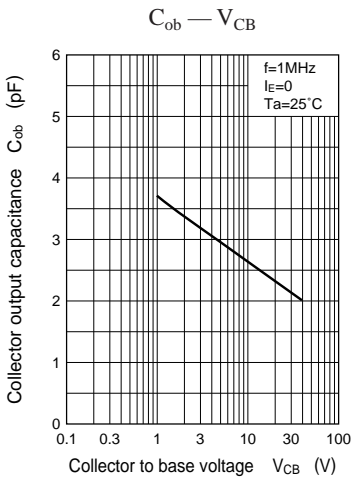
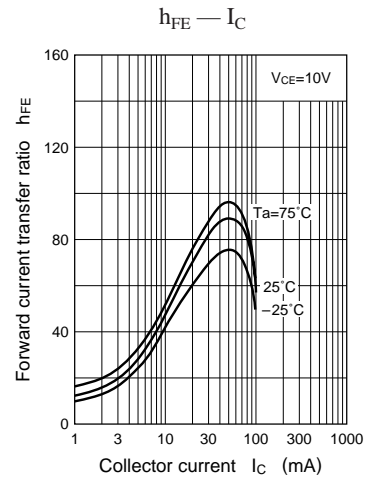
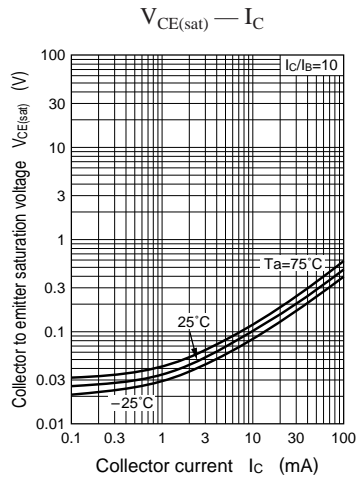
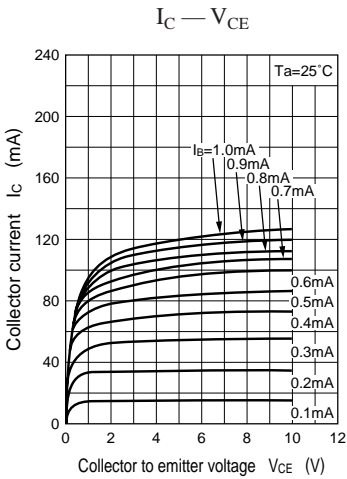

Characteristics charts of UN9219

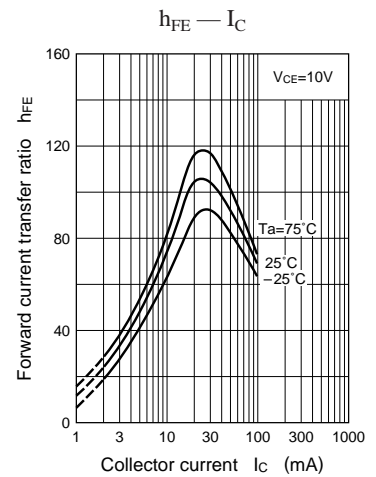
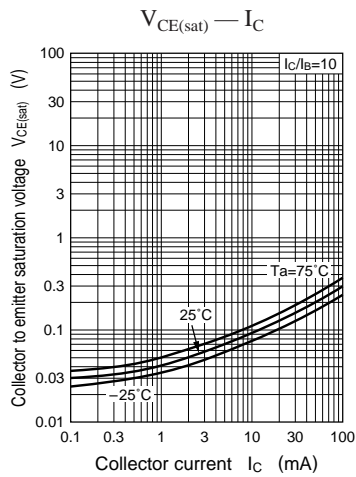
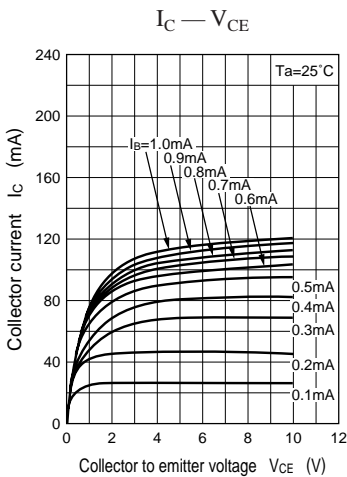

UN9211/9212/9213/9214/9215/9216/9217/9218/9219/9210/921D/  
**Transistors with built-in Resistor 921E/921F/921K/921L/UNR921M/921N/921AJ/921BJ/921CJ**

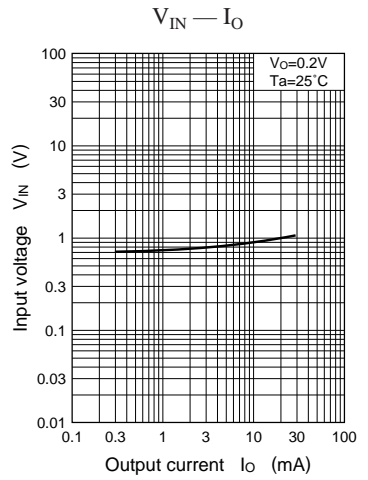
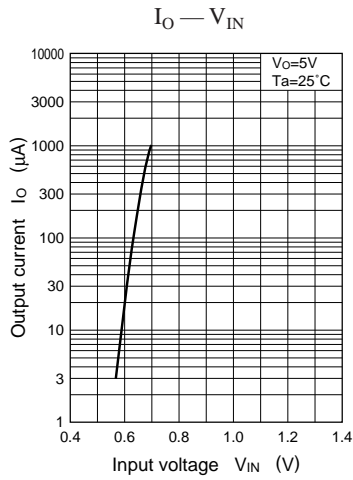
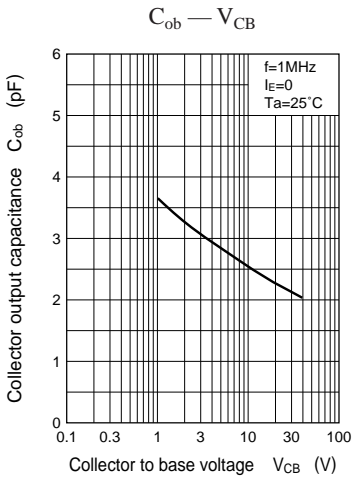

Characteristics charts of UN9210

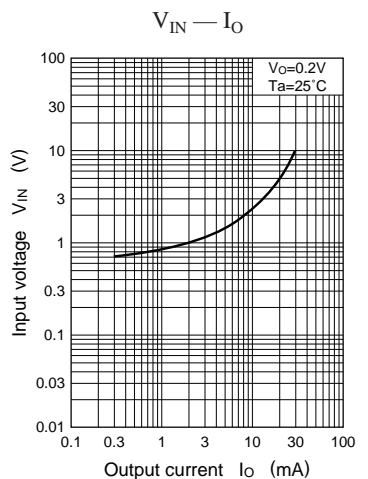
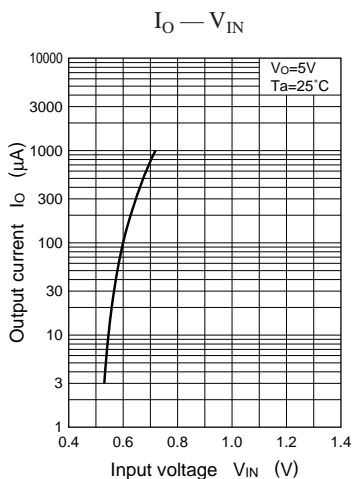
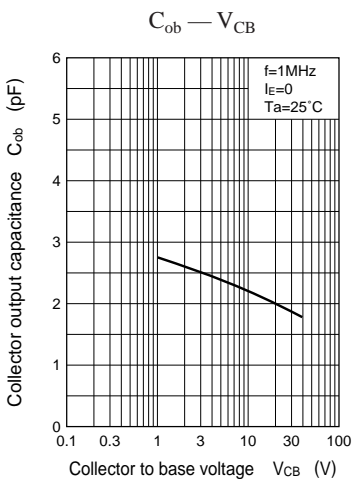
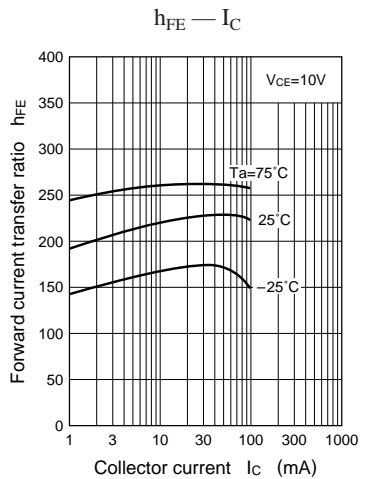
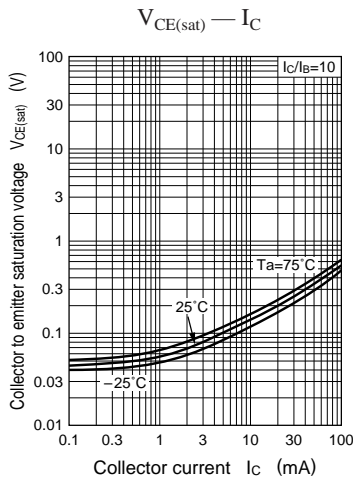
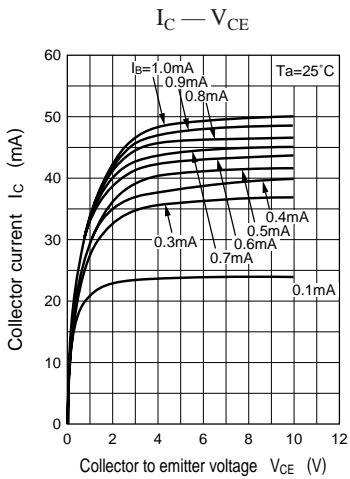

UN9211/9212/9213/9214/9215/9216/9217/9218/9219/9210/921D/  
**Transistors with built-in Resistor** 921E/921F/921K/921L/UNR921M/921N/921AJ/921BJ/921CJ

Characteristics charts of UN921D

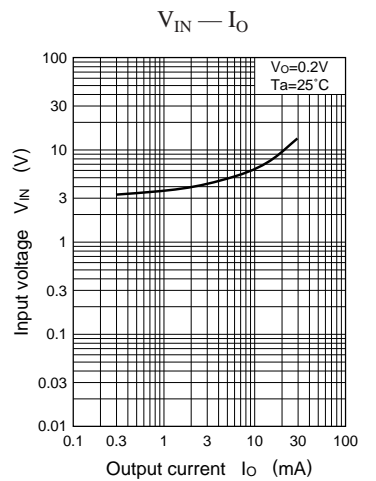
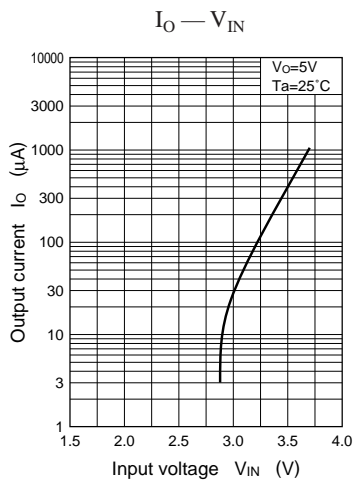
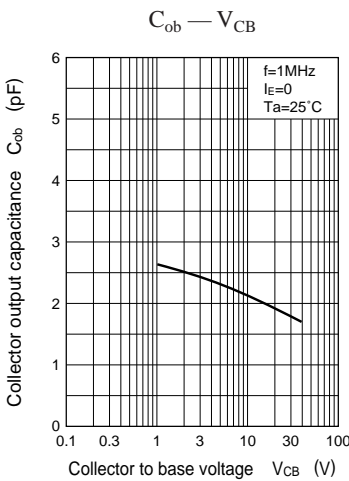
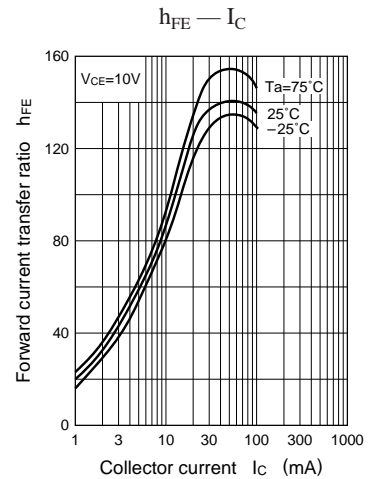
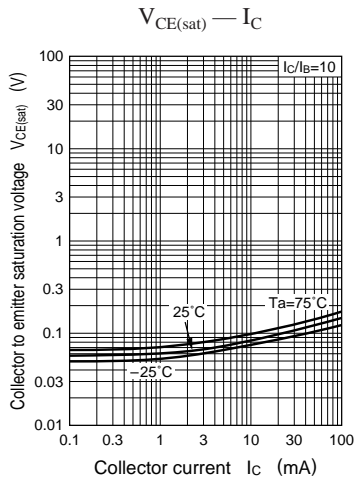
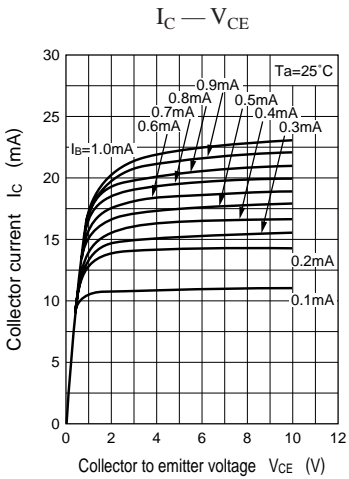

Characteristics charts of UN921E

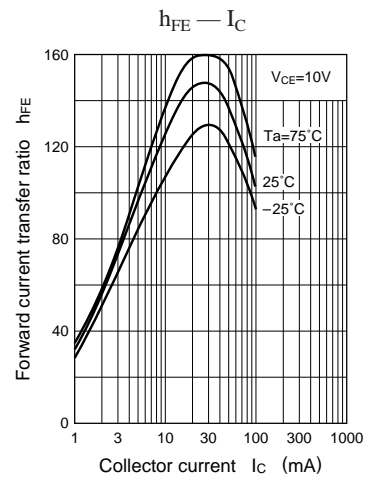
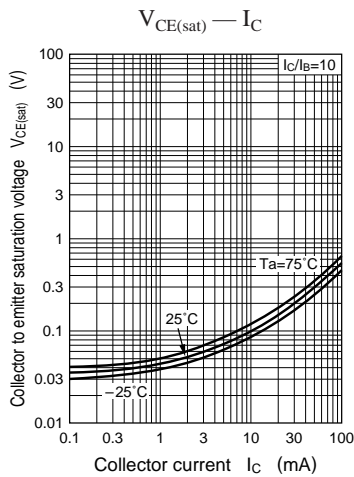
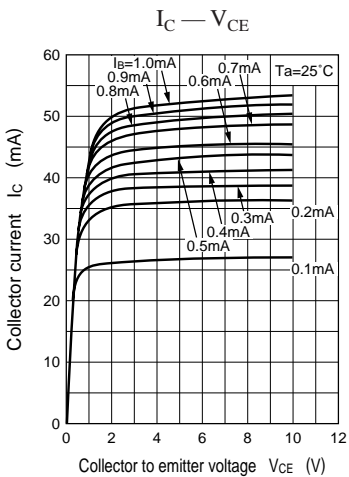

UN9211/9212/9213/9214/9215/9216/9217/9218/9219/9210/921D/  
**Transistors with built-in Resistor 921E/921F/921K/921L/UNR921M/921N/921AJ/921BJ/921CJ**

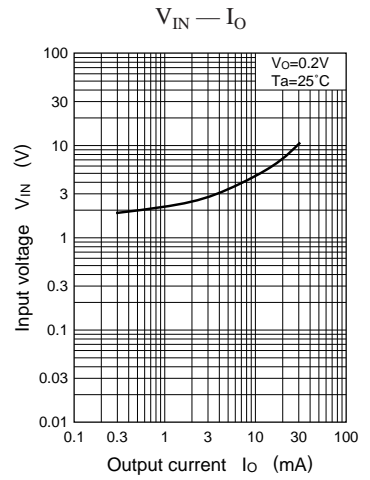
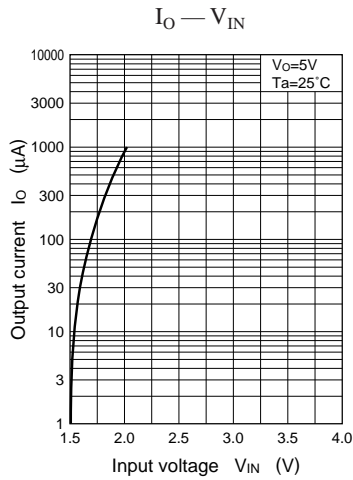
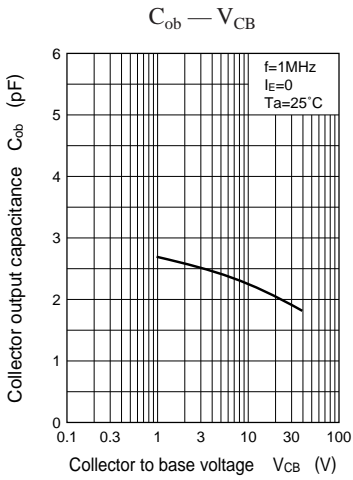

Characteristics charts of UN921F

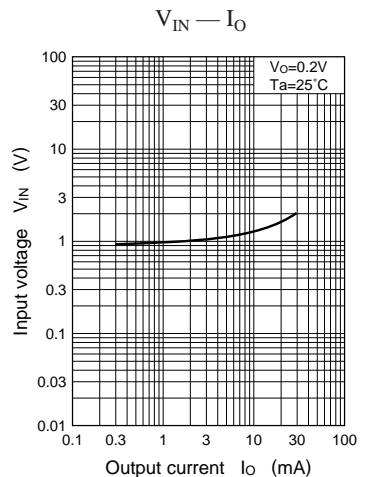
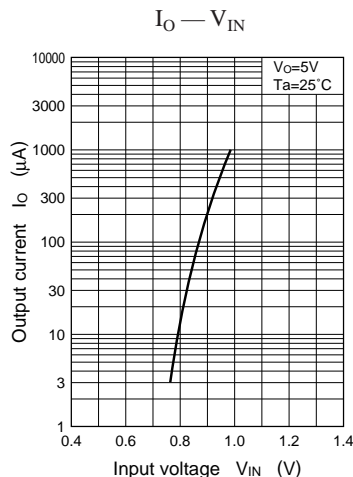
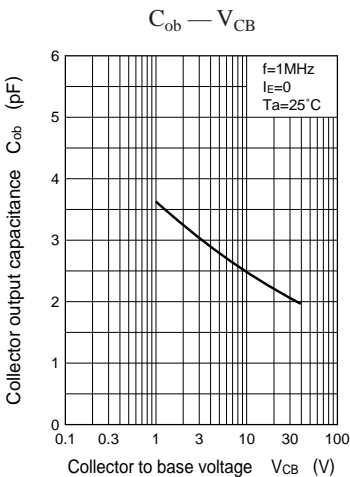
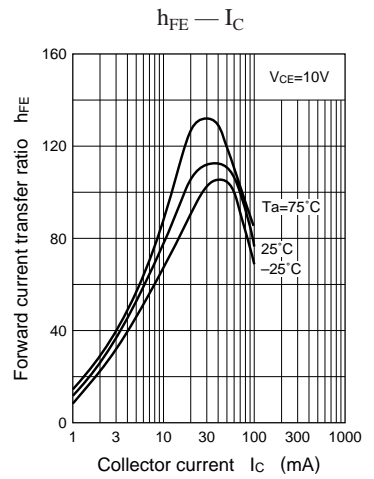
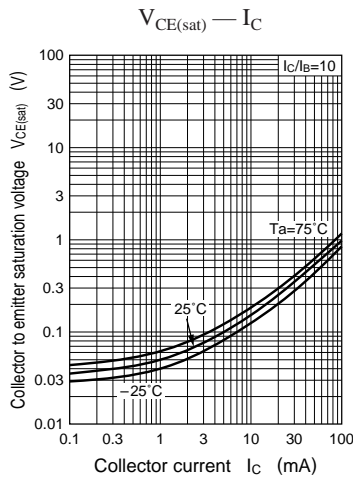
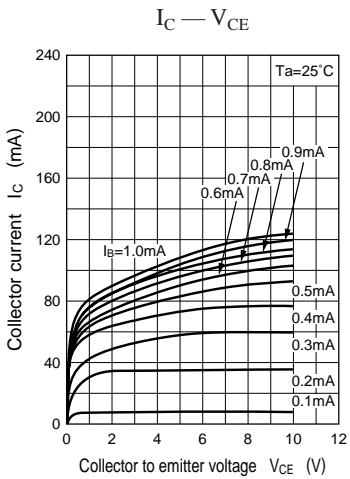

UN9211/9212/9213/9214/9215/9216/9217/9218/9219/9210/921D/  
**Transistors with built-in Resistor 921E/921F/921K/921L/UNR921M/921N/921AJ/921BJ/921CJ**

Characteristics charts of UN921K

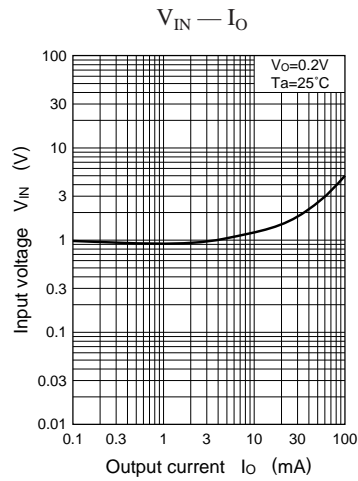
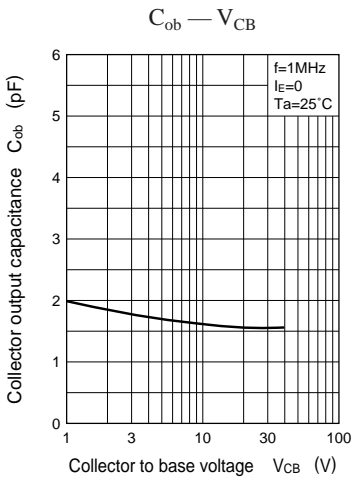
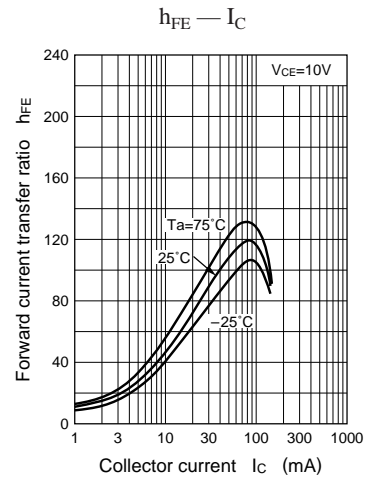
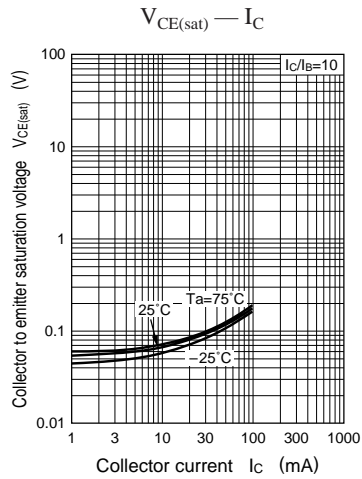
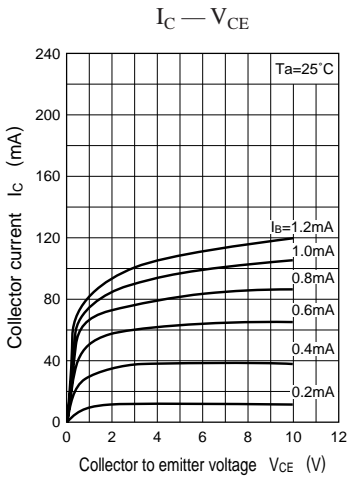

Characteristics charts of UN921L

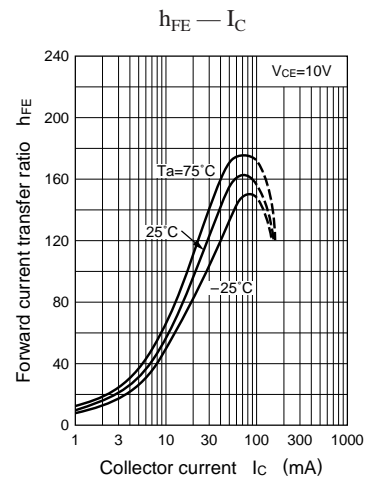
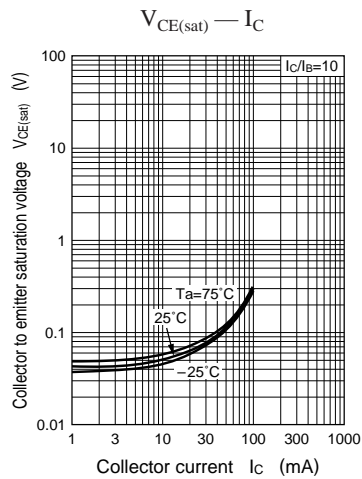
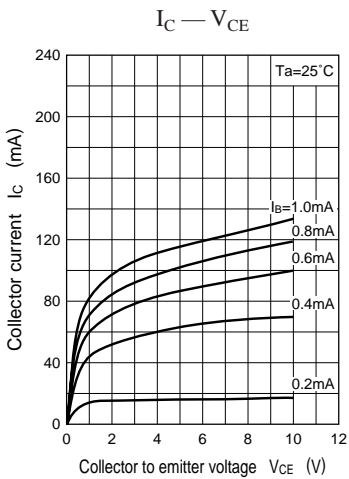

UN9211/9212/9213/9214/9215/9216/9217/9218/9219/9210/921D/  
**Transistors with built-in Resistor 921E/921F/921K/921L/UNR921M/921N/921AJ/921BJ/921CJ**

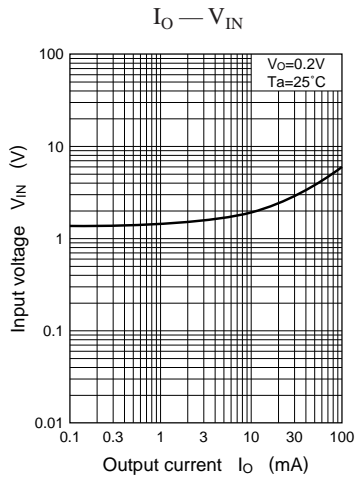
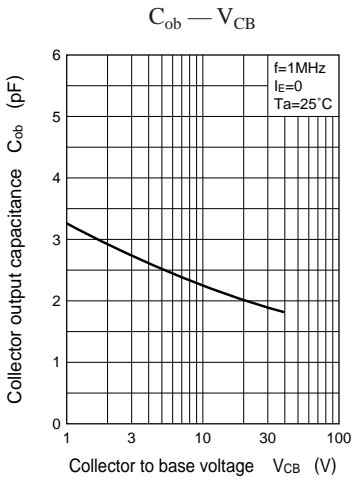

Characteristics charts of UN921M

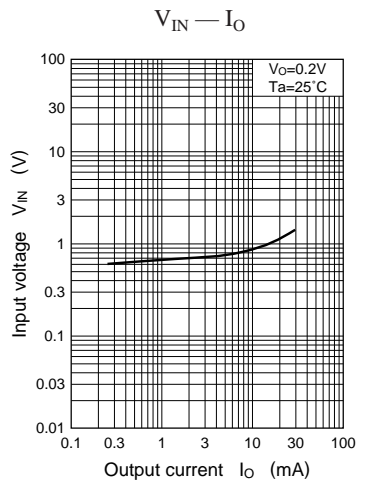
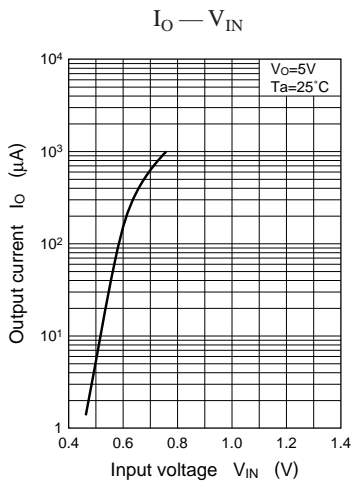
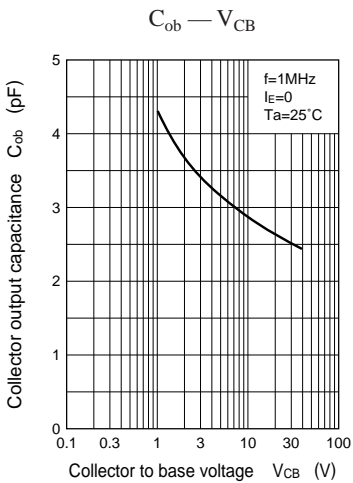
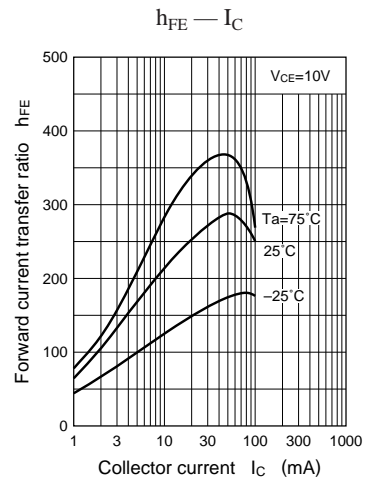
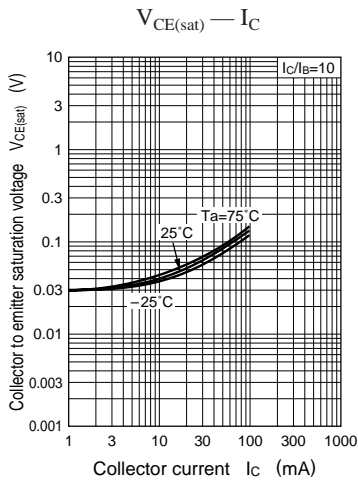
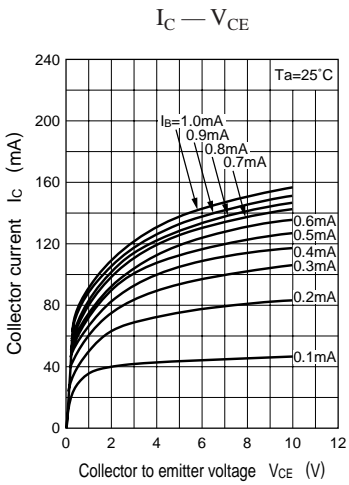

UN9211/9212/9213/9214/9215/9216/9217/9218/9219/9210/921D/  
**Transistors with built-in Resistor 921E/921F/921K/921L/UNR921M/921N/921AJ/921BJ/921CJ**

Characteristics charts of UN921N

