

# BIPOLAR ANALOG INTEGRATED CIRCUIT

# $\mu$ PC2710TB

### 5 V, SUPER MINIMOLD SILICON MMIC MEDIUM OUTPUT POWER AMPLIFIER

#### DESCRIPTION

The  $\mu$ PC2710TB is a silicon monolithic integrated circuit designed as PA driver for 900 MHz band cellular telephone tuners. This IC is packaged in super minimold package which is smaller than conventional minimold.

This IC is manufactured using NEC's 20 GHz fr NESAT™ III silicon bipolar process. This process uses silicon nitride passivation film and gold electrodes. These materials can protect chip surface from external pollution and prevent corrosion/migration. Thus, this IC has excellent performance, uniformity and reliability.

#### FEATURES

- Supply voltage :  $V_{CC} = 4.5$  to  $5.5$  V
- Circuit current :  $I_{CC} = 22$  mA TYP. @  $V_{CC} = 5.0$  V
- Power gain :  $G_P = 33$  dB TYP. @  $f = 500$  MHz
- Medium output power :  $P_{O(sat)} = +13.5$  dBm TYP. @  $f = 500$  MHz
- Upper limit operating frequency :  $f_u = 1.0$  GHz TYP. @ 3 dB bandwidth
- Port impedance : input/output  $50 \Omega$
- High-density surface mounting : 6-pin super minimold package ( $2.0 \times 1.25 \times 0.9$  mm)

#### APPLICATION

- PA driver for 900 MHz band cellular telephone

#### ORDERING INFORMATION

Part Number	Package	Marking	Supplying Form
$\mu$ PC2710TB-E3	6-pin super minimold	C1F	Embossed tape 8 mm wide. 1, 2, 3 pins face the perforation side of the tape. Qty 3 kpcs/reel.

**Remark** To order evaluation samples, please contact your local NEC sales office.  
(Part number for sample order:  $\mu$ PC2710TB)

#### Caution Electro-static sensitive devices

The information in this document is subject to change without notice. Before using this document, please confirm that this is the latest version.  
Not all devices/types available in every country. Please check with local NEC representative for availability and additional information.

**PIN CONNECTIONS**

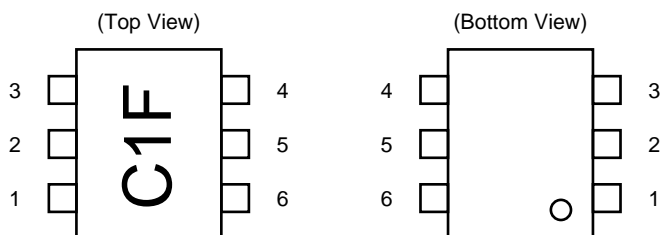

Pin No.	Pin Name
1	INPUT
2	GND
3	GND
4	OUTPUT
5	GND
6	V <sub>CC</sub>

★ **PRODUCT LINE-UP** ( $T_A = +25^\circ\text{C}$ ,  $V_{CC} = V_{out} = 5.0\text{ V}$ ,  $Z_s = Z_L = 50\ \Omega$ )

Part No.	$f_u$ (GHz)	$P_{O(sat)}$ (dBm)	$G_P$ (dB)	NF (dB)	$I_{CC}$ (mA)	Package	Marking
$\mu$ PC2708T	2.9	+10.0	15	6.5	26	6-pin minimold	C1D
$\mu$ PC2708TB						6-pin super minimold	
$\mu$ PC2709T	2.3	+11.5	23	5.0	25	6-pin minimold	C1E
$\mu$ PC2709TB						6-pin super minimold	
$\mu$ PC2710T	1.0	+13.5	33	3.5	22	6-pin minimold	C1F
$\mu$ PC2710TB						6-pin super minimold	
$\mu$ PC2776T	2.7	+8.5	23	6.0	25	6-pin minimold	C2L
$\mu$ PC2776TB						6-pin super minimold	

**Remark** Typical performance. Please refer to **ELECTRICAL CHARACTERISTICS** in detail.

**Notice** The package size distinguishes between minimold and super minimold.

SYSTEM APPLICATION EXAMPLE

EXAMPLE OF 900 MHz BAND DIGITAL CELLULER TELEPHONE

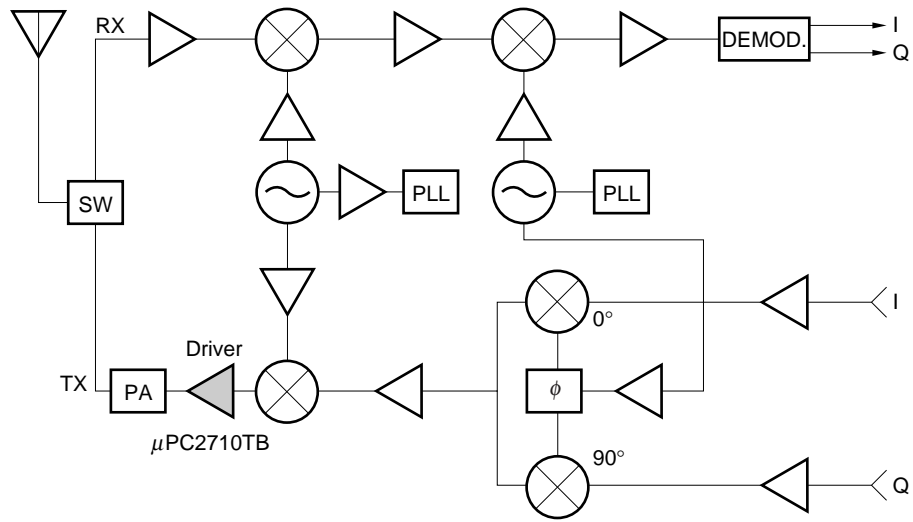

PIN EXPLANATION

Pin No.	Pin Name	Applied Voltage (V)	Pin Voltage (V) <small>Note</small>	Function and Applications	Internal Equivalent Circuit
1	INPUT	–	0.90	Signal input pin. A internal matching circuit, configured with resistors, enables 50 Ω connection over a wide band. A multi-feedback circuit is designed to cancel the deviations of $h_{FE}$ and resistance. This pin must be coupled to signal source with capacitor for DC cut.	
2 3 5	GND	0	–	Ground pin. This pin should be connected to system ground with minimum inductance. Ground pattern on the board should be formed as wide as possible. All the ground pins must be connected together with wide ground pattern to decrease impedance difference.	
4	OUTPUT	Voltage as same as $V_{CC}$ through external inductor	–	Signal output pin. The inductor must be attached between $V_{CC}$ and output pins to supply current to the internal output transistors.	
6	$V_{CC}$	4.5 to 5.5	–	Power supply pin, which biases the internal input transistor. This pin should be externally equipped with bypass capacitor to minimize its impedance.	

**Note** Pin voltage is measured at  $V_{CC} = 5.0\text{ V}$

**ABSOLUTE MAXIMUM RATINGS**

Parameter	Symbol	Conditions	Ratings	Unit
Supply Voltage	V <sub>CC</sub>	T <sub>A</sub> = +25°C, pin 4 and pin 6	5.8	V
Total Circuit Current	I <sub>CC</sub>	T <sub>A</sub> = +25°C	60	mA
Power Dissipation	P <sub>D</sub>	Mounted on double-sided copper clad 50 × 50 × 1.6 mm epoxy glass PWB T <sub>A</sub> = +85°C	270	mW
Operating Ambient Temperature	T <sub>A</sub>		-40 to +85	°C
Storage Temperature	T <sub>stg</sub>		-55 to +150	°C
Input Power	P <sub>in</sub>	T <sub>A</sub> = +25°C	+10	dBm

★

**RECOMMENDED OPERATING RANGE**

Parameter	Symbol	MIN.	TYP.	MAX.	Unit	Remark
Supply Voltage	V <sub>CC</sub>	4.5	5.0	5.5	V	The same voltage should be applied to pin 4 and pin 6.

**ELECTRICAL CHARACTERISTICS**

(Unless otherwise specified, T<sub>A</sub> = +25°C, V<sub>CC</sub> = V<sub>out</sub> = 5.0 V, Z<sub>s</sub> = Z<sub>L</sub> = 50 Ω)

Parameter	Symbol	Test Conditions	MIN.	TYP.	MAX.	Unit
Circuit Current	I <sub>CC</sub>	No signal	16	22	29	mA
Power Gain	G <sub>P</sub>	f = 500 MHz	30	33	36.5	dB
Saturated Output Power	P <sub>O(sat)</sub>	f = 500 MHz, P <sub>in</sub> = -8 dBm	+11.0	+13.5	-	dBm
Noise Figure	NF	f = 500 MHz	-	3.5	5.0	dB
Upper Limit Operating Frequency	f <sub>u</sub>	3 dB down below flat gain at f = 0.1 GHz	0.7	1.0	-	GHz
Isolation	ISL	f = 500 MHz	34	39	-	dB
Input Return Loss	RL <sub>in</sub>	f = 500 MHz	3	6	-	dB
Output Return Loss	RL <sub>out</sub>	f = 500 MHz	9	12	-	dB
Gain Flatness	ΔG <sub>P</sub>	f = 0.1 to 0.6 GHz	-	±0.8	-	dB

**TEST CIRCUIT**

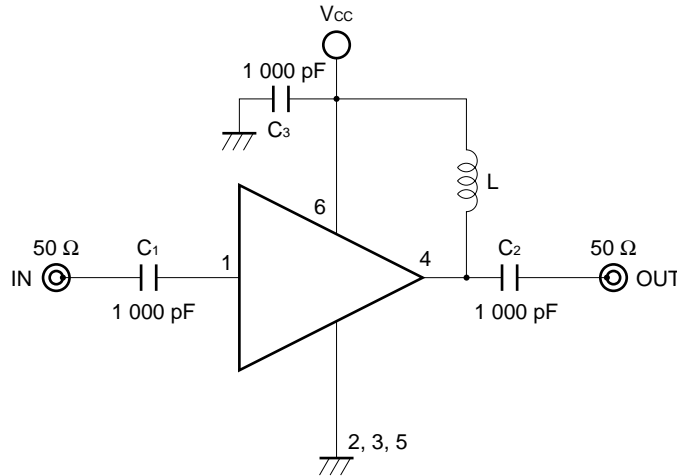

**COMPONENTS OF TEST CIRCUIT FOR MEASURING ELECTRICAL CHARACTERISTICS**

	Type	Value
C <sub>1</sub> , C <sub>2</sub>	Bias Tee	1 000 pF
C <sub>3</sub>	Capacitor	1 000 pF
L	Bias Tee	1 000 nH

**EXAMPLE OF ACTUAL APPLICATION COMPONENTS**

	Type	Value	Operating Frequency
C <sub>1</sub> to C <sub>3</sub>	Chip Capacitor	1 000 pF	100 MHz or higher
L	Chip Inductor	300 nH	10 MHz or higher
		100 nH	100 MHz or higher
		10 nH	1.0 GHz or higher

**INDUCTOR FOR THE OUTPUT PIN**

The internal output transistor of this IC consumes 20 mA, to output medium power. To supply current for output transistor, connect an inductor between the Vcc pin (pin 6) and output pin (pin 4). Select large value inductance, as listed above.

The inductor has both DC and AC effects. In terms of DC, the inductor biases the output transistor with minimum voltage drop to output enable high level. In terms of AC, the inductor make output-port impedance higher to get enough gain. In this case, large inductance and Q is suitable.

**CAPACITORS FOR THE Vcc, INPUT AND OUTPUT PINS**

Capacitors of 1000 pF are recommendable as the bypass capacitor for the Vcc pin and the coupling capacitors for the input and output pins.

The bypass capacitor connected to the Vcc pin is used to minimize ground impedance of Vcc pin. So, stable bias can be supplied against Vcc fluctuation.

The coupling capacitors, connected to the input and output pins, are used to cut the DC and minimize RF serial impedance. Their capacitance are therefore selected as lower impedance against a 50 Ω load. The capacitors thus perform as high pass filters, suppressing low frequencies to DC.

To obtain a flat gain from 100 MHz upwards, 1000 pF capacitors are used in the test circuit. In the case of under 10 MHz operation, increase the value of coupling capacitor such as 10000 pF. Because the coupling capacitors are determined by equation,  $C = 1/(2 \pi Rf_c)$ .

ILLUSTRATION OF THE TEST CIRCUIT ASSEMBLED ON EVALUATION BOARD

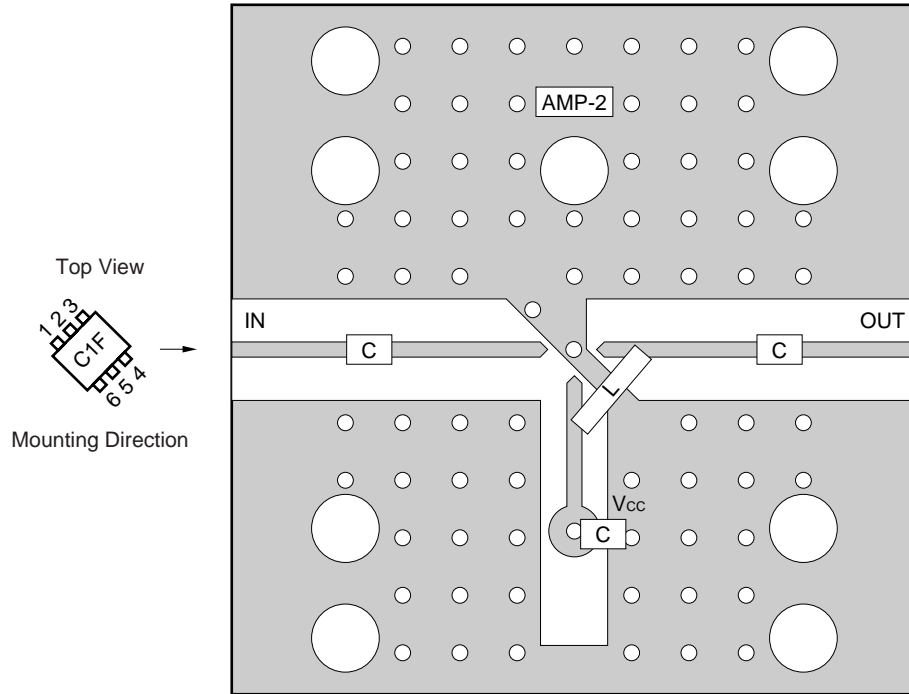

COMPONENT LIST

	Value
C	1 000 pF
L	300 nH

Notes

1. 30 × 30 × 0.4 mm double sided copper clad polyimide board.
2. Back side: GND pattern
3. Solder plated on pattern
4. ○ ○ : Through holes

For more information on the use of this IC, refer to the following application note: **USAGE AND APPLICATION OF 6-PIN SUPER MINIMOLD SILICON MEDIUM-POWER HIGH-FREQUENCY AMPLIFIER MMIC (P13252E).**

**TYPICAL CHARACTERISTICS (Unless otherwise specified,  $T_A = +25^\circ\text{C}$ )**

**CIRCUIT CURRENT vs. SUPPLY VOLTAGE**

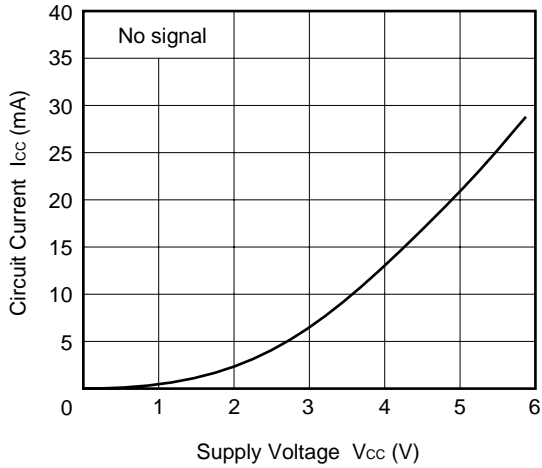

**CIRCUIT CURRENT vs. OPERATING AMBIENT TEMPERATURE**

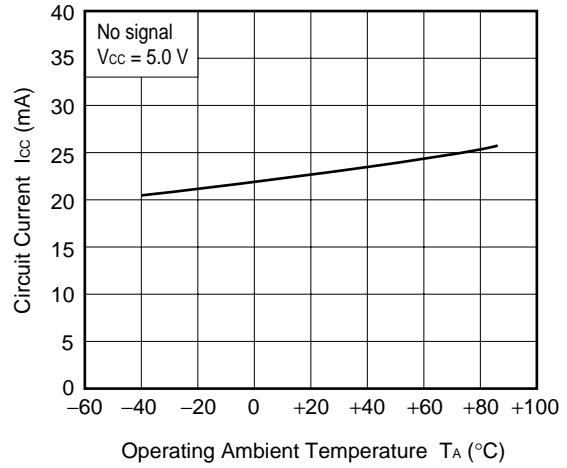

**NOISE FIGURE, POWER GAIN vs. FREQUENCY**

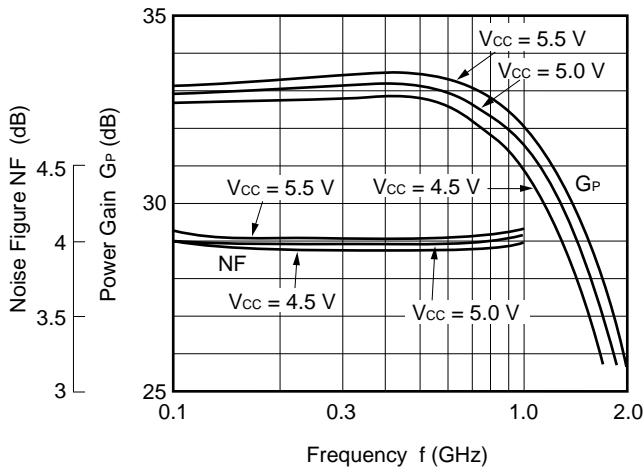

**POWER GAIN vs. FREQUENCY**

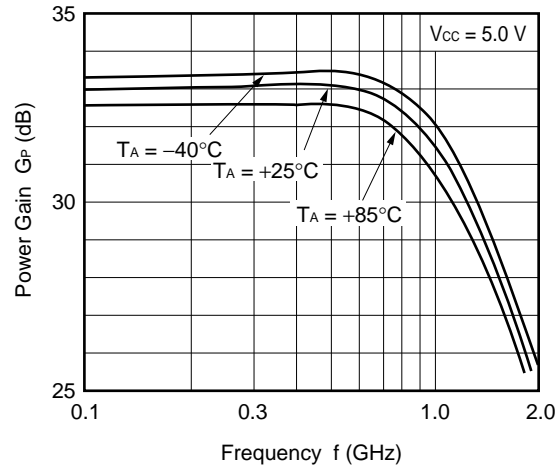

**ISOLATION vs. FREQUENCY**

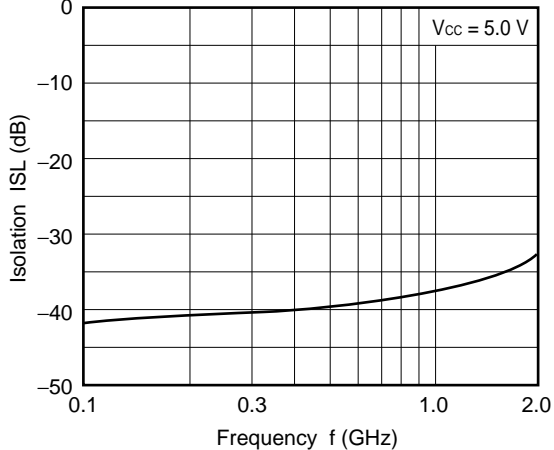

**INPUT RETURN LOSS, OUTPUT RETURN LOSS vs. FREQUENCY**

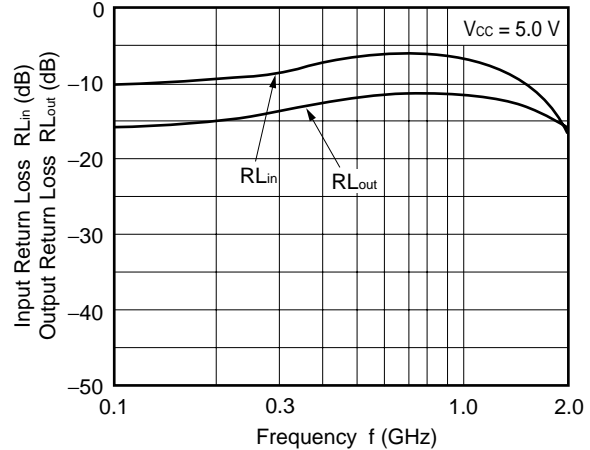



OUTPUT POWER vs. INPUT POWER

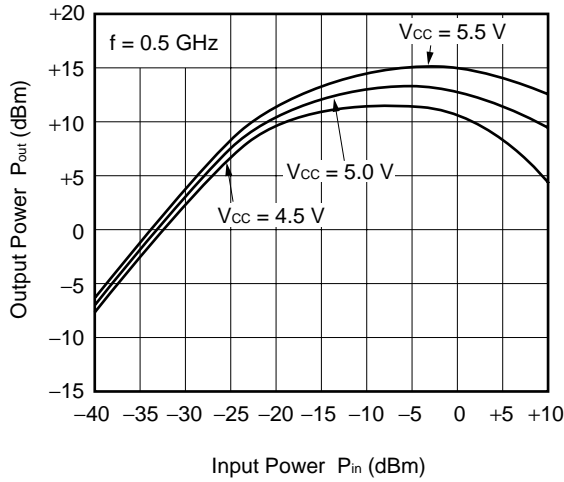

OUTPUT POWER vs. INPUT POWER

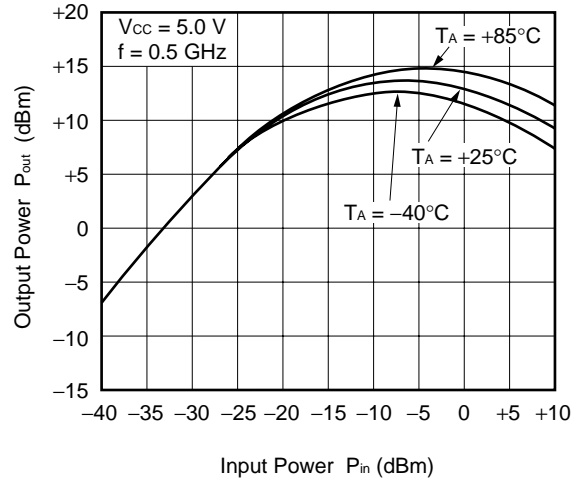

OUTPUT POWER vs. INPUT POWER

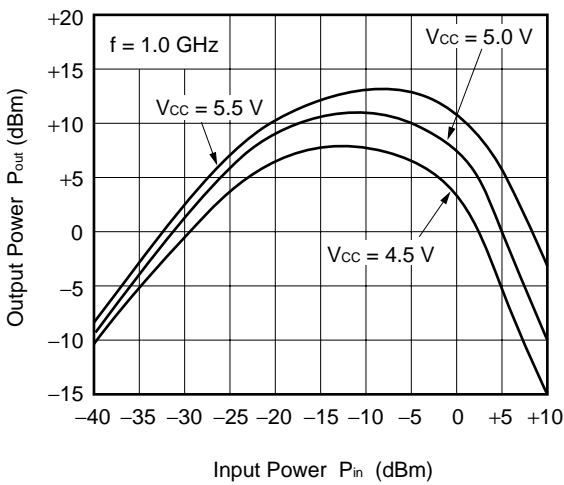

OUTPUT POWER vs. INPUT POWER

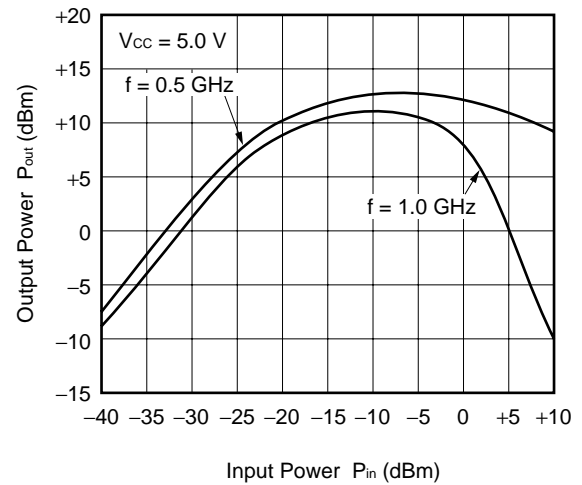

SATURATED OUTPUT POWER vs. FREQUENCY

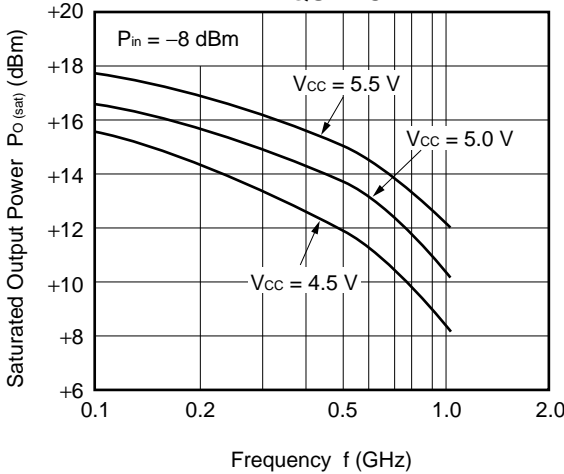

3RD ORDER INTERMODULATION DISTORTION vs. OUTPUT POWER OF EACH TONE

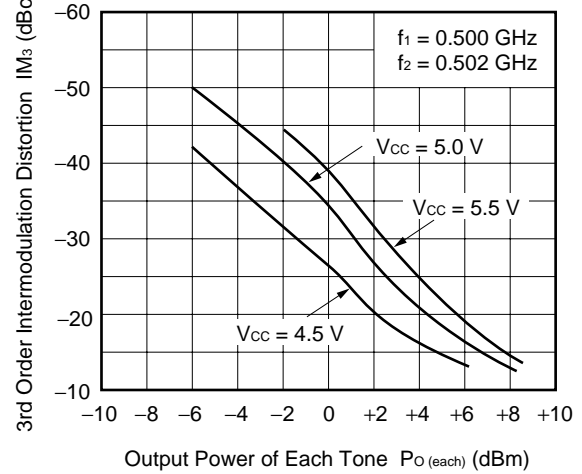

S-PARAMETERS (T<sub>A</sub> = +25°C, V<sub>CC</sub> = V<sub>out</sub> = 5.0 V)

S<sub>11</sub>-FREQUENCY

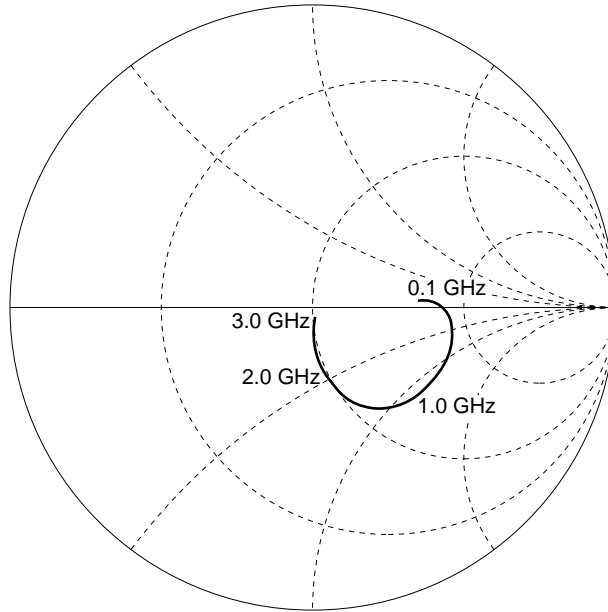

S<sub>22</sub>- FREQUENCY

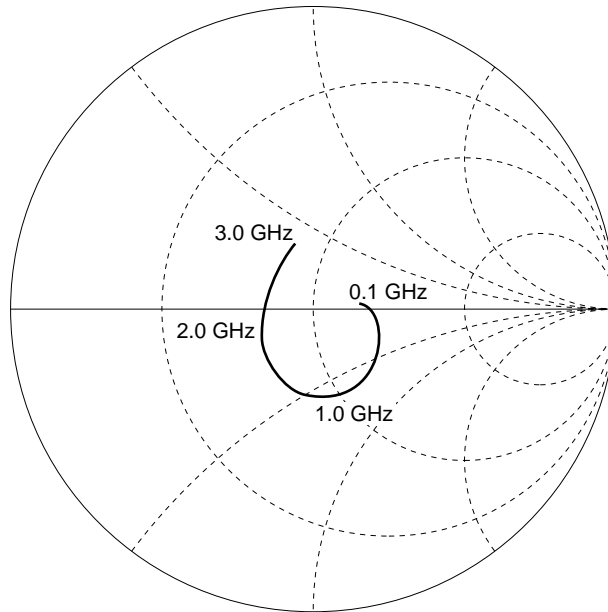

**TYPICAL S-PARAMETER VALUES (T<sub>A</sub> = +25°C)**

V<sub>CC</sub> = V<sub>out</sub> = 5.0 V, I<sub>CC</sub> = 22 mA

FREQUENCY MHz	S <sub>11</sub>		S <sub>21</sub>		S <sub>12</sub>		S <sub>22</sub>		K
	MAG.	ANG.	MAG.	ANG.	MAG.	ANG.	MAG.	ANG.	
100.0000	0.306	2.5	43.072	-8.4	0.012	15.2	0.156	2.7	1.08
200.0000	0.324	5.2	43.517	-17.1	0.010	10.7	0.164	2.1	1.17
300.0000	0.356	5.3	44.432	-26.5	0.010	20.2	0.185	0.3	1.10
400.0000	0.400	2.5	45.513	-36.9	0.012	26.9	0.225	-5.5	0.92
500.0000	0.439	-3.3	45.679	-48.1	0.012	27.0	0.255	-15.4	0.85
600.0000	0.469	-10.2	45.670	-59.7	0.013	31.3	0.283	-27.6	0.77
700.0000	0.481	-17.9	44.793	-71.8	0.014	34.9	0.301	-40.2	0.74
800.0000	0.488	-26.7	43.016	-84.3	0.014	27.9	0.312	-54.9	0.74
900.0000	0.479	-34.5	40.519	-96.0	0.013	26.6	0.316	-67.7	0.78
1000.0000	0.465	-41.2	37.946	-107.3	0.016	30.8	0.311	-79.5	0.79
1100.0000	0.448	-49.3	35.122	-117.9	0.016	26.6	0.307	-92.2	0.85
1200.0000	0.417	-54.9	32.108	-128.0	0.015	39.5	0.282	-104.6	0.99
1300.0000	0.387	-61.2	29.221	-137.0	0.015	39.7	0.270	-115.5	1.12
1400.0000	0.350	-65.2	26.656	-145.8	0.015	50.2	0.248	-127.0	1.27
1500.0000	0.316	-70.8	23.895	-153.9	0.013	50.8	0.236	-136.2	1.56
1600.0000	0.292	-74.0	21.576	-161.6	0.016	56.6	0.215	-145.3	1.49
1700.0000	0.256	-76.9	19.567	-168.1	0.015	69.0	0.200	-155.2	1.71
1800.0000	0.245	-80.5	17.743	-174.4	0.018	61.7	0.196	-162.5	1.59
1900.0000	0.215	-82.9	16.040	179.6	0.017	70.0	0.180	-173.4	1.88
2000.0000	0.201	-85.6	14.717	173.5	0.021	71.2	0.175	-178.1	1.71
2100.0000	0.177	-84.4	13.475	168.8	0.020	83.0	0.166	172.0	1.94
2200.0000	0.161	-88.8	12.327	163.1	0.021	76.7	0.171	167.7	1.99
2300.0000	0.145	-88.7	11.154	158.7	0.022	87.9	0.159	159.1	2.08
2400.0000	0.124	-90.3	10.262	154.4	0.023	81.4	0.164	154.0	2.15
2500.0000	0.113	-89.8	9.490	150.4	0.025	91.9	0.158	147.0	2.19
2600.0000	0.107	-91.9	8.793	146.4	0.028	88.7	0.166	141.8	2.06
2700.0000	0.091	-92.2	8.149	142.4	0.030	93.4	0.175	135.7	2.13
2800.0000	0.081	-94.9	7.652	138.9	0.031	92.1	0.183	131.6	2.13
2900.0000	0.067	-97.4	7.134	135.1	0.031	93.0	0.191	123.4	2.26
3000.0000	0.055	-103.8	6.726	131.5	0.039	88.3	0.200	118.9	1.97
3100.0000	0.039	-95.6	6.295	128.4	0.039	89.6	0.203	111.5	2.08

★ PACKAGE DIMENSIONS

6-PIN SUPER MINIMOLD (UNIT: mm)

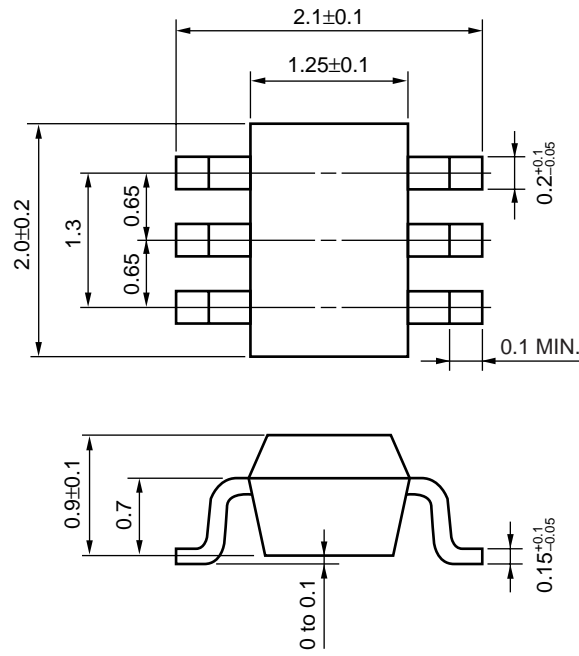

**NOTES ON CORRECT USE**

- (1) Observe precautions for handling because of electro-static sensitive devices.
- (2) Form a ground pattern as widely as possible to minimize ground impedance (to prevent undesired oscillation).  
All the ground pins must be connected together with wide ground pattern to decrease impedance difference.
- (3) The bypass capacitor should be attached to Vcc line.
- (4) The inductor must be attached between Vcc and output pins. The inductance value should be determined in accordance with desired frequency.
- (5) The DC cut capacitor must be attached to input pin and output pin.

**RECOMMENDED SOLDERING CONDITIONS**

This product should be soldered under the following recommended conditions. For soldering methods and conditions other than those recommended below, contact your NEC sales representative.

Soldering Method	Soldering Conditions	Recommended Condition Symbol
Infrared Reflow	Package peak temperature: 235°C or below Time: 30 seconds or less (at 210°C) Count: 3, Exposure limit: None <sup>Note</sup>	IR35-00-3
VPS	Package peak temperature: 215°C or below Time: 40 seconds or less (at 200°C) Count: 3, Exposure limit: None <sup>Note</sup>	VP15-00-3
Wave Soldering	Soldering bath temperature: 260°C or below Time: 10 seconds or less Count: 1, Exposure limit: None <sup>Note</sup>	WS60-00-1
Partial Heating	Pin temperature: 300°C or below Time: 3 seconds or less (per side of device) Exposure limit: None <sup>Note</sup>	—

**Note** After opening the dry pack, keep it in a place below 25°C and 65% RH for the allowable storage period.

**Caution** Do not use different soldering methods together (except for partial heating).

For details of recommended soldering conditions for surface mounting, refer to information document SEMICONDUCTOR DEVICE MOUNTING TECHNOLOGY MANUAL (C10535E).

[MEMO]

[MEMO]

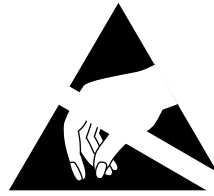

## ATTENTION

OBSERVE PRECAUTIONS  
FOR HANDLING  
ELECTROSTATIC  
SENSITIVE  
DEVICES

**NESAT (NEC Silicon Advanced Technology) is a trademark of NEC Corporation.**

- **The information in this document is current as of January, 2001. The information is subject to change without notice. For actual design-in, refer to the latest publications of NEC's data sheets or data books, etc., for the most up-to-date specifications of NEC semiconductor products. Not all products and/or types are available in every country. Please check with an NEC sales representative for availability and additional information.**
- No part of this document may be copied or reproduced in any form or by any means without prior written consent of NEC. NEC assumes no responsibility for any errors that may appear in this document.
- NEC does not assume any liability for infringement of patents, copyrights or other intellectual property rights of third parties by or arising from the use of NEC semiconductor products listed in this document or any other liability arising from the use of such products. No license, express, implied or otherwise, is granted under any patents, copyrights or other intellectual property rights of NEC or others.
- Descriptions of circuits, software and other related information in this document are provided for illustrative purposes in semiconductor product operation and application examples. The incorporation of these circuits, software and information in the design of customer's equipment shall be done under the full responsibility of customer. NEC assumes no responsibility for any losses incurred by customers or third parties arising from the use of these circuits, software and information.
- While NEC endeavours to enhance the quality, reliability and safety of NEC semiconductor products, customers agree and acknowledge that the possibility of defects thereof cannot be eliminated entirely. To minimize risks of damage to property or injury (including death) to persons arising from defects in NEC semiconductor products, customers must incorporate sufficient safety measures in their design, such as redundancy, fire-containment, and anti-failure features.
- NEC semiconductor products are classified into the following three quality grades:  
 "Standard", "Special" and "Specific". The "Specific" quality grade applies only to semiconductor products developed based on a customer-designated "quality assurance program" for a specific application. The recommended applications of a semiconductor product depend on its quality grade, as indicated below. Customers must check the quality grade of each semiconductor product before using it in a particular application.
  - "Standard": Computers, office equipment, communications equipment, test and measurement equipment, audio and visual equipment, home electronic appliances, machine tools, personal electronic equipment and industrial robots
  - "Special": Transportation equipment (automobiles, trains, ships, etc.), traffic control systems, anti-disaster systems, anti-crime systems, safety equipment and medical equipment (not specifically designed for life support)
  - "Specific": Aircraft, aerospace equipment, submersible repeaters, nuclear reactor control systems, life support systems and medical equipment for life support, etc.

The quality grade of NEC semiconductor products is "Standard" unless otherwise expressly specified in NEC's data sheets or data books, etc. If customers wish to use NEC semiconductor products in applications not intended by NEC, they must contact an NEC sales representative in advance to determine NEC's willingness to support a given application.

(Note)

- (1) "NEC" as used in this statement means NEC Corporation and also includes its majority-owned subsidiaries.
- (2) "NEC semiconductor products" means any semiconductor product developed or manufactured by or for NEC (as defined above).