



# 3 V, SUPER MINIMOLD 1900 MHz SI RFIC AMPLIFIER

## UPC2749TB

### FEATURES

- **HIGH DENSITY SURFACE MOUNTING:**  
6 pin super minimold or SOT-363 package
- **GAIN:** 16 dB TYP
- **NOISE FIGURE:** 4.0 dB TYP
- **SUPPLY VOLTAGE:**  $V_{CC} = 2.7$  to  $3.3$  V

### DESCRIPTION

NEC's UPC2749TB is a Silicon RF Integrated Circuit which is manufactured using the NESAT III process. This device is suitable as a buffer amplifier for GPS, PCS and other communication receivers. The UPC2749TB is pin compatible and has comparable performance as the larger UPC2749T, so it is suitable for use as a replacement to help reduce system size. The IC is housed in a 6 pin super minimold or SOT-363 package.

NEC's stringent quality assurance and test procedures assure the highest reliability and performance.

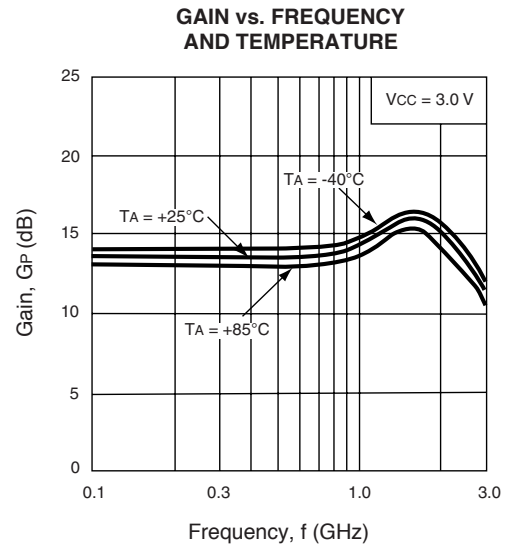

### ELECTRICAL CHARACTERISTICS ( $T_A = 25^\circ\text{C}$ , $Z_L = Z_S = 50 \Omega$ , $V_{CC} = 3.0$ V)

PART NUMBER PACKAGE OUTLINE			UPC2749TB SO6		
SYMBOLS	PARAMETERS AND CONDITIONS	UNITS	MIN	TYP	MAX
$I_{CC}$	Circuit Current (no signal)	mA	4	6	8
$G_S$	Small Signal Gain, $f = 900$ MHz $f = 1900$ MHz	dB dB	13	14.5 16	18.5
$f_{U1}$	Upper Limit Operating Frequency	GHz	2.5	2.9	
$P_{1dB}$	1 dB Compressed Output Power at 1900 MHz	dBm		-12.5	
$P_{SAT}$	Saturated Output Power, $f = 1900$ MHz	dBm	-9	-6	
NF	Noise Figure, $f = 900$ MHz $f = 1900$ MHz	dB dB		3.2 4.0	5.5
$RL_{IN}$	Input Return Loss, $f = 1900$ MHz	dB	7	10	
$RL_{OUT}$	Output Return Loss, $f = 1900$ MHz	dB	9.5	12.5	
ISOL	Isolation, $f = 1900$ MHz	dB	25	30	
OIP <sub>3</sub>	SSB Output Third Order Intercept, $f_1 = 1900$ MHz, $f_2 = 1902$ MHz	dBm		-3.5	
$R_{TH}$ (J-A)	Thermal Resistance (Junction to Ambient) Mounted on a $50 \times 50 \times 1.6$ mm epoxy glass PWB	$^\circ\text{C}/\text{W}$			325

Note:

1. The gain at  $f_{U1}$  is 3 dB down from the gain at 1900 MHz.

**ABSOLUTE MAXIMUM RATINGS<sup>1</sup>** (T<sub>A</sub> = 25°C)

SYMBOLS	PARAMETERS	UNITS	RATINGS
V <sub>CC</sub>	Supply Voltage	V	4.0
I <sub>CC</sub>	Total Supply Current	mA	15
P <sub>IN</sub>	Input Power	dBm	0
P <sub>T</sub>	Total Power Dissipation <sup>2</sup>	mW	200
T <sub>OP</sub>	Operating Temperature	°C	-40 to +85
T <sub>STG</sub>	Storage Temperature	°C	-55 to +150

Notes:

1. Operation in excess of any one of these parameters may result in permanent damage.
2. Mounted on a 50 x 50 x 1.6 mm epoxy glass PWB (T<sub>A</sub> = 85°C).

**RECOMMENDED OPERATING CONDITIONS**

SYMBOLS	PARAMETERS	UNITS	MIN	TYP	MAX
V <sub>CC</sub>	Supply Voltage	V	2.7	3	3.3
T <sub>OP</sub>	Operating Temperature	°C	-40	25	85

**TEST CIRCUIT**

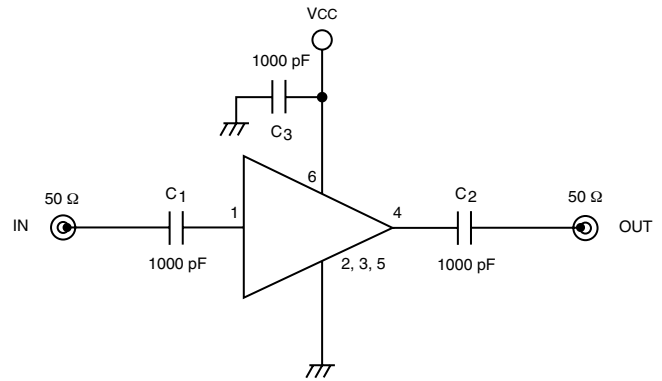

**TYPICAL PERFORMANCE CURVES** (T<sub>A</sub> = 25°C)

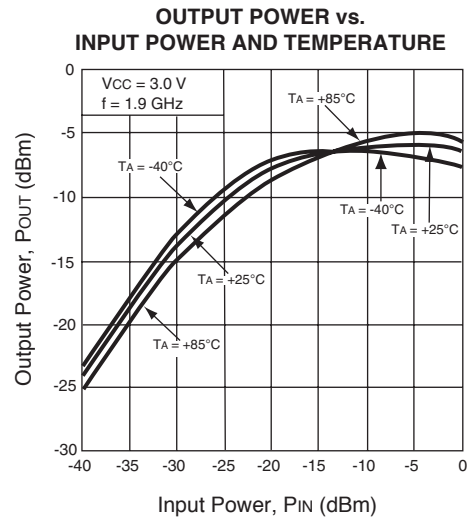
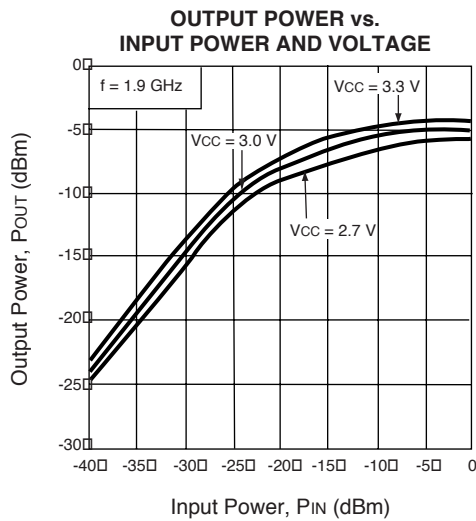
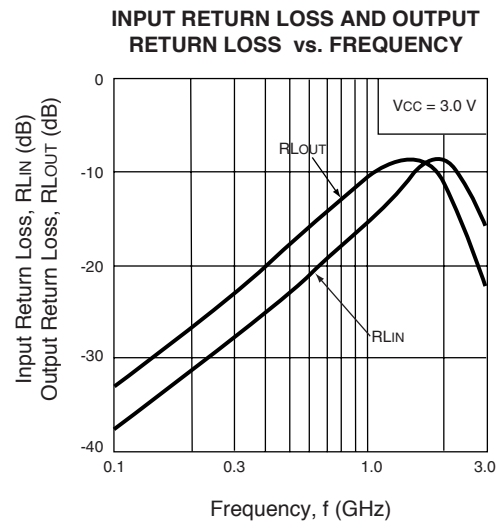
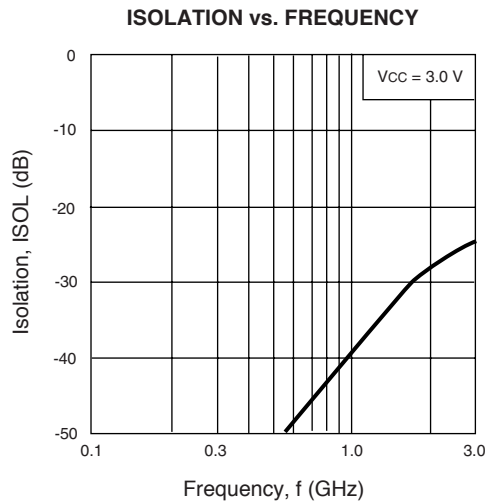

TYPICAL PERFORMANCE CURVES (TA = 25°C)

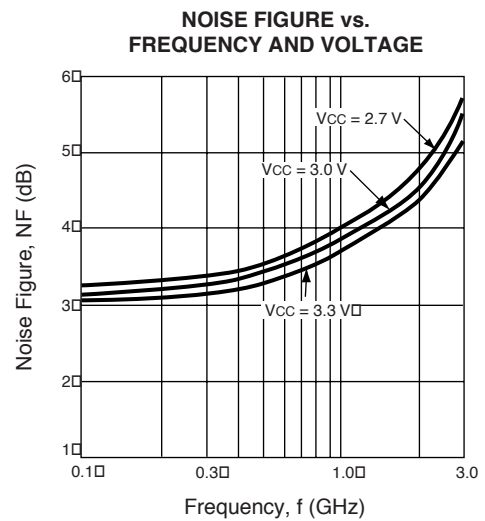
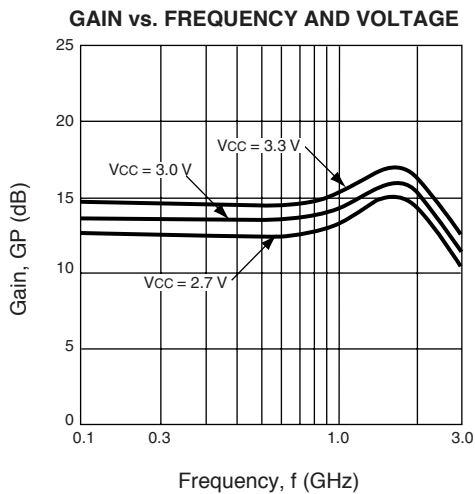
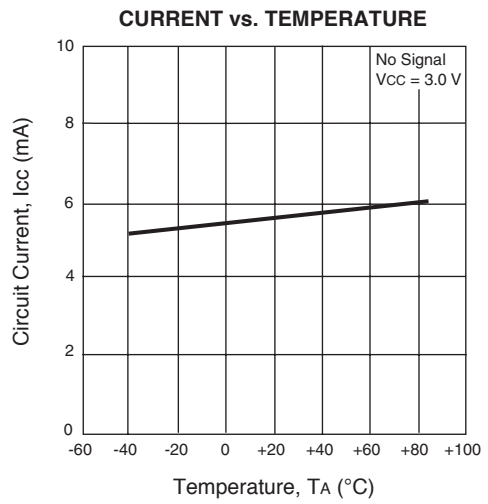
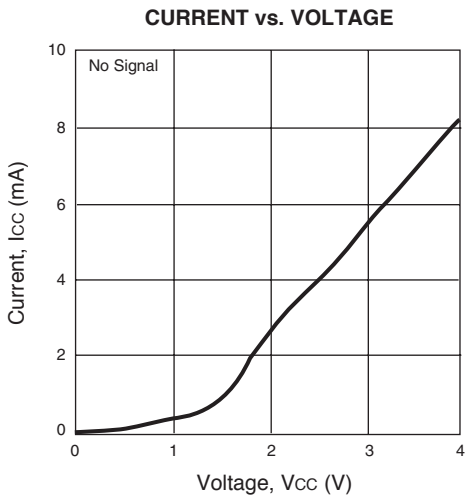
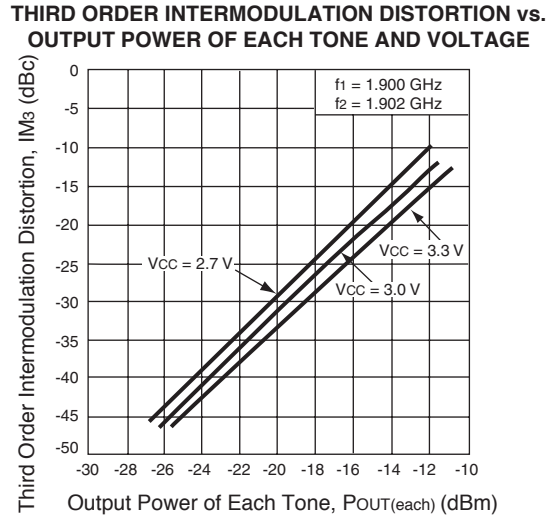
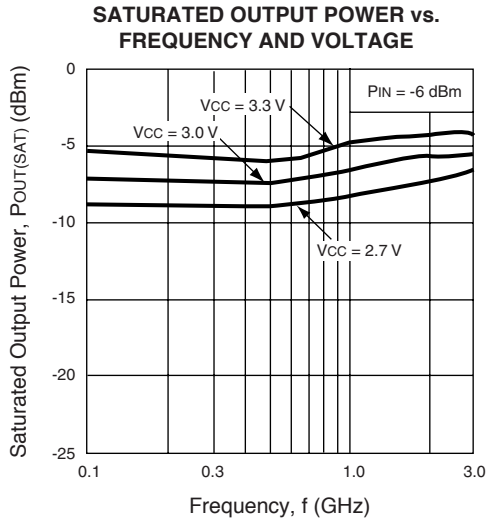

**PIN DESCRIPTION**

Pin No.	Pin Name	Applied Voltage (V)	Pin Voltage (V)	Description	Internal Equivalent Circuit
1	Input	–	0.82	Signal input pin. An internal matching circuit, configured with resistors, enables 50 Ω connection over a wide bandwidth. A multi-feedback circuit is designed to cancel the deviations of hFE and resistance. This pin must be coupled to the signal source with a blocking capacitor.	
4	Output	–	2.87	Signal output pin. An internal matching circuit, configured with resistors, enables 50 Ω connection over a wide bandwidth. This pin must be coupled to the output load with a blocking capacitor.	
6	Vcc	2.7 to 3.3	–	Power supply pin. This pin should be externally equipped with a bypass capacitor to minimize ground impedance.	
2 3 5	GND	0	–	Ground pins. These pins should be connected to system ground with minimum inductance. Ground pattern on the board should be formed as wide as possible. All the ground pins must be connected together with wide ground pattern to minimize impedance difference.	

**SYSTEM APPLICATION EXAMPLE**

**Example of GPS Receiver**

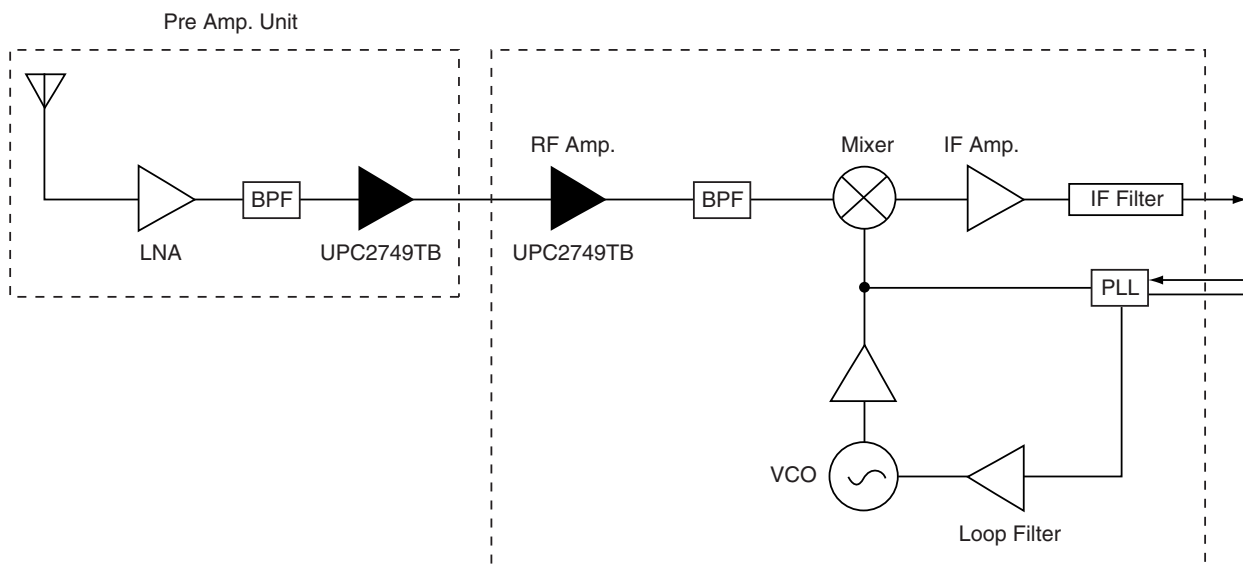

**TYPICAL SCATTERING PARAMETERS** (TA = 25°C)

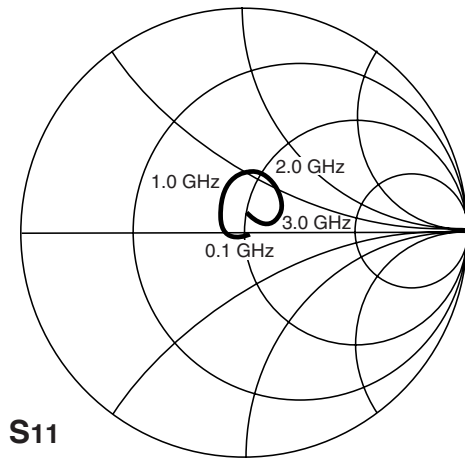

**S11**

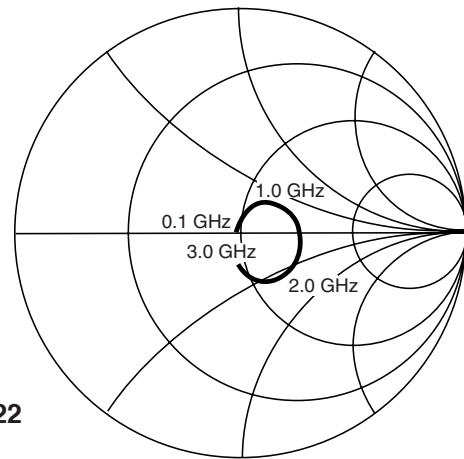

**S22**

Vcc = 3.0 V, Icc = 6.5 mA

FREQUENCY GHz	S11		S21		S12		S22		K
	MAG	ANG	MAG	ANG	MAG	ANG	MAG	ANG	
0.1	0.021	13.0	4.096	-1.9	0.002	-1.1	0.024	165.8	66.82
0.2	0.038	-30.5	4.216	-7.8	0.001	75.4	0.033	113.6	129.26
0.3	0.034	-71.8	4.282	-15.5	0.001	141.5	0.064	96.1	90.16
0.4	0.052	-120.5	4.403	-21.0	0.002	129.9	0.080	87.9	45.30
0.5	0.062	-149.9	4.390	-26.6	0.002	134.1	0.103	76.9	57.58
0.6	0.079	-169.7	4.399	-31.6	0.003	128.3	0.127	68.6	34.08
0.7	0.097	173.6	4.566	-36.7	0.005	132.9	0.151	60.6	22.08
0.8	0.116	160.5	4.667	-41.3	0.007	131.5	0.174	53.7	14.70
0.9	0.134	149.3	4.843	-46.8	0.008	129.3	0.197	44.9	12.29
1.0	0.156	138.8	5.016	-52.6	0.009	124.6	0.220	36.1	10.00
1.1	0.178	128.5	5.305	-60.3	0.014	131.4	0.240	28.0	6.15
1.2	0.195	118.7	5.660	-67.1	0.016	122.5	0.262	17.3	5.13
1.3	0.214	108.7	5.835	-76.2	0.020	118.6	0.279	8.6	3.80
1.4	0.229	99.5	6.148	-84.5	0.022	114.4	0.287	-2.0	3.23
1.5	0.249	89.4	6.364	-93.8	0.025	107.7	0.294	-13.5	2.72
1.6	0.259	79.9	6.611	-103.6	0.028	104.3	0.294	-23.6	2.35
1.7	0.264	69.8	6.577	-113.5	0.032	96.8	0.283	-33.8	2.09
1.8	0.259	60.3	6.549	-123.4	0.034	91.8	0.272	-44.1	1.99
1.9	0.248	50.9	6.407	-132.9	0.036	83.3	0.036	-53.8	1.97
2.0	0.238	43.6	6.321	-140.8	0.037	78.5	0.234	-61.4	1.99
2.1	0.218	35.9	6.046	-148.8	0.038	75.1	0.213	-69.5	2.04
2.2	0.204	30.1	5.862	-156.5	0.039	70.4	0.193	-73.8	2.08
2.3	0.183	25.3	5.696	-163.2	0.040	68.3	0.174	-79.5	2.15
2.4	0.156	21.2	5.430	-170.5	0.041	60.7	0.164	-84.1	2.25
2.5	0.140	18.8	5.282	-176.3	0.042	61.6	0.152	-82.1	2.25
2.6	0.119	18.7	5.013	177.2	0.040	58.1	0.142	-84.5	2.53
2.7	0.095	21.2	4.849	170.9	0.042	55.1	0.146	-85.5	2.46
2.8	0.078	30.0	4.596	164.9	0.042	51.9	0.149	-83.9	2.62
2.9	0.066	44.5	4.446	158.1	0.042	44.7	0.154	-91.8	2.70
3.0	0.070	66.0	4.163	152.3	0.044	41.9	0.171	-92.8	2.73
3.1	0.082	78.1	3.966	145.3	0.042	37.1	0.181	-99.6	2.97

**OUTLINE DIMENSIONS** (Units in mm)

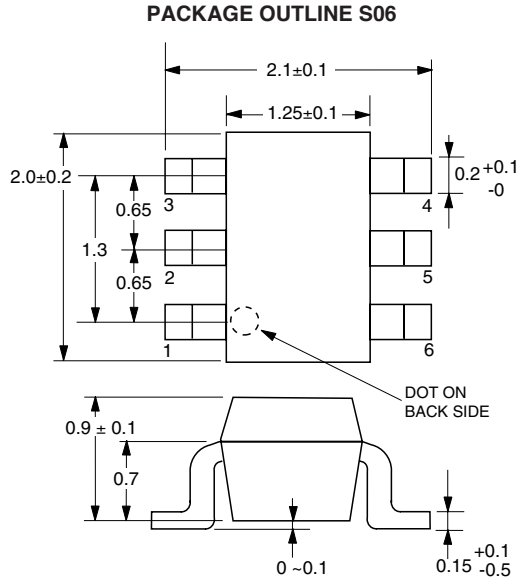

**LEAD CONNECTIONS**

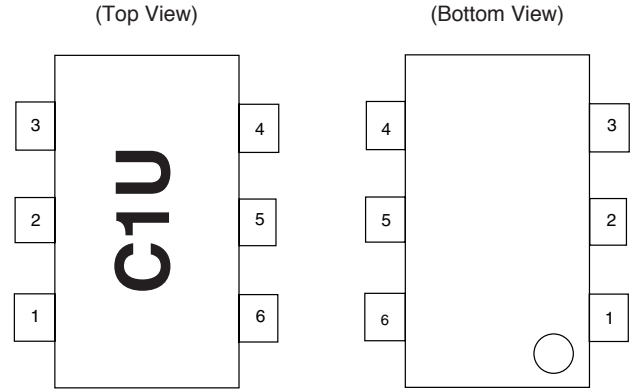

- 1. INPUT
- 2. GND
- 3. GND
- 4. OUTPUT
- 5. GND
- 6. Vcc

**ORDERING INFORMATION**

PART NUMBER	MARKING	QTY
UPC2749TB-E3-A	CIU	3K/Reel

Note:  
 Embossed Tape, 8 mm wide. Pins 1, 2 and 3 face perforated side of tape.

Life Support Applications

These NEC products are not intended for use in life support devices, appliances, or systems where the malfunction of these products can reasonably be expected to result in personal injury. The customers of CEL using or selling these products for use in such applications do so at their own risk and agree to fully indemnify CEL for all damages resulting from such improper use or sale.

EXCLUSIVE NORTH AMERICAN AGENT FOR **NEC** RF, MICROWAVE & OPTOELECTRONIC SEMICONDUCTORS

**CEL CALIFORNIA EASTERN LABORATORIES** • Headquarters • 4590 Patrick Henry Drive • Santa Clara, CA 95054-1817 • (408) 988-3500 • Telex 34-6393 • FAX (408) 988-0279  
 24-Hour Fax-On-Demand: 800-390-3232 (U.S. and Canada only) • Internet: <http://WWW.CEL.COM>

Subject: Compliance with EU Directives

CEL certifies, to its knowledge, that semiconductor and laser products detailed below are compliant with the requirements of European Union (EU) Directive 2002/95/EC Restriction on Use of Hazardous Substances in electrical and electronic equipment (RoHS) and the requirements of EU Directive 2003/11/EC Restriction on Penta and Octa BDE.

CEL Pb-free products have the same base part number with a suffix added. The suffix –A indicates that the device is Pb-free. The –AZ suffix is used to designate devices containing Pb which are exempted from the requirement of RoHS directive (\*). In all cases the devices have Pb-free terminals. All devices with these suffixes meet the requirements of the RoHS directive.

This status is based on CEL’s understanding of the EU Directives and knowledge of the materials that go into its products as of the date of disclosure of this information.

Restricted Substance per RoHS	Concentration Limit per RoHS (values are not yet fixed)	Concentration contained in CEL devices	
		-A	-AZ
Lead (Pb)	< 1000 PPM	Not Detected	(*)
Mercury	< 1000 PPM	Not Detected	
Cadmium	< 100 PPM	Not Detected	
Hexavalent Chromium	< 1000 PPM	Not Detected	
PBB	< 1000 PPM	Not Detected	
PBDE	< 1000 PPM	Not Detected	

If you should have any additional questions regarding our devices and compliance to environmental standards, please do not hesitate to contact your local representative.

Important Information and Disclaimer: Information provided by CEL on its website or in other communications concerning the substance content of its products represents knowledge and belief as of the date that it is provided. CEL bases its knowledge and belief on information provided by third parties and makes no representation or warranty as to the accuracy of such information. Efforts are underway to better integrate information from third parties. CEL has taken and continues to take reasonable steps to provide representative and accurate information but may not have conducted destructive testing or chemical analysis on incoming materials and chemicals. CEL and CEL suppliers consider certain information to be proprietary, and thus CAS numbers and other limited information may not be available for release.

In no event shall CEL’s liability arising out of such information exceed the total purchase price of the CEL part(s) at issue sold by CEL to customer on an annual basis.

See CEL Terms and Conditions for additional clarification of warranties and liability.