

BIPOLAR ANALOG INTEGRATED CIRCUITS

μ PC2757TB, μ PC2758TB

SILICON MMIC 1st FREQUENCY DOWN-CONVERTER FOR CELLULAR/CORDLESS TELEPHONE

DESCRIPTION

The μ PC2757TB and μ PC2758TB are silicon monolithic integrated circuit designed as 1st frequency down-converter for cellular/cordless telephone receiver stage. The ICs consist of mixer and local amplifier. The μ PC2757TB features low current consumption and the μ PC2758TB features improved intermodulation. From these two version, you can chose either IC corresponding to your system design. These TB suffix ICs which are smaller package than conventional T suffix ICs contribute to reduce your system size.

The μ PC2757TB and μ PC2758TB are manufactured using NEC's 20 GHz fr NESAT™III silicon bipolar process. This process uses silicon nitride passivation film and gold electrodes. These materials can protect chip surface from external pollution and prevent corrosion/migration. Thus, this IC has excellent performance, uniformity and reliability.

FEATURES

- Wideband operation : $f_{RFin} = 0.1$ to 2.0 GHz, $f_{FOut} = 20$ to 300 MHz
- High-density surface mounting : 6-pin super minimold package
- Low current consumption : $I_{CC} = 5.6$ mA TYP. @ μ PC2757TB
 $I_{CC} = 11$ mA TYP. @ μ PC2758TB
- Supply voltage : $V_{CC} = 2.7$ to 3.3 V
- Minimized carrier leakage : Due to double balanced mixer
- Equable output impedance : Single-end push-pull IF amplifier
- Built-in power save function

APPLICATIONS

- Cellular/cordless telephone up to 2.0 GHz MAX. (example: GSM, PDC800M, PDC1.5G and so on): μ PC2758TB
- Cellular/cordless telephone up to 2.0 GHz MAX. (example: CT1, CT2 and so on): μ PC2757TB

ORDERING INFORMATION

Part Number	Package	Markings	Supplying Form	Product Type
μ PC2757TB-E3	6-pin super minimold	C1X	Embossed tape 8 mm wide. Pin 1, 2, 3 face the tape perforation side. Qty 3kpcs/reel.	Low current consumption
μ PC2758TB-E3		C1Y		High OIP ₃

Remark To order evaluation samples, please contact your local NEC sales office (Part number for sample order: μ PC2757TB, μ PC2758TB).

Caution Electro-static sensitive devices

The information in this document is subject to change without notice. Before using this document, please confirm that this is the latest version.
Not all devices/types available in every country. Please check with local NEC representative for availability and additional information.

CONTENTS

1. PIN CONNECTIONS..... 3

2. PRODUCT LINE-UP..... 3

3. INTERNAL BLOCK DIAGRAM..... 4

4. SYSTEM APPLICATION EXAMPLE..... 4

5. PIN EXPLANATION 5

6. ABSOLUTE MAXIMUM RATINGS..... 6

7. RECOMMENDED OPERATING RANGE 6

8. ELECTRICAL CHARACTERISTICS 6

9. STANDARD CHARACTERISTICS FOR REFERENCE 7

10. TEST CIRCUIT 8

11. ILLUSTRATION OF THE TEST CIRCUIT ASSEMBLED ON EVALUATION BOARD..... 8

12. TYPICAL CHARACTERISTICS..... 9

 12.1 μPC2757TB..... 9

 12.2 μPC2758TB..... 11

13. S-PARAMETERS 13

 13.1 μPC2757TB..... 13

 13.2 μPC2758TB..... 14

14. PACKAGE DIMENSIONS..... 15

15. NOTE ON CORRECT USE 16

16. RECOMMENDED SOLDERING CONDITIONS 16

1. PIN CONNECTIONS

μ PC2757TB, μ PC2758TB in common

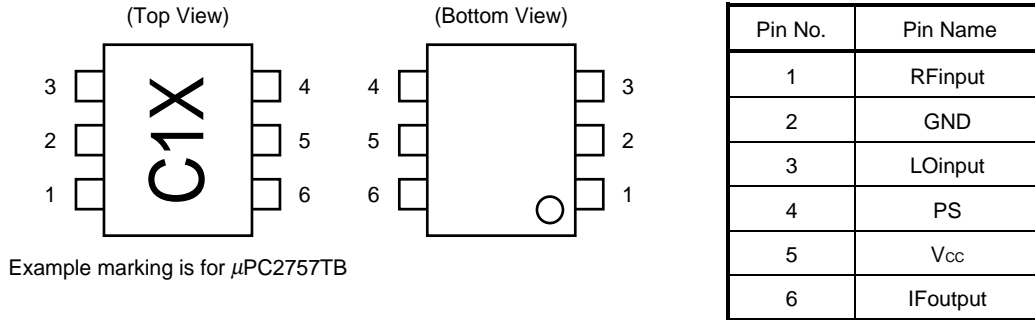

2. PRODUCT LINE-UP (T_A = +25°C, V_{CC} = V_{PS} = 3.0 V, Z_s = Z_L = 50 Ω)

Part No.	Items	No RF I _{cc} (mA)	900 MHz SSB · NF (dB)	1.5 GHz SSB · NF (dB)	1.9 GHz SSB · NF (dB)	900 MHz CG (dB)	1.5 GHz CG (dB)	1.9 GHz CG (dB)	900 MHz IIP ₃ (dBm)	1.5 GHz IIP ₃ (dBm)	1.9 GHz IIP ₃ (dBm)
μ PC2757T	5.6	10	10	13	15	15	13	-14	-14	-12	
μ PC2757TB											
μ PC2758T	11	9	10	13	19	18	17	-13	-12	-11	
μ PC2758TB											
μ PC8112T	8.5	9	11	11	15	13	13	-10	-9	-7	
μ PC8112TB											

Part No.	Items	900 MHz P _{O(sat)} (dBm)	1.5 GHz P _{O(sat)} (dBm)	1.9 GHz P _{O(sat)} (dBm)	900 MHz RF _{Lo} (dB)	1.5 GHz RF _{Lo} (dB)	1.9 GHz RF _{Lo} (dB)	IF Output Configuration	Packages
μ PC2757T	-3	-	-8	-	-	-	-	Emitter follower	6-pin minimold
μ PC2757TB									6-pin super minimold
μ PC2758T	+1	-	-4	-	-	-	6-pin minimold		
μ PC2758TB							6-pin super minimold		
μ PC8112T	-2.5	-3	-3	-80	-57	-55	Open collector	6-pin minimold	
μ PC8112TB								6-pin super minimold	

Remark Typical performance. Please refer to ELECTRICAL CHARACTERISTICS in detail.

- Cautions**
1. The μ PC2757 and μ PC2758's IIP₃ are calculated with Δ IM₃ = 3 which is the same IM₃ inclination as μ PC8112. On the other hand, OIP₃ of Standard characteristics in page 7 is cross point IP.
 2. This document is to be specified for μ PC2757TB, μ PC2758TB. The other part number mentioned in this document should be referred to the data sheet of each part number.

3. INTERNAL BLOCK DIAGRAM (μ PC2757TB, μ PC2758TB in common)

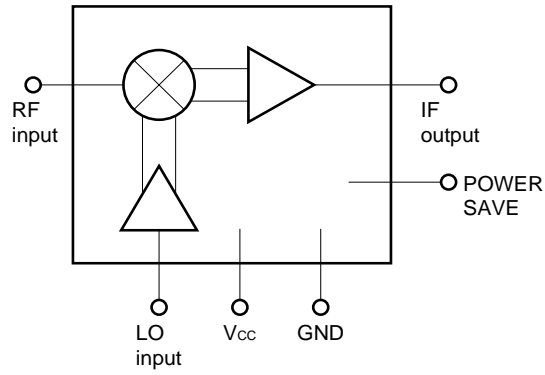

4. SYSTEM APPLICATION EXAMPLE

DIGITAL CELLULAR TELEPHONE

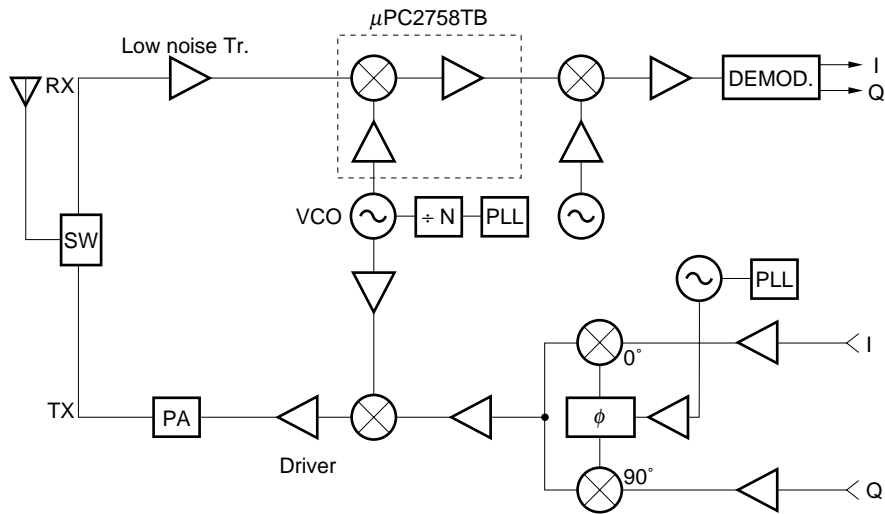

5. PIN EXPLANATION (Both μPC2757TB, 2758TB)

Pin No.	Pin Name	Applied Voltage (V)	Pin Voltage (V) ^{Note}	Function and Application	Internal Equivalent Circuit								
1	RFinput	–	1.2	This pin is RF input for mixer designed as double balance type. This circuit contributes to suppress spurious signal with minimum LO and bias power consumption. Also this symmetrical circuit can keep specified performance insensitive to process-condition distribution.									
2	GND	GND	–	This pin is ground of IC. Must be connected to the system ground with minimum inductance. Ground pattern on the board should be formed as wide as possible. (Track length should be kept as short as possible.)	–								
3	LOinput	–	1.3	This pin is LO input for local buffer designed as differential amplifier. Recommendable input level is –15 to 0 dBm. Also this symmetrical circuit can keep specified performance insensitive to process-condition distribution.									
4	PS	Vcc or GND	–	This pin is for power-save function. This pin can control ON/OFF operation with bias as follows; <table border="1" style="margin: 10px auto;"> <thead> <tr> <th></th> <th>Bias: V</th> <th>Operation</th> </tr> </thead> <tbody> <tr> <td rowspan="2">V_{PS}</td> <td>≥ 2.5</td> <td>ON</td> </tr> <tr> <td>0 to 0.5</td> <td>OFF</td> </tr> </tbody> </table> Rise time/fall time using this pin are approximately 10 μs.		Bias: V	Operation	V _{PS}	≥ 2.5	ON	0 to 0.5	OFF	
	Bias: V	Operation											
V _{PS}	≥ 2.5	ON											
	0 to 0.5	OFF											
5	Vcc	2.7 to 3.3	–	Supply voltage 3.0 ±0.3 V for operation. Must be connected bypass capacitor. (example: 1 000 pF) to minimize ground impedance.	–								
6	IFoutput	–	1.7	This pin is output from IF buffer amplifier designed as single-ended push-pull type. This pin is assigned for emitter follower output with low-impedance. In the case of connecting to high-impedance stage, please attach external matching circuit.									

Note Each pin voltage is measured at Vcc = 3.0 V

6. ABSOLUTE MAXIMUM RATINGS

Parameter	Symbol	Conditions	Ratings	Unit
Supply Voltage	V _{CC}	T _A = +25°C	5.5	V
★ Power Dissipation of Package Allowance	P _D	Mounted on 50 × 50 × 1.6 mm double sided copper clad epoxy glass board at T _A = +85°C	270	mW
Operating Ambient Temperature	T _A		-40 to +85	°C
Storage Temperature	T _{stg}		-55 to +150	°C
PS Pin Voltage	V _{PS}	T _A = +25°C	5.5	V

7. RECOMMENDED OPERATING RANGE

Parameter	Symbol	MIN.	TYP.	MAX.	Unit
Supply Voltage	V _{CC}	2.7	3.0	3.3	V
Operating Ambient Temperature	T _A	-40	+25	+85	°C
LO Input Power	P _{LOin}	-15	-10	0	dBm

8. ELECTRICAL CHARACTERISTICS (T_A = +25°C, V_{CC} = V_{PS} = 3.0 V, P_{LOin} = -10 dBm, Z_S = Z_L = 50 Ω)

Parameter	Symbol	Conditions	μ PC2757TB			μ PC2758TB			Unit
			MIN.	TYP.	MAX.	MIN.	TYP.	MAX.	
Circuit Current	I _{CC}	No input signal	3.7	5.6	7.7	6.6	11	14.8	mA
RF Input Frequency	f _{RFIn}	CG ≥ (CG1 -3 dB) f _{IFout} = 130 MHz constant	0.1	-	2.0	0.1	-	2.0	GHz
IF Output Frequency	f _{IFout}	CG ≥ (CG1 -3 dB) f _{RFIn} = 0.8 GHz constant	20	-	300	20	-	300	MHz
Conversion Gain 1	CG1	f _{RFIn} = 0.8 GHz, f _{IFout} = 130 MHz P _{RFIn} = -40 dBm, Upper local	12	15	18	16	19	22	dB
Conversion Gain 2	CG2	f _{RFIn} = 2.0 GHz, f _{IFout} = 250 MHz P _{RFIn} = -40 dBm, Lower local	10	13	16	14	17	20	dB
SSB Noise Figure 1	SSB • NF1	f _{RFIn} = 0.8 GHz, f _{IFout} = 130 MHz, SSB mode, Upper local	-	10	13	-	9	12	dB
SSB Noise Figure 2	SSB • NF2	f _{RFIn} = 2.0 GHz, f _{IFout} = 250 MHz, SSB mode, Lower local	-	13	16	-	13	15	dB
Saturated Output Power 1	P _{O(sat) 1}	f _{RFIn} = 0.8 GHz, f _{IFout} = 130 MHz P _{RFIn} = -10 dBm, Upper local	-11	-3	-	-7	+1	-	dBm
Saturated Output Power 2	P _{O(sat) 2}	f _{RFIn} = 2.0 GHz, f _{IFout} = 250 MHz P _{RFIn} = -10 dBm, Lower local	-11	-8	-	-7	-4	-	dBm

9. STANDARD CHARACTERISTICS FOR REFERENCE

(Unless otherwise specified: $T_A = +25^\circ\text{C}$, $V_{CC} = V_{PS} = 3.0\text{ V}$, $P_{LOin} = -10\text{ dBm}$, $Z_S = Z_L = 50\ \Omega$)

Parameter	Symbol	Conditions	Reference Value		Unit
			μ PC2757TB	μ PC2758TB	
3rd Order Distortion Output Intercept Point	OIP ₃	$f_{RFin} = 0.8\text{ to }2.0\text{ GHz}$, $f_{Fout} = 0.1\text{ GHz}$, Cross point IP	+5	+11	dBm
LO Leakage at RF pin	LO _{rf}	$f_{LOin} = 0.8\text{ to }2.0\text{ GHz}$	-35	-30	dBm
LO Leakage at IF pin	LO _{if}	$f_{LOin} = 0.8\text{ to }2.0\text{ GHz}$	-23	-15	dBm
Circuit Current at Power Save Mode	I _{cc(PS)}	$V_{PS} = 0.5\text{ V}$	0.1	0.1	μA

10. TEST CIRCUIT

μ PC2757TB, μ PC2758TB

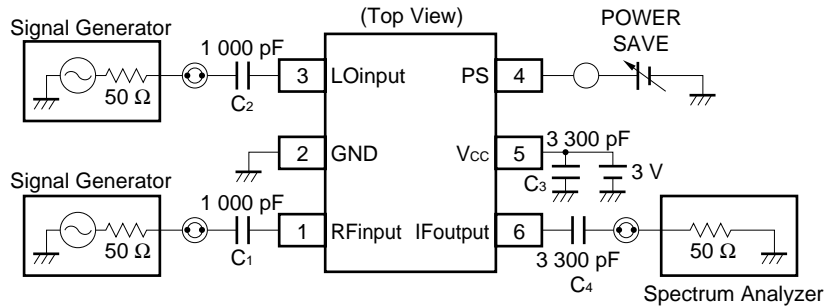

★ 11. ILLUSTRATION OF THE TEST CIRCUIT ASSEMBLED ON EVALUATION BOARD

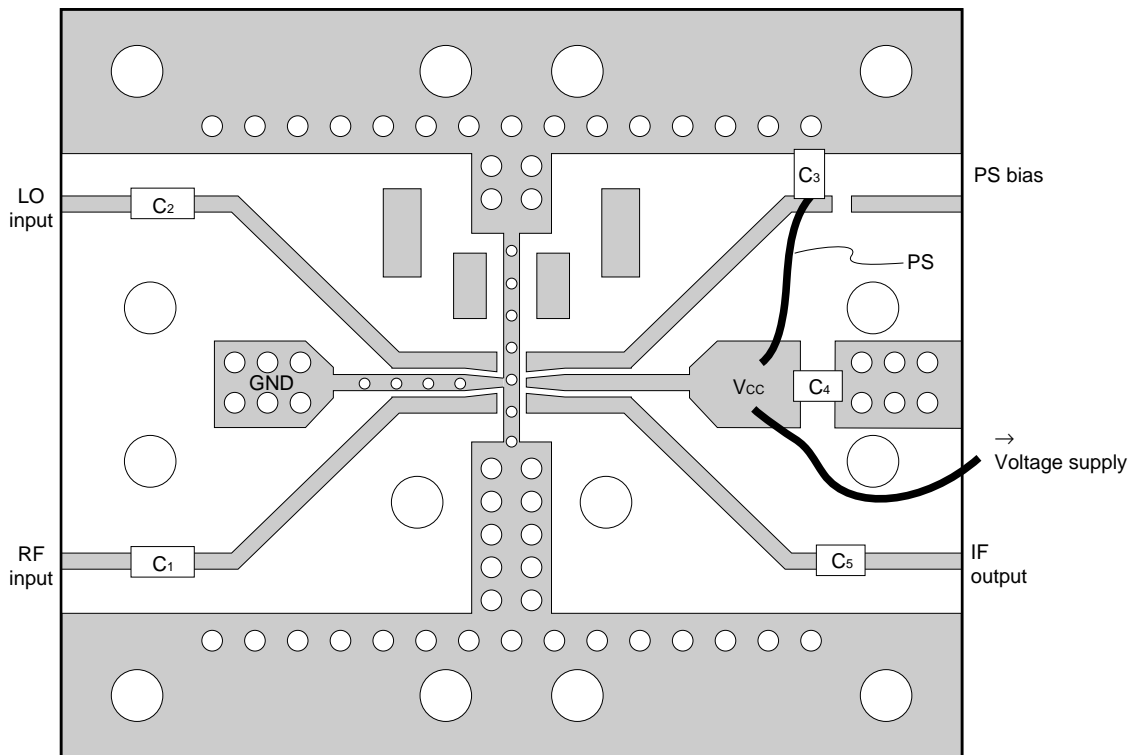

Component List

No.	Value
C ₁ , C ₂	1 000 pF
C ₃ to C ₅	3 300 pF

Notes 1. 35 × 42 × 0.4 mm double sided copper clad polyimide board.

- 2. Back side: GND pattern
- 3. Solder plated on pattern
- 4. °O: Through holes

Application explanation

This IC is guaranteed on the test circuit constructed with 50 Ω equipment and transmission line.

This IC, however, does not have 50 Ω input/output impedance, but electrical characteristics such as conversion gain and intermodulation distortion are described herein on these conditions without impedance matching. So, you should understand that conversion gain and intermodulation distortion at input level will vary when you improve VS of RF input with external circuit (50 Ω termination or impedance matching.)

12. TYPICAL CHARACTERISTICS (TA = +25°C, on Measurement Circuit)

12.1 μ PC2757TB

CIRCUIT CURRENT vs. SUPPLY VOLTAGE

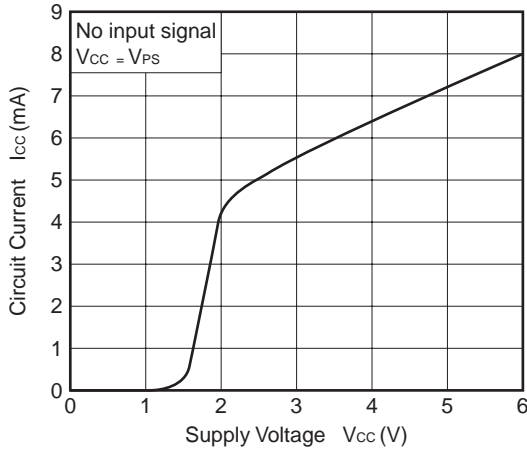

CONVERSION GAIN vs. RF INPUT FREQUENCY

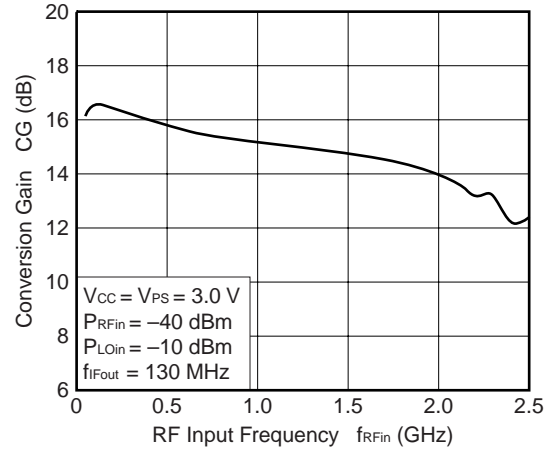

SSB NOISE FIGURE vs. RF INPUT FREQUENCY

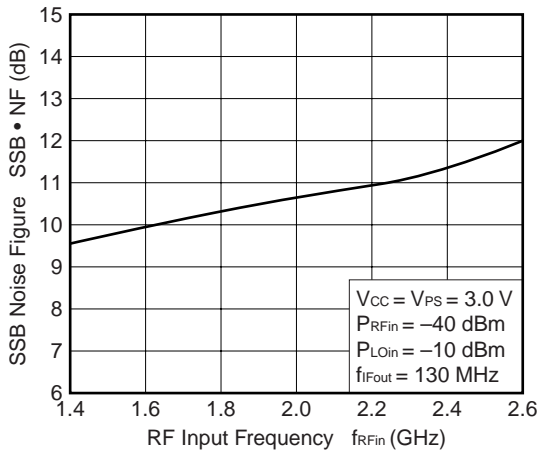

CONVERSION GAIN vs. IF OUTPUT FREQUENCY

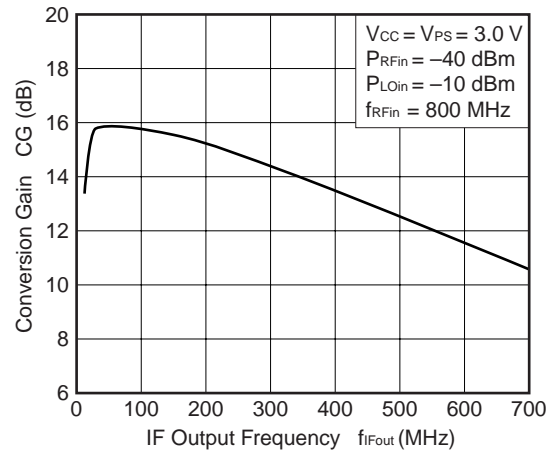

CONVERSION GAIN vs. LO INPUT POWER

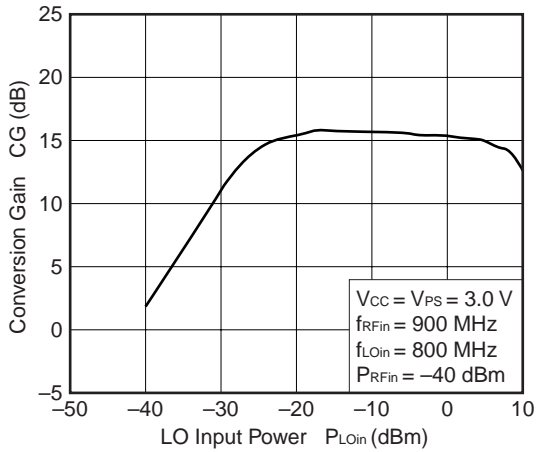

CONVERSION GAIN vs. LO INPUT POWER

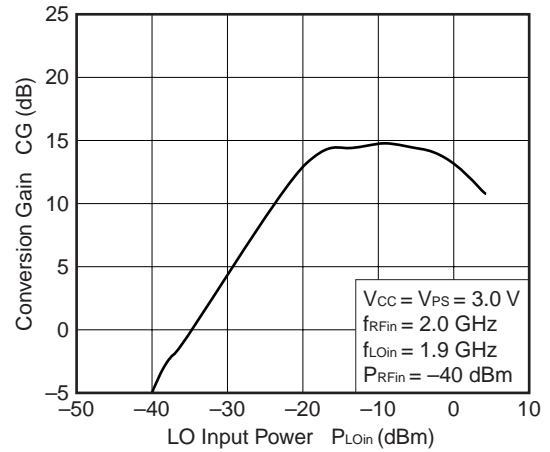

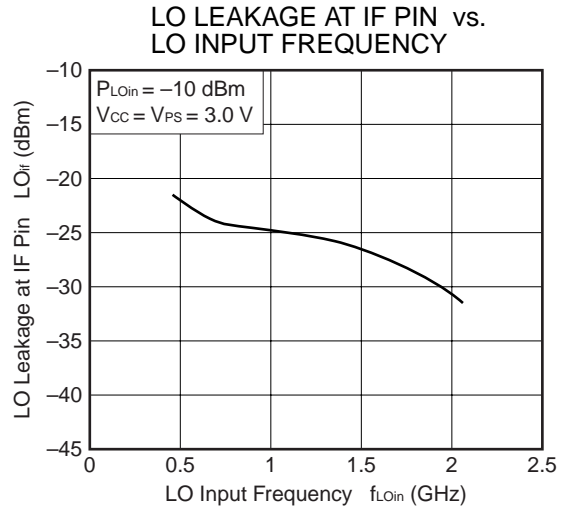
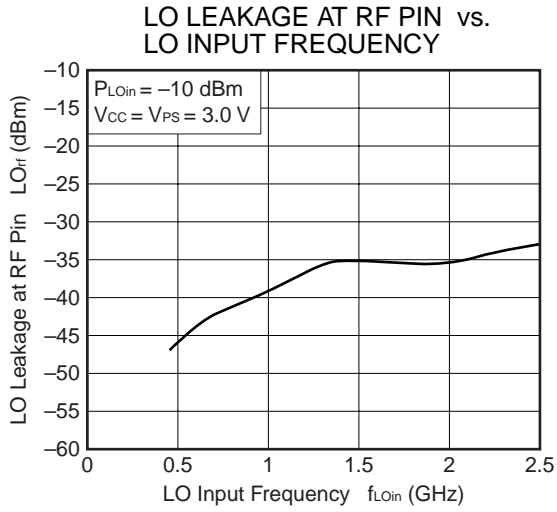
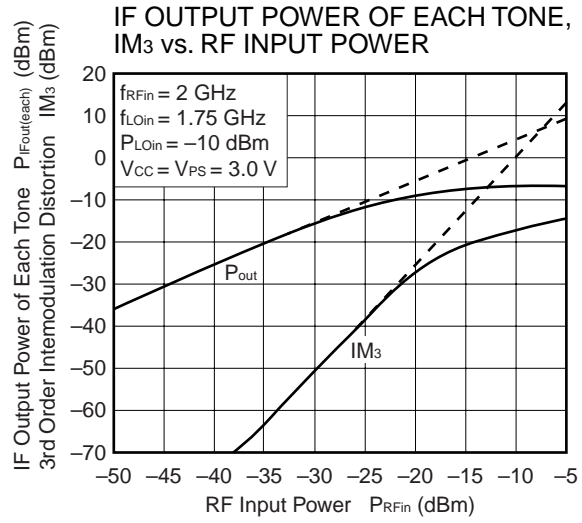
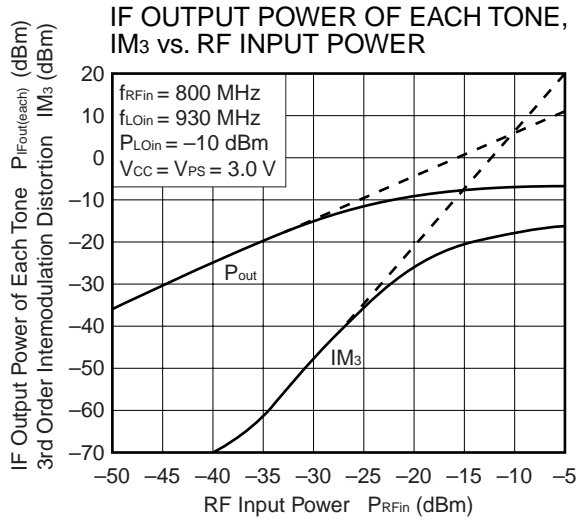

Remark The graphs indicate nominal characteristics.

12.2 μ PC2758TB

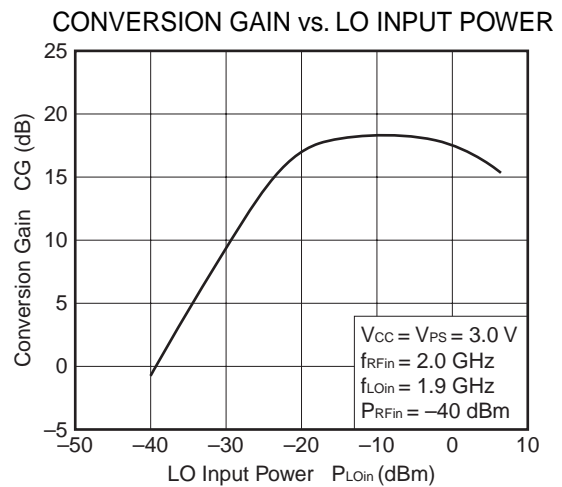
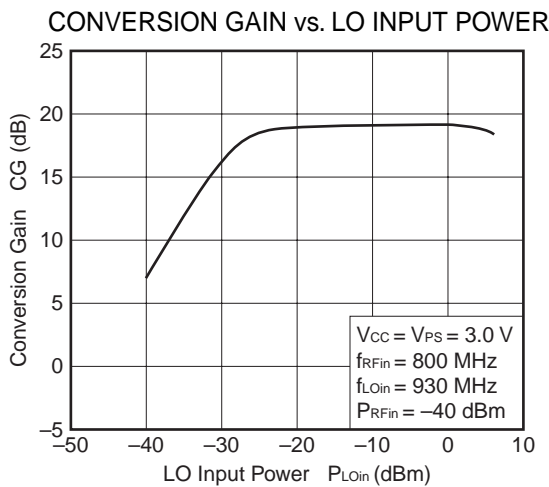
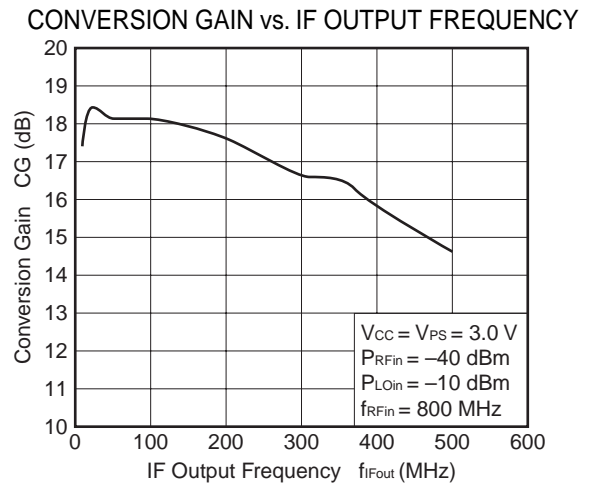
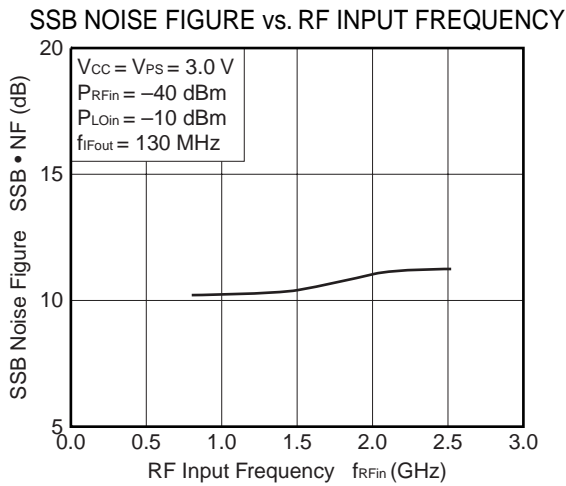
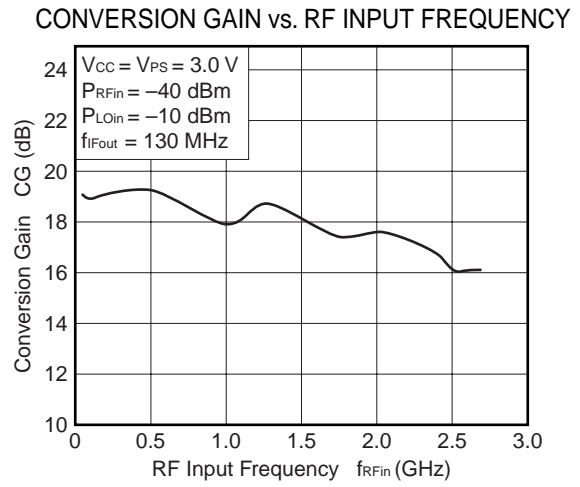
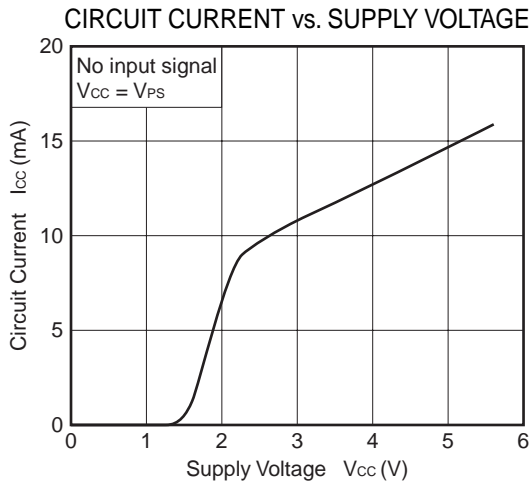

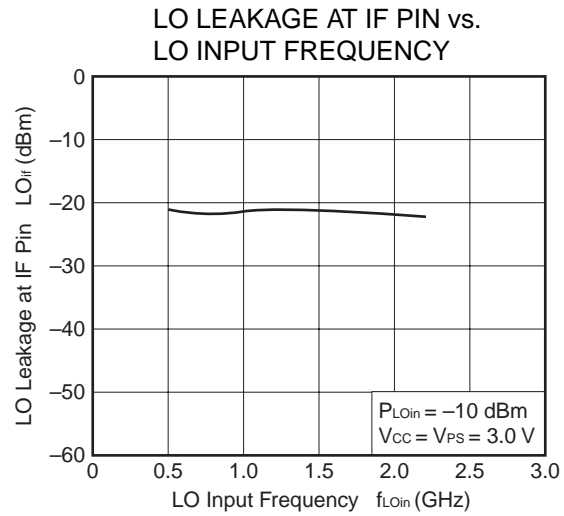
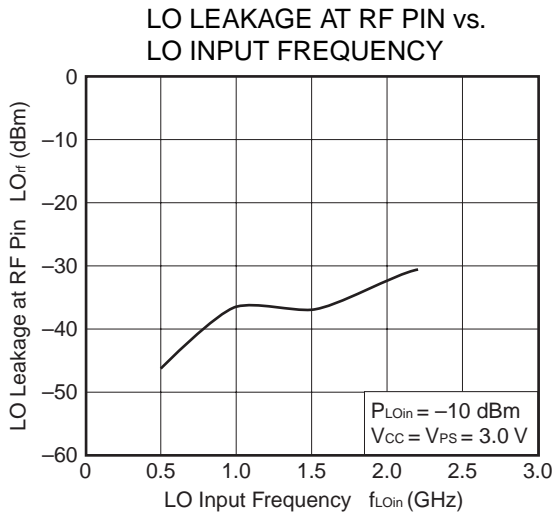
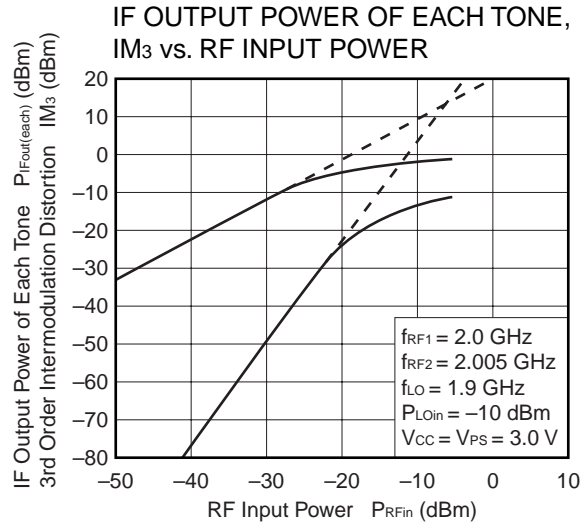
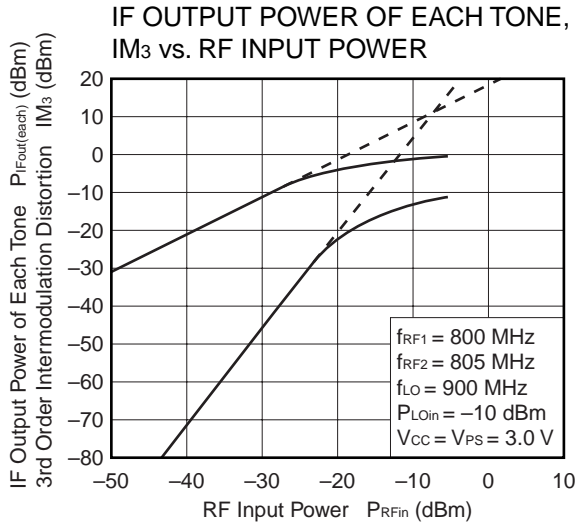

Remark The graphs indicate nominal characteristics.

13. S-PARAMETERS

13.1 μ PC2757TB

Calibrated on pin of DUT

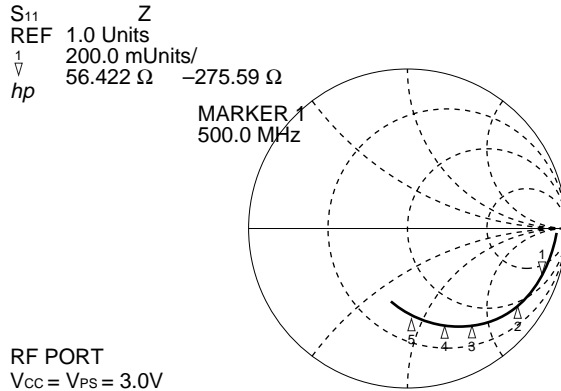

RF PORT
 V_{CC} = V_{PS} = 3.0V
 1:500 MHz 56.422 Ω -j275.59 Ω START 0.050000000 GHz
 2:900 MHz 38.68 Ω -j152.71 Ω STOP 3.000000000 GHz
 3:1 500 MHz 31.699 Ω -j88.102 Ω
 4:1 900 MHz 29.209 Ω -j65.926 Ω
 5:2 500 MHz 29.209 Ω -j44.758 Ω

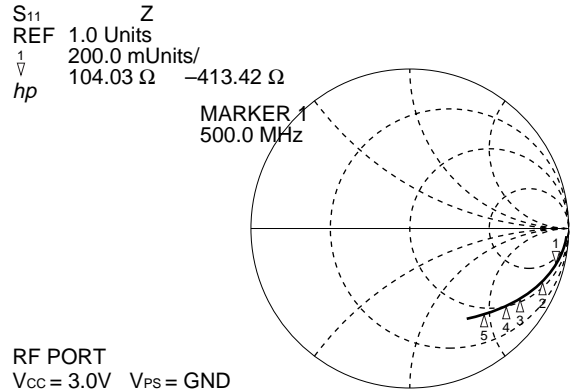

RF PORT
 V_{CC} = 3.0V V_{PS} = GND
 1:500 MHz 104.03 Ω -j413.42 Ω START 0.050000000 GHz
 2:900 MHz 74.82 Ω -j243.06 Ω STOP 3.000000000 GHz
 3:1 500 MHz 59.266 Ω -j154.98 Ω
 4:1 900 MHz 51.227 Ω -j124.55 Ω
 5:2 500 MHz 43.996 Ω -j95.117 Ω

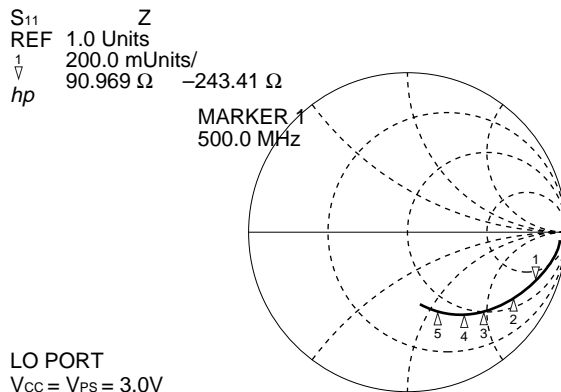

LO PORT
 V_{CC} = V_{PS} = 3.0V
 1:500 MHz 90.969 Ω -j243.41 Ω START 0.050000000 GHz
 2:900 MHz 67.828 Ω -j150.32 Ω STOP 3.000000000 GHz
 3:1 500 MHz 51.488 Ω -j97.273 Ω
 4:1 900 MHz 44.621 Ω -j77.352 Ω
 5:2 500 MHz 39.627 Ω -j56.738 Ω

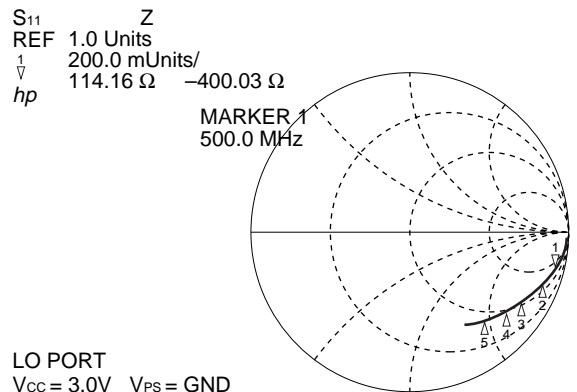

LO PORT
 V_{CC} = 3.0V V_{PS} = GND
 1:500 MHz 114.16 Ω -j400.03 Ω START 0.050000000 GHz
 2:900 MHz 75.133 Ω -j242.73 Ω STOP 3.000000000 GHz
 3:1 500 MHz 53.516 Ω -j154.21 Ω
 4:1 900 MHz 44.789 Ω -j124.74 Ω
 5:2 500 MHz 37.004 Ω -j93.828 Ω

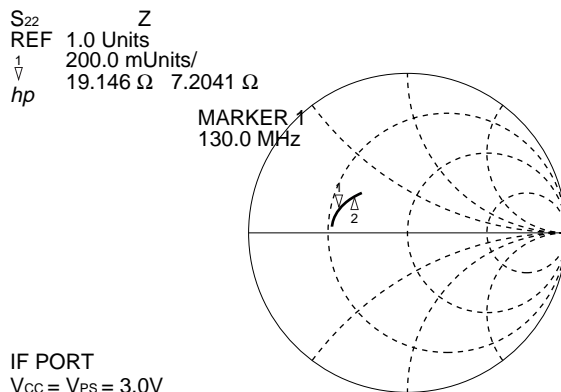

IF PORT
 V_{CC} = V_{PS} = 3.0V
 1:130 MHz 19.146 Ω -j7.2041 Ω START 0.050000000 GHz
 2:250 MHz 22.73 Ω -j12.909 Ω STOP 3.000000000 GHz

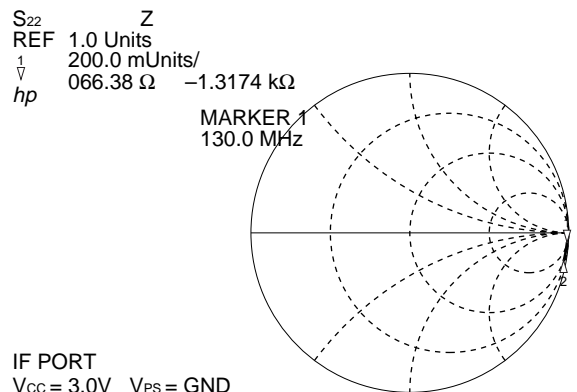

IF PORT
 V_{CC} = 3.0V V_{PS} = GND
 1:130 MHz 66.38 Ω -j1.3174 k Ω START 0.050000000 GHz
 2:250 MHz 88.281 Ω -j725.41 Ω STOP 3.000000000 GHz

13.2 μ PC2758TB

Calibrated on pin of DUT

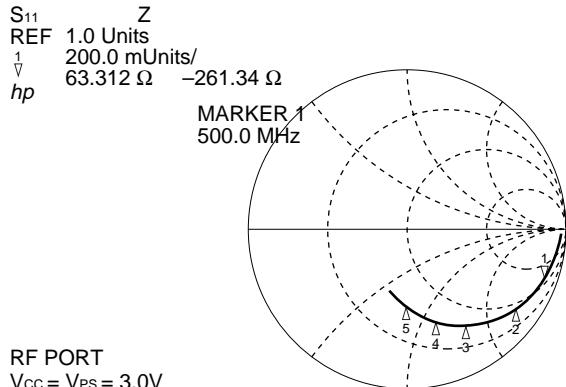

RF PORT
V_{CC} = V_{PS} = 3.0V

1:500 MHz	63.312 Ω -j261.34 Ω	START 0.050000000 GHz
2:900 MHz	40.227 Ω -j142.36 Ω	STOP 3.000000000 GHz
3:1 500 MHz	32.441 Ω -j79.68 Ω	
4:1 900 MHz	31.107 Ω -j58.273 Ω	
5:2 500 MHz	30.871 Ω -j39.08 Ω	

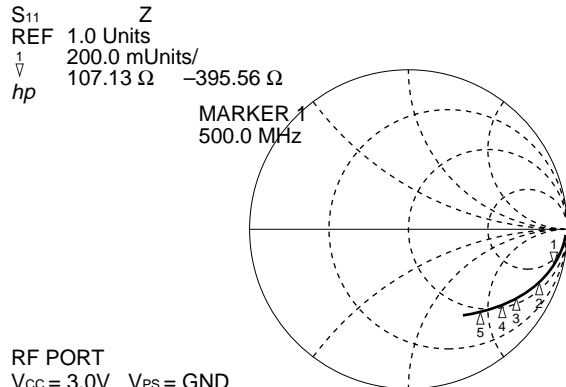

RF PORT
V_{CC} = 3.0V V_{PS} = GND

1:500 MHz	107.13 Ω -j395.56 Ω	START 0.050000000 GHz
2:900 MHz	78.711 Ω -j234.41 Ω	STOP 3.000000000 GHz
3:1 500 MHz	61.922 Ω -j148.82 Ω	
4:1 900 MHz	52.629 Ω -j119.55 Ω	
5:2 500 MHz	44.766 Ω -j90.578 Ω	

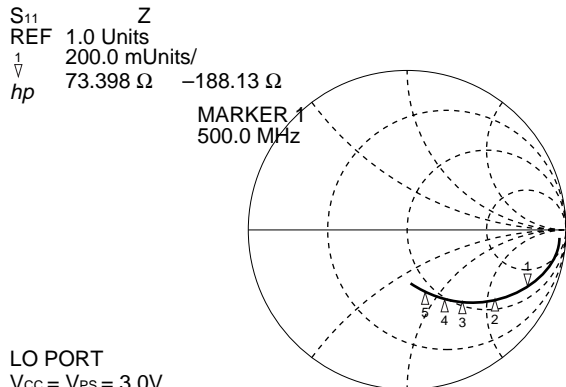

LO PORT
V_{CC} = V_{PS} = 3.0V

1:500 MHz	73.398 Ω -j188.13 Ω	START 0.050000000 GHz
2:900 MHz	64.551 Ω -j112.66 Ω	STOP 3.000000000 GHz
3:1 500 MHz	53.133 Ω -j72.941 Ω	
4:1 900 MHz	48.111 Ω -j57.307 Ω	
5:2 500 MHz	44.541 Ω -j41.564 Ω	

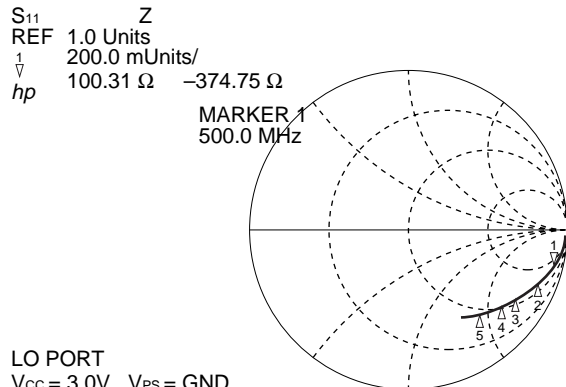

LO PORT
V_{CC} = 3.0V V_{PS} = GND

1:500 MHz	100.31 Ω -j374.75 Ω	START 0.050000000 GHz
2:900 MHz	73.148 Ω -j223.07 Ω	STOP 3.000000000 GHz
3:1 500 MHz	57.719 Ω -j144.02 Ω	
4:1 900 MHz	50.738 Ω -j119.52 Ω	
5:2 500 MHz	41.836 Ω -j90.25 Ω	

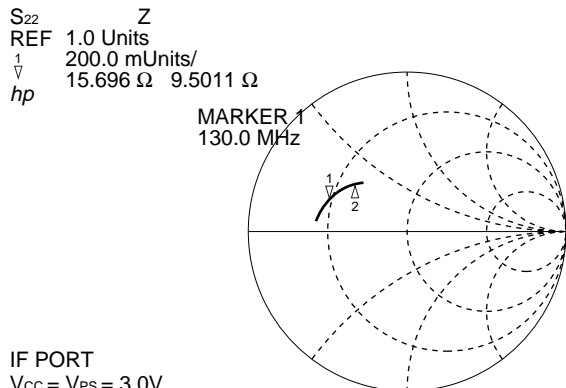

IF PORT
V_{CC} = V_{PS} = 3.0V

1:130 MHz	15.696 Ω -j9.5811 Ω	START 0.050000000 GHz
2:250 MHz	21.4 Ω -j16.331 Ω	STOP 3.000000000 GHz

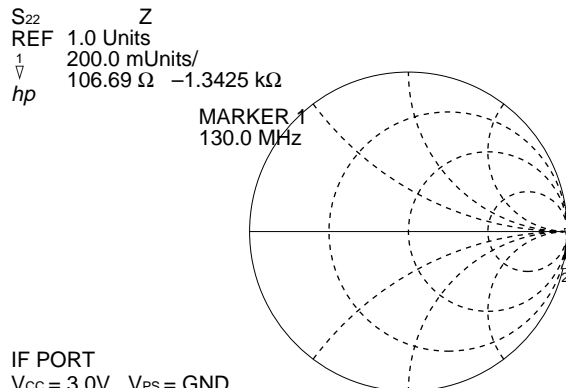

IF PORT
V_{CC} = 3.0V V_{PS} = GND

1:130 MHz	106.69 Ω -j1.3425 k Ω	START 0.050000000 GHz
2:250 MHz	83.75 Ω -j711.47 Ω	STOP 3.000000000 GHz

★ 14. PACKAGE DIMENSIONS

6-PIN SUPER MINIMOLD (UNIT: mm)

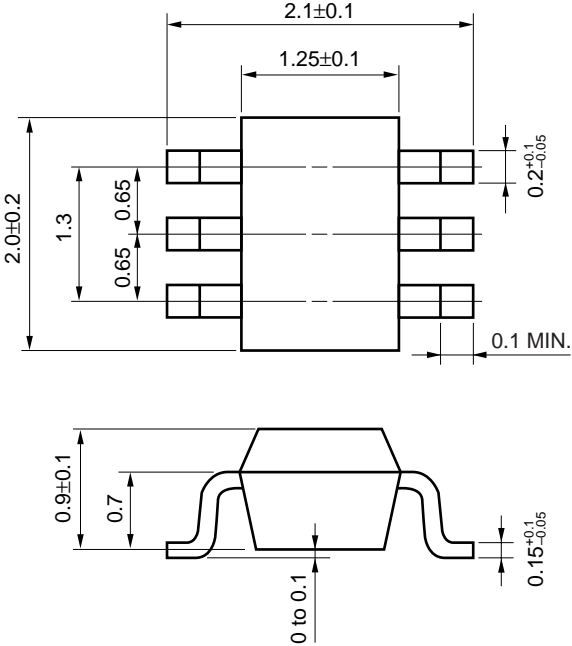

15. NOTE ON CORRECT USE

- (1) Observe precautions for handling because of electrostatic sensitive devices.
- (2) Form a ground pattern as widely as possible to minimize ground impedance (to prevent undesired oscillation).
Keep the track length of the ground pins as short as possible.
- (3) Connect a bypass capacitor (example: 1 000 pF) to the Vcc pin.
- (4) The DC cut capacitor must be attached to input pin.

16. RECOMMENDED SOLDERING CONDITIONS

This product should be soldered under the following recommended conditions. For soldering methods and conditions other than those recommended below, contact your NEC sales representative.

Soldering Method	Soldering Condition	Recommended Condition Symbol
Infrared Reflow	Package peak temperature: 235°C or below Time: 30 seconds or less (at 210°C) Count: 3, Exposure limit: None ^{Note}	IR35-00-3
VPS	Package peak temperature: 215°C or below Time: 40 seconds or less (at 200°C) Count: 3, Exposure limit: None ^{Note}	VP15-00-3
Wave Soldering	Soldering bath temperature: 260°C or below Time: 10 seconds or less Count: 1, Exposure limit: None ^{Note}	WS60-00-1
Partial Heating	Pin temperature: 300°C Time: 3 seconds or less (per side of device) Exposure limit: None ^{Note}	–

Note After opening the dry pack, keep it in a place below 25°C and 65% RH for the allowable storage period.

Caution Do not use different soldering methods together (except for partial heating).

For details of recommended soldering conditions for surface mounting, refer to information document SEMICONDUCTOR DEVICE MOUNTING TECHNOLOGY MANUAL (C10535E).

[MEMO]

[MEMO]

[MEMO]

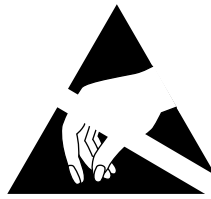

ATTENTION

OBSERVE PRECAUTIONS
FOR HANDLING
ELECTROSTATIC
SENSITIVE
DEVICES

NESAT (NEC Silicon Advanced Technology) is a trademark of NEC Corporation.

• The information in this document is current as of November, 2000. The information is subject to change without notice. For actual design-in, refer to the latest publications of NEC's data sheets or data books, etc., for the most up-to-date specifications of NEC semiconductor products. Not all products and/or types are available in every country. Please check with an NEC sales representative for availability and additional information.

• No part of this document may be copied or reproduced in any form or by any means without prior written consent of NEC. NEC assumes no responsibility for any errors that may appear in this document.

• NEC does not assume any liability for infringement of patents, copyrights or other intellectual property rights of third parties by or arising from the use of NEC semiconductor products listed in this document or any other liability arising from the use of such products. No license, express, implied or otherwise, is granted under any patents, copyrights or other intellectual property rights of NEC or others.

• Descriptions of circuits, software and other related information in this document are provided for illustrative purposes in semiconductor product operation and application examples. The incorporation of these circuits, software and information in the design of customer's equipment shall be done under the full responsibility of customer. NEC assumes no responsibility for any losses incurred by customers or third parties arising from the use of these circuits, software and information.

• While NEC endeavours to enhance the quality, reliability and safety of NEC semiconductor products, customers agree and acknowledge that the possibility of defects thereof cannot be eliminated entirely. To minimize risks of damage to property or injury (including death) to persons arising from defects in NEC semiconductor products, customers must incorporate sufficient safety measures in their design, such as redundancy, fire-containment, and anti-failure features.

• NEC semiconductor products are classified into the following three quality grades:

"Standard", "Special" and "Specific". The "Specific" quality grade applies only to semiconductor products developed based on a customer-designated "quality assurance program" for a specific application. The recommended applications of a semiconductor product depend on its quality grade, as indicated below. Customers must check the quality grade of each semiconductor product before using it in a particular application.

"Standard": Computers, office equipment, communications equipment, test and measurement equipment, audio and visual equipment, home electronic appliances, machine tools, personal electronic equipment and industrial robots

"Special": Transportation equipment (automobiles, trains, ships, etc.), traffic control systems, anti-disaster systems, anti-crime systems, safety equipment and medical equipment (not specifically designed for life support)

"Specific": Aircraft, aerospace equipment, submersible repeaters, nuclear reactor control systems, life support systems and medical equipment for life support, etc.

The quality grade of NEC semiconductor products is "Standard" unless otherwise expressly specified in NEC's data sheets or data books, etc. If customers wish to use NEC semiconductor products in applications not intended by NEC, they must contact an NEC sales representative in advance to determine NEC's willingness to support a given application.

(Note)

(1) "NEC" as used in this statement means NEC Corporation and also includes its majority-owned subsidiaries.

(2) "NEC semiconductor products" means any semiconductor product developed or manufactured by or for NEC (as defined above).