

BIPOLAR ANALOG INTEGRATED CIRCUIT

μ PC1094

**SWITCHING REGULATOR CONTROL CIRCUIT
FOR 500 kHz OPERATION**

DESCRIPTION

μ PC1094C, μ PC1094G are PWM type switching regulator control circuit up to 500 kHz switching frequency.

These devices feature low standby current, totem pole output circuit which can directly drive the gate of power MOS FET at high speed, and various protection circuits.

These devices are optimum choice for the single ended primary control method switching regulator.

FEATURES

- Directly switching the gate of an external power MOS FET at high speed. ($I_{C(peak)} = 1.2 A$)
- Low supply current.
- Internal low voltage stop circuit.
- Internal ON/OFF control circuit.
- Over current sense pin appendant.
- Capable of master slave operation.

ORDERING INFORMATION

Part Number	Package
μ PC1094C	14-PIN PLASTIC DIP (300 mil)
μ PC1094G	14-PIN PLASTIC SOP (225 mil)

CONNECTION DIAGRAM (Top View)

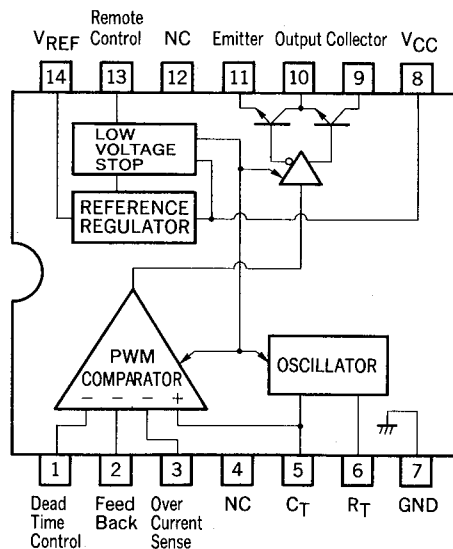

ABSOLUTE MAXIMUM RATINGS (T_a = 25 °C)

Supply Voltage	V _{CC}	26	V
Output Voltage	V _C	26	V
Output Current (DC)	I _{C(DC)}	100	mA
Output Current (Peak)	I _{C(peak)}	1.2	A
Total Power Dissipation	μPC1094C	P _T	570 mW
	μPC1094G	P _T	550 mW
Operating Temperature Range	T _{opt}	-20 to +85	°C
Storage Temperature Range	T _{stg}	-55 to +150	°C

RECOMMENDED OPERATING CONDITIONS

CHARACTERISTIC	SYMBOL	MIN.	TYP.	MAX.	UNIT
Supply Voltage	V _{CC}	11	15	24	V
Oscillation Frequency	f _{osc}	50	200	500	kHz
Output Load Capacitance	C _L		2 200	3 000	pF

OPERATING WAVEFORM

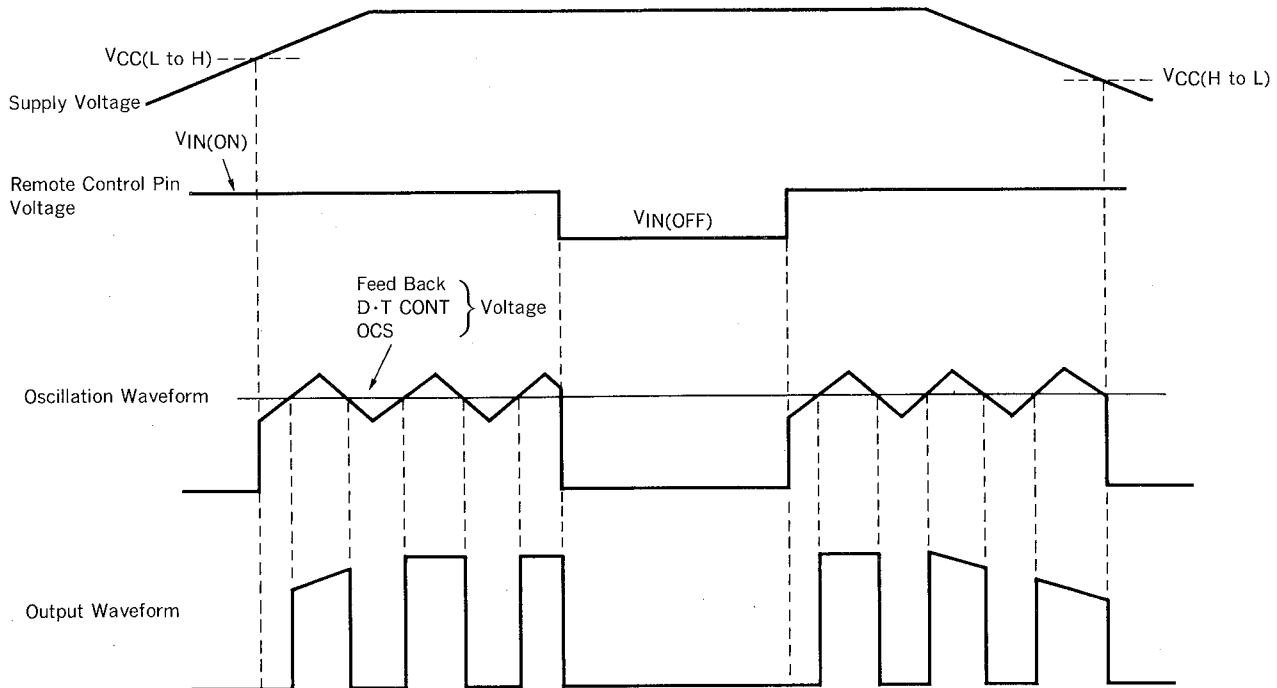

ELECTRICAL CHARACTERISTICS ($T_a = 25\text{ }^\circ\text{C}$, $V_{CC} = 15\text{ V}$, $R_T = 36\text{ k}\Omega$, $C_T = 1\text{ 000 pF}$, $f_{osc} = 200\text{ kHz}$)

BLOCK	CHARACTERISTIC	SYMBOL	MIN.	TYP.	MAX.	UNIT	TEST CONDITIONS
	Stand-by Current	$I_{CC(SB)}$		0.9	1.6	mA	$V_{CC} = 8\text{ V}$, $-10\text{ }^\circ\text{C} \leq T_a \leq +85\text{ }^\circ\text{C}$
	Circuit Current	I_{CC}		6	10	mA	$V_{CC} = V_C = 20\text{ V}$, $V_D = 2.15\text{ V}$ No Load *1
Low Voltage Stop Circuit	Start-up Voltage	$V_{CC(LtoH)}$	9.6	10.3	11	V	
	Hysteresis Voltage	V_H	1.8	2.0	2.2	V	
Reference Voltage Circuit	Reference Voltage	V_{REF}	4.75	5.0	5.25	V	$I_{REF} = 0$
	Line Regulation	REG_{IN}		1	10	mV	$11\text{ V} \leq V_{CC} \leq 20\text{ V}$, $I_{REF} = 0$
	Load Regulation	REG_L		6.5	12	mV	$0 \leq I_{REF} \leq 3\text{ mA}$
	Temperature Coefficient	$\Delta V_{REF}/\Delta T$		400	700	$\mu\text{V}/^\circ\text{C}$	$I_{REF} = 0$, $-10\text{ }^\circ\text{C} \leq T_a \leq +85\text{ }^\circ\text{C}$
	Short Circuit Current	I_{short}		13		mA	$V_{REF} = 0$
PWM Circuit	Input Bias Current	I_B			10	μA	
	Low Level Threshold Voltage	$V_{TH(L)}$		1.6		V	
	High Level Threshold Voltage	$V_{TH(H)}$		2.5		V	
	Dead Time Temperature Coefficient			3		%	$V_D = 0.43 V_{REF}$, $-10\text{ }^\circ\text{C} \leq T_a \leq +85\text{ }^\circ\text{C}$
Oscillator Circuit	Oscillation Frequency	f_{osc}	180	200	220	kHz	
	Frequency Line Regulation	$\Delta f/\Delta V$		1		%	$11\text{ V} \leq V_{CC} \leq 20\text{ V}$
	Frequency Temperature Coefficient	$\Delta f/\Delta T$		2	5	%	$-10\text{ }^\circ\text{C} \leq T_a \leq +85\text{ }^\circ\text{C}$
Output Circuit	Low Level Output Voltage	V_{OL}			0.5	V	$I_{SINK} = 3\text{ mA}$ *1
	High Level Output Voltage	V_{OH}		$V_{CC}-1.6$		V	$I_{SOURCE} = 30\text{ mA}$ *1
	Output Voltage Rise Time	t_r		60		ns	$R_L = 15\text{ }\Omega$, $C_L = 2\text{ 200 pF}$ *1, *2
	Output Voltage Fall Time	t_f		40		ns	
Remote Control Circuit	Input Voltage (ON)	$V_{IN(ON)}$			2.4	V	
	Input Voltage (OFF)	$V_{IN(OFF)}$	0.5			V	

*1 V_{CC} – Collector (pin 9) connection, GND – Emitter (pin 11) connection

*2 R_L : Load Resistance C_L : Load Capacitance

TYPICAL CHARACTERISTICS ($T_a = 25^\circ\text{C}$, $V_{CC} = 15\text{V}$)

MAXIMUM POWER DISSIPATION vs. AMBIENT TEMPERATURE

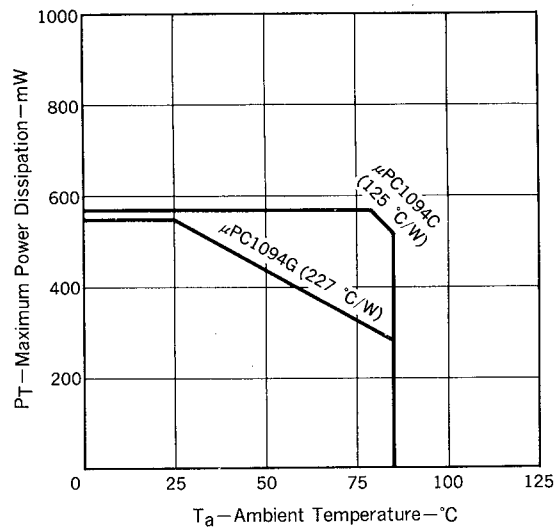

LOW VOLTAGE STOP CIRCUIT

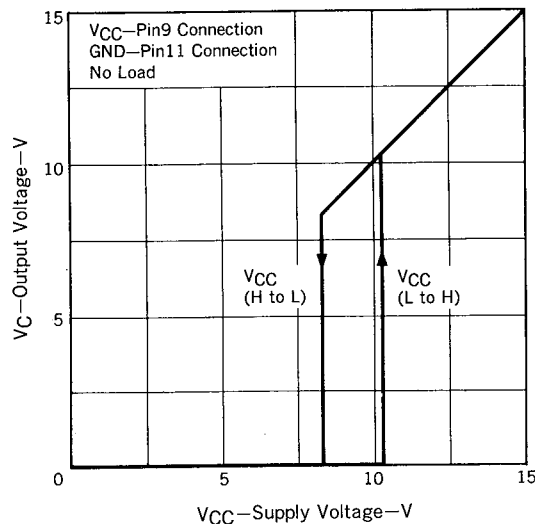

STAND-BY CURRENT vs. AMBIENT TEMPERATURE

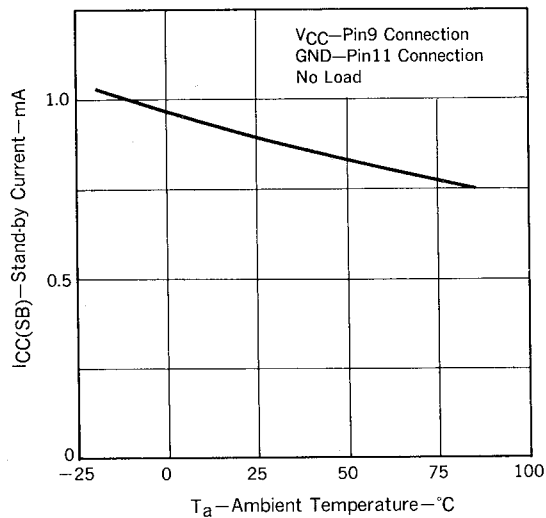

CIRCUIT CURRENT vs. SUPPLY VOLTAGE

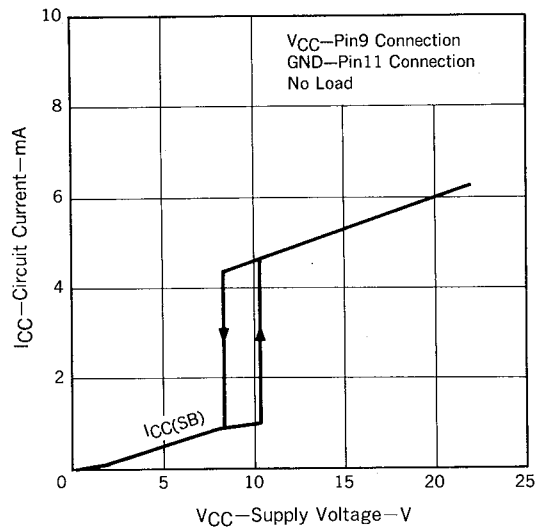

REFERENCE VOLTAGE DEVIATION vs. AMBIENT TEMPERATURE

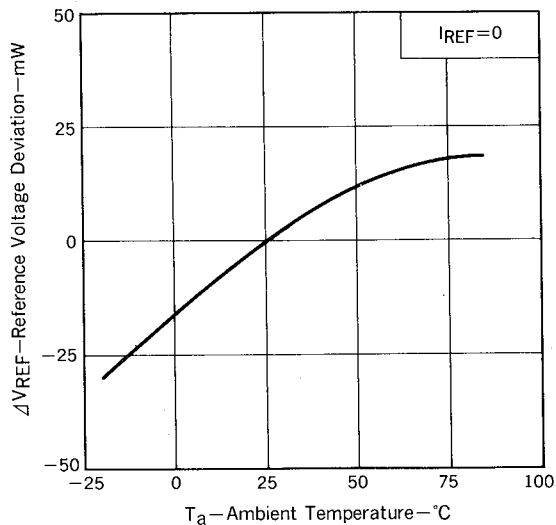

OSCILLATION FREQUENCY vs. TIMING RESISTANCE, CAPACITANCE

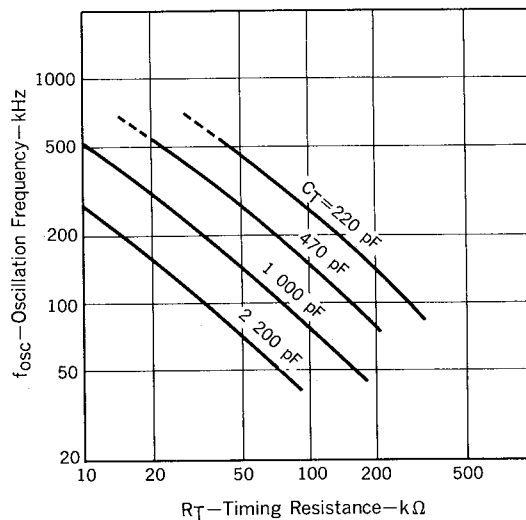

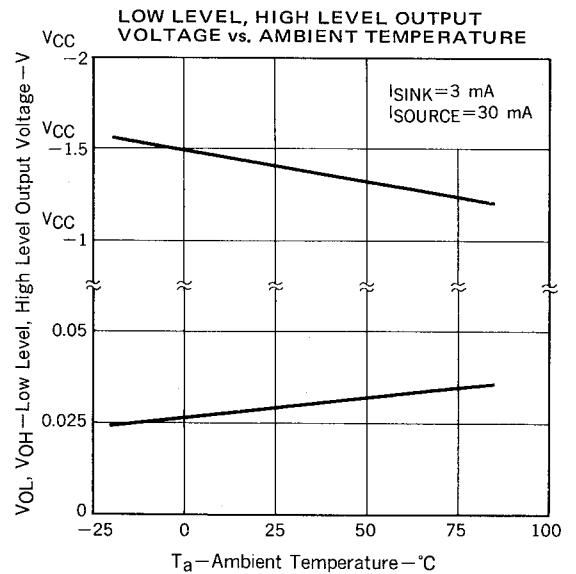
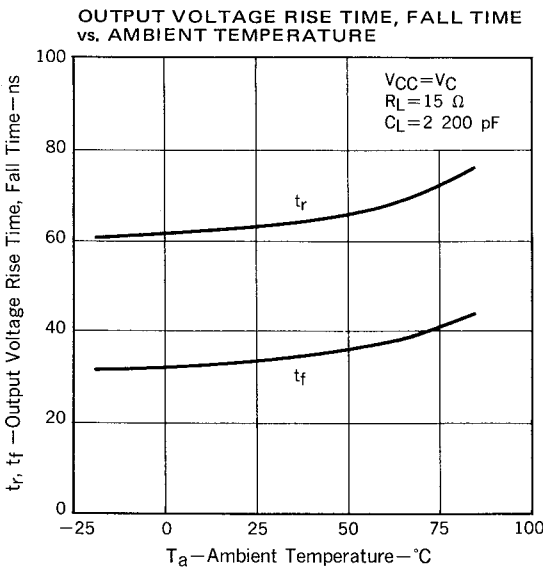
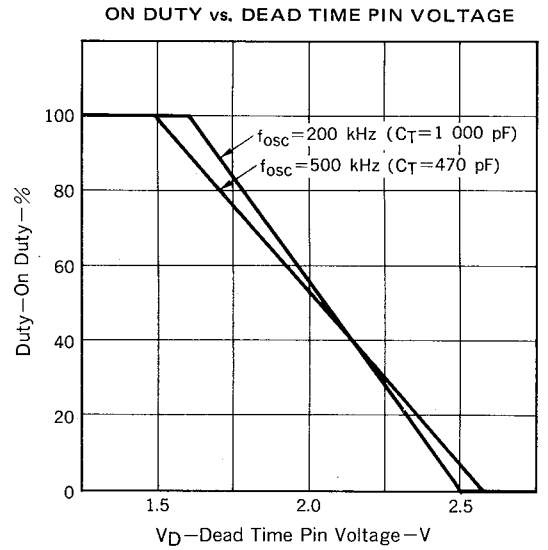
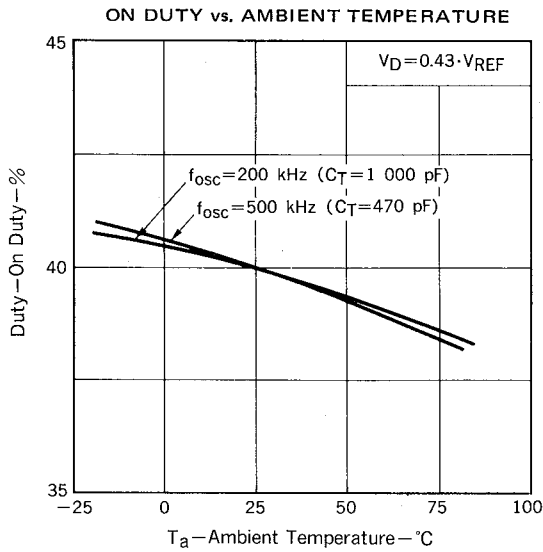
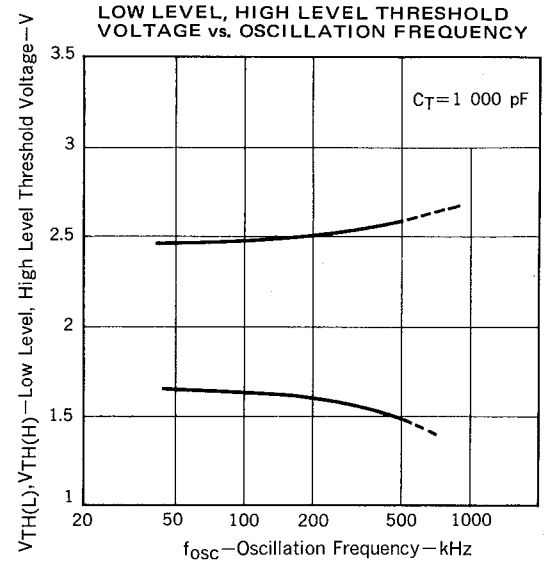
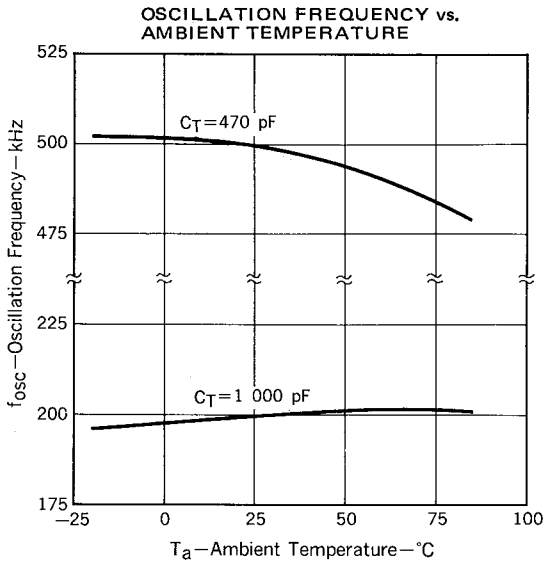

14-Pin Plastic DIP (300 mil)

(C Package)

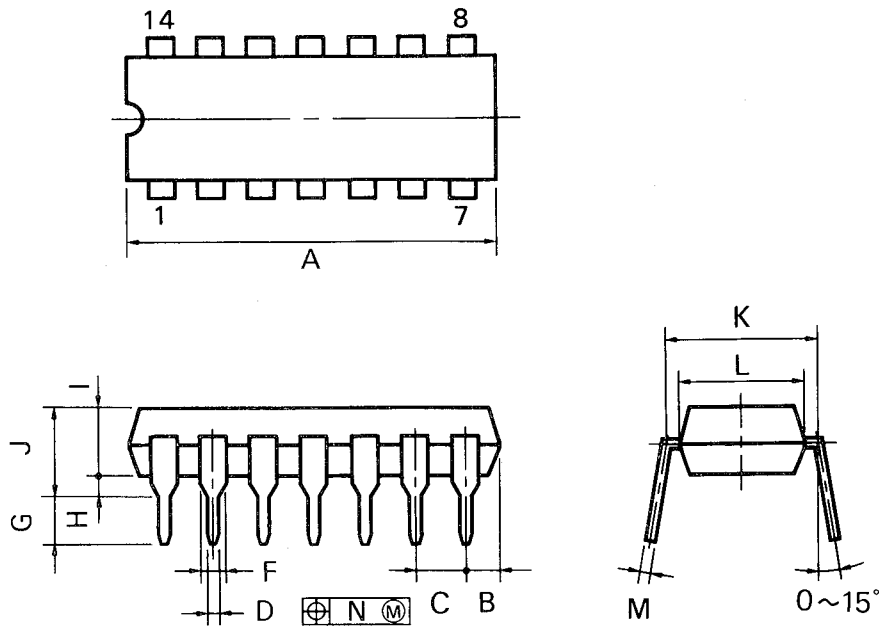

P14C-100-300B1

NOTES

- 1) Each lead centerline is located within 0.25 mm (0.01 inch) of its true position (T.P.) at maximum material condition.
- 2) Item "K" to center of leads when formed parallel.

ITEM	MILLIMETERS	INCHES
A	20.32 MAX.	0.800 MAX.
B	2.54 MAX.	0.100 MAX.
C	2.54 (T.P.)	0.100 (T.P.)
D	0.50 ^{+0.10}	0.020 ^{+0.004} _{-0.005}
F	1.2 MIN.	0.047 MIN.
G	3.6 ^{±0.3}	0.142 ^{±0.012}
H	0.51 MIN.	0.020 MIN.
I	4.31 MAX.	0.170 MAX.
J	5.08 MAX.	0.200 MAX.
K	7.62 (T.P.)	0.300 (T.P.)
L	6.4	0.252
M	0.25 ^{+0.10} _{-0.05}	0.010 ^{+0.004} _{-0.003}
N	0.25	0.01

14-Pin Plastic SOP (225 mil)
(G Package)

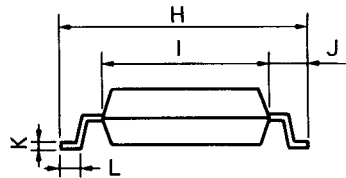
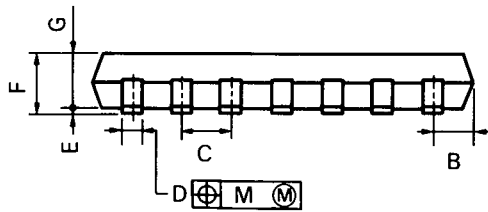
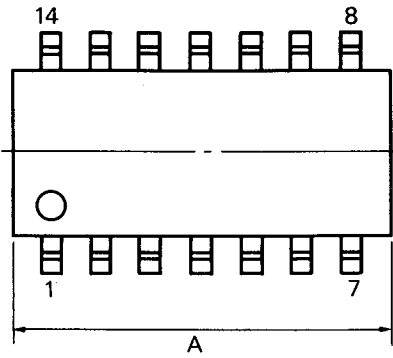

S14GM-50-225B, C

NOTE

Each lead centerline is located within 0.12 mm (0.005 inch) of its true position (T.P.) at maximum material condition.

ITEM	MILLIMETERS	INCHES
A	10.46 MAX.	0.412 MAX.
B	1.42 MAX.	0.056 MAX.
C	1.27 (T.P.)	0.050 (T.P.)
D	0.40 ^{+0.10} _{-0.05}	0.016 ^{+0.004} _{-0.003}
E	0.1 ^{±0.1}	0.004 ^{±0.004}
F	1.8 MAX.	0.071 MAX.
G	1.49	0.059
H	6.5 ^{±0.3}	0.256 ^{±0.012}
I	4.4	0.173
J	1.1	0.043
K	0.15 ^{+0.10} _{-0.05}	0.006 ^{+0.004} _{-0.002}
L	0.6 ^{±0.2}	0.024 ^{+0.008} _{-0.008}
M	0.12	0.005