



# BIPOLAR ANALOG INTEGRATED CIRCUIT

## µPC1215V

### ELECTRONIC TUNING AM RADIO RECEIVER SILICON BIPOLAR MONOLITHIC INTEGRATED CIRCUIT

#### DESCRIPTION

The µPC1215V is a monolithic integrated circuit that is provided with the mixer, low level oscillator, IF amplifier, detector and station detector for an electronic tuning AM radio receiver.

This IC also contains internal AGC for the first IF amplifier stage, delayed AGC for an optional external RF amplifier and oscillator buffer amplifier to drive a logic section.

The µPC1215V is suitable for use in automotive radio receivers, specially where compact mounting is required, such as car stereo sets, because its package is the 19-leads vertical dual in-line plastic package (V-DIP).

#### FEATURES

- High sensitivity and wide AGC range.
- Excellent overload characteristics.
- Delayed AGC for RF amplifier.
- Special low level oscillator to reduce tracking error.
- Oscillator buffer output.
- Station detector for auto scan stop.
- Occupation of minimum area in P.C. Board.

#### PACKAGE DIMENSIONS (in millimeters)

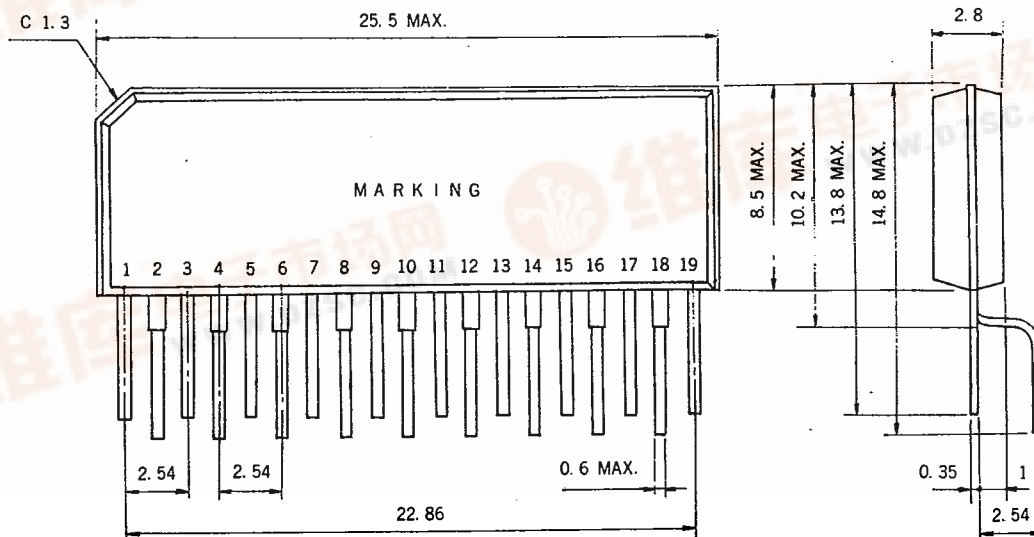

**BLOCK DIAGRAM**

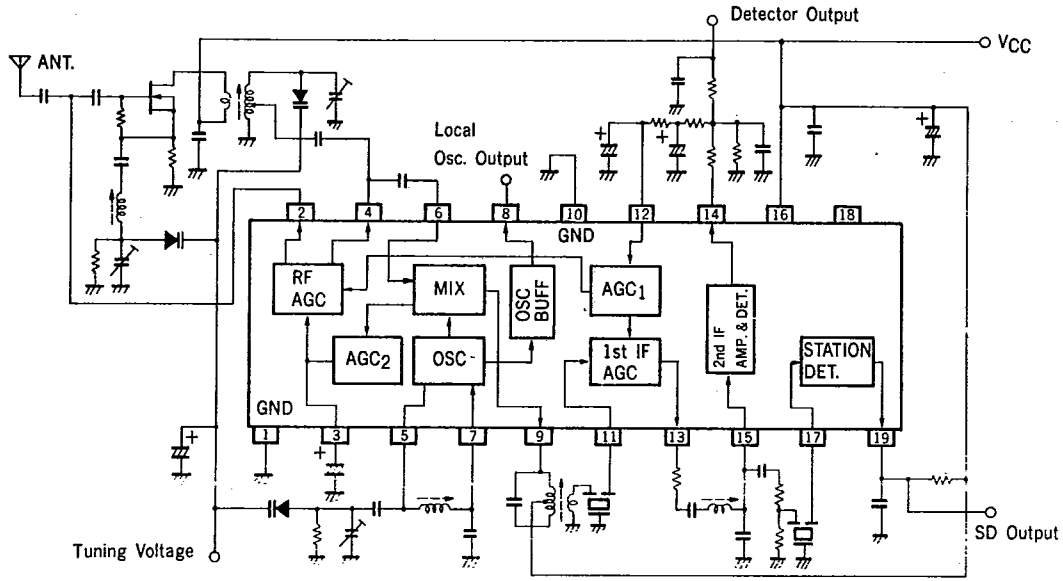

**CONNECTION DIAGRAM**

Pin No.	Connection	Pin No.	Connection
1	GND <sub>1</sub>	2	AGC for Antenna
3	AGC Filter	4	AGC for RF
5	OSC Tank	6	MIX Input
7	OSC Bypass	8	OSC Buffer Output
9	MIX Output	10	GND <sub>2</sub>
11	1st IF Amp. Input	12	AGC Input
13	1st IF Amp. Output	14	Detector Output
15	2nd. IF Amp. Input	16	V <sub>CC</sub>
17	Station Det. Input	18	
19	Station Det. Output		

**EQUIVALENT CIRCUIT**

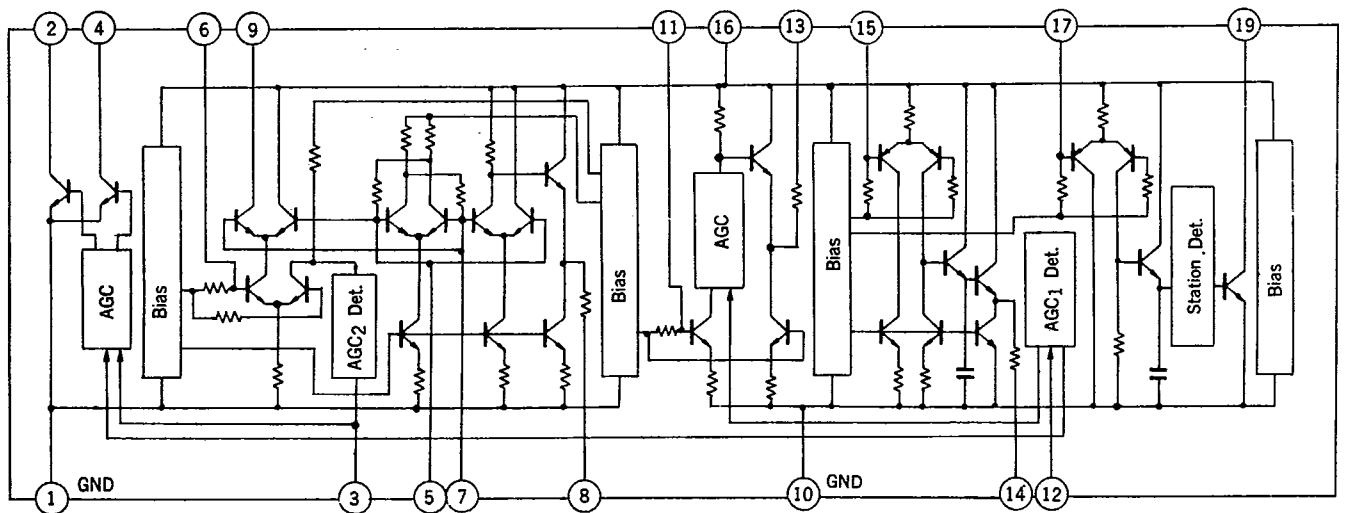

**ABSOLUTE MAXIMUM RATINGS (Ta = 25 °C)**

DC Supply Voltage	V <sub>CC</sub>	15	V
Input Voltage	V <sub>i</sub>	3.0	V <sub>p-p</sub>
Package Dissipation	P <sub>d</sub>	430 (Ta = 75 °C)	mW
Operating Temperature	T <sub>opt</sub>	-30 to +75	°C
Storage Temperature	T <sub>stg</sub>	-40 to +125	°C

**RECOMENDED OPERATING CONDITIONS**

DC Supply Voltage Range	V <sub>CC</sub>	8.0 to 15	V
Operating Ambient Temperature	Ta	-30 to +75	°C

**ELECTRICAL CHARACTERISTICS (Ta = 25 °C, V<sub>CC</sub> = 10 V, f = 1.0 MHz, f<sub>mod.</sub> = 400 Hz, mod. = 30 %)**

CHARACTERISTIC	SYMBOL	MIN.	TYP.	MAX.	UNIT	TEST CONDITION
Circuit Current	I <sub>CC</sub>	10	14	21	mA	At no signal
Maximum Sensitivity	MS	14	21	28	dBμV	v <sub>o</sub> = 30 mVr.m.s.
Signal to Noise Ratio	S/N	8.0	13		dB	v <sub>i</sub> = 21 dBμV
Detector Output Volt.*	v <sub>o</sub>	70	100	130	mVr.m.s.	v <sub>i</sub> = 74 dBμV
Harmonic Distortion	T.H.D.		0.5	1.0	%	v <sub>i</sub> = 120 dBμV
SD Output Voltage	VSD-L			0.5	V	v <sub>i</sub> = 0 dBμV
	VSD-H	8.0			V	v <sub>i</sub> = 74 dBμV

\* Detector output voltage is classified into four ranks (D,E,F and H) which have different resistor R<sub>g</sub> connected to pin-14.

**TUNER PERFORMANCE CHARACTERISTICS**

(Ta = 25 °C, V<sub>CC</sub> = 10 V, f = 1.0 MHz, f<sub>mod.</sub> = 400 Hz, mod. = 30 %)

CHARACTERISTIC	TEST CONDITION	VALUE	UNIT
Maximum Sensitivity	v <sub>o</sub> = 30 mVr.m.s.	22	dBμV
Usable Sensitivity	S/N = 20 dB	28	dBμV
Detector Output Voltage	v <sub>i</sub> = 74 dBμV	100	mVr.m.s.
Total Harmonic Distortion	v <sub>i</sub> = 74 dBμV	0.3	%
	v <sub>i</sub> = 126 dBμV	0.6	%
	v <sub>i</sub> = 74 dBμV, mod. = 80 %	1.2	%
Signal to Noise Ratio	v <sub>i</sub> = 74 dBμV	52	dB
IF Rejection Ratio	v <sub>o</sub> = 30 mVr.m.s., IF = 450 kHz	56	dB
Image Rejection Ratio	v <sub>o</sub> = 30 mVr.m.s., f+2 IF	57	dB
Selectivity	Δf = ±10 kHz	39	dB
Tweet	v <sub>i</sub> = 74 dBμV, 2 IF = 900 kHz	40	dB
	v <sub>i</sub> = 74 dBμV, 3 IF = 1 350 kHz	47	dB
DX Sensitivity	V19 = 8.0 V	26	dBμV
SD Bandwidth	v <sub>i</sub> = 74 dBμV, V <sub>SD</sub> = 7 V	5.0	kHz
Oscillation Voltage	At terminal 5	150	mVr.m.s.
	At terminal 8	4.0	V <sub>p-p</sub>



**COIL DATA**

**L1 & L2 : Ant. & RF Coil**

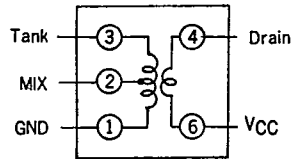

**TYPE 7BR-5407N (Toko Inc.)**

Qu=80 min., L=170 μH  
 ①-②, ②-③, ④-⑥  
 7T 62T 14T

**L3 : OSC Coil**

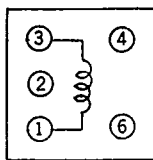

**TYPE 7BR-6048Z (Toko Inc.)**

Qu=60 min., L=95 μH  
 ①-③  
 48T

**IFT1 : IFT**

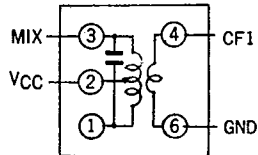

**TYPE 7MC-4718N (Toko Inc.)**

Qu=115±20 %, C=180 pF built in  
 ①-②, ②-③, ④-⑥  
 69T 77T 14T

**IFT2 : IFT**

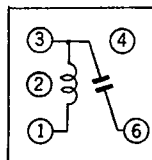

**TYPE 7MC-101000CO (Toko Inc.)**

L=680 μH, C=180 pF built in

**CERAMIC FILTER (Toko Inc.)**

	CFM2-450BL	CFM2-450ZL
Center Frequency	450 kHz	450 kHz
6 dB Bandwidth	6 kHz min.	4 kHz min.
Selectivity ±9 kHz	16 dB min.	18 dB min.
Insertion Loss	6 dB max.	6 dB max.
Input Impedance	1.5 kΩ	1.0 kΩ
Output Impedance	2.0 kΩ	1.5 kΩ

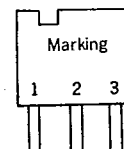

1 : Input  
 2 : GND  
 3 : Output



TYPICAL CHARACTERISTICS (Ta = 25 °C)

DETECTOR OUTPUT CHARACTERISTICS

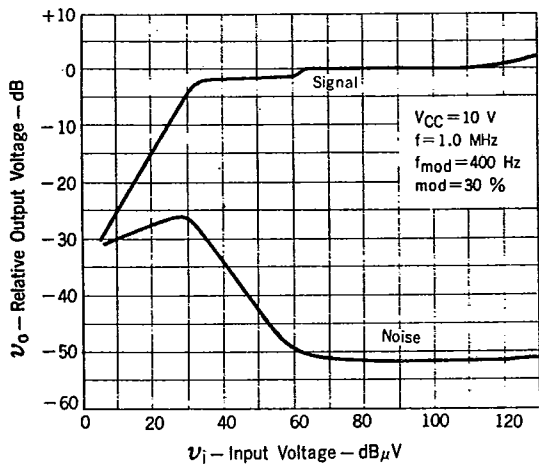

SIGNAL-TO-NOISE RATIO

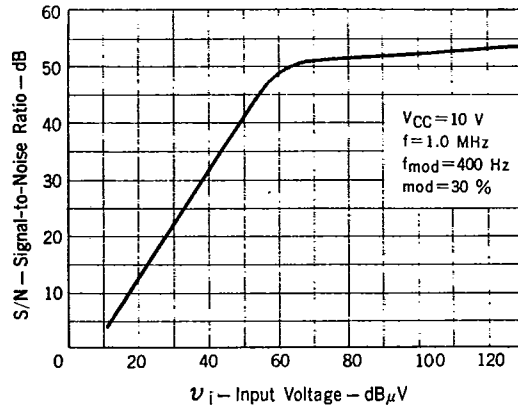

TOTAL HARMONIC DISTORTION vs. INPUT VOLTAGE

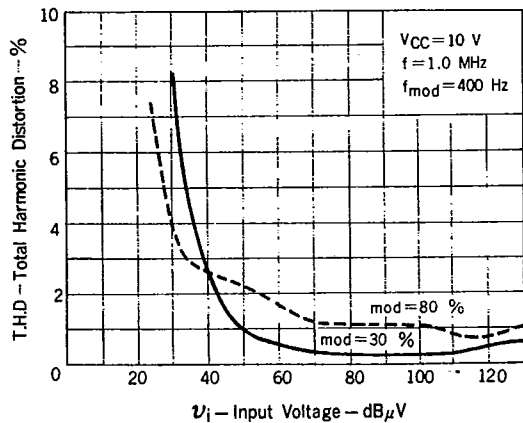

OUTPUT VOLTAGE AND TOTAL HARMONIC DISTORTION vs. MODULATION

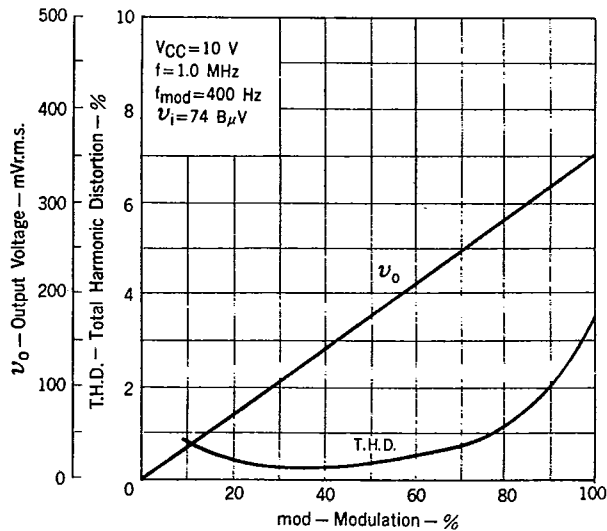

ELECTRICAL FIDELITY

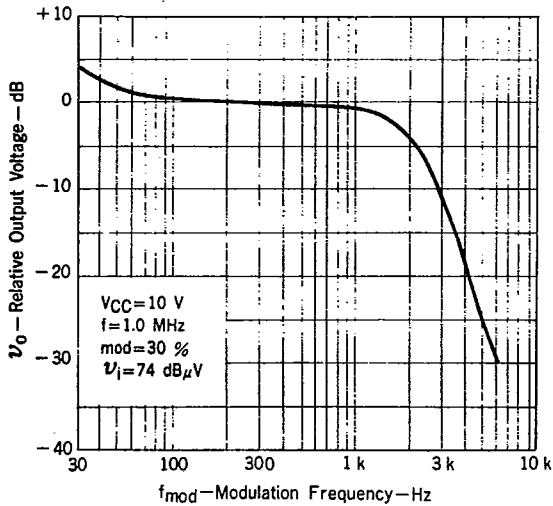

TOTAL HARMONIC DISTORTION vs. MODULATION FREQUENCY

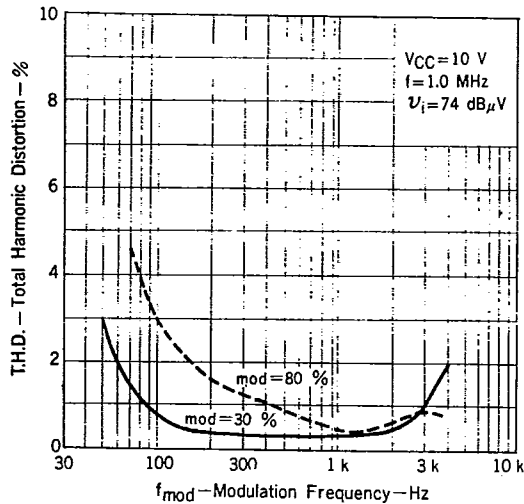

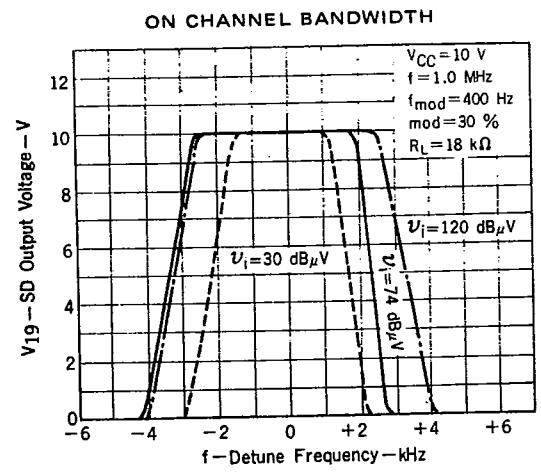
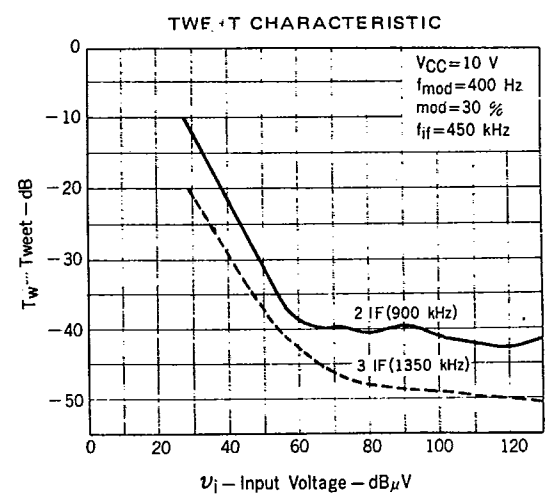
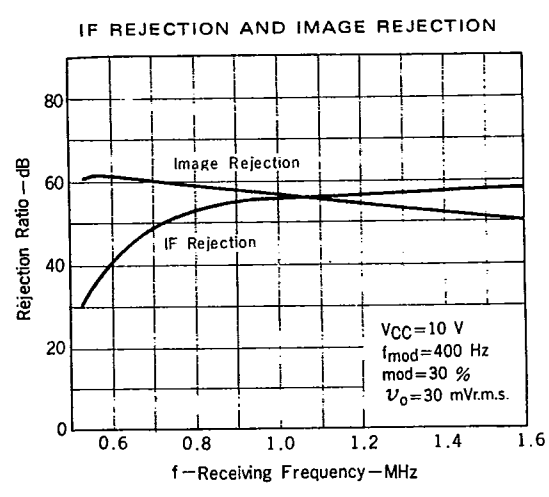
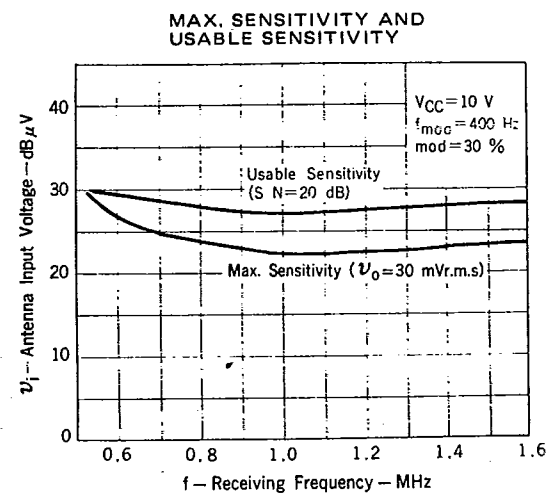
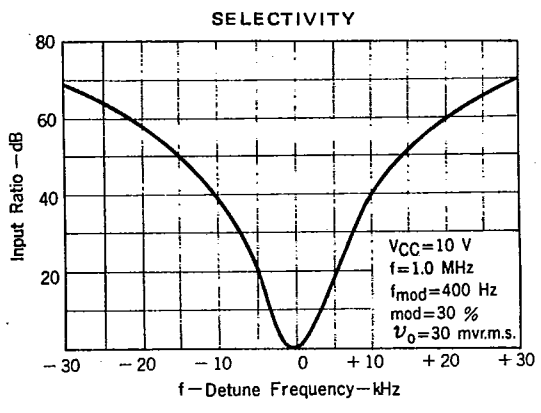



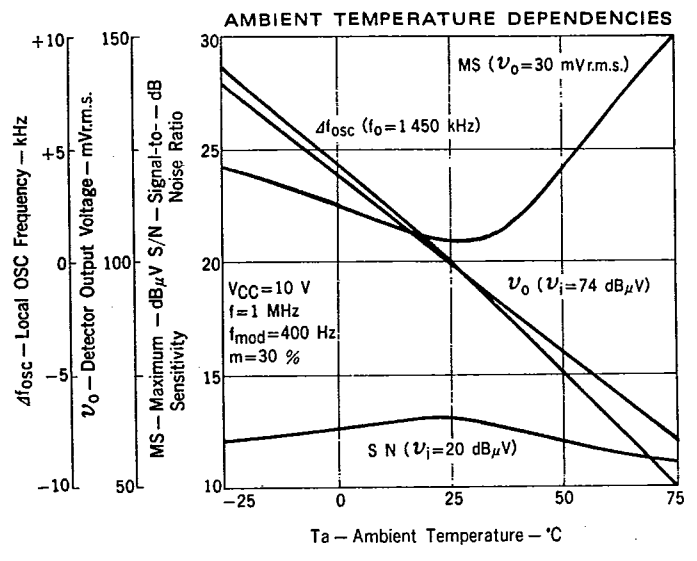
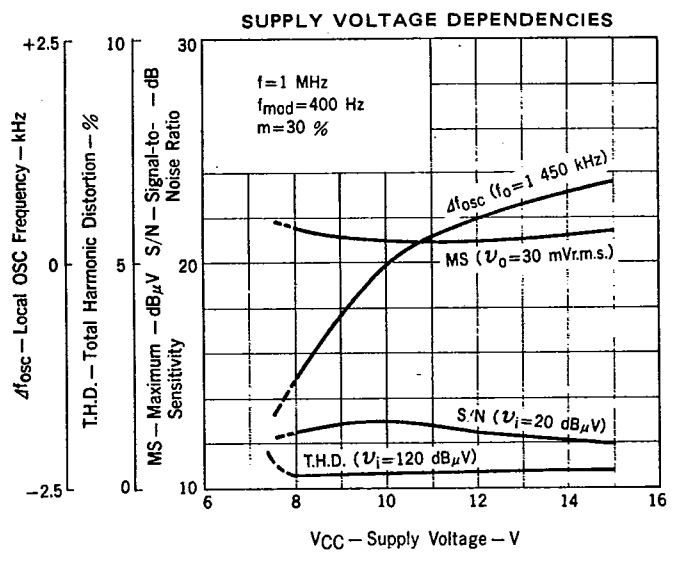

Note: Only IC without peripheral components is heated and cooled.

COMPONENTS LAYOUT FOR P.C.ASSEMBLY (Copper side)

