



V385

8-BIT LVDS TRANSMITTER FOR VIDEO

General Description

The V385 transmitter converts 28 bits of 3.3 V CMOS/TTL into 4 Low Voltage Differential Signaling (LVDS) data streams while the transmit clock input is transmitted in parallel with the data streams over a fifth LVDS link. The V385 can be programmed for rising edge or falling edge clocks through pin R_FB.

ICS manufactures a large variety of video application devices. Consult ICS for all of your video application requirements.

Pin Assignment

VCC	1	56	TxIN4
TxIN5	2	55	TxIN3
TxIN6	3	54	TxIN2
TxIN7	4	53	GND
GND	5	52	TxIN1
TxIN8	6	51	TxIN0
TxIN9	7	50	TxIN27
TxIN10	8	49	LVDS_GND
VCC	9	48	TxOUT0-
TxIN11	10	47	TxOUT0+
TxIN12	11	46	TxOUT1-
TxIN13	12	45	TxOUT1+
GND	13	44	LVDS_VCC
TxIN14	14	43	LVDS_GND
TxIN15	15	42	TxOUT2-
TxIN16	16	41	TxOUT2+
R_FB	17	40	TxCLKOUT-
TxIN17	18	39	TxCLKOUT+
TxIN18	19	38	TxOUT3-
TxIN19	20	37	TxOUT3+
GND	21	36	LVDS_GND
TxIN20	22	35	PLL_GND
TxIN21	23	34	PLL_VCC
TxIN22	24	33	PLL_GND
TxIN23	25	32	PWRDWN
VCC	26	31	TxCLKIN
TxIN24	27	30	TxIN26
TxIN25	28	29	GND

56-pin TSSOP

Features

- Pin and function compatible with the National DS90C385, TI SN65LVDS93 and Thine THC63LVDM83
- Convert 28 bits of 3.3 V CMOS/TTL into 4 LVDS streams
- Up to 2.38 Gbps throughput or 297.5 Megabytes/sec bandwidth
- Wide clock frequency range from 20 MHz to 85 MHz
- Spread spectrum compatible
- Supports VGA, SVGA, XGA, and SXGA
- LVDS voltage swing of 350 mV for low EMI
- On-chip PLL requires no external components
- Single 3.3 V low-power CMOS design
- Programmable rising or falling edge strobe
- Power-down control function
- Compatible with TIA/EIA-644 LVDS standards
- Packaged in a 56-pin TSSOP (Pb free available)

Block Diagram

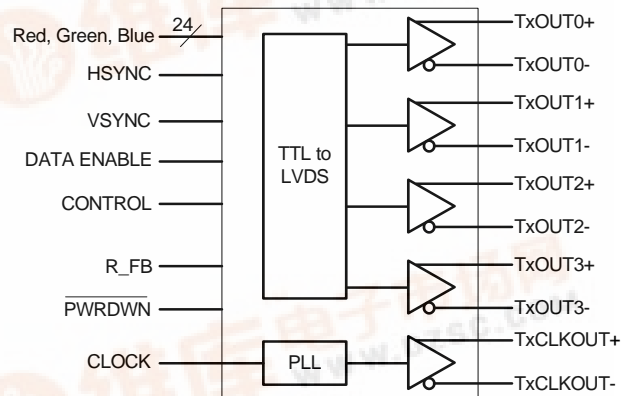

**V385****8-BIT LVDS TRANSMITTER FOR VIDEO**

Pin Descriptions

Pin	Pin Type	Pin Name	Pin Description/Name
1	Power	VCC	3.3V Power
2	CMOS/TTL	TxIN5	Parallel digital video input pins (TxIN0..27).
3	CMOS/TTL	TxIN6	Parallel digital video input pins (TxIN0..27).
4	CMOS/TTL	TxIN7	Parallel digital video input pins (TxIN0..27).
5	Ground	GND	Ground
6	CMOS/TTL	TxIN8	Parallel digital video input pins (TxIN0..27).
7	CMOS/TTL	TxIN9	Parallel digital video input pins (TxIN0..27).
8	CMOS/TTL	TxIN10	Parallel digital video input pins (TxIN0..27).
9	Power	VCC	3.3V Power
10	CMOS/TTL	TxIN11	Parallel digital video input pins (TxIN0..27).
11	CMOS/TTL	TxIN12	Parallel digital video input pins (TxIN0..27).
12	CMOS/TTL	TxIN13	Parallel digital video input pins (TxIN0..27).
13	Ground	GND	Ground
14	CMOS/TTL	TxIN14	Parallel digital video input pins (TxIN0..27).
15	CMOS/TTL	TxIN15	Parallel digital video input pins (TxIN0..27).
16	CMOS/TTL	TxIN16	Parallel digital video input pins (TxIN0..27).
17	CMOS/TTL	R_FB	Programmable strobe select input pin (R_FB). High = rising edge; Low = falling edge.
18	CMOS/TTL	TxIN17	Parallel digital video input pins (TxIN0..27).
19	CMOS/TTL	TxIN18	Parallel digital video input pins (TxIN0..27).
20	CMOS/TTL	TxIN19	Parallel digital video input pins (TxIN0..27).
21	Ground	GND	Ground
22	CMOS/TTL	TxIN20	Parallel digital video input pins (TxIN0..27).
23	CMOS/TTL	TxIN21	Parallel digital video input pins (TxIN0..27).
24	CMOS/TTL	TxIN22	Parallel digital video input pins (TxIN0..27).
25	CMOS/TTL	TxIN23	Parallel digital video input pins (TxIN0..27).
26	Power	VCC	3.3V Power
27	CMOS/TTL	TxIN24	Parallel digital video input pins (TxIN0..27).
28	CMOS/TTL	TxIN25	Parallel digital video input pins (TxIN0..27).
29	Ground	GND	Ground
30	CMOS/TTL	TxIN26	Parallel digital video input pins (TxIN0..27).
31	CMOS/TTL	TxCLKIN	Clock input (TxCLKIN)
32	CMOS/TTL	$\overline{\text{PWRDWN}}$	Active low. Powerdown tri-states outputs.
33	Ground	PLL_GND	Ground
34	Power	PLL_VCC	3.3V Power
35	Ground	PLL_GND	Ground
36	Ground	LVDS_GND	Ground





V385

8-BIT LVDS TRANSMITTER FOR VIDEO

Pin	Pin Type	Pin Name	Pin Description/Name
37	LVDS	TxOUT3+	LVDS output (+)
38	LVDS	TxOUT3-	LVDS output (-)
39	LVDS	TxCLKOUT+	LVDS output (+)
40	LVDS	TxCLKOUT-	LVDS output (-)
41	LVDS	TxOUT2+	LVDS output (+)
42	LVDS	TxOUT2-	LVDS output (-)
43	Ground	LVDS_GND	Ground
44	Power	LVDS_VCC	3.3V Power
45	LVDS	TxOUT1+	LVDS output (+)
46	LVDS	TxOUT1-	LVDS output (-)
47	LVDS	TxOUT0+	LVDS output (+)
48	LVDS	TxOUT0-	LVDS output (-)
49	Ground	LVDS_GND	Ground
50	CMOS/TTL	TxIN27	Parallel digital video input pins (TxIN0..27).
51	CMOS/TTL	TxIn0	Parallel digital video input pins (TxIN0..27).
52	CMOS/TTL	TxIn1	Parallel digital video input pins (TxIN0..27).
53	Ground	GND	Ground
54	CMOS/TTL	TxIn2	Parallel digital video input pins (TxIN0..27).
55	CMOS/TTL	TxIn3	Parallel digital video input pins (TxIN0..27).
56	CMOS/TTL	TxIn4	Parallel digital video input pins (TxIN0..27).

External Components

The V385 requires no external components.



**V385****8-BIT LVDS TRANSMITTER FOR VIDEO**

Absolute Maximum Ratings

Stresses above the ratings listed below can cause permanent damage to the V385. These ratings, which are standard values for ICS commercially rated parts, are stress ratings only. Functional operation of the device at these or any other conditions above those indicated in the operational sections of the specifications is not implied. Exposure to absolute maximum rating conditions for extended periods can affect product reliability. Electrical parameters are guaranteed only over the recommended operating temperature range.

Item	Rating
Supply Voltage, VDD	-0.3 V to +4 V
All Inputs and Outputs	-0.3 V to VCC+0.3 V
Electrostatic Discharge (EIAJ, 0Ω, 200 pF)	> 500 V
Ambient Operating Temperature	0 to +70°C
Storage Temperature	-65 to +150°C
Junction Temperature	150°C
Maximum Soldering Temperature	260°C

Recommended Operation Conditions

Parameter	Min.	Typ.	Max.	Units
Ambient Operating Temperature	0		+70	°C
Power Supply Voltage (measured in respect to GND)	3.0	3.3	3.6	V

Electrical Characteristics

VDD=3.3 V ±10%, Ambient temperature 0 to +70°C

Parameter	Symbol	Conditions	Min.	Typ.	Max.	Units	Freq.
CMOS/TTL DC Specifications							
Input High Voltage	V _{IH}		2.00		VCC	V	
Input Low Voltage	V _{IL}		GND		0.80	V	
Input Current	I _{IN}	GND<VIN<VCC			±10	μA	
Power-down Current	I _{PD}	No switching for input pins			10	μA	
LVDS DC Specifications							
Differential Output Voltage	V _{OD}	R _L = 100 ohms	250	345	450	mV	
Change in V _{OD} Between Complimentary Output States	ΔV _{OD}				35	mV	
Common Mode Voltage	V _{CM}		1.125	1.250	1.375	V	
Change in V _{CM} Between Complimentary Output States	ΔV _{CM}				35	mV	
Output Short Circuit Current	I _{OS}	V _{OD} =0V		3.5	5	mA	
Output Tri-State Current	I _{OZ}	Power Down#=0V		±1	±10	μA	





V385

8-BIT LVDS TRANSMITTER FOR VIDEO

Parameter	Symbol	Conditions	Min.	Typ.	Max.	Units	Freq.
Recommended Transmitter Input Characteristics							
TxCLK IN Transition Time	TCIT				5	ns	
TxCLK IN Period	TCIP		11.76	T	50	ns	
TxCLK IN High Time	TCIH		0.35T	0.5T	0.65T	ns	
TxCLK IN Low Time	TCIL		0.35T	0.5T	0.65T	ns	
TxIN Transition Time	TXIT		1.5		6	ns	
Transmitter Switching Characteristics							
LVDS Low-to-High Time	LLHT			0.75	1.4	ns	
LVDS High-to-Low Time	LHLT			0.75	1.4	ns	
Transmitter Output Pulse Position	TPPos0	Bit0	-0.2	0	0.2	0.2	85 MHz
	TPPos1	Bit1	T/7-0.2	T/7	T/7+0.2	ns	85 MHz
	TPPos2	Bit2	2T/7-0.2	2T/7	2T/7+0.2	ns	85 MHz
	TPPos3	Bit3	3T/7-0.2	3T/7	3T/7+0.2	ns	85 MHz
	TPPos4	Bit4	4T/7-0.2	4T/7	4T/7+0.2	ns	85 MHz
	TPPos5	Bit5	5T/7-0.2	5T/7	5T/7+0.2	ns	85 MHz
	TPPos6	Bit6	6T/7-0.2	6T/7	6T/7+0.2	ns	85 MHz
Transmitter Phase Loop Set	TPLLS				10	ms	
TxIN Setup to TxCLK IN	TSTC		2.5			ns	
TxIN Hold to TxCLK IN	THTC		0			ns	
TxCLK IN to TxCLK OUT Delay	TCCD		10		30	ns	

Thermal Characteristics

Parameter	Symbol	Conditions	Min.	Typ.	Max.	Units
Thermal Resistance Junction to Ambient	θ_{JA}	Still air		84		°C/W
	θ_{JA}	1 m/s air flow		76		°C/W
	θ_{JA}	3 m/s air flow		67		°C/W
Thermal Resistance Junction to Case	θ_{JC}			50		°C/W





AC Timing Diagrams

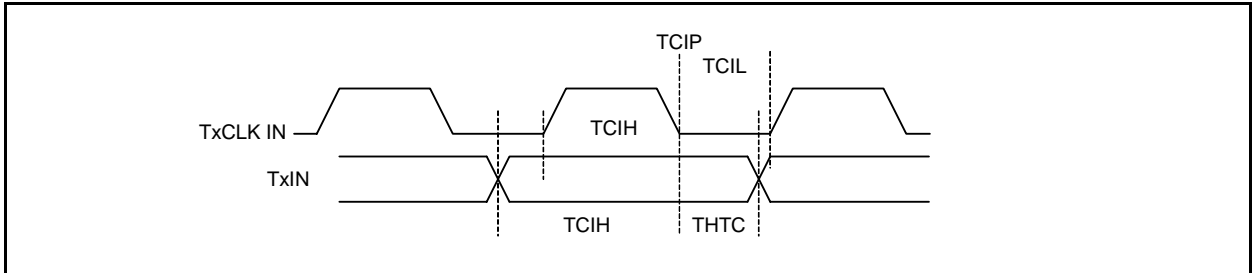

Figure AC1. Transmitter Setup/Hold and High/Low Times (Falling Edge Strobe or R_FB=0)

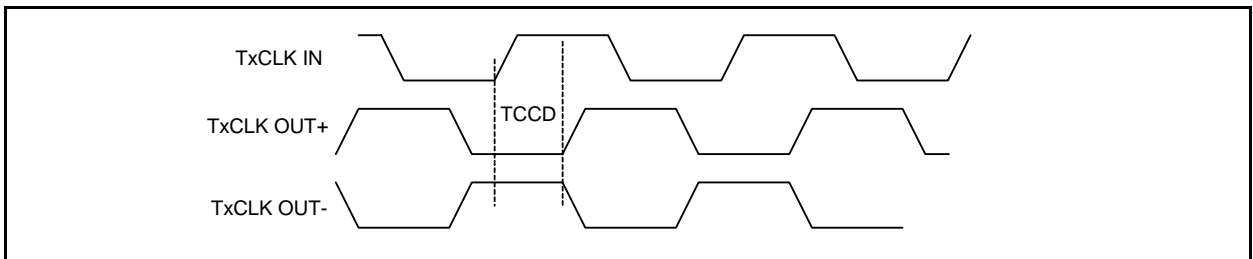

Figure AC2. Clock IN to Clock OUT Delay (Rising Edge Strobe or R_FB=1)

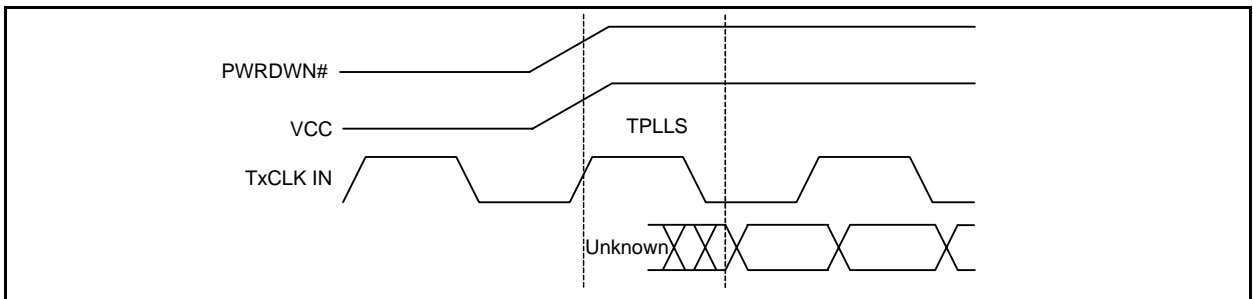

Figure AC3. Phase Lock Loop Set Time





V385 8-BIT LVDS TRANSMITTER FOR VIDEO

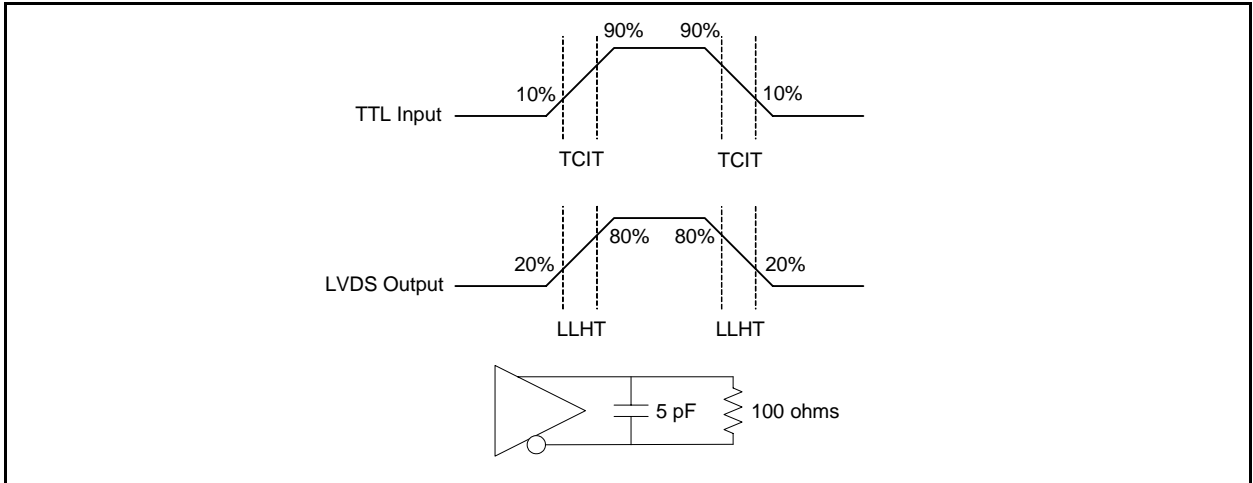

Figure AC4. Transmitter Device Transition Times and Load

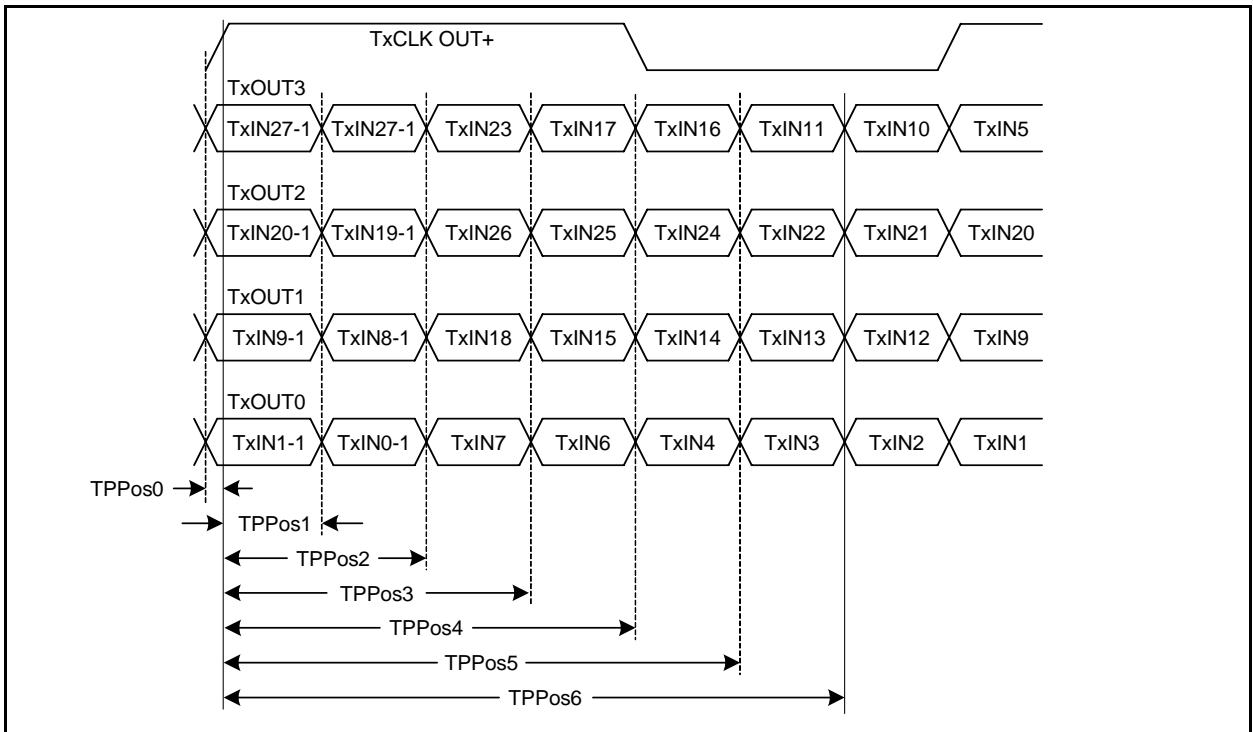

Figure AC5. Transmitter LVDS Output Pulse Position Measurement





V385
8-BIT LVDS TRANSMITTER FOR VIDEO

Package Outline and Package Dimensions (56-pin TSSOP)

Package dimensions are kept current with JEDEC Publication No. 95

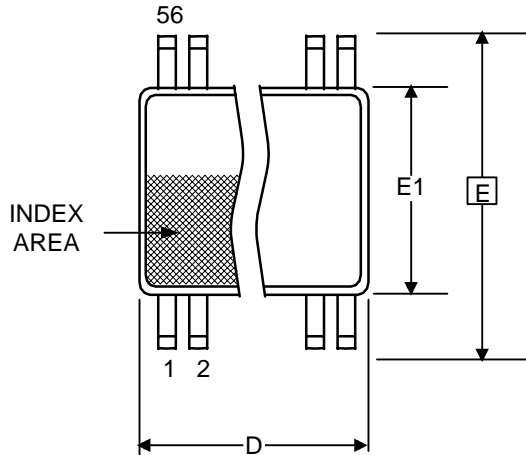

Symbol	Millimeters		Inches*	
	Min	Max	Min	Max
A	—	1.20	—	0.047
A1	0.05	0.15	0.002	0.006
A2	0.80	1.05	0.032	0.041
b	0.17	0.27	0.007	0.011
C	0.09	0.20	0.0035	0.008
D	13.90	14.10	0.547	0.555
E	8.10 BASIC		0.319 BASIC	
E1	6.00	6.20	0.236	0.244
e	0.50 BASIC		0.020 BASIC	
L	0.45	0.75	0.018	0.030
a	0°	8°	0°	8°
aaa	—	0.10	—	0.004

* For reference only. Controlling dimensions in mm.

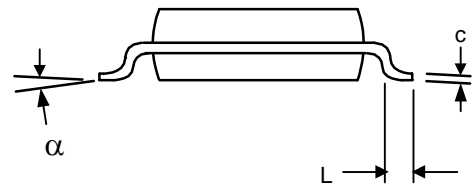
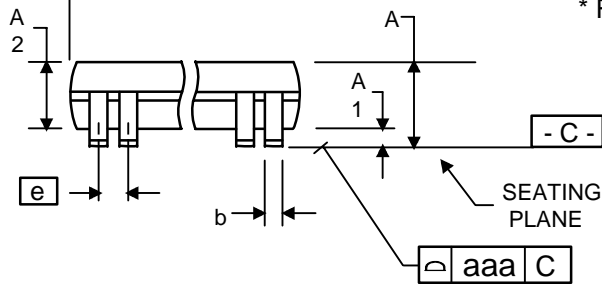



V385

8-BIT LVDS TRANSMITTER FOR VIDEO

Ordering Information

Part / Order Number	Marking	Shipping Packaging	Package	Temperature	Notes
V385AG	V385AG	Tubes	56-pin TSSOP	0 to +70° C	
V385AGT	V385AG	Tape and Reel	56-pin TSSOP	0 to +70° C	
V385AGLF	V385AGLF	Tubes	56-pin TSSOP	0 to +70° C	
V385AGLFT	V385AGLF	Tape and Reel	56-pin TSSOP	0 to +70° C	
V385GLF	V385GLF	Tubes	56-pin TSSOP	0 to +70° C	Replaced by V385AGLF
V385GLFT	V385GLF	Tape and Reel	56-pin TSSOP	0 to +70° C	Replaced by V385AGLFT

Parts that are ordered with a "LF" suffix to the part number are the Pb-Free configuration and are RoHS compliant.

While the information presented herein has been checked for both accuracy and reliability, Integrated Circuit Systems (ICS) assumes no responsibility for either its use or for the infringement of any patents or other rights of third parties, which would result from its use. No other circuits, patents, or licenses are implied. This product is intended for use in normal commercial applications. Any other applications such as those requiring extended temperature range, high reliability, or other extraordinary environmental requirements are not recommended without additional processing by ICS. ICS reserves the right to change any circuitry or specifications without notice. ICS does not authorize or warrant any ICS product for use in life support devices or critical medical instruments.

