

Current Regulated PCI Hot Plug Power Switch Controller

The ISL6111 is designed for use in PCI and PCI-X applications where active current regulation protection of the motherboard from an abnormal PCI load card is desired.

With the addition of two discrete power MOSFETs and a few passive components, the ISL6111 provides power control for the four legacy supplies (-12V, +12V, +5V, +3.3V) to a PCI or PCI-X slot. This IC integrates the +12V and -12V current sensing and regulation switches. On the 25W capable 3.3V and 5V rails, current regulation (CR) protection is provided by sensing the voltage across external current-sense resistors and modulation of the gate voltage bias on the external N-channel power MOSFETs.

During initial power-up of the +12V bias supply, the ENABLE (EN), Power Good (PG), fault monitoring and reporting function functions are inhibited if bias voltage <10V. Once the FETs are enabled they are soft started into the load thus eliminating supply rail disturbances.

Upon a failure that quickly causes a load current greater than the programmed CR level on any voltage supply, the ISL6111 enters its current regulation (CR) mode, limiting the load current to the user programmed level for the user determined period of time. The CR level and duration are set by a single resistor and capacitor respectively. At the end of the CR duration all the switches will latch off pulling the outputs low along with the CRTIM (current regulation timer) and FLTN (fault not) pins indicating a latch-off due to an over current (OC) condition. If a severe OC condition should occur, then the ISL6111 immediately latches off all outputs and sets the FLTN output low.

During operation, if any of the positive voltages falls below the minimum PCI specified levels the power good (PG) output will pull low indicating a non compliant voltage to a load. PG is an open drain output as is FLTN.

The CRSET pin allows programming of the current regulation levels to be scaled up or down from the PCI specified levels via a resistor connected between the CRSET pin and ground.

All faults and latches are cleared by ENABLE being deasserted low.

Features

- Active Current Regulation for Protection
- Adjustable Current Regulation Duration and Magnitude
- Internal MOSFET Switches for +12V and -12V Outputs
- Provides Fault Isolation
- Adjustable Turn-On Slew Rate
- Minimum Parts Count Solution
- No Charge Pump
- 1 μ s Response Time to Over Current
- Pb-Free leadframe

Applications

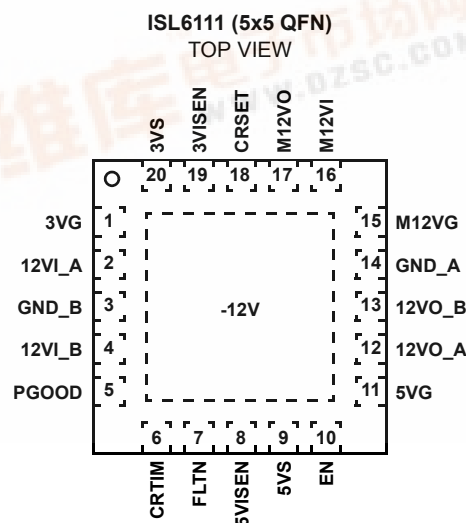
- PCI
- PCI-X 1.0

Ordering Information

PART NUMBER	TEMP. RANGE (°C)	PACKAGE	PKG. DWG. #
ISL6111CRZA (see Note)	0 to 75	20 Ld 5x5 QFN (Pb-Free)	L20.5x5
ISL6111EVAL2	Evaluation Platform		

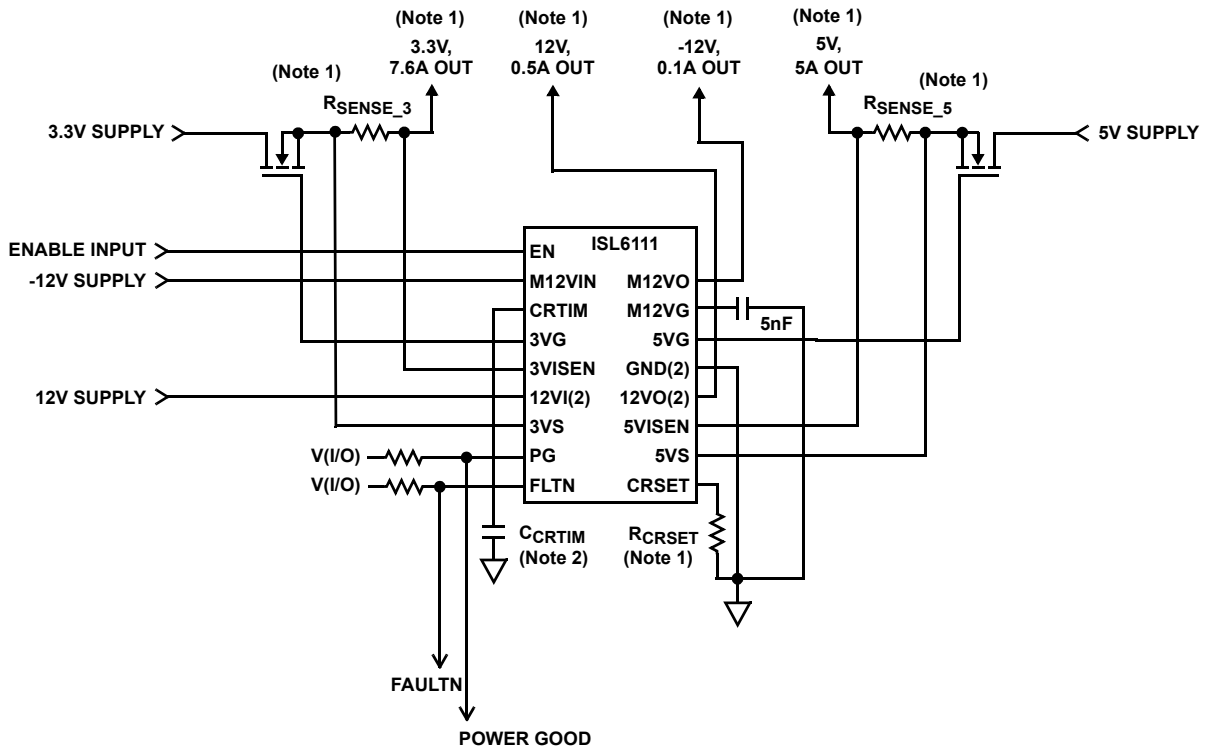
NOTE: Intersil Lead-Free products employ special lead-free material sets; molding compounds/die attach materials and 100% matte tin plate termination finish, which is compatible with both SnPb and lead-free soldering operations. Intersil Lead-Free products are MSL classified at lead-free peak reflow temperatures that meet or exceed the lead-free requirements of IPC/JEDEC J Std-020B.

Pinout



ISL6111

Typical Application



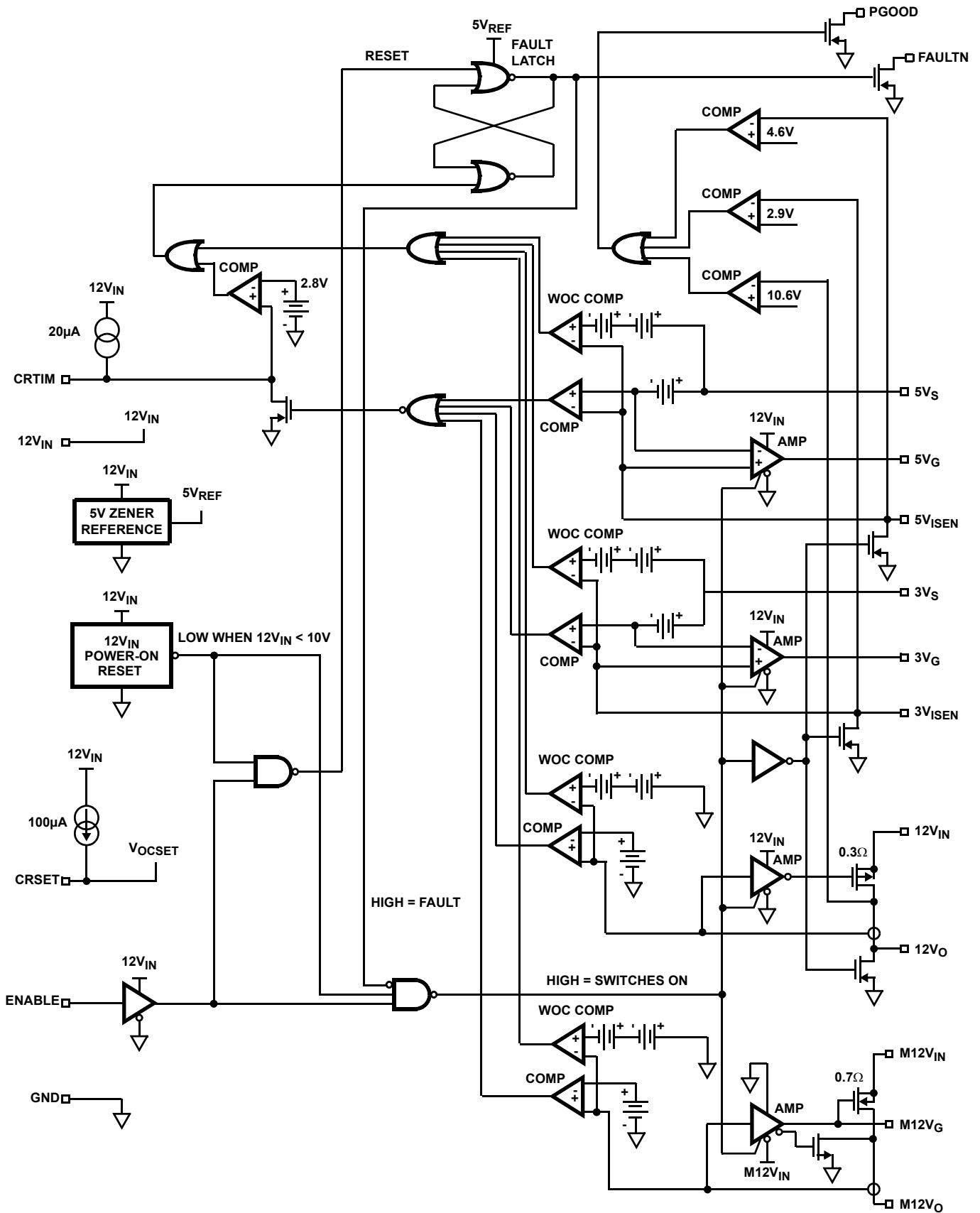
NOTES:

1. See Table 1 for CR level formula
2. See Table 2 for CR duration vs C_{TIM} .

FIGURE 1. ISL6111 TYPICAL APPLICATION SCHEMATIC

ISL6111

Simplified Schematic



ISL6111

Pin Descriptions

PIN NO.	DESIGNATOR	FUNCTION	FUNCTION DESCRIPTION
1	3VG	3.3V FET Gate Output	Drives the gate of the 3.3V MOSFET. Connect to the gate of the external N-Channel MOSFET. At turn-on the FET gate capacitance will be charged to 12VIN voltage by a 10 μ A current source. An optional capacitor from this node to ground will adjust the turn-on ramp.
2, 4	12VI	12V Input	+12V IC bias supply and power supply rail input to internal power switch.
3, 14	GND	IC Ground Reference	Connect to common of power supplies.
5	PGOOD	Power Good	An open drain logic output that is released to indicate all positive voltage outputs are above minimum PCI spec. Connect to V(I/O) through resistor.
6	CRTIM	Current Regulation Duration Input	An external capacitor from this pin to ground sets the current regulation duration before latch off. This output will pull low after the current regulation threshold duration has expired. CR duration = 150K x CTIM. This pin sources 20 μ A and has a threshold trip voltage of 2.83V.
7	FLTIN	Fault Indication	A fault-not open drain output. Latches low once current regulation time has expired. Reset by 12VIN POR condition or enable input signaled low. Connect to V(I/O) through resistor.
8	5VISEN	5V Current Sense	Connect to the load side of the current sense resistor in series with source of external 5V MOSFET. Monitors voltage to load.
9	5VS	5V Source	Connect to source of 5V MOSFET switch. This connection along with 5VISEN senses the voltage drop across the sense resistor.
10	EN	Enable Input	Controls all four internal and external switches, initiates turn-on/off
11	5VG	5V FET Gate Output	Drives the gate of the 5V MOSFET. Connect to the gate of the external N-Channel MOSFET. At turn-on the FET gate capacitance will be charged to 12VIN voltage by a 10 μ A current source. An optional capacitor from this node to ground will adjust the turn-on ramp
12, 13	12VO	Switched 12V Output	Switched 12V output.
15	M12VG	Gate of Internal NMOS	Connect a 5nF capacitor between M12VG and ground to stabilize the start-up ramp for the M12V supply. This capacitor is charged with 25 μ A during start-up.
16	M12VI	-12V Input	-12V Supply Input. Also provides power to the -12V current regulation circuitry.
17	M12VO	Switched -12V Output	Switched -12V Output.
18	CRSET	Current Regulation Set	Program current regulation levels for all four switches by connecting a resistor to GND. This pin sources 100 μ A. See Table 1 for CR level setting formulae.
19	3VISEN	3.3V Current Sense	Connect to the load side of the current sense resistor in series with source of external 3.3V MOSFET. Monitors voltage to load.
20	3VS	3.3V Source	Connect to source of 3.3V MOSFET. This connection along with 3VISEN senses the voltage drop across the sense resistor.

ISL6111

Absolute Maximum Ratings

12VI	-0.5V to +15.0V
12VO, 3VG, 5VG	-0.5V to 12VI+0.5V
M12VI	-14.0V to +0.5V
M12VO, M12VG	$V_{M12VI}-0.5V$ to +0.5V
3VISEN, 5VISEN	-0.5V to the Lesser of 12VI or +7.0V
Voltage, Any Other Pin	-0.5V to +7.0V
12VO Output Current	.3A
M12VO Output Current	.0.8A
ESD Classification	.4KeV (HBM)

Thermal Information

Thermal Resistance (Typical, Notes 3, 5)	θ_{JA} (°C/W)	θ_{JC} (°C/W)
QFN Package	31	2.5
Maximum Junction Temperature	150°C	
Maximum Storage Temperature Range	-65°C to 150°C	
Maximum Lead Temperature (Soldering 10s)	300°C	

Operating Conditions

12VIN Supply Voltage Range	+10.8V to +13.2V
5V and 3.3V Input Supply Tolerances	±10%
12VO Output Current	.0 to +0.5A
M12VO Output Current	.0 to +0.1A
Temperature Range (T _A)	0°C to 85°C

CAUTION: Stresses above those listed in "Absolute Maximum Ratings" may cause permanent damage to the device. This is a stress only rating and operation of the device at these or any other conditions above those indicated in the operational sections of this specification is not implied.

NOTES:

- θ_{JA} is measured in free air with the component mounted on a high effective thermal conductivity test board with "direct attach" features. See Tech Brief TB379.
- All voltages are relative to GND, unless otherwise specified.
- For θ_{JC} , the "case temp" location is the center of the exposed metal pad on the package underside.

Electrical Specifications

Nominal 5.0V and 3.3V Input Supply Voltages,
12VI = 12V, M12VI = -12V, T_A = T_J = 0 to 75°C, Unless Otherwise Specified

PARAMETER	SYMBOL	TEST CONDITIONS	MIN	TYP	MAX	UNITS
5V/3.3V CURRENT CONTROL						
5V Current Regulation Threshold Voltage	V _{OC5V}	V _{CRSET} = 0.3V	-	26.5	-	mV
5V WOC Threshold Voltage	V _{OC5V_woc}	V _{CRSET} = 0.3V	-	49	-	mV
5V Current Regulation Level	I _{CR5V_3}	R _{CRSET} = 3K (See Figure 1, Typical Application)	-	5.3	-	A
	I _{CR5V_35}	R _{CRSET} = 3.5K (See Figure 1, Typical Application)	-	5.8	-	A
	I _{CR5V_4}	R _{CRSET} = 4K (See Figure 1, Typical Application)	-	6.4	-	A
	I _{CR5V_46}	R _{CRSET} = 4.64K (See Figure 1, Typical Application)	-	7.2	-	A
Slow Ramping Current Trip Level	CT/CR	di/dt = 0.001A/s, Current Trip Level/Current Regulation Level	-	90	-	%
Current Trip Level Temp Coeff.	CT_t	dCT/85°C (See Figure 1, Typical Application)	-	3.5	-	mA/°C
5V Undervoltage Threshold	V _{5VUV}		4.51	4.57	4.64	V
5V Turn-On Time (EN to 5VOUT = 4.5V)	t _{ON5V}	C _{5VOUT} = 3300μF, R _L = 1Ω, V _{CRSET} = 0.35V	-	7	-	ms
5V Turn-Off Time (EN to 5VOUT = 0.5V)	t _{OFF5V}	C _{5VOUT} = 3300μF, R _L = 1Ω, V _{CRSET} = 0.35V	-	6	-	ms
3.3V Current Regulation Threshold Voltage	V _{OC3V}	V _{CRSET} = 0.3V	-	39.5	-	mV
3.3V WOC Threshold Voltage	V _{OC3V_woc}	V _{CRSET} = 0.3V	-	80	-	mV
3.3V Current Regulation Level	I _{CR3V_3}	R _{CRSET} = 3K (See Figure 1, Typical Application)	-	7.9	-	A
	I _{CR3V_35}	R _{CRSET} = 3.5K (See Figure 1, Typical Application)	-	8.7	-	A
	I _{CR3V_4}	R _{CRSET} = 4K (See Figure 1, Typical Application)	-	9.8	-	A
	I _{CR3V_46}	R _{CRSET} = 4.64K (See Figure 1, Typical Application)	-	10.9	-	A
Slow Ramping Current Trip Level	CT/CR	di/dt = 0.001A/s, Current Trip Level/Current Regulation Level	-	90	-	%

ISL6111

Electrical Specifications Nominal 5.0V and 3.3V Input Supply Voltages,
12VI = 12V, M12VI = -12V, $T_A = T_J = 0$ to 75°C , Unless Otherwise Specified **(Continued)**

PARAMETER	SYMBOL	TEST CONDITIONS	MIN	TYP	MAX	UNITS
Current Trip Level Temp Coeff.	CT_t	dCT/85°C (See Figure 1, Typical Application)	-	3.5	-	mA/°C
3.3V Undervoltage Threshold	V _{3VUV}		2.7	2.8	2.9	V
3.3V Turn-On Time (EN to 3VOUT = 3V)	t _{ON3V}	C _{3VOUT} = 3300μF, R _L = 0.5Ω, V _{CRSET} = 0.35V	-	6	-	ms
3.3V Turn-Off Time (EN to 3VOUT = 3V)	t _{OFF3V}	C _{3VOUT} = 3300μF, R _L = 0.5Ω, V _{CRSET} = 0.35V	-	5	-	ms
Current Limit Amp Offset Voltage	V _{io_ft}	VS - VISEN	-6	0	6	mV
Current Limit Amp Offset Voltage	V _{io_pt}	VS - VISEN, T _J = 15°C to 55°C	-2	0	2	mV
EXTERNAL GATE DRIVE						
Response Time to OC	pd_oc_amp	V _{GATE} to 11V	-	100	-	ns
Response Time to OC	pd_oc_gate_10	V _{GATE} to 10V	-	10	-	μs
Turn-off Time To WOC	pd_woc_amp	V _{GATE} to 2V	-	1	-	μs
Turn-On Current	I _{GATE}	V _{GATE} to = 6V	8	10	12	μA
Turn-On Time (EN to VG = 1V)	t _{ONGATE}	3VG, 5VG Rising to 1V	-	400	-	μs
Pull Down Current	OC_GATE_I_4V	Overcurrent	20	35	50	mA
WOC Pull Down Current	WOC_GATE_I_4V	Severe Overcurrent	0.5	0.8	1.5	A
High Voltage	VG_high	Gate On Voltage	VDD-1V	VDD	-	V
Low Voltage	VG_low	Gate Off Voltage	-	0.5	0.7	V
+12V SUPPLY CONTROL						
On Resistance of Internal PMOS @ 0.5A	r _{DS(ON)12}	T _A = T _J = 25°C	-	0.3	-	Ω
		T _A = T _J = 85°C	-	0.35	-	Ω
Current Regulation Level	I _{CR12V}	V _{CRSET} = 0.3V	0.45	0.52	0.55	A
	I _{CR12V_35}	R _{CRSET} = 3.5K	-	0.54	-	A
	I _{CR12V_4}	R _{CRSET} = 4.0K	-	0.56	-	A
	I _{CR12V_45}	R _{CRSET} = 4.64K	-	0.62	-	A
Slow Ramping Current Trip Level	CT/CR	di/dt = 0.001A/s, Current Trip Level/Current Regulation Level	-	80	-	%
Current Trip Level Temp Coeff.	12VCT_t	dCT/85°C	-	0.6	-	mA/°C
12V Undervoltage Threshold	V _{12VUV}		10.57	10.7	10.9	V
Vout Turn-On Time	t _{ON12V}	12V Rising 10% - 90%, C _{12VO} = 50μF, R _L = 25Ω	-	1.7	-	ms
Vout Turn-On Time	t _{ON12V}	12V Rising 10% - 90%, C _{12VO} = 300μF, R _L = 25Ω	-	5	-	ms
Vout Turn-Off Time	t _{OFF12V}	12V Falling 90% - 10%, C _{12VO} = 300μF, R _L = 25Ω	-	15	-	ms
Vout Turn-Off Time WOC	t _{OFF12WOC}	12V Falling 90% - 10%, C _{12VO} = 300μF, R _L = 25Ω	-	35	-	μs
Vout Turn-Off Voltage	V _{OFF12}	Vout when off	-	0.3	-	V
-12V SUPPLY CONTROL						
On Resistance of Internal NMOS @ 0.1A	r _{DS(ON)M12}	T _A = T _J = 25°C	-	0.7	-	Ω
		T _A = T _J = 85°C	-	0.9	-	Ω
Current Regulation Level	I _{CMR12V}	V _{CRSET} = 0.3V	0.085	0.11	0.135	A
	I _{CMR12V_35}	R _{CRSET} = 3.5K	-	0.115	-	A
	I _{CMR12V_4}	R _{CRSET} = 4.0K	-	0.120	-	A
	I _{CMR12V_45}	R _{CRSET} = 4.64K	-	0.140	-	A

ISL6111

Electrical Specifications Nominal 5.0V and 3.3V Input Supply Voltages,
12VI = 12V, M12VI = -12V, T_A = T_J = 0 to 75°C, Unless Otherwise Specified **(Continued)**

PARAMETER	SYMBOL	TEST CONDITIONS	MIN	TYP	MAX	UNITS
Slow Ramping Current Trip Level	CT/CR	di/dt = 0.001A/s, Current Trip Level/Current Regulation Level	-	90	-	%
Current Trip Level Temp Coeff.	M12VCT_t	dCT/85°C	-	0.1	-	mA/°C
Gate Turn-Off Time	t _{OFFM12VG}	C _{M12VG} = 0.005μF, M12VG Falling 90% to 10%	-	330	-	ns
Gate Response Time To Overcurrent	t _{OC2M12VG}		-	1	1	μs
Gate Response Time to WOC	t _{WOC2M12VG}		-	400	-	ns
Gate Output Charge Current	I _{CM12VG}	ENABLE = High, V _{M12VG} = -10V	-	102	-	μA
Vout Turn-On Time	t _{ONM12VO}	-12V Falling 90% - 10%, C _{M12VO} = 50μF, R _L = 120Ω	-	11	-	ms
Vout Turn-On Time	t _{ONM12VO}	-12V Falling 90% - 10%, C _{M12VO} = 150μF, R _L = 120Ω	-	35	-	ms
Vout Turn-Off Time	t _{OFFM12VO}	-12V Rising 10% - 90%, C _{M12VO} = 150μF, R _L = 120Ω	-	40	-	ms
Vout Turn-Off Time WOC	t _{OFFM12VOWOC}	-12V Rising 10% - 90%, C _{M12VO} = 150μF, R _L = 120Ω	-	15	-	μs
Vout Turn-Off Voltage	V _{OFFM12VO}	Vout when off	-	-0.6	-	V
M12VIN Input Bias Current	I _{BM12VIN}	ENABLE = High	4.5	5.3	7	mA
CONTROL AND I/O PINS						
CRSET Current Source	I _{CRSET}		90	100	110	μA
Rising ENABLE Threshold Voltage	V _{TH_EN_L2H}		1.5	1.7	2.0	V
Falling ENABLE Threshold Voltage	V _{TH_EN_H2L}		1.2	1.5	1.9	V
ENABLE Threshold Voltage Hysteresis	V _{TH_EN_HYS}		-	0.2	0.3	V
Enable to Output Turn-on Prop. Delay	T _{pd_EN}	Enable high to start of output turn-on	-	2	-	ms
Power Good Output Low Voltage	V _{PG,L}	I _{PG} = 5mA	-	0.6	0.75	V
Power Good Output Pull-down Current	I _{PG}		-	40	-	mA
Power Good to Vout Falling Response Time	t _{UV2PG_fall}	Vout < UV Vth to PG low	-	500	-	ns
Power Good to Vout Rising Response Time	t _{UV2PG_rise}	Vout > UV Vth to PG high	-	8	-	ms
FAULTN Output Low Voltage	V _{FLTN,L}	I _{FLTN} = 5mA	-	0.6	0.75	V
FAULTN Output Pull-down Current	I _{FLTN}		-	40	-	mA
FAULTN Output Response Time	t _{OC2FLTN}	C _{TIM,Vth} to FLTN low	-	-	1	μs
CRTIM Charging Current	CRTIM_ichg0	V _{CTIM} = 0V	-	26	-	μA
Current Regulation Time-Out Threshold	CRTIM_Vth	CTIM Voltage	2.74	2.83	2.92	V
BIAS						
12V Lock Out Threshold	V _{POR,THrise}	V _{CC} Voltage Rising	9.88	10.1	10.5	V
12V Power On Reset Threshold	V _{POR,THfall}	V _{CC} Voltage Falling	9.17	9.3	9.43	V
12V Reset Threshold Hysteresis	V _{POR,HYS}		-	0.69	-	V
12V Disabled Supply Current	I _{DIS}	12VIN, EN = 0V	-	3.3	6	mA

Introduction

The ISL6111, is an IC device designed to provide control and protection of the four legacy PCI power supplies (+12V, -12V, +5V and +3.3V) for a single PCI or PCI-X slot. Unlike the widely used HIP1011, this device employs an active current regulation (CR) method to provide system protection against load faults.

Figure 1 illustrates the typical implementation of the ISL6111.

Key Feature Description and Operation

The ISL6111, 2 power MOSFETs and a few passive components as configured in Figure 1, completes a power control solution for the legacy supplies to a PCI slot. It provides protection via a programmable maximum current regulation (CR) level to the load for each supply. For the 3.3V and 5V supplies, current monitoring is provided by sensing the voltage across external current-sense resistors, and CR protection is provided by active voltage modulation of external N-Channel MOSFETs. For the +12V and -12V supplies, current monitoring and CR protection are provided internally.

During initial power-up of the main bias supply pins (12VI), the ENABLE input function is inhibited from turning on the switches, this latch is held in the reset state until the bias voltage is greater than 10V (POR rising). Additionally the power good and fault reporting functions are also disabled at this time and during the soft start duration.

During turn-on of the supplies onto their capacitive loads the current limiting fail-safe is engaged, this limited current gives a voltage ramp-up slew rate centered within the PCI specs. As the startup is current-limited, the CRTIM timer is engaged during the entire startup, as it should be. This eliminates the otherwise destructive case of starting up into a dead short. Depending on loading, the positive 3 supplies will start up and exit current limiting in about 6ms -10ms. The -12V supply will take much longer, as it has a fraction of the available charging current into a potentially relatively very large load capacitance, and the voltage has to slew to -12V. The -12V turn-on duration can thus be several times as long extending to ~50ms for a very capacitive (147 μ F) load in conjunction with a maximum current load. In addition if the CR level is too low then it's possible that the load capacitance cannot fully charge in the allowed for time, this is the consequence of the current regulation limiting protection.

Once turned on, any subsequent over current (OC) condition on any output results in the affected switch (external or internal) to be put into its linear mode of operation, and the current is regulated to the level determined by the choice of external CRSET resistor value. An OC condition is defined as a current level > the programmed CR level and that transitions through the CR level with a quick ramp, <0.5 μ s. This CR level is maintained until the OC condition passes or the CR duration expires, whichever comes first. The CR

duration is user defined by the capacitor value on the CRTIM pin. Once in CR mode, the CRTIM pin charges the capacitor with a 20 μ A current until the voltage on CRTIM rises to ~2.8V, at which time a turn-off latch is set on all 4 power FET switches. Also at this time the open drain fault (FLT_N) output is pulled low signalling a latched off state. After a fault has been asserted and FLT_N is latched low, cycling ENABLE low will clear the FLT_N latch.

On-chip references in the ISL6111 are used to monitor the +5V, +3.3V and +12V outputs for under voltage (UV) conditions. Once an UV condition is present the open drain power good (PGOOD) output will pull low to indicate this.

Customizing Circuit Performance

Setting Current Regulation (CR) Level

The ISL6111 allows for easy and simultaneous custom programming of the CR levels of all 4 supplies by simply changing the resistor value between CRSET, (pin 18), and ground. The R_{CRSET} value and the CRSET 100 μ A current source create a reference voltage that is used in each of four comparators. The IR voltages developed across the 3.3V and 5V sense resistors are applied to the inputs of their respective comparators opposite this reference voltage. The +12V and -12V currents are sensed internally with pilot devices. Because of the internal current monitoring of the +12V and -12V switches, their programming flexibility is limited to R_{CRSET} changes whereas the 3.3V and 5V over current regulation levels depend on both R_{CRSET} , and the value chosen for each sense resistor.

See Table 1 to determine CR protection levels relative to choice of R_{CRSET} and R_{SENSE} values.

Over current design guidelines and recommendations are as follows:

1. For PCI applications, set R_{CRSET} to 4.22k Ω , and use 5m Ω 1% sense resistors (see Figure 20). This R_{CRSET} value provides a nominal current trip level 110% to 130% higher than the maximum specified current, to ensure full current range use by the PCI load. The ISL6111 will trip off on a slow increasing current ramp approximately 10% to 20% lower than set CR level.
2. For non PCI specified applications, the following precautions and limitations apply:
 - A. **Do not** exceed the maximum power of the integrated NMOS and PMOS. High power dissipation must be coupled with effective thermal management and prudent CR durations. The integrated PMOS has an $r_{DS(ON)}$ of 0.35 Ω . With 2.5A of steady load current on the PMOS device the power dissipation is 2.2W. The thermal impedance of the package is 31 degrees Celsius per watt, resulting in a 68 $^{\circ}$ C die temp rise thus limiting the average DC current on the 12V supply to about 2.5A maximum at +85 $^{\circ}$ C ambient and imposing an upper limit on the R_{OCSET} resistor. **Do not** use an R_{CRSET} resistor greater than 15k Ω .

ISL6111

The average current on the -12V supply should not exceed 0.8A. Since the thermal restrictions on the +12V supply are more severe, the +12V supply restricts the use of the ISL6111 to applications where the $\pm 12V$ supplies draw relatively little current. Since both supplies only have one degree of freedom, the value of R_{OCSET} , the flexibility of programming is quite limited. For applications where more power is required on the +12V supply, contact your local Intersil sales representative for information on other Hot Plug solutions.

- B. **Do not** try to sense voltages across the external sense resistors that are less than 20mV as spurious faults due to noise and comparator input sensitivity may result. The minimum recommended R_{CRSET} value is 3.0k Ω . This will set the nominal OC voltage thresholds at 39mV and 26mV for the 3.3V and 5V comparators respectively.
- C. Minimize V_{RSENSE} so as to not significantly reduce the voltage delivered to the adapter card. Remember PCB trace and connector distribution voltage losses also need to be considered. Make sure that the R_{SENSE} resistor can adequately handle the dissipated power. For best results use a 1% precision resistor with a low temperature coefficient.
- D. Minimize external FET $r_{DS(ON)}$. Low $r_{DS(ON)}$ or multiple MOSFETs in parallel are recommended.

TABLE 1.

SUPPLY	NOMINAL CURRENT REGULATION LEVEL (10%) FOR EACH SUPPLY
+3.3V I_{CR}	$((100\mu A \times R_{CRSET})/8.54)/R_{RSENSE}$
+5.0V I_{CR}	$((100\mu A \times R_{CRSET})/12)/R_{RSENSE}$
+12V I_{CR}	$(100\mu A \times R_{CRSET})/0.7$
-12V I_{CR}	$(100\mu A \times R_{CRSET})/3.3$

Current Regulation Delay Time to Latch-Off

The CR time delay to latch-off, allows for a predetermined delay from the start of CR, to the simultaneous latch-off of all four supply switches to the load. This delay period is set by the capacitor value to ground from the CRTIM pin. This feature allows the ISL6111 to provide a current regulated soft start into all loads, and to delay immediate latch-off of the bus supply switches thus ignoring transient OC conditions. See Table 2. for CR duration vs CRTIM capacitance value.

TABLE 2.

CRTIM, VALUE	0.022F	0.1 μ F	1 μ F
Nominal CR Duration	3.3ms	15ms	150ms
Nominal CR Duration = 150k Ω X TIM cap value.			

Caution: An additional concern about long CR durations along with MB supply droop is power-FET survivability. The primary purpose of a protection device such as the ISL6111 is to quickly isolate a faulted card from the voltage bus.

Delaying the time to latch-off works against this primary concern so understand the limitations and realities. Since we use the same CRTIM cap timing cap for all supplies, we have to set that cap to a size large enough to allow the -12V to start up under the worst load for a given system. If we set this to a 75ms duration, then this 75ms time-out duration will also be used when one of the higher power supplies goes into current limiting after startup is complete. The highest power supplies, the 3.3V and 5V each run to a maximum of 25W, as allowed by the PCI spec. If our overcurrent duration is set to 75ms, then theoretically (but extremely unlikely) more than 25W can be dissipated in the external FET for that whole duration. The ISL6111 has a way over-current "WOC" circuit that faults the chip off instantly if this theoretical dead short happens so quickly that the current limiting circuitry can't keep up. In reality, overcurrent is more likely to not be a zero-ohm short, and only a fraction of the power is dissipated in the FET.

Ensure adequate sizing of external FETs to carry additional current during CR period in linear operation. By looking at the SOA of the Siliconix Si4404DY FET and even presupposing the full 25W for 100ms duration for a single pulse is not an issue with this power FET. This FET is representative of FETs for a PCI application. If for a higher power non PCI design, consult the MOSFET vendor SOA curves.

Application Considerations

Soft Start and Turn-Off Considerations

The ISL6111 does allow the user to select the rate of ramp up on the voltage supplies. This start-up ramp minimizes in-rush current at start-up while the on card bulk capacitors charge. The ramp is created by placing capacitors on M12VG, 3VG and 5VG to ground. These capacitors are each charged up by a nominal 25 μ A current during turn on. The +12VO has internal current controlled ramping circuitry. The same value for all gate timing capacitors is recommended. The gate capacitors must be discharged when a fault is detected to turn off the power FETs thus, larger caps slow the response time. If the gate capacitors are too large the ISL6111 may not be able to adequately protect the bus or the power FETs. The ISL6111 has internal discharge FETs to discharge the load when disabled. Upon turn-off these internal switches on each output discharge the load capacitance pulling the output to gnd. These switches are also on when ENABLE is low thus an open slot is held at the gnd level.

Recommended PCB Layout Design

To ensure accurate current sensing and control, the PCB traces that connect each of the current sense resistors to the ISL6111 must not carry any load current. This can be accomplished by two dedicated PCB kelvin traces directly from the sense resistors to the ISL6111, see examples of correct and incorrect layouts below in Figure 2. To reduce

parasitic inductance and resistance effects, maximize the width of the high-current PCB traces.

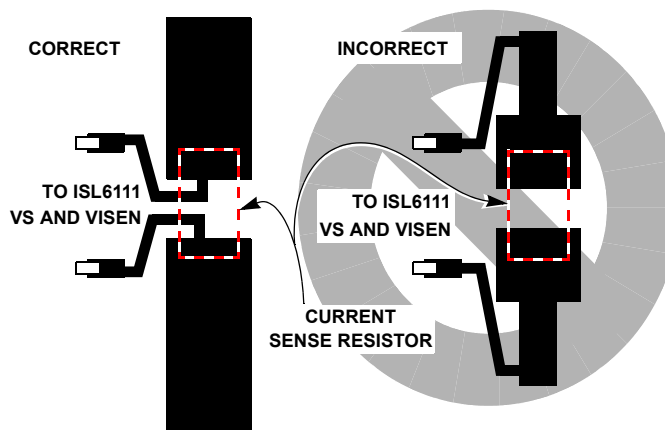


FIGURE 2. SENSE RESISTOR PCB LAYOUT

PGOOD vs Power is Good and Fault Signals

Keep in mind that the -12VOUT is not monitored for under voltage, thus the PGOOD output signal only takes into account the three positive supplies. PGOOD will assert once all minimum positive UV criteria is reached and the M12VO may not be more than a few volts below ground at that time. It will pull low once any positive voltage < UV Vth. For applications that don't use -12V, the M12VI pin on the

ISL6111 is simply grounded. The Fault-not output, FLTIN pulls low once the CR duration has expired and signals that all supplies have been disconnected from the load. See Figure 3 for operational PGOOD and FLTIN waveforms.

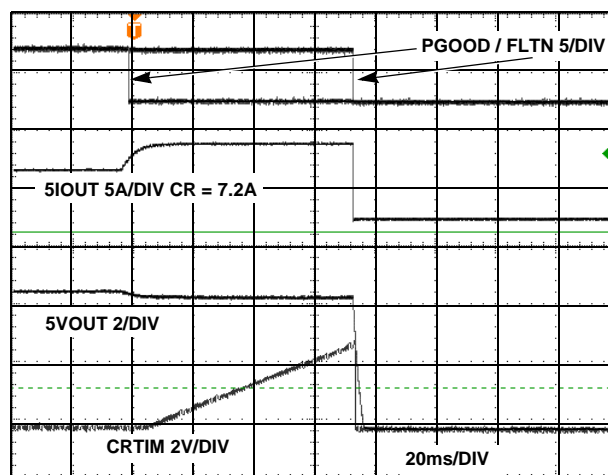


FIGURE 3. FLTIN & PGOOD FUNCTIONAL WAVEFORM

Adjusting the Current Regulation Level

The current regulation level is adjusted by the CRSET resistance to ground value. The ratio of resistance to CR change is not linear but is unidirectional in relationship, see Figures 4-6.

Typical Performance Curves & Waveforms

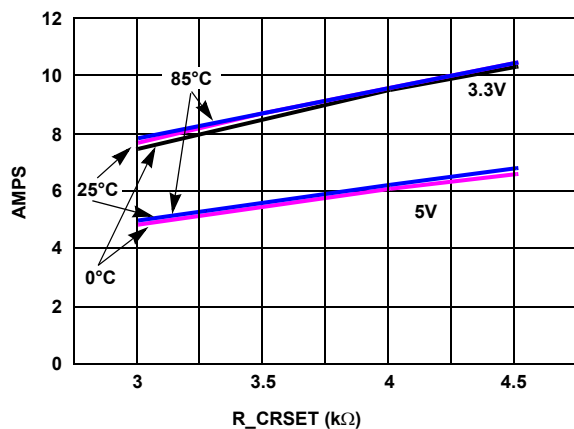


FIGURE 4. 3.3V & 5V SLOWLY INCREASING CURRENT TRIP LEVEL vs TEMPERATURE AND RCRSET

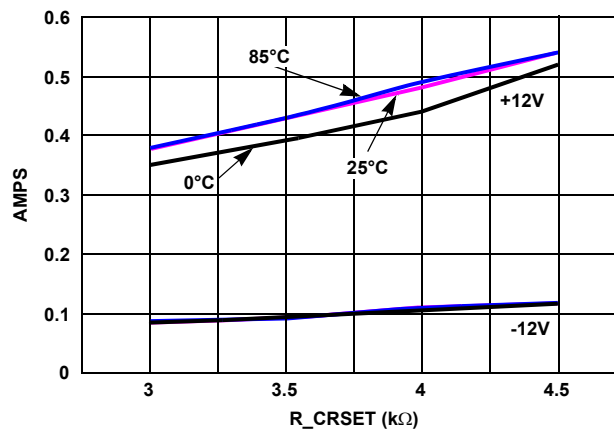


FIGURE 5. +12V & -12V SLOWLY INCREASING CURRENT TRIP LEVEL vs TEMPERATURE AND RCRSET

Typical Performance Curves & Waveforms (Continued)

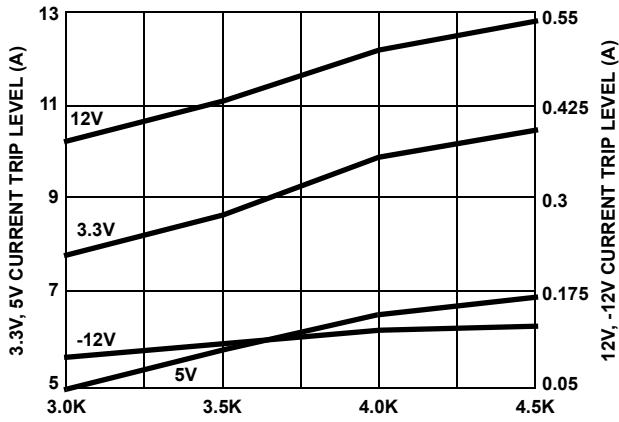


FIGURE 6. NOMINAL CURRENT TRIP LEVEL vs RCRSET

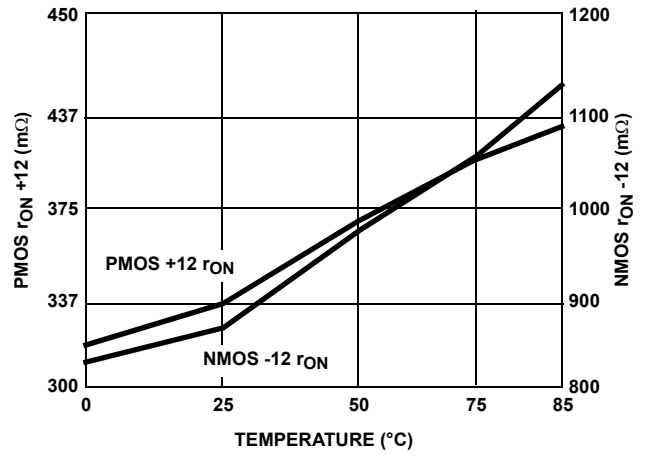


FIGURE 7. r_{ON} vs TEMPERATURE

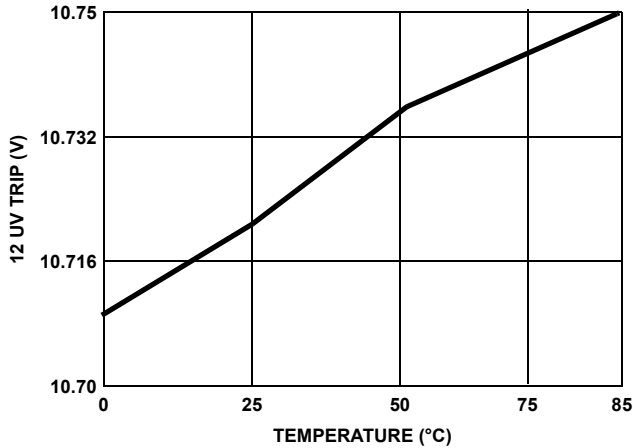


FIGURE 8. 12V UV V_{th} vs TEMPERATURE

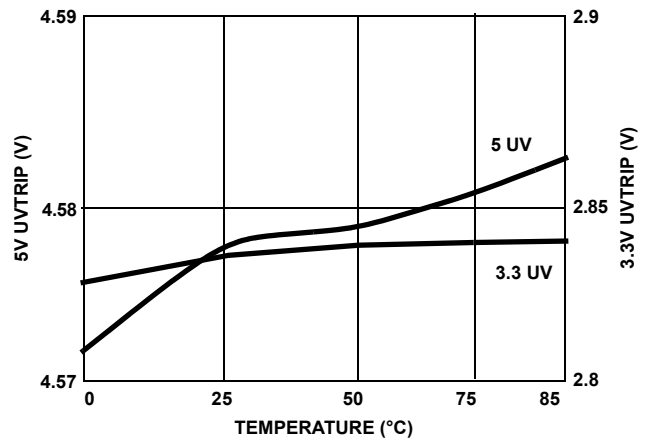


FIGURE 9. UV TRIP vs TEMPERATURE

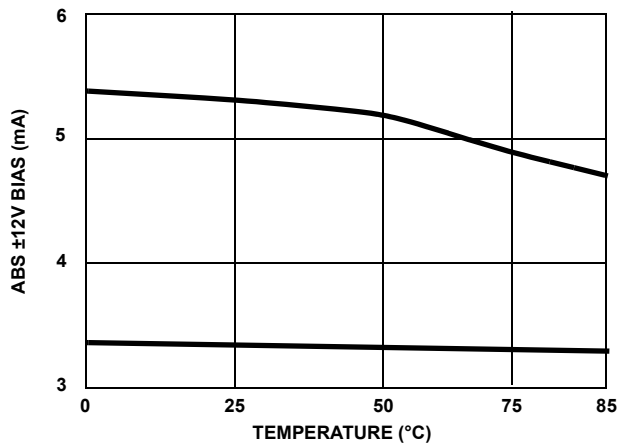


FIGURE 10. BIAS CURRENT vs TEMPERATURE

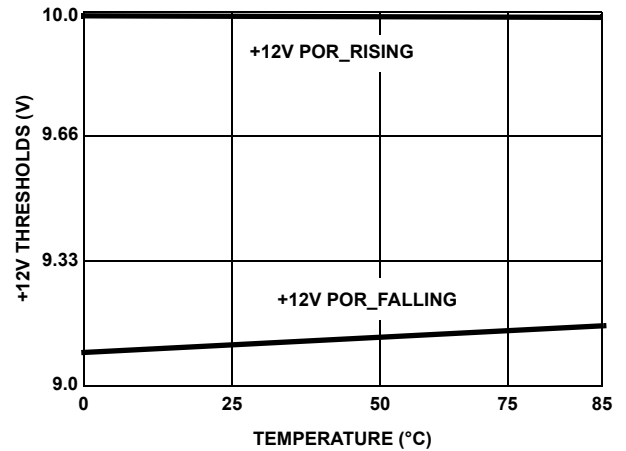


FIGURE 11. 12V ENABLE AND RESET THRESHOLD VOLTAGES vs TEMPERATURE

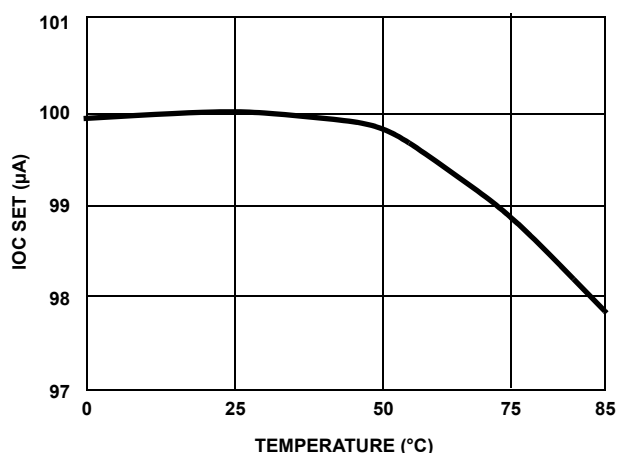
Typical Performance Curves & Waveforms (Continued)

FIGURE 12. CRSET CURRENT vs TEMPERATURE

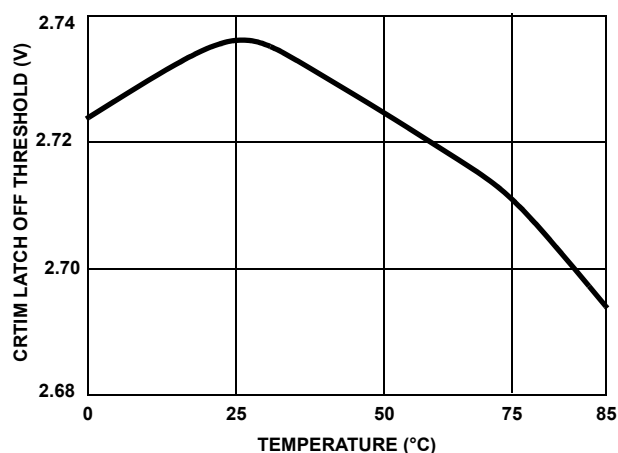


FIGURE 13. CRTIM THRESHOLD VOLTAGE vs TEMPERATURE

Using the ISL6111EVAL2 Platform**Biasing and General Information**

The ISL6111EVAL2 platform (Figure 20) allows a designer to evaluate and modify the performance and functionality of the ISL6111 in a simple environment. The board is made such that the heat dissipating resistors are shielded from users and equipment by being placed on the bottom, despite this the top of the load board still gets hot.

Test point names correspond to the ISL6111 device (U1) pins. Along with the ISL6111 on the ISL6111EVAL2 platform are 2 N-Channel power MOSFETs, (Q1- Q2) these are used as the external switches for the +5V and +3.3V supplies to the load. Current sensing is facilitated by the two $5\text{m}\Omega$ 1W metal strip resistors (R7, R3), the voltages developed across the sense resistors are compared to references on board the ISL6111.

The ISL6111EVAL2 platform is powered through the 5 labeled jacks on the left half of the board, with outputs on the right half. After properly biasing the ISL6111, signal the ENABLE input high ($>2.4\text{V}$), this will turn on the FET switches and apply voltage to the loads resistors and capacitors.

Voltage and current measurements can be easily made as the test points facilitate access to IC pins and other critical circuit nodes.

Evaluating Current Regulation Duration

The current regulation (CR) duration is set by the CRTIM capacitor value, C3 to ground. This provides a programmable duration during which the ISL6111 holds the programmed CR level. Once this duration has expired and the ISL6111 is still in CR mode the output voltages will turn off.

The intent of any protection device is to quickly isolate the voltage supplies so a faulty load card does not drag down a supply. A duration period too lengthy increases the likelihood of FET switch damage and results in slower isolation of the faulty card from the rest of system.

Figures 14 -19 show nominal turn-on, turn-on into OC condition with CR mode waveforms.

Typical Performance Curves

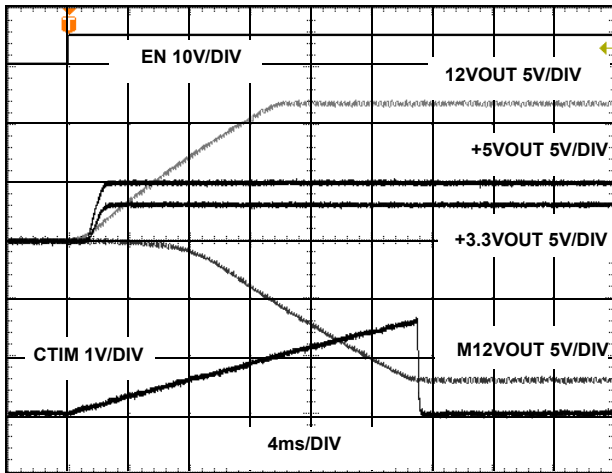


FIGURE 14. ISL6111 TURN-ON INTO NOMINAL LOAD

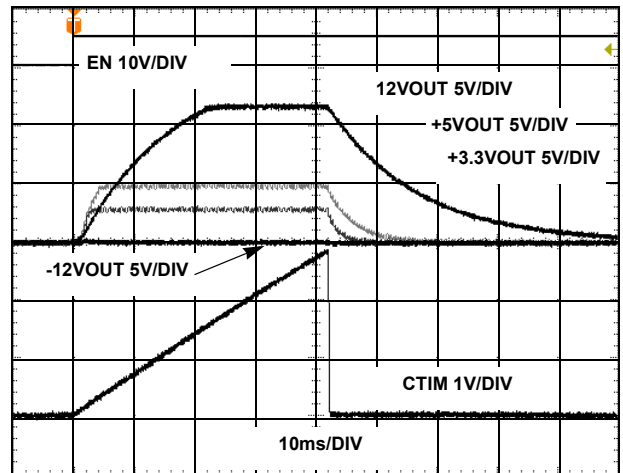


FIGURE 15. ISL6111 TURN-ON INTO M12V OC CONDITION

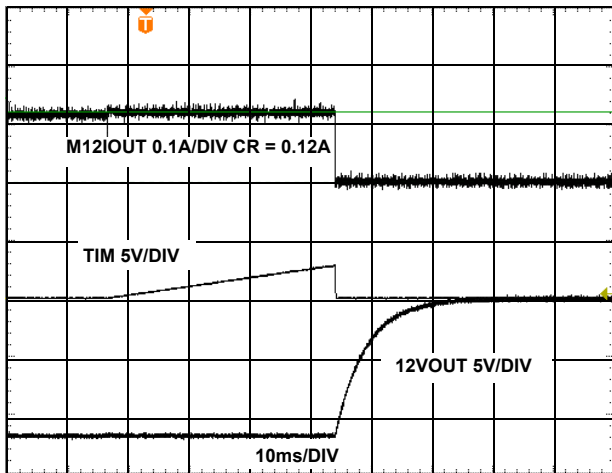


FIGURE 16. M12VOUT INTO CR (VCRSET = 0.461V)

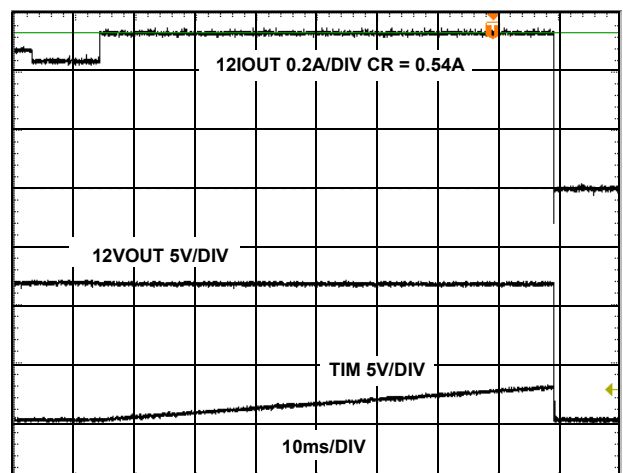


FIGURE 17. 12VOUT INTO CR (VCRSET = 0.461V)

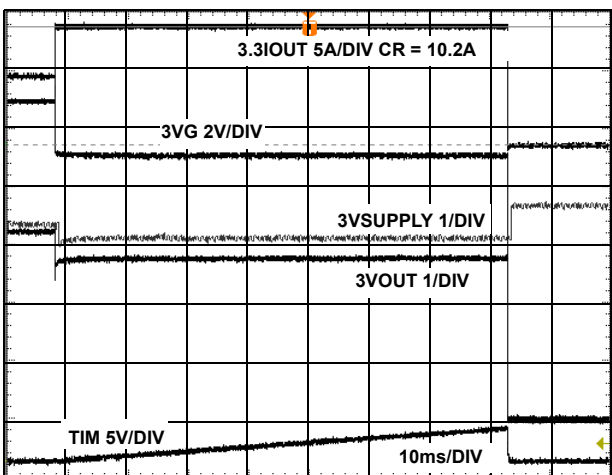


FIGURE 18. 3.3V INTO CR (VCRSET = 0.461V)

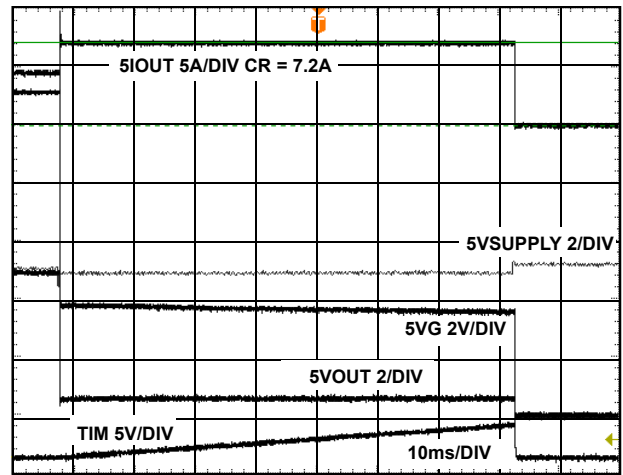


FIGURE 19. 5VOUT INTO CR (VCRSET = 0.461V)

ISL6111

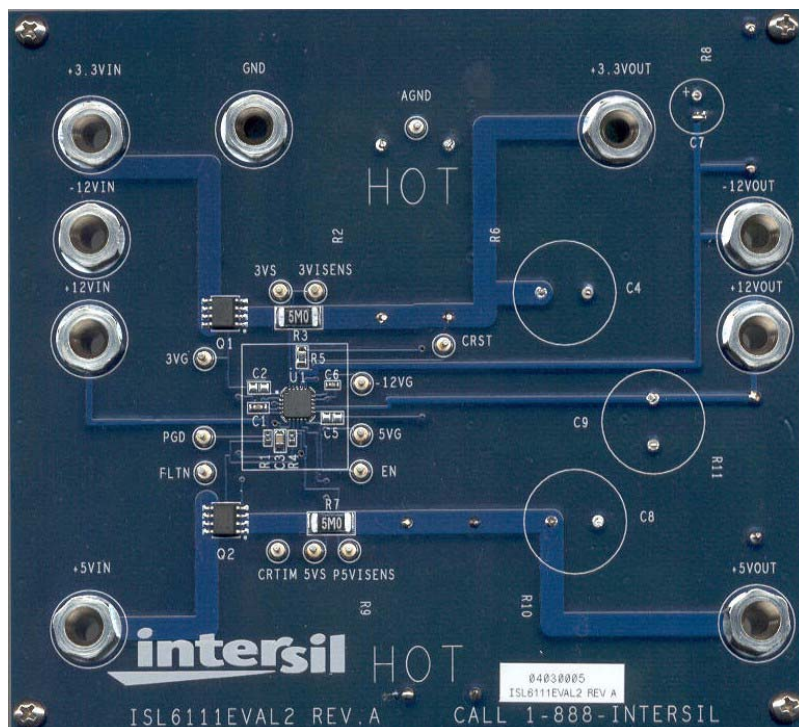
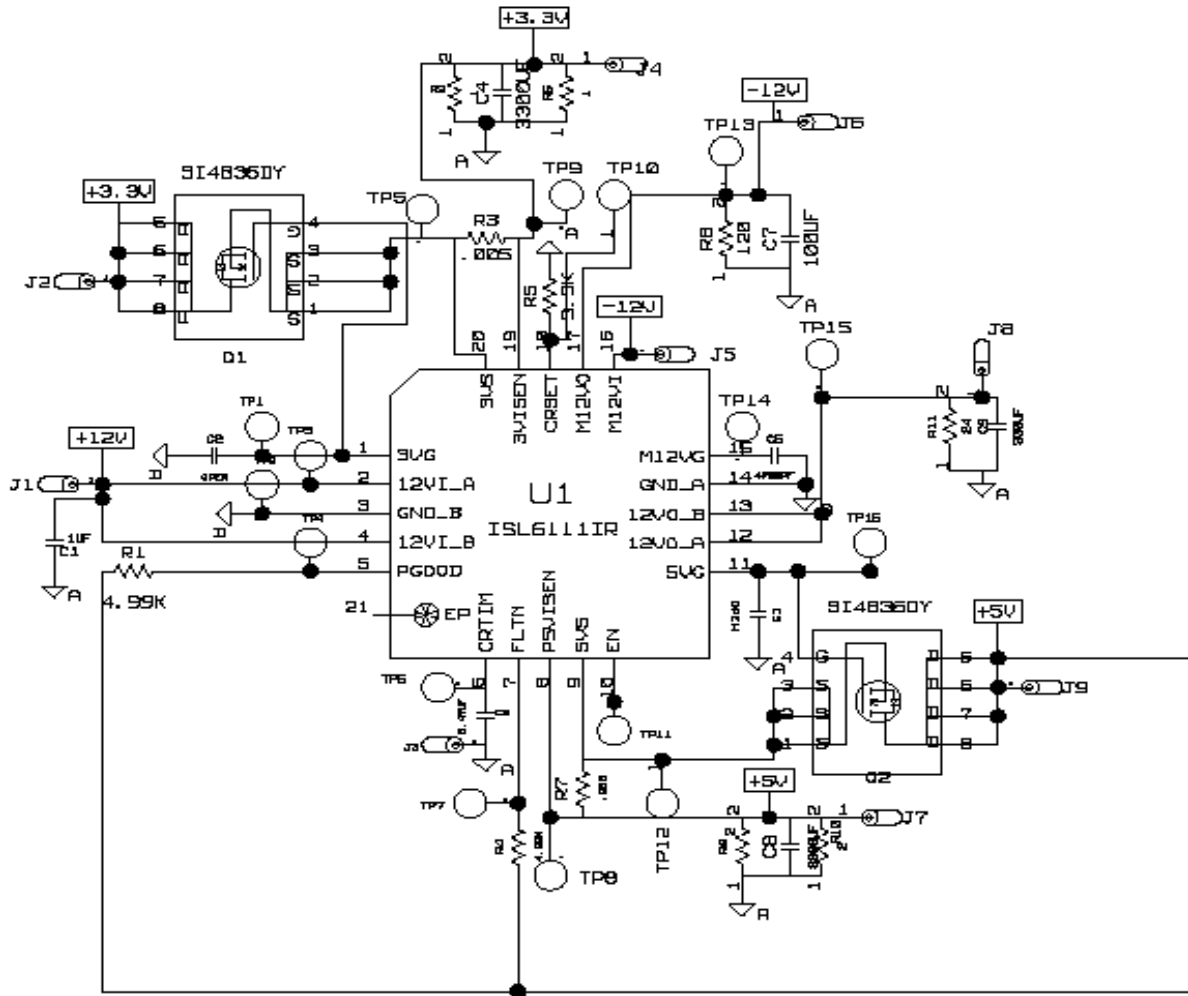


FIGURE 20. ISL6111EVAL2 PLATFORM SCHEMATIC AND PHOTOGRAPH

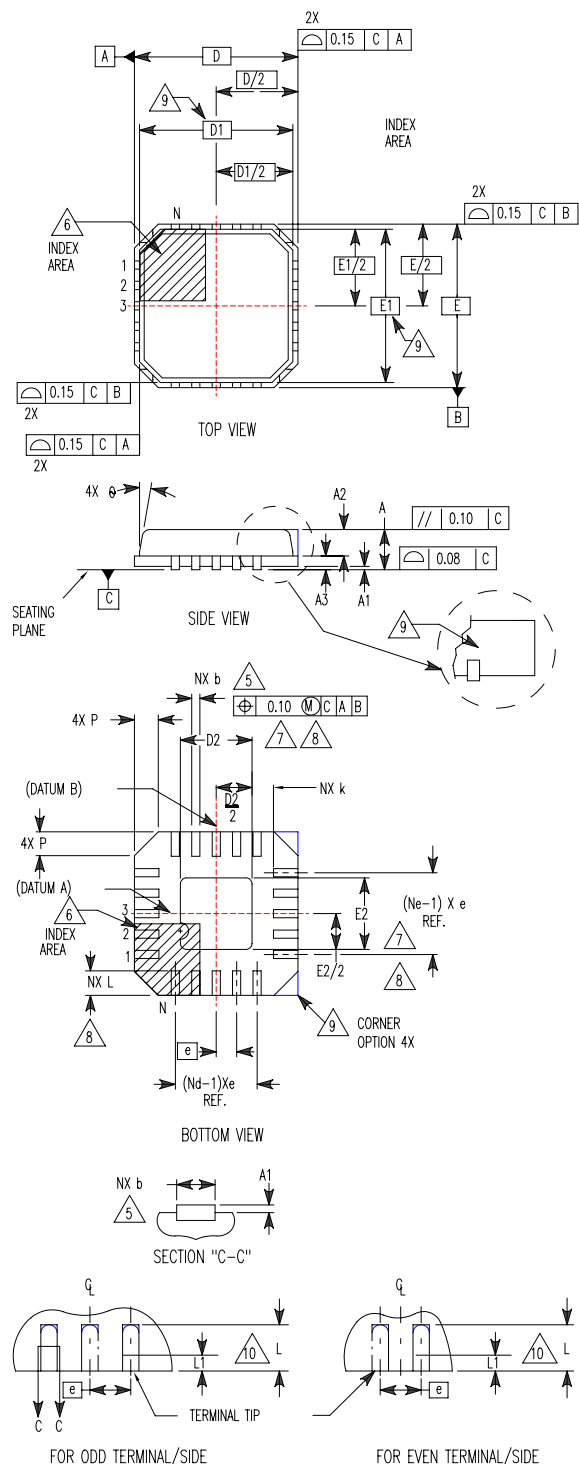
ISL6111

TABLE 3. ISL6111EVAL2 BOARD COMPONENT LISTING

COMPONENT DESIGNATOR	COMPONENT NAME	COMPONENT DESCRIPTION
CONTROLLER BOARD		
U1	ISL6111CR PCI HotPlug Controller	Intersil, ISL6111CR PCI HotPlug Controller
Q1, Q2	Siliconix Si4404DY	4.5mΩ, 30V, 23A Logic Level N-Channel MOSFET or Equivalent
R3, R7	Sense Resistor for 3.3V and 5V Supplies	WSL-2512 5mΩ, 1% Metal Strip Resistor or Equivalent
R5	Current Regulation Set Resistor	4.53kΩ 0805 Chip Resistor
C3	Current Regulation Duration Set Capacitor	0.47μF 0805 Chip Capacitor (CR duration ~70ms)
R1, R4	PGOOD , FLTN Pull-up Resistor	5kΩ 0402 Chip Resistor
C1	12VI Decoupling Capacitor	1μF 0603 Chip Capacitor
C6	M12VG Decoupling Capacitor	5600pF 0402 Chip Capacitor
C2, C5	Optional Gate Timing Capacitors	NOT POPULATED 0805 Chip Capacitor
R2, R6	3.3V Load Resistor	2.2Ω, 5W
R9, R10	5.0V Load Resistor	5.1Ω, 5W
R11	+12V Load Resistor	47Ω, 5W
R8	-12V Load Resistor	240Ω, 2W
C4, C8	+3.3V and +5.0V Load Capacitors	2200μF
C9	+12V Load Capacitor	330μF
C7	-12V Load Capacitor	100μF

ISL6111

Quad Flat No-Lead Plastic Package (QFN) Micro Lead Frame Plastic Package (MLFP)



L20.5x5 20 LEAD QUAD FLAT NO-LEAD PLASTIC PACKAGE (COMPLIANT TO JEDEC MO-220VHHC ISSUE C)

SYMBOL	MILLIMETERS			NOTES
	MIN	NOMINAL	MAX	
A	0.80	0.90	1.00	-
A1	-	-	0.05	-
A2	-	-	1.00	9
A3	0.20 REF			9
b	0.23	0.28	0.38	5, 8
D	5.00 BSC			-
D1	4.75 BSC			9
D2	2.95	3.10	3.25	7, 8
E	5.00 BSC			-
E1	4.75 BSC			9
E2	2.95	3.10	3.25	7, 8
e	0.65 BSC			-
k	0.25	-	-	-
L	0.35	0.60	0.75	8
L1	-	-	0.15	10
N	20			2
Nd	5			3
Ne	5			3
P	-	-	0.60	9
θ	-	-	12	9

Rev. 3 10/02

NOTES:

1. Dimensioning and tolerancing conform to ASME Y14.5-1994.
2. N is the number of terminals.
3. Nd and Ne refer to the number of terminals on each D and E.
4. All dimensions are in millimeters. Angles are in degrees.
5. Dimension b applies to the metallized terminal and is measured between 0.15mm and 0.30mm from the terminal tip.
6. The configuration of the pin #1 identifier is optional, but must be located within the zone indicated. The pin #1 identifier may be either a mold or mark feature.
7. Dimensions D2 and E2 are for the exposed pads which provide improved electrical and thermal performance.
8. Nominal dimensions are provided to assist with PCB Land Pattern Design efforts, see Intersil Technical Brief TB389.
9. Features and dimensions A2, A3, D1, E1, P & θ are present when Anvil singulation method is used and not present for saw singulation.
10. Depending on the method of lead termination at the edge of the package, a maximum 0.15mm pull back (L1) maybe present. L minus L1 to be equal to or greater than 0.3mm.

All Intersil U.S. products are manufactured, assembled and tested utilizing ISO9000 quality systems.
Intersil Corporation's quality certifications can be viewed at www.intersil.com/design/quality

Intersil products are sold by description only. Intersil Corporation reserves the right to make changes in circuit design, software and/or specifications at any time without notice. Accordingly, the reader is cautioned to verify that data sheets are current before placing orders. Information furnished by Intersil is believed to be accurate and reliable. However, no responsibility is assumed by Intersil or its subsidiaries for its use; nor for any infringements of patents or other rights of third parties which may result from its use. No license is granted by implication or otherwise under any patent or patent rights of Intersil or its subsidiaries.

For information regarding Intersil Corporation and its products, see www.intersil.com