

**32-BIT DUAL-SUPPLY BUS TRANSCEIVER
WITH CONFIGURABLE VOLTAGE TRANSLATION AND 3-STATE OUTPUTS**

SCES553C – MAY 2004 – REVISED APRIL 2005

- Member of the Texas Instruments Widebus+™ Family
- Control Inputs V_{IH}/V_{IL} Levels Are Referenced to V_{CCA} Voltage
- V_{CC} Isolation Feature – If Either V_{CC} Input Is at GND, Both Ports Are in the High-Impedance State
- Overvoltage-Tolerant Inputs/Outputs Allow Mixed-Voltage-Mode Data Communications
- Fully Configurable Dual-Rail Design Allows Each Port to Operate Over the Full 1.2-V to 3.6-V Power-Supply Range
- I_{off} Supports Partial-Power-Down Mode Operation
- I/Os Are 4.6-V Tolerant
- Latch-Up Performance Exceeds 100 mA Per JESD 78, Class II
- ESD Protection Exceeds JESD 22
 - 8000-V Human-Body Model (A114-A)
 - 200-V Machine Model (A115-A)
 - 1000-V Charged-Device Model (C101)

description/ordering information

This 32-bit noninverting bus transceiver uses two separate configurable power-supply rails. The SN74AVC32T245 is optimized to operate with V_{CCA}/V_{CCB} set at 1.4 V to 3.6 V. It is operational with V_{CCA}/V_{CCB} as low as 1.2 V. The A port is designed to track V_{CCA} . V_{CCA} accepts any supply voltage from 1.2 V to 3.6 V. The B port is designed to track V_{CCB} . V_{CCB} accepts any supply voltage from 1.2 V to 3.6 V. This allows for universal low-voltage bidirectional translation between any of the 1.2-V, 1.5-V, 1.8-V, 2.5-V, and 3.3-V voltage nodes.

The SN74AVC32T245 is designed for asynchronous communication between data buses. The device transmits data from the A bus to the B bus or from the B bus to the A bus, depending on the logic level at the direction-control (DIR) input. The output-enable (\overline{OE}) input can be used to disable the outputs so the buses are effectively isolated.

The SN74AVC32T245 is designed so that the control pins (1DIR, 2DIR, 3DIR, 4DIR, $\overline{1OE}$, $\overline{2OE}$, $\overline{3OE}$, and $\overline{4OE}$) are supplied by V_{CCA} .

This device is fully specified for partial-power-down applications using I_{off} . The I_{off} circuitry disables the outputs, preventing damaging current backflow through the device when it is powered down.

The V_{CC} isolation feature ensures that if either V_{CC} input is at GND, then both ports are in the high-impedance state.

To ensure the high-impedance state during power up or power down, \overline{OE} should be tied to V_{CC} through a pullup resistor; the minimum value of the resistor is determined by the current-sinking capability of the driver.

ORDERING INFORMATION

TA	PACKAGE†		ORDERABLE PART NUMBER	TOP-SIDE MARKING
–40°C to 85°C	LFBGA – GKE	Tape and reel	SN74AVC32T245GKER	WF245
	LFBGA – ZKE (Pb-free)		SN74AVC32T245ZKER	

† Package drawings, standard packing quantities, thermal data, symbolization, and PCB design guidelines are available at www.ti.com/sc/package.



Please be aware that an important notice concerning availability, standard warranty, and use in critical applications of Texas Instruments semiconductor products and disclaimers thereto appears at the end of this data sheet.

Widebus+ is a trademark of Texas Instruments.

PRODUCTION DATA information is current as of publication date. Products conform to specifications per the terms of Texas Instruments standard warranty. Production processing does not necessarily include testing of all parameters.



Copyright © 2005, Texas Instruments Incorporated

SN74AVC32T245

32-BIT DUAL-SUPPLY BUS TRANSCEIVER

WITH CONFIGURABLE VOLTAGE TRANSLATION AND 3-STATE OUTPUTS

SCES553C – MAY 2004 – REVISED APRIL 2005

GKE OR ZKE PACKAGE (TOP VIEW)

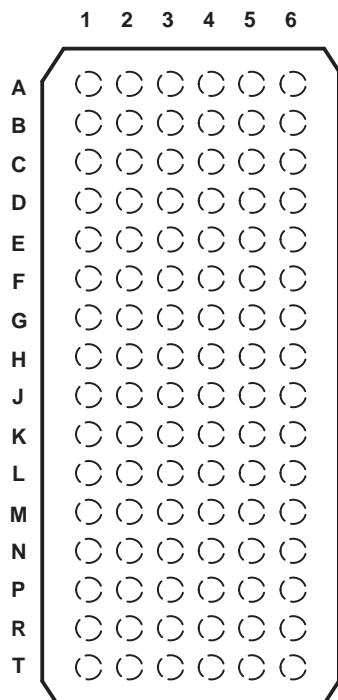

terminal assignments

	1	2	3	4	5	6
A	1B2	1B1	1DIR	$\overline{1OE}$	1A1	1A2
B	1B4	1B3	GND	GND	1A3	1A4
C	1B6	1B5	VCCB	VCCA	1A5	1A6
D	1B8	1B7	GND	GND	1A7	1A8
E	2B2	2B1	GND	GND	2A1	2A2
F	2B4	2B3	VCCB	VCCA	2A3	2A4
G	2B6	2B5	GND	GND	2A5	2A6
H	2B7	2B8	2DIR	$\overline{2OE}$	2A8	2A7
J	3B2	3B1	3DIR	$\overline{3OE}$	3A1	3A2
K	3B4	3B3	GND	GND	3A3	3A4
L	3B6	3B5	VCCB	VCCA	3A5	3A6
M	3B8	3B7	GND	GND	3A7	3A8
N	4B2	4B1	GND	GND	4A1	4A2
P	4B4	4B3	VCCB	VCCA	4A3	4A4
R	4B6	4B5	GND	GND	4A5	4A6
T	4B7	4B8	4DIR	$\overline{4OE}$	4A8	4A7

FUNCTION TABLE (each 8-bit section)

INPUTS		OPERATION
\overline{OE}	DIR	
L	L	B data to A bus
L	H	A data to B bus
H	X	Isolation

SN74AVC32T245

32-BIT DUAL-SUPPLY BUS TRANSCEIVER

WITH CONFIGURABLE VOLTAGE TRANSLATION AND 3-STATE OUTPUTS

SCE553C – MAY 2004 – REVISED APRIL 2005

absolute maximum ratings over operating free-air temperature range (unless otherwise noted)†

Supply voltage range, V_{CCA} and V_{CCB}	–0.5 V to 4.6 V
Input voltage range, V_I (see Note 1): I/O ports (A port)	–0.5 V to 4.6 V
I/O ports (B port)	–0.5 V to 4.6 V
Control inputs	–0.5 V to 4.6 V
Voltage range applied to any output in the high-impedance or power-off state, V_O	
(see Note 1): A port	–0.5 V to 4.6 V
B port	–0.5 V to 4.6 V
Voltage range applied to any output in the high or low state, V_O	
(see Notes 1 and 2): A port	–0.5 V to $V_{CCA} + 0.5$ V
B port	–0.5 V to $V_{CCB} + 0.5$ V
Input clamp current, I_{IK} ($V_I < 0$)	–50 mA
Output clamp current, I_{OK} ($V_O < 0$)	–50 mA
Continuous output current, I_O	±50 mA
Continuous current through each V_{CCA} , V_{CCB} , and GND	±100 mA
Package thermal impedance, θ_{JA} (see Note 3): GKE/ZKE package	40°C/W
Storage temperature range, T_{stg}	–65°C to 150°C

† Stresses beyond those listed under “absolute maximum ratings” may cause permanent damage to the device. These are stress ratings only, and functional operation of the device at these or any other conditions beyond those indicated under “recommended operating conditions” is not implied. Exposure to absolute-maximum-rated conditions for extended periods may affect device reliability.

- NOTES:
1. The input voltage and output negative-voltage ratings may be exceeded if the input and output current ratings are observed.
 2. The output positive-voltage rating may be exceeded up to 4.6 V maximum if the output current rating is observed.
 3. The package thermal impedance is calculated in accordance with JESD 51-7.



SN74AVC32T245
32-BIT DUAL-SUPPLY BUS TRANSCEIVER
WITH CONFIGURABLE VOLTAGE TRANSLATION AND 3-STATE OUTPUTS

SCES553C – MAY 2004 – REVISED APRIL 2005

recommended operating conditions (see Notes 4 through 6)

		V_{CCI}	V_{CCO}	MIN	MAX	UNIT
V_{CCA}	Supply voltage			1.2	3.6	V
V_{CCB}	Supply voltage			1.2	3.6	V
V_{IH}	High-level input voltage	Data inputs (see Note 7)	1.2 V to 1.95 V	$V_{CCI} \times 0.65$		V
			1.95 V to 2.7 V	1.6		
			2.7 V to 3.6 V	2		
V_{IL}	Low-level input voltage	Data inputs (see Note 7)	1.2 V to 1.95 V	$V_{CCI} \times 0.35$		V
			1.95 V to 2.7 V	0.7		
			2.7 V to 3.6 V	0.8		
V_{IH}	High-level input voltage	DIR (referenced to V_{CCA}) (see Note 8)	1.2 V to 1.95 V	$V_{CCA} \times 0.65$		V
			1.95 V to 2.7 V	1.6		
			2.7 V to 3.6 V	2		
V_{IL}	Low-level input voltage	DIR (referenced to V_{CCA}) (see Note 8)	1.2 V to 1.95 V	$V_{CCA} \times 0.35$		V
			1.95 V to 2.7 V	0.7		
			2.7 V to 3.6 V	0.8		
V_I	Input voltage			0	3.6	V
V_O	Output voltage	Active state		0	V_{CCO}	V
		3-state		0	3.6	
I_{OH}	High-level output current		1.2 V	-3		mA
			1.4 V to 1.6 V	-6		
			1.65 V to 1.95 V	-8		
			2.3 V to 2.7 V	-9		
			3 V to 3.6 V	-12		
I_{OL}	Low-level output current		1.2 V	3		mA
			1.4 V to 1.6 V	6		
			1.65 V to 1.95 V	8		
			2.3 V to 2.7 V	9		
			3 V to 3.6 V	12		
$\Delta t/\Delta v$	Input transition rise or fall rate				5	ns/V
T_A	Operating free-air temperature			-40	85	°C

- NOTES:
- V_{CCI} is the V_{CC} associated with the data input port.
 - V_{CCO} is the V_{CC} associated with the output port.
 - All unused data inputs of the device must be held at V_{CCI} or GND to ensure proper device operation. Refer to the TI application report, *Implications of Slow or Floating CMOS Inputs*, literature number SCBA004.
 - For V_{CCI} values not specified in the data sheet, V_{IH} min = $V_{CCI} \times 0.7$ V, V_{IL} max = $V_{CCI} \times 0.3$ V.
 - For V_{CCI} values not specified in the data sheet, V_{IH} min = $V_{CCA} \times 0.7$ V, V_{IL} max = $V_{CCA} \times 0.3$ V.



SN74AVC32T245

32-BIT DUAL-SUPPLY BUS TRANSCEIVER

WITH CONFIGURABLE VOLTAGE TRANSLATION AND 3-STATE OUTPUTS

SCES553C – MAY 2004 – REVISED APRIL 2005

electrical characteristics over recommended operating free-air temperature range (unless otherwise noted) (see Notes 9 and 10)

PARAMETER	TEST CONDITIONS		V _{CCA}	V _{CCB}	T _A = 25°C			-40°C TO 85°C		UNIT
					MIN	TYP	MAX	MIN	MAX	
V _{OH}		V _I = V _{IH}	1.2 V to 3.6 V	1.2 V to 3.6 V				V _{CCO} - 0.2 V		V
			1.2 V	1.2 V	0.95					
			1.4 V	1.4 V				1.05		
			1.65 V	1.65 V				1.2		
			2.3 V	2.3 V				1.75		
			3 V	3 V				2.3		
V _{OL}		V _I = V _{IL}	1.2 V to 3.6 V	1.2 V to 3.6 V				0.2		V
			1.2 V	1.2 V	0.15					
			1.4 V	1.4 V				0.35		
			1.65 V	1.65 V				0.45		
			2.3 V	2.3 V				0.55		
			3 V	3 V				0.7		
I _I	Control inputs	V _I = V _{CCA} or GND	1.2 V to 3.6 V	1.2 V to 3.6 V		±0.025	±0.25		±1	μA
I _{off}	A or B port	V _I or V _O = 0 to 3.6 V	0 V	0 to 3.6 V		±0.1	±2.5		±5	μA
	A or B port		0 to 3.6 V	0 V		±0.1	±2.5		±5	
I _{OZ} †	A or B port	V _O = V _{CCO} or GND, $\overline{OE} = V_{IH}$ V _I = V _{CCI} or GND,	3.6 V	3.6 V		±0.5	±2.5		±5	μA
I _{CCA}		V _I = V _{CCI} or GND, I _O = 0	1.2 V to 3.6 V	1.2 V to 3.6 V				50		μA
			0 V	3.6 V				-10		
			3.6 V	0 V				50		
I _{CCB}		V _I = V _{CCI} or GND, I _O = 0	1.2 V to 3.6 V	1.2 V to 3.6 V				50		μA
			0 V	3.6 V				50		
			3.6 V	0 V				-10		
I _{CCA} + I _{CCB}		V _I = V _{CCI} or GND, I _O = 0	1.2 V to 3.6 V	1.2 V to 3.6 V				90		μA
C _i	Control inputs	V _I = 3.3 V or GND	3.3 V	3.3 V		3.5				pF
C _{io}	A or B port	V _O = 3.3 V or GND	3.3 V	3.3 V		7				pF

† For I/O ports, the parameter I_{OZ} includes the input leakage current.

NOTES: 9. V_{CCO} is the V_{CC} associated with the output port.

10. V_{CCI} is the V_{CC} associated with the input port.



SN74AVC32T245
32-BIT DUAL-SUPPLY BUS TRANSCEIVER
WITH CONFIGURABLE VOLTAGE TRANSLATION AND 3-STATE OUTPUTS

SCES553C – MAY 2004 – REVISED APRIL 2005

switching characteristics over recommended operating free-air temperature range,
 $V_{CCA} = 1.2\text{ V}$ (see Figure 1)

PARAMETER	FROM (INPUT)	TO (OUTPUT)	$V_{CCB} = 1.2\text{ V}$	$V_{CCB} = 1.5\text{ V}$	$V_{CCB} = 1.8\text{ V}$	$V_{CCB} = 2.5\text{ V}$	$V_{CCB} = 3.3\text{ V}$	UNIT
			TYP	TYP	TYP	TYP	TYP	
t_{PLH}	A	B	4.1	3.3	3	2.8	3.2	ns
t_{PHL}			4.1	3.3	3	2.8	3.2	
t_{PLH}	B	A	4.4	4	3.8	3.6	3.5	ns
t_{PHL}			4.4	4	3.8	3.6	3.5	
t_{PZH}	\overline{OE}	A	6.4	6.4	6.4	6.4	6.4	ns
t_{PZL}			6.4	6.4	6.4	6.4	6.4	
t_{PZH}	\overline{OE}	B	6	4.6	4	3.4	3.2	ns
t_{PZL}			6	4.6	4	3.4	3.2	
t_{PHZ}	\overline{OE}	A	6.6	6.6	6.6	6.6	6.8	ns
t_{PLZ}			6.6	6.6	6.6	6.6	6.8	
t_{PHZ}	\overline{OE}	B	6	4.9	4.9	4.2	5.3	ns
t_{PLZ}			6	4.9	4.9	4.2	5.3	

switching characteristics over recommended operating free-air temperature range,
 $V_{CCA} = 1.5\text{ V} \pm 0.1\text{ V}$ (see Figure 1)

PARAMETER	FROM (INPUT)	TO (OUTPUT)	$V_{CCB} = 1.2\text{ V}$	$V_{CCB} = 1.5\text{ V} \pm 0.1\text{ V}$		$V_{CCB} = 1.8\text{ V} \pm 0.15\text{ V}$		$V_{CCB} = 2.5\text{ V} \pm 0.2\text{ V}$		$V_{CCB} = 3.3\text{ V} \pm 0.3\text{ V}$		UNIT
			TYP	MIN	MAX	MIN	MAX	MIN	MAX	MIN	MAX	
t_{PLH}	A	B	3.6	0.5	6.2	0.5	5.2	0.5	4.1	0.5	3.7	ns
t_{PHL}			3.6	0.5	6.2	0.5	5.2	0.5	4.1	0.5	3.7	
t_{PLH}	B	A	3.3	0.5	6.2	0.5	5.9	0.5	5.6	0.5	5.5	ns
t_{PHL}			3.3	0.5	6.2	0.5	5.9	0.5	5.6	0.5	5.5	
t_{PZH}	\overline{OE}	A	4.3	1	10.1	1	10.1	1	10.1	1	10.1	ns
t_{PZL}			4.3	1	10.1	1	10.1	1	10.1	1	10.1	
t_{PZH}	\overline{OE}	B	5.6	1	10.1	0.5	8.1	0.5	5.9	0.5	5.2	ns
t_{PZL}			5.6	1	10.1	0.5	8.1	0.5	5.9	0.5	5.2	
t_{PHZ}	\overline{OE}	A	4.5	1.5	9.1	1.5	9.1	1.5	9.1	1.5	9.1	ns
t_{PLZ}			4.5	1.5	9.1	1.5	9.1	1.5	9.1	1.5	9.1	
t_{PHZ}	\overline{OE}	B	5.5	1.5	8.7	1.5	7.5	1	6.5	1	6.3	ns
t_{PLZ}			5.5	1.5	8.7	1.5	7.5	1	6.5	1	6.3	

SN74AVC32T245

32-BIT DUAL-SUPPLY BUS TRANSCEIVER

WITH CONFIGURABLE VOLTAGE TRANSLATION AND 3-STATE OUTPUTS

SCES553C – MAY 2004 – REVISED APRIL 2005

switching characteristics over recommended operating free-air temperature range,
 $V_{CCA} = 1.8\text{ V} \pm 0.15\text{ V}$ (see Figure 1)

PARAMETER	FROM (INPUT)	TO (OUTPUT)	$V_{CCB} = 1.2\text{ V}$	$V_{CCB} = 1.5\text{ V} \pm 0.1\text{ V}$		$V_{CCB} = 1.8\text{ V} \pm 0.15\text{ V}$		$V_{CCB} = 2.5\text{ V} \pm 0.2\text{ V}$		$V_{CCB} = 3.3\text{ V} \pm 0.3\text{ V}$		UNIT
			TYP	MIN	MAX	MIN	MAX	MIN	MAX	MIN	MAX	
t_{PLH}	A	B	3.4	0.5	5.9	0.5	4.8	0.5	3.7	0.5	3.3	ns
t_{PHL}			3.4	0.5	5.9	0.5	4.8	0.5	3.7	0.5	3.3	
t_{PLH}	B	A	3	0.5	5.2	0.5	4.8	0.5	4.5	0.5	4.4	ns
t_{PHL}			3	0.5	5.2	0.5	4.8	0.5	4.5	0.5	4.4	
t_{PZH}	\overline{OE}	A	3.4	1	7.8	1	7.8	1	7.8	1	7.8	ns
t_{PZL}			3.4	1	7.8	1	7.8	1	7.8	1	7.8	
t_{PZH}	\overline{OE}	B	5.4	1	9.2	0.5	7.4	0.5	5.3	0.5	4.5	ns
t_{PZL}			5.4	1	9.2	0.5	7.4	0.5	5.3	0.5	4.5	
t_{PHZ}	\overline{OE}	A	4.2	1.5	7.7	1.5	7.7	1.5	7.7	1.5	7.7	ns
t_{PLZ}			4.2	1.5	7.7	1.5	7.7	1.5	7.7	1.5	7.7	
t_{PHZ}	\overline{OE}	B	5.2	1.5	8.4	1.5	7.1	1	5.9	1	5.7	ns
t_{PLZ}			5.2	1.5	8.4	1.5	7.1	1	5.9	1	5.7	

switching characteristics over recommended operating free-air temperature range,
 $V_{CCA} = 2.5\text{ V} \pm 0.2\text{ V}$ (see Figure 1)

PARAMETER	FROM (INPUT)	TO (OUTPUT)	$V_{CCB} = 1.2\text{ V}$	$V_{CCB} = 1.5\text{ V} \pm 0.1\text{ V}$		$V_{CCB} = 1.8\text{ V} \pm 0.15\text{ V}$		$V_{CCB} = 2.5\text{ V} \pm 0.2\text{ V}$		$V_{CCB} = 3.3\text{ V} \pm 0.3\text{ V}$		UNIT
			TYP	MIN	MAX	MIN	MAX	MIN	MAX	MIN	MAX	
t_{PLH}	A	B	3.2	0.5	5.6	0.5	4.5	0.5	3.3	0.5	2.8	ns
t_{PHL}			3.2	0.5	5.6	0.5	4.5	0.5	3.3	0.5	2.8	
t_{PLH}	B	A	2.6	0.5	4.1	0.5	3.7	0.5	3.3	0.5	3.2	ns
t_{PHL}			2.6	0.5	4.1	0.5	3.7	0.5	3.3	0.5	3.2	
t_{PZH}	\overline{OE}	A	2.5	0.5	5.3	0.5	5.3	0.5	5.3	0.5	5.3	ns
t_{PZL}			2.5	0.5	5.3	0.5	5.3	0.5	5.3	0.5	5.3	
t_{PZH}	\overline{OE}	B	5.2	0.5	9.4	0.5	7.3	0.5	5.1	0.5	4.5	ns
t_{PZL}			5.2	0.5	9.4	0.5	7.3	0.5	5.1	0.5	4.5	
t_{PHZ}	\overline{OE}	A	3	1	6.1	1	6.1	1	6.1	1	6.1	ns
t_{PLZ}			3	1	6.1	1	6.1	1	6.1	1	6.1	
t_{PHZ}	\overline{OE}	B	5	1	7.9	1	6.6	1	6.1	1	5.2	ns
t_{PLZ}			5	1	7.9	1	6.6	1	6.1	1	5.2	



SN74AVC32T245
32-BIT DUAL-SUPPLY BUS TRANSCEIVER
WITH CONFIGURABLE VOLTAGE TRANSLATION AND 3-STATE OUTPUTS

SCES553C – MAY 2004 – REVISED APRIL 2005

switching characteristics over recommended operating free-air temperature range,
 $V_{CCA} = 3.3 \text{ V} \pm 0.3 \text{ V}$ (see Figure 1)

PARAMETER	FROM (INPUT)	TO (OUTPUT)	$V_{CCB} = 1.2 \text{ V}$	$V_{CCB} = 1.5 \text{ V} \pm 0.1 \text{ V}$		$V_{CCB} = 1.8 \text{ V} \pm 0.15 \text{ V}$		$V_{CCB} = 2.5 \text{ V} \pm 0.2 \text{ V}$		$V_{CCB} = 3.3 \text{ V} \pm 0.3 \text{ V}$		UNIT
			TYP	MIN	MAX	MIN	MAX	MIN	MAX	MIN	MAX	
t_{PLH}	A	B	3.2	0.5	5.5	0.5	4.4	0.5	3.2	0.5	2.7	ns
t_{PHL}			3.2	0.5	5.5	0.5	4.4	0.5	3.2	0.5	2.7	
t_{PLH}	B	A	2.8	0.5	3.7	0.5	3.3	0.5	2.8	0.5	2.7	ns
t_{PHL}			2.8	0.5	3.7	0.5	3.3	0.5	2.8	0.5	2.7	
t_{PZH}	\overline{OE}	A	2.2	0.5	4.3	0.5	4.2	0.5	4.1	0.5	4	ns
t_{PZL}			2.2	0.5	4.3	0.5	4.2	0.5	4.1	0.5	4	
t_{PZH}	\overline{OE}	B	5.1	0.5	9.3	0.5	7.2	0.5	4.9	0.5	4	ns
t_{PZL}			5.1	0.5	9.3	0.5	7.2	0.5	4.9	0.5	4	
t_{PHZ}	\overline{OE}	A	3.4	0.5	5	0.5	5	0.5	5	0.5	5	ns
t_{PLZ}			3.4	0.5	5	0.5	5	0.5	5	0.5	5	
t_{PHZ}	\overline{OE}	B	4.9	1	7.7	1	6.5	1	5.2	0.5	5	ns
t_{PLZ}			4.9	1	7.7	1	6.5	1	5.2	0.5	5	

operating characteristics, $T_A = 25^\circ\text{C}$

PARAMETER			TEST CONDITIONS	$V_{CCA} = V_{CCB} = 1.2 \text{ V}$	$V_{CCA} = V_{CCB} = 1.5 \text{ V}$	$V_{CCA} = V_{CCB} = 1.8 \text{ V}$	$V_{CCA} = V_{CCB} = 2.5 \text{ V}$	$V_{CCA} = V_{CCB} = 3.3 \text{ V}$	UNIT
				TYP	TYP	TYP	TYP	TYP	
C_{pdA}^\dagger	A to B	Outputs enabled	$C_L = 0,$ $f = 10 \text{ MHz},$ $t_r = t_f = 1 \text{ ns}$	1	1	1	1	2	pF
		Outputs disabled		1	1	1	1	1	
	B to A	Outputs enabled		13	13	14	15	16	
		Outputs disabled		1	1	1	1	1	
C_{pdB}^\dagger	A to B	Outputs enabled	$C_L = 0,$ $f = 10 \text{ MHz},$ $t_r = t_f = 1 \text{ ns}$	13	13	14	15	16	pF
		Outputs disabled		1	1	1	1	1	
	B to A	Outputs enabled		1	1	1	1	2	
		Outputs disabled		1	1	1	1	1	

† Power-dissipation capacitance per transceiver



SN74AVC32T245
32-BIT DUAL-SUPPLY BUS TRANSCEIVER
WITH CONFIGURABLE VOLTAGE TRANSLATION AND 3-STATE OUTPUTS

SCES553C – MAY 2004 – REVISED APRIL 2005

typical total static power consumption ($I_{CCA} + I_{CCB}$)

Table 1

V _{CCB}	V _{CCA}						UNIT
	0 V	1.2 V	1.5 V	1.8 V	2.5 V	3.3 V	
0 V	0	<1	<1	<1	<1	<1	μA
1.2 V	<1	<2	<2	<2	<2	2	
1.5 V	<1	<2	<2	<2	<2	2	
1.8 V	<1	<2	<2	<2	<2	<2	
2.5 V	<1	2	<2	<2	<2	<2	
3.3 V	<1	2	<2	<2	<2	<2	

SN74AVC32T245
32-BIT DUAL-SUPPLY BUS TRANSCEIVER
WITH CONFIGURABLE VOLTAGE TRANSLATION AND 3-STATE OUTPUTS

SCES553C – MAY 2004 – REVISED APRIL 2005

TYPICAL CHARACTERISTICS

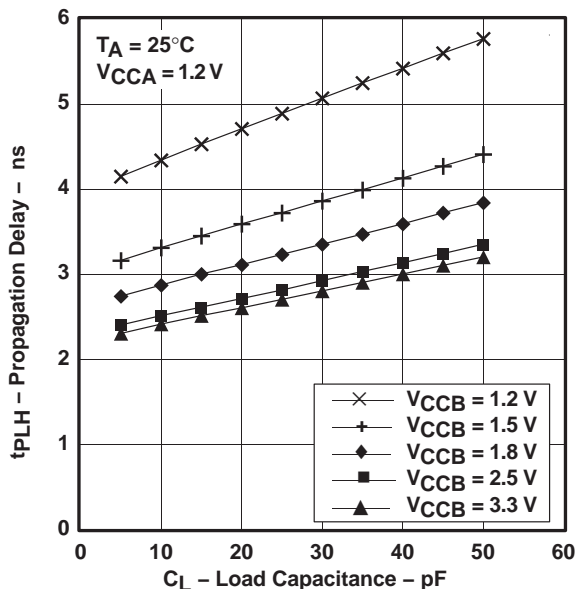

Figure 1

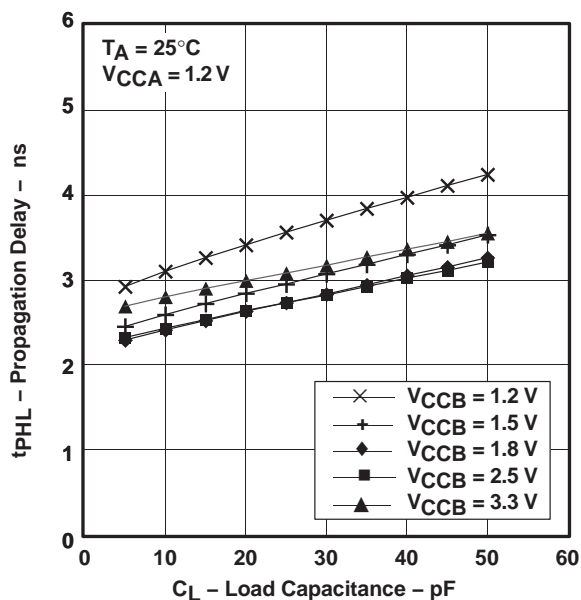

Figure 2

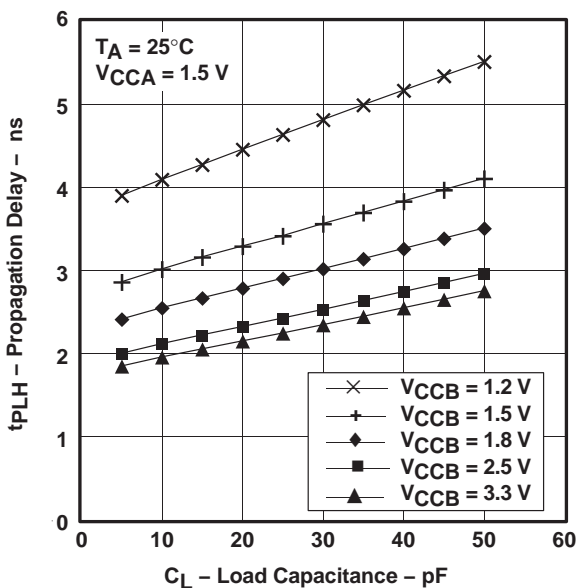

Figure 3

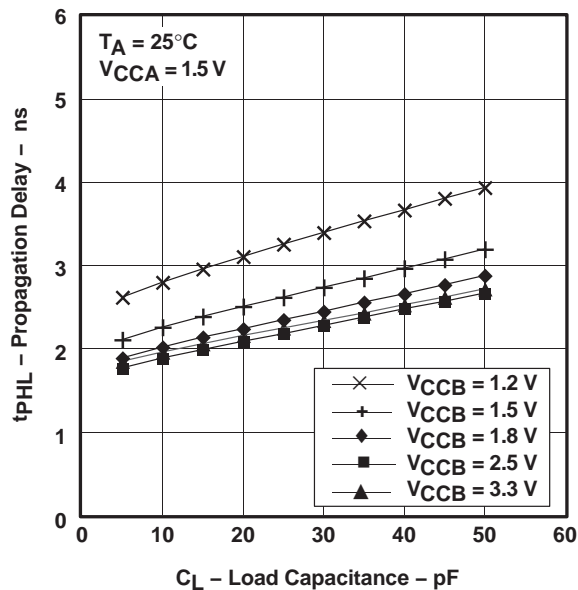

Figure 4

TYPICAL CHARACTERISTICS

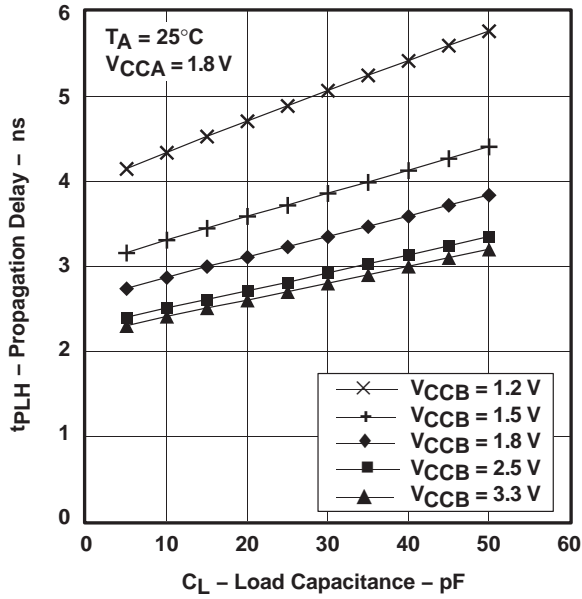

Figure 5

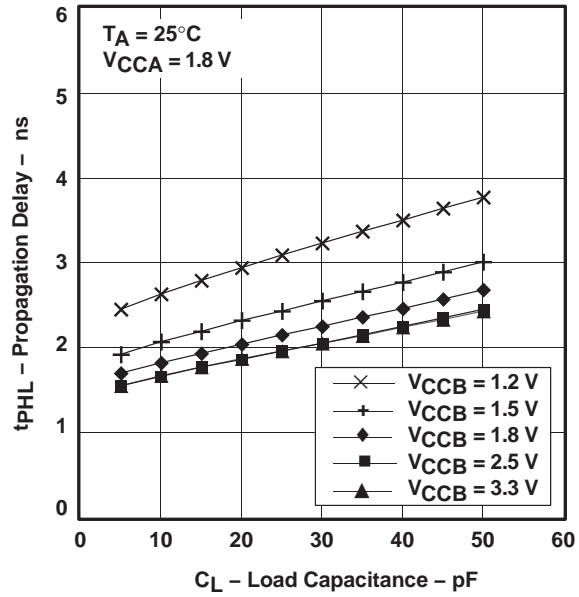

Figure 6

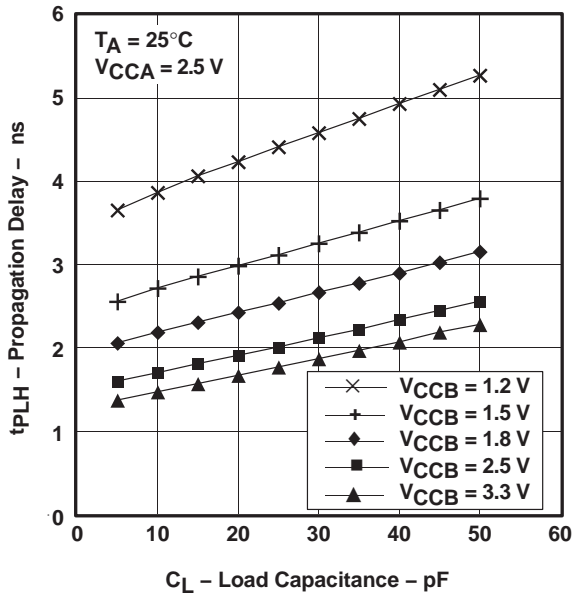

Figure 7

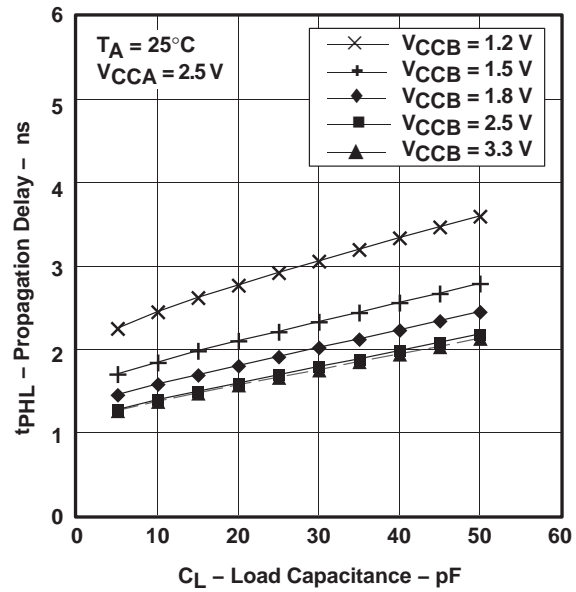

Figure 8

SN74AVC32T245
32-BIT DUAL-SUPPLY BUS TRANSCEIVER
WITH CONFIGURABLE VOLTAGE TRANSLATION AND 3-STATE OUTPUTS

SCES553C – MAY 2004 – REVISED APRIL 2005

TYPICAL CHARACTERISTICS

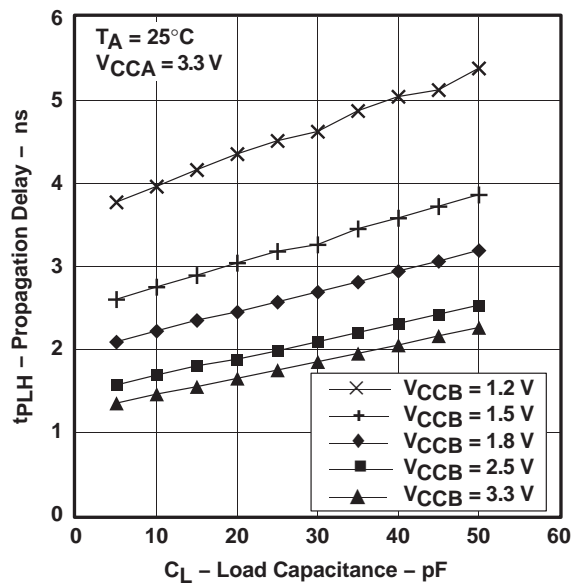

Figure 9

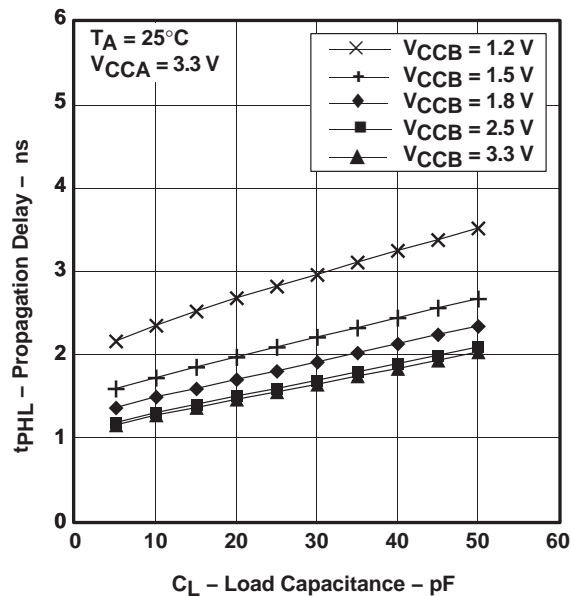
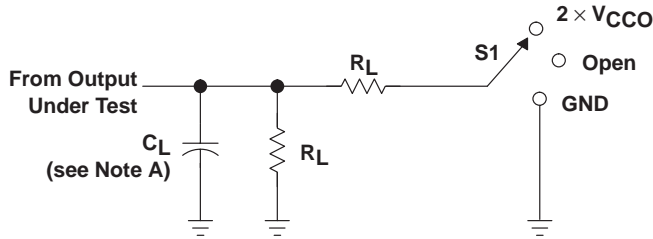

Figure 10

PARAMETER MEASUREMENT INFORMATION



LOAD CIRCUIT

TEST	S1
t_{pd}	Open
t_{PLZ}/t_{PZL}	$2 \times V_{CCO}$
t_{PHZ}/t_{PZH}	GND

V_{CCO}	C_L	R_L	V_{TP}
1.2 V	15 pF	2 k Ω	0.1 V
1.5 V \pm 0.1 V	15 pF	2 k Ω	0.1 V
1.8 V \pm 0.15 V	15 pF	2 k Ω	0.15 V
2.5 V \pm 0.2 V	15 pF	2 k Ω	0.15 V
3.3 V \pm 0.3 V	15 pF	2 k Ω	0.3 V

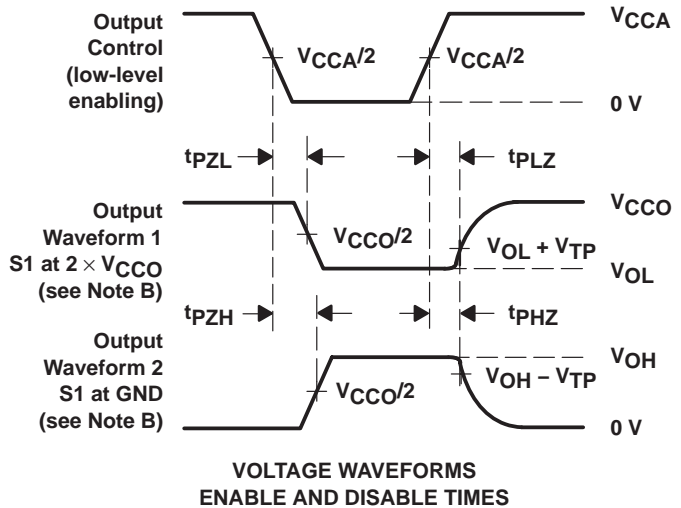
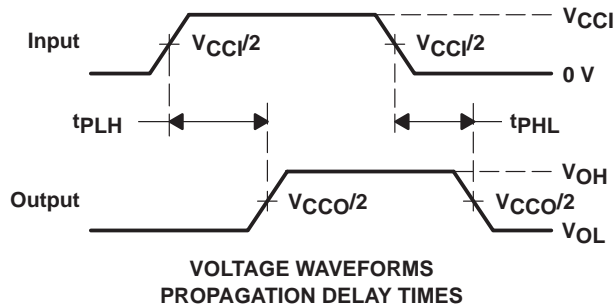
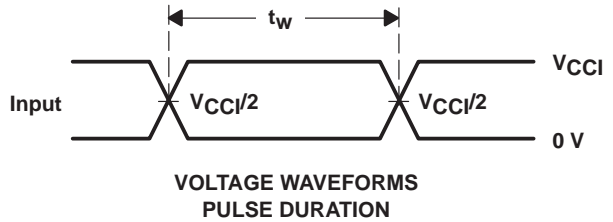

- NOTES:
- A. C_L includes probe and jig capacitance.
 - B. Waveform 1 is for an output with internal conditions such that the output is low, except when disabled by the output control. Waveform 2 is for an output with internal conditions such that the output is high, except when disabled by the output control.
 - C. All input pulses are supplied by generators having the following characteristics: $PRR \leq 10$ MHz, $Z_O = 50 \Omega$, $dv/dt \geq 1$ V/ns.
 - D. The outputs are measured one at a time, with one transition per measurement.
 - E. t_{PLZ} and t_{PHZ} are the same as t_{dis} .
 - F. t_{PZL} and t_{PZH} are the same as t_{en} .
 - G. t_{PLH} and t_{PHL} are the same as t_{pd} .
 - H. V_{CCI} is the V_{CC} associated with the input port.
 - I. V_{CCO} is the V_{CC} associated with the output port.

Figure 11. Load Circuit and Voltage Waveforms

PACKAGING INFORMATION

Orderable Device	Status ⁽¹⁾	Package Type	Package Drawing	Pins	Package Qty	Eco Plan ⁽²⁾	Lead/Ball Finish	MSL Peak Temp ⁽³⁾
SN74AVC32T245GKER	ACTIVE	LFBGA	GKE	96	1000	TBD	SNPB	Level-3-220C-168 HR
SN74AVC32T245ZKER	ACTIVE	LFBGA	ZKE	96	1000	Green (RoHS & no Sb/Br)	SNAGCU	Level-3-250C-168 HR

⁽¹⁾ The marketing status values are defined as follows:

ACTIVE: Product device recommended for new designs.

LIFEBUY: TI has announced that the device will be discontinued, and a lifetime-buy period is in effect.

NRND: Not recommended for new designs. Device is in production to support existing customers, but TI does not recommend using this part in a new design.

PREVIEW: Device has been announced but is not in production. Samples may or may not be available.

OBSELETE: TI has discontinued the production of the device.

⁽²⁾ Eco Plan - The planned eco-friendly classification: Pb-Free (RoHS) or Green (RoHS & no Sb/Br) - please check <http://www.ti.com/productcontent> for the latest availability information and additional product content details.

TBD: The Pb-Free/Green conversion plan has not been defined.

Pb-Free (RoHS): TI's terms "Lead-Free" or "Pb-Free" mean semiconductor products that are compatible with the current RoHS requirements for all 6 substances, including the requirement that lead not exceed 0.1% by weight in homogeneous materials. Where designed to be soldered at high temperatures, TI Pb-Free products are suitable for use in specified lead-free processes.

Green (RoHS & no Sb/Br): TI defines "Green" to mean Pb-Free (RoHS compatible), and free of Bromine (Br) and Antimony (Sb) based flame retardants (Br or Sb do not exceed 0.1% by weight in homogeneous material)

⁽³⁾ MSL, Peak Temp. -- The Moisture Sensitivity Level rating according to the JEDEC industry standard classifications, and peak solder temperature.

Important Information and Disclaimer:The information provided on this page represents TI's knowledge and belief as of the date that it is provided. TI bases its knowledge and belief on information provided by third parties, and makes no representation or warranty as to the accuracy of such information. Efforts are underway to better integrate information from third parties. TI has taken and continues to take reasonable steps to provide representative and accurate information but may not have conducted destructive testing or chemical analysis on incoming materials and chemicals. TI and TI suppliers consider certain information to be proprietary, and thus CAS numbers and other limited information may not be available for release.

In no event shall TI's liability arising out of such information exceed the total purchase price of the TI part(s) at issue in this document sold by TI to Customer on an annual basis.

GKE (R-PBGA-N96)

PLASTIC BALL GRID ARRAY

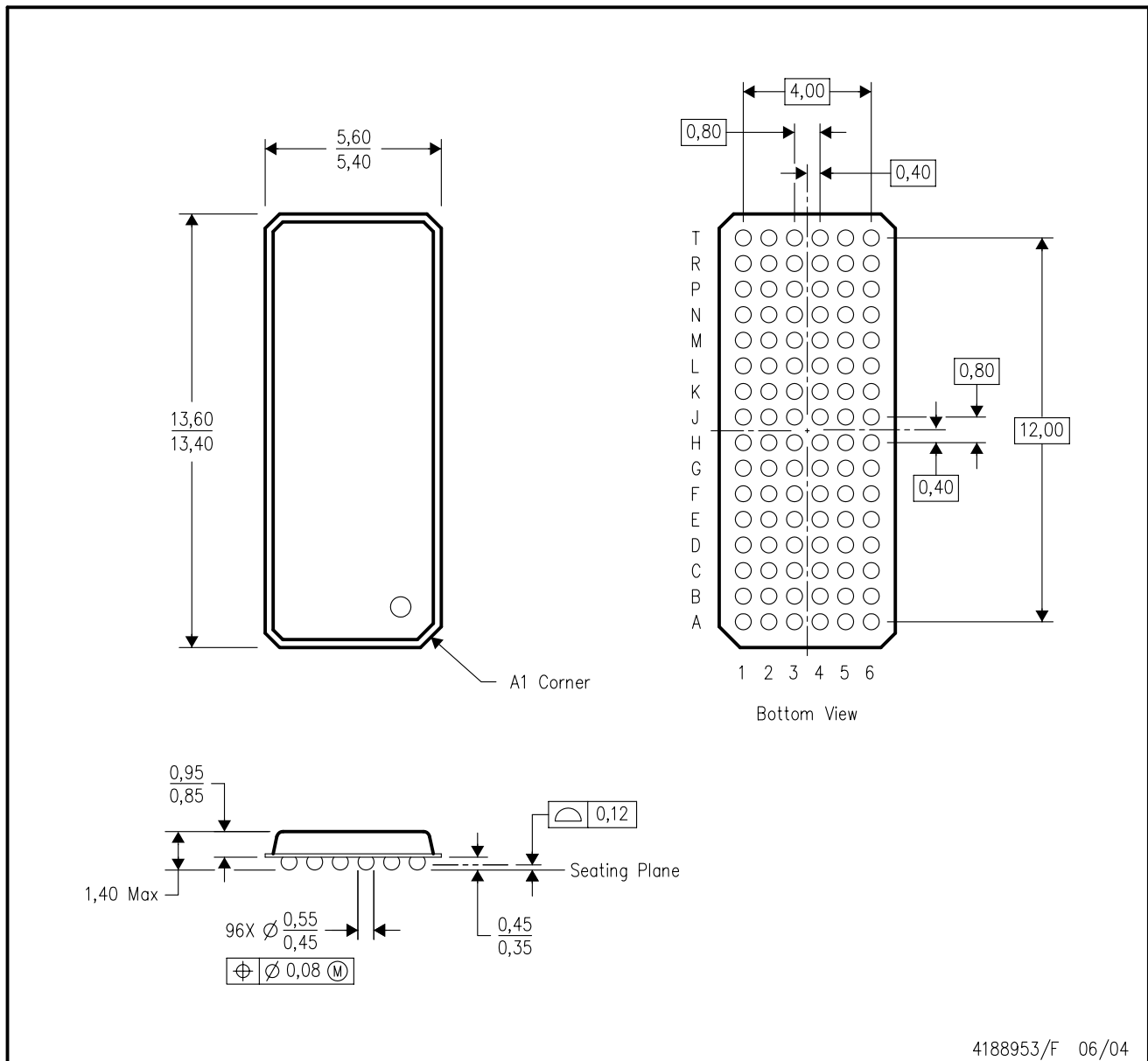

4188953/F 06/04

- NOTES:
- A. All linear dimensions are in millimeters.
 - B. This drawing is subject to change without notice.
 - C. Falls within JEDEC MO-205 variation CC.
 - D. This package is tin-lead (SnPb). Refer to the 96 ZKE package (drawing 4204493) for lead-free.

ZKE (R-PBGA-N96)

PLASTIC BALL GRID ARRAY

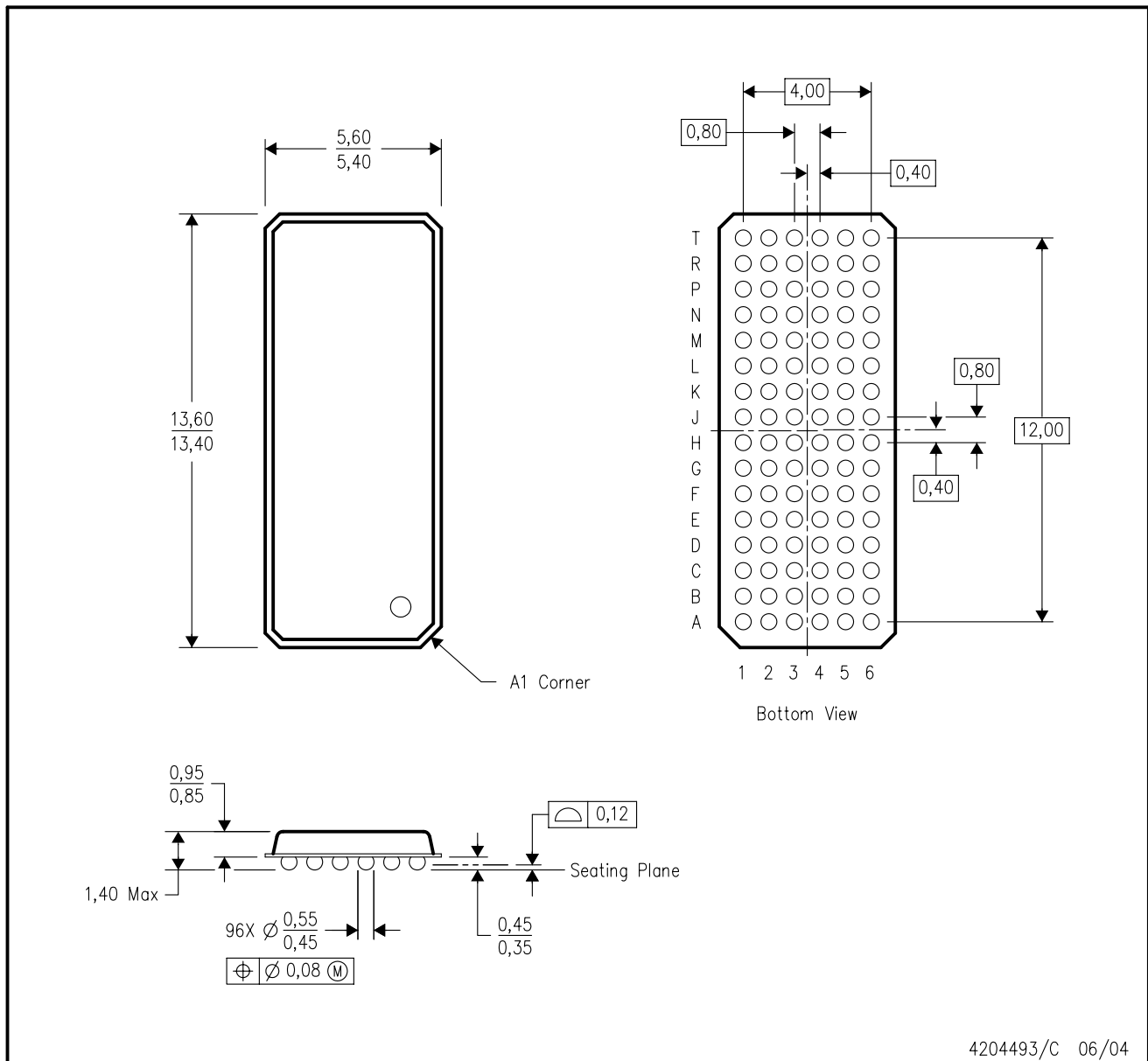

4204493/C 06/04

- NOTES:
- A. All linear dimensions are in millimeters.
 - B. This drawing is subject to change without notice.
 - C. Falls within JEDEC MO-205 variation CC.
 - D. This package is lead-free. Refer to the 96 GKE package (drawing 4188953) for tin-lead (SnPb).

IMPORTANT NOTICE

Texas Instruments Incorporated and its subsidiaries (TI) reserve the right to make corrections, modifications, enhancements, improvements, and other changes to its products and services at any time and to discontinue any product or service without notice. Customers should obtain the latest relevant information before placing orders and should verify that such information is current and complete. All products are sold subject to TI's terms and conditions of sale supplied at the time of order acknowledgment.

TI warrants performance of its hardware products to the specifications applicable at the time of sale in accordance with TI's standard warranty. Testing and other quality control techniques are used to the extent TI deems necessary to support this warranty. Except where mandated by government requirements, testing of all parameters of each product is not necessarily performed.

TI assumes no liability for applications assistance or customer product design. Customers are responsible for their products and applications using TI components. To minimize the risks associated with customer products and applications, customers should provide adequate design and operating safeguards.

TI does not warrant or represent that any license, either express or implied, is granted under any TI patent right, copyright, mask work right, or other TI intellectual property right relating to any combination, machine, or process in which TI products or services are used. Information published by TI regarding third-party products or services does not constitute a license from TI to use such products or services or a warranty or endorsement thereof. Use of such information may require a license from a third party under the patents or other intellectual property of the third party, or a license from TI under the patents or other intellectual property of TI.

Reproduction of information in TI data books or data sheets is permissible only if reproduction is without alteration and is accompanied by all associated warranties, conditions, limitations, and notices. Reproduction of this information with alteration is an unfair and deceptive business practice. TI is not responsible or liable for such altered documentation.

Resale of TI products or services with statements different from or beyond the parameters stated by TI for that product or service voids all express and any implied warranties for the associated TI product or service and is an unfair and deceptive business practice. TI is not responsible or liable for any such statements.

Following are URLs where you can obtain information on other Texas Instruments products and application solutions:

Products		Applications	
Amplifiers	amplifier.ti.com	Audio	www.ti.com/audio
Data Converters	dataconverter.ti.com	Automotive	www.ti.com/automotive
DSP	dsp.ti.com	Broadband	www.ti.com/broadband
Interface	interface.ti.com	Digital Control	www.ti.com/digitalcontrol
Logic	logic.ti.com	Military	www.ti.com/military
Power Mgmt	power.ti.com	Optical Networking	www.ti.com/opticalnetwork
Microcontrollers	microcontroller.ti.com	Security	www.ti.com/security
		Telephony	www.ti.com/telephony
		Video & Imaging	www.ti.com/video
		Wireless	www.ti.com/wireless

Mailing Address: Texas Instruments
Post Office Box 655303 Dallas, Texas 75265

Copyright © Each Manufacturing Company.

All Datasheets cannot be modified without permission.

This datasheet has been download from :

www.AllDataSheet.com

100% Free DataSheet Search Site.

Free Download.

No Register.

Fast Search System.

www.AllDataSheet.com