



Dual, VARIABLE GAIN AMPLIFIER with Input Buffer

FEATURES

- **GAIN RANGE:** up to 43dB
- **30MHz BANDWIDTH**
- **LOW CROSSTALK:** 65dB at Max Gain, 5MHz
- **HIGH-SPEED VARIABLE GAIN ADJUST**
- **POWER SHUTDOWN MODE**
- **HIGH IMPEDANCE INPUT BUFFER**

APPLICATIONS

- **ULTRASOUND SYSTEMS**
- **WIRELESS RECEIVERS**
- **TEST EQUIPMENT**
- **RADAR**

DESCRIPTION

The VCA2618 is a highly integrated, dual receive channel, Variable Gain Amplifier (VGA) with analog gain control.

The VCA2618's VGA section consists of two parts: the Voltage Controlled Attenuator (VCA) and the Programmable Gain Amplifier (PGA). The gain and gain range of the PGA can be digitally programmed. The combination of these two programmable elements results in a variable gain ranging from 0dB up to a maximum gain as defined by the user through external connections. The single-ended unity gain input buffer provides predictable high input impedance. The output of the VGA can be used in either a single-ended or differential mode to drive high-performance Analog-to-Digital (A/D) converters. A separate power-down pin reduces power consumption.

The VCA2618 also features low crosstalk and outstanding distortion performance. The combination of low noise and gain range programmability make the VCA2618 a versatile building block in a number of applications where noise performance is critical. The VCA2618 is available in a TQFP-32 package.

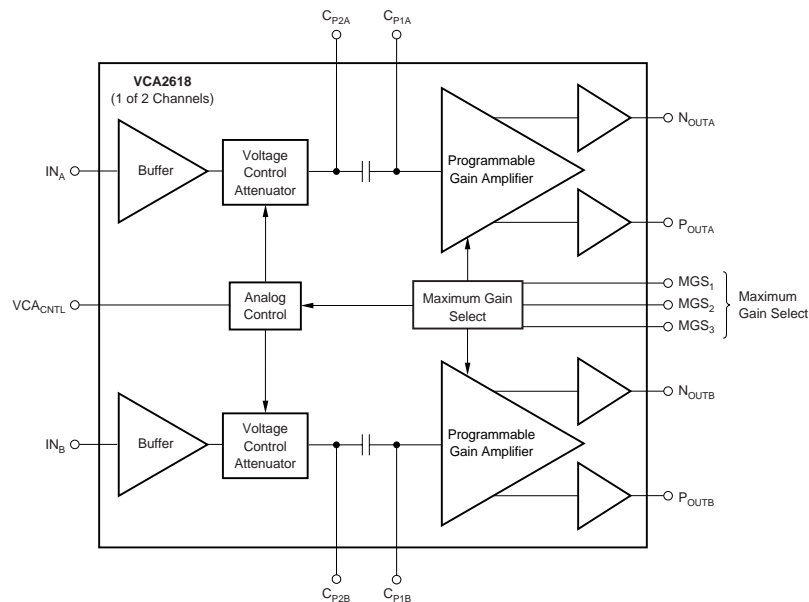

Please be aware that an important notice concerning availability, standard warranty, and use in critical applications of Texas Instruments semiconductor products and disclaimers thereto appears at the end of this data sheet.

All trademarks are the property of their respective owners.

PRODUCTION DATA information is current as of publication date. Products conform to specifications per the terms of Texas Instruments standard warranty. Production processing does not necessarily include testing of all parameters.



ABSOLUTE MAXIMUM RATINGS⁽¹⁾

Power Supply (+V _S)	+6V
Analog Input	-0.3V to (+V _S + 0.3V)
Logic Input	-0.3V to (+V _S + 0.3V)
Case Temperature	+100°C
Junction Temperature	+150°C
Storage Temperature	-40°C to +150°C

NOTE: (1) Stresses above those listed under "Absolute Maximum Ratings" may cause permanent damage to the device. Exposure to absolute maximum conditions for extended periods may affect device reliability.



ELECTROSTATIC DISCHARGE SENSITIVITY

This integrated circuit can be damaged by ESD. Texas Instruments recommends that all integrated circuits be handled with appropriate precautions. Failure to observe proper handling and installation procedures can cause damage.

ESD damage can range from subtle performance degradation to complete device failure. Precision integrated circuits may be more susceptible to damage because very small parametric changes could cause the device not to meet its published specifications.

PACKAGE/ORDERING INFORMATION

PRODUCT	PACKAGE-LEAD	PACKAGE DESIGNATOR ⁽¹⁾	SPECIFIED TEMPERATURE RANGE	PACKAGE MARKING	ORDERING NUMBER	TRANSPORT MEDIA, QUANTITY
VCA2618Y	TQFP-32 Surface-Mount	PBS	-40°C to +85°C	VCA2618Y	VCA2618YT	Tape and Reel, 250
"	"	"	"	"	VCA2618YR	Tape and Reel, 2000

NOTE: (1) For the most current specifications and package information, refer to our web site at www.ti.com.

ELECTRICAL CHARACTERISTICS

At T_A = +25°C, V_{DD} = 5V, load resistance = 500Ω on each output to ground differential output (2V_{PP}), MGS = 111, and f_{IN} = 5MHz, unless otherwise noted.

PARAMETER	CONDITIONS	VCA2618Y			UNITS
		MIN	TYP	MAX	
BUFFER					
Input Resistance			600		kΩ
Input Capacitance			5		pF
Input Bias Current			1		nA
Maximum Input Voltage			1		V _{PP}
Input Voltage Noise	PGA Gain = 45dB, R _S = 50Ω		5.4		nV/√Hz
Input Current Noise	Independent of Gain		350		fA/√Hz
Noise Figure	R _F = 550Ω, PGA Gain = 45dB, R _S = 75Ω		13		dB
Bandwidth			100		MHz
PROGRAMMABLE VARIABLE GAIN AMPLIFIER					
Peak Input Voltage			1		V _{PP}
-3dB Bandwidth			30		MHz
Slew Rate			300		V/μs
Output Signal Range	R _L ≥ 500Ω Each Side to Ground		2.5 ±1		V
Output Impedance			1		Ω
Output Short-Circuit Current			±40		mA
3rd-Harmonic Distortion	V _{OUT} = 2V _{PP} , VCA _{CNTL} = 3.0V	-45	-50		dBc
2nd-Harmonic Distortion	V _{OUT} = 2V _{PP} , VCA _{CNTL} = 3.0V	-42	-50		dBc
2nd-Harmonic Distortion	V _{OUT} = 2V _{PP} , VCA _{CNTL} = 3.0V, MGS = 011		-60		dBc
Overload Performance (2nd-Harmonic Distortion)	Input Signal = 1V _{PP} , VCA _{CNTL} = 2V		-40 to -45		dB
Time Delay			5		ns
IMD, 2-Tone	V _{OUT} = 2V _{PP} , f = 9.95MHz		-59		dBc
Crosstalk			65		dB
Group Delay Variation	1MHz < f < 10MHz, Full Gain Range		13		ns
ACCURACY					
Gain Slope	VCA _{CNTL} = 0.2V to 3.0V		16		dB/V
Gain Error ⁽¹⁾	VCA _{CNTL} = 0.2V to 3.0V		±2.0		dB
	VCA _{CNTL} = 0.4V to 2.9V		±1.3	±2	dB
Output Offset Voltage			±50		mV
GAIN CONTROL INTERFACE					
Input Voltage (VCA _{CNTL}) Range			0.2 to 3.0		V
Input Resistance			1		MΩ
Response Time	45dB Gain Change		0.2		μs
POWER SUPPLY					
Specified Operating Range		4.75	5.0	5.25	V
Power Dissipation	Operating, Each Channel		120	150	mW
Power-Down			9.2		mW

NOTE: (1) Referenced to best fit dB-linear curve.

PIN CONFIGURATION

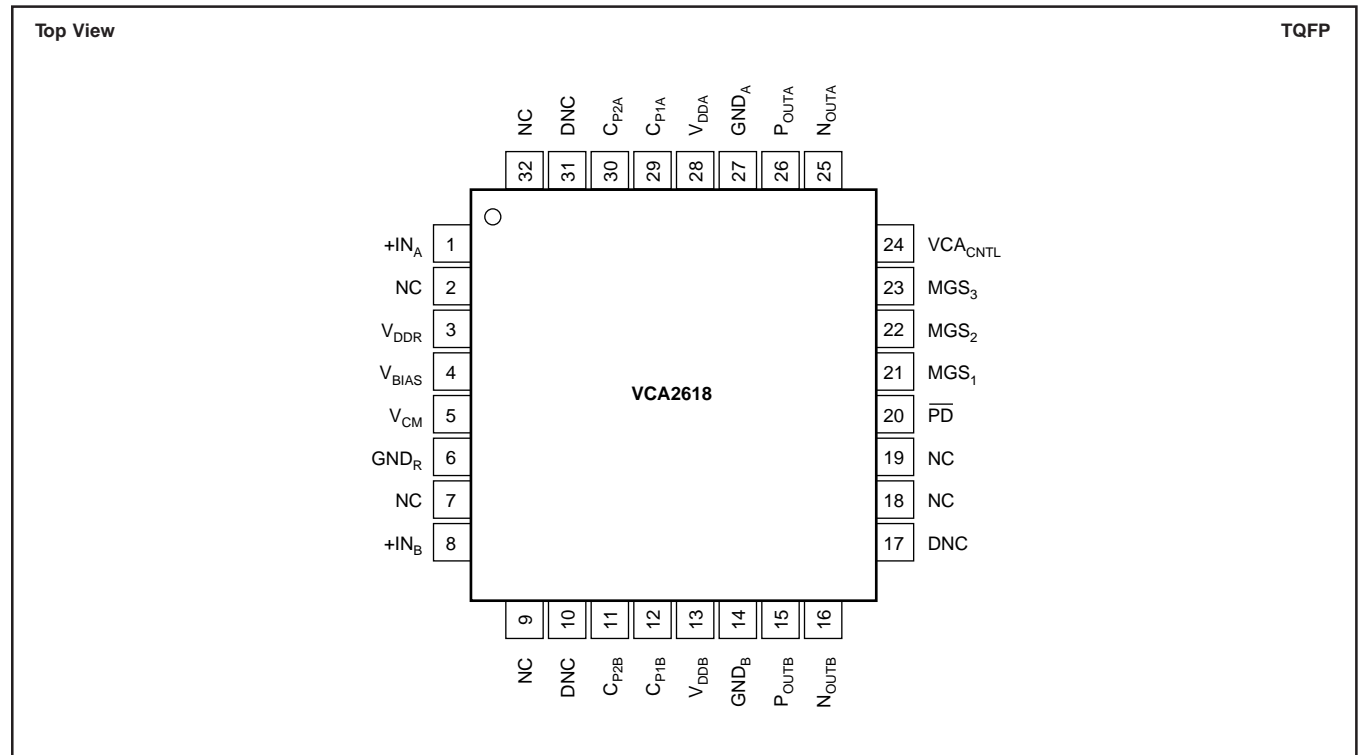

PIN DESCRIPTIONS

PIN	DESIGNATOR	DESCRIPTION	PIN	DESIGNATOR	DESCRIPTION
1	+IN _A	Noninverting Input Channel A	17	DNC	Do Not Connect
2	NC	No Internal Connection	18	NC	No Internal Connection
3	V _{DDR}	Internal Reference Supply	19	NC	No Internal Connection
4	V _{BIAS}	Bias Voltage	20	PD	Power-Down (Active LOW)
5	V _{CM}	Common-Mode Voltage	21	MGS ₁	Maximum Gain Select 1 (MSB)
6	GND _R	Internal Reference Ground	22	MGS ₂	Maximum Gain Select 2
7	NC	Not Connected	23	MGS ₃	Maximum Gain Select 3 (LSB)
8	+IN _B	Noninverting Input Channel B	24	VCA _{CNTL}	VCA Analog Control
9	NC	No Internal Connection	25	N _{OUTA}	Negative VCA Output Channel A
10	DNC	Do Not Connect	26	P _{OUTA}	Positive VCA Output Channel A
11	C _{P2B}	Coupling Capacitor Channel B	27	GND _A	Ground Channel A
12	C _{P1B}	Coupling Capacitor Channel B	28	V _{DDA}	+5V Supply Channel A
13	V _{DDB}	+5V Supply Channel B	29	C _{P1A}	Coupling Capacitor Channel A
14	GND _B	Ground Channel B	30	C _{P2A}	Coupling Capacitor Channel A
15	P _{OUTB}	Positive Output Channel B	31	DNC	Do Not Connect
16	N _{OUTB}	Negative Output Channel B	32	NC	No Internal Connection

TYPICAL CHARACTERISTICS

At $T_A = +25^\circ\text{C}$, $V_{DD} = 5\text{V}$, load resistance = 500Ω on each output to ground, differential output ($2V_{PP}$) MGS = 111, and $f_{IN} = 5\text{MHz}$, unless otherwise noted.

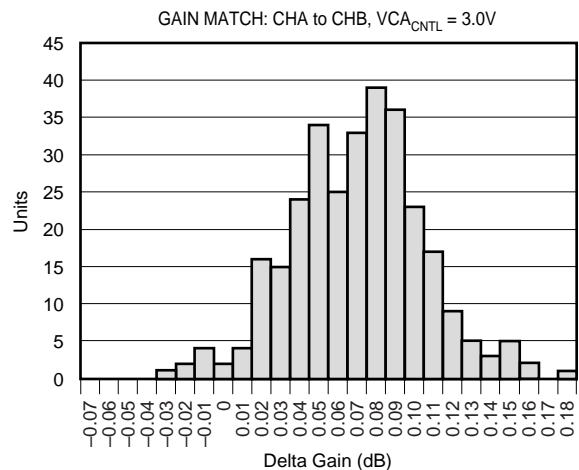
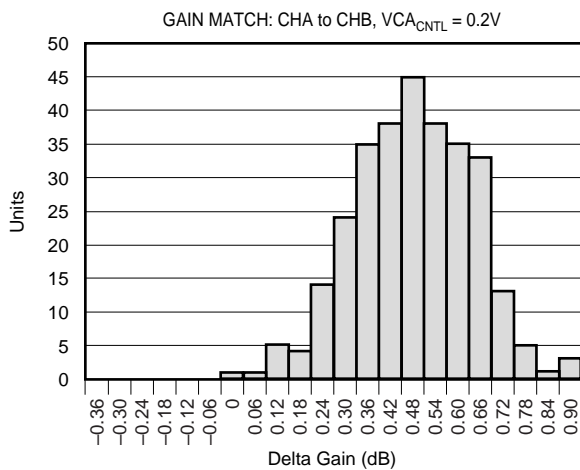
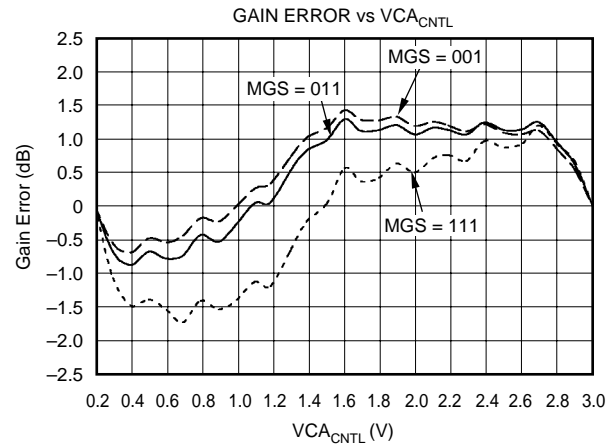
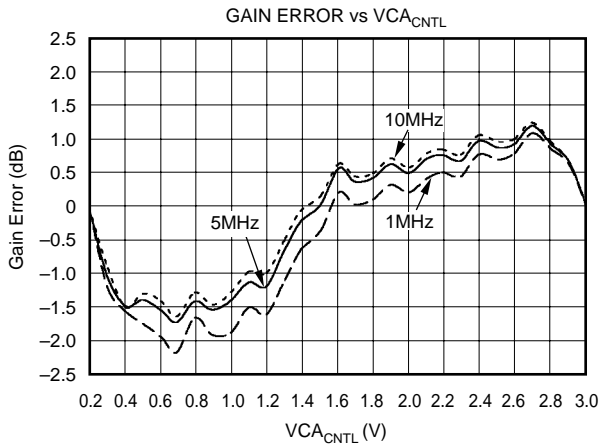
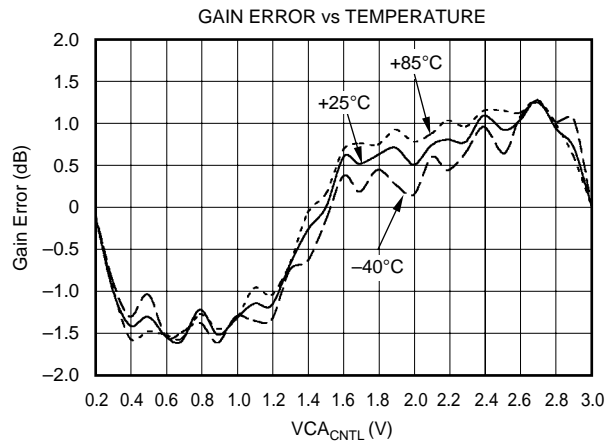
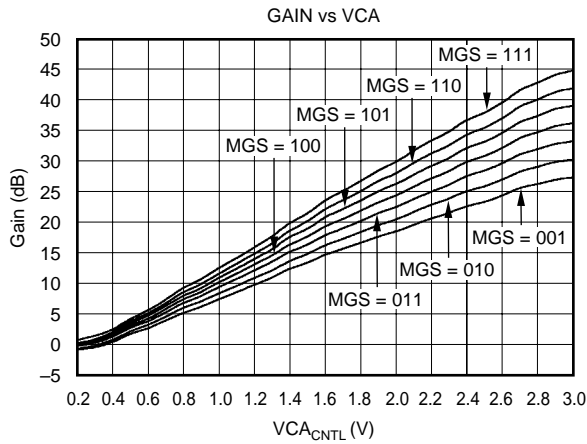

TYPICAL CHARACTERISTICS (Cont.)

At $T_A = +25^\circ\text{C}$, $V_{DD} = 5\text{V}$, load resistance = 500Ω on each output to ground, differential output ($2V_{pp}$) MGS = 111, and $f_{IN} = 5\text{MHz}$, unless otherwise noted.

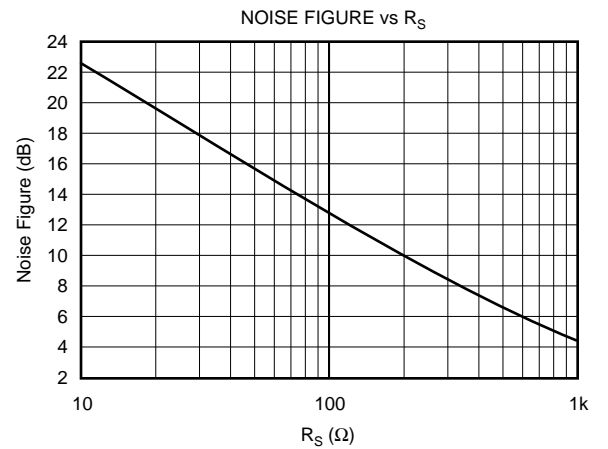
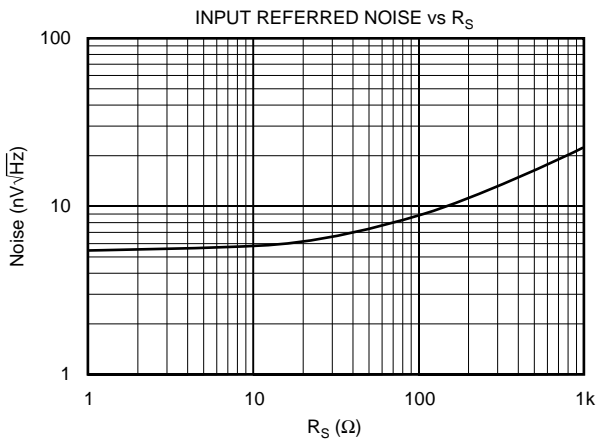
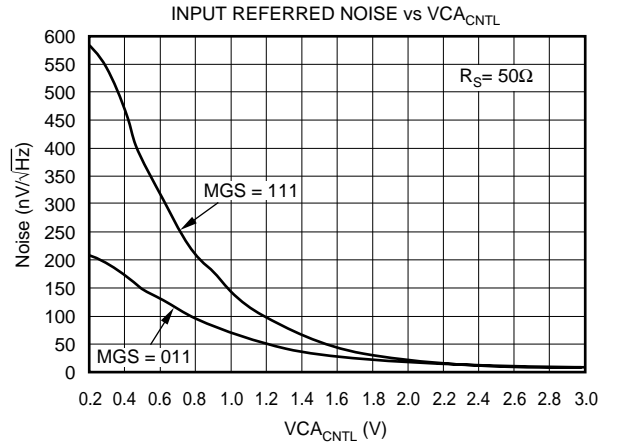
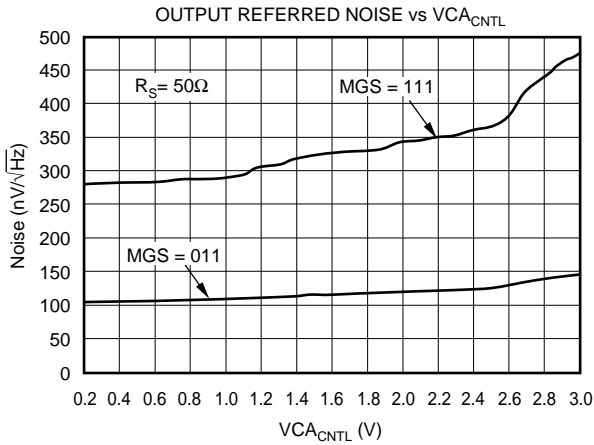
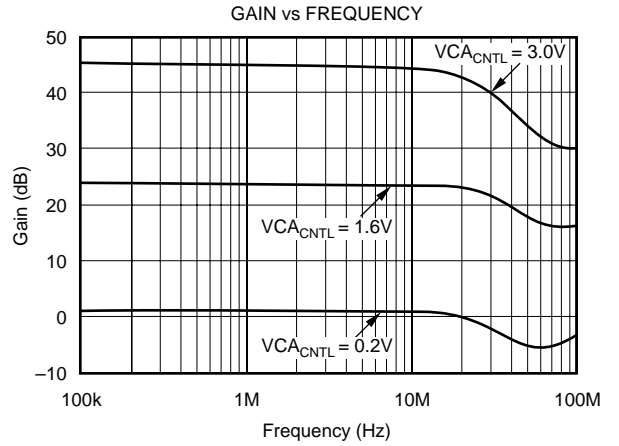
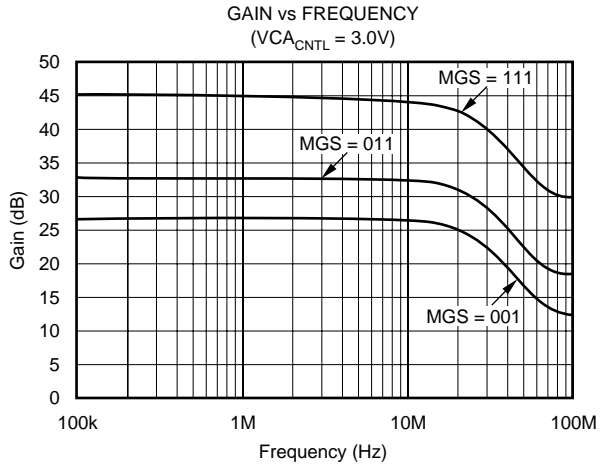

TYPICAL CHARACTERISTICS (Cont.)

At $T_A = +25^\circ\text{C}$, $V_{DD} = 5\text{V}$, load resistance = 500Ω on each output to ground, differential output ($2V_{pp}$) MGS = 111, and $f_{IN} = 5\text{MHz}$, unless otherwise noted.

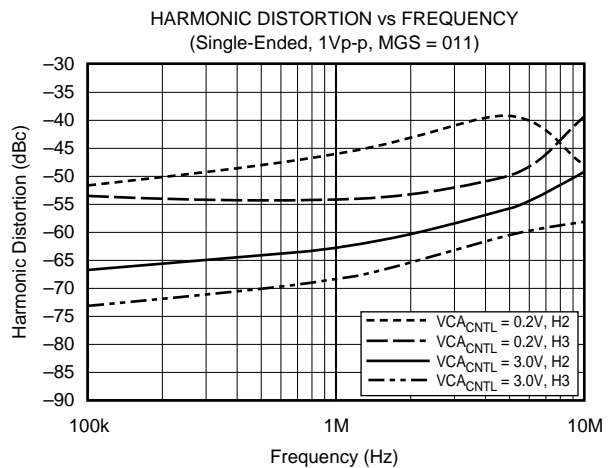
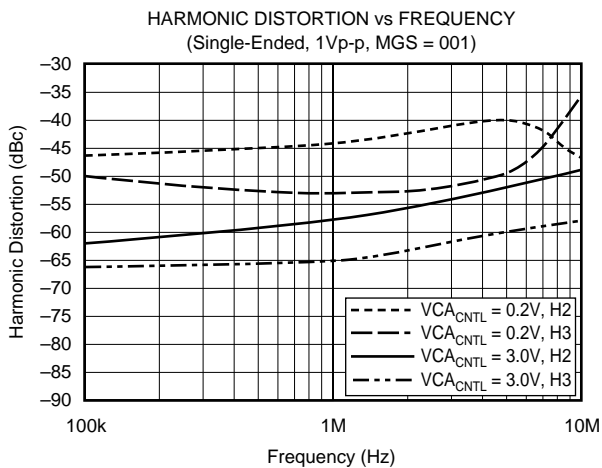
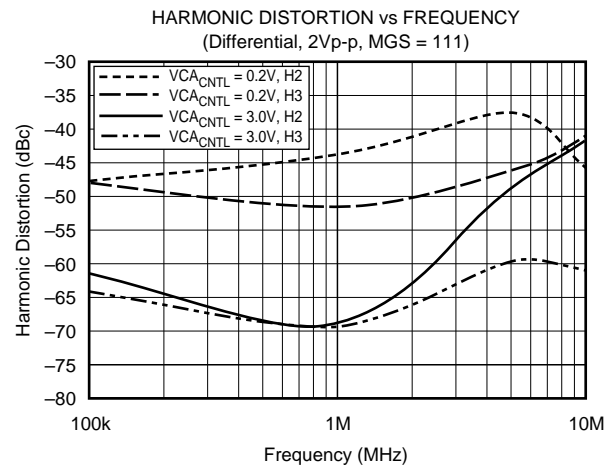
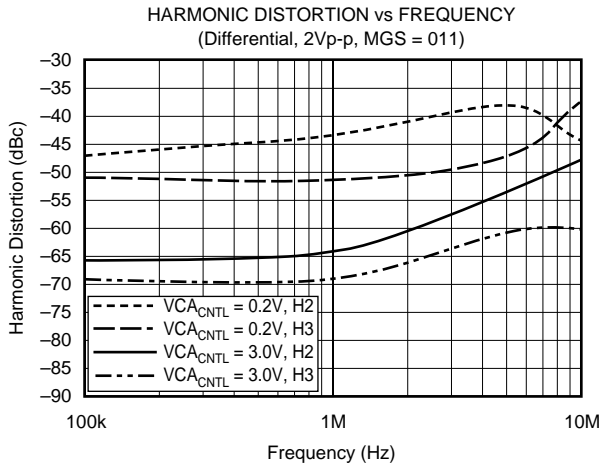
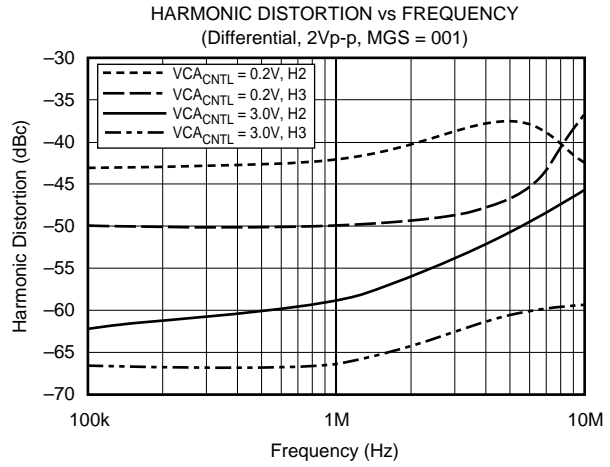
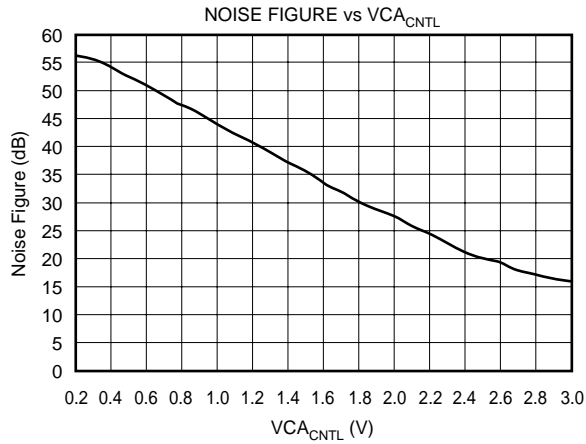

TYPICAL CHARACTERISTICS (Cont.)

At $T_A = +25^\circ\text{C}$, $V_{DD} = 5\text{V}$, load resistance = 500Ω on each output to ground, differential output ($2V_{pp}$) MGS = 111, and $f_{IN} = 5\text{MHz}$, unless otherwise noted.

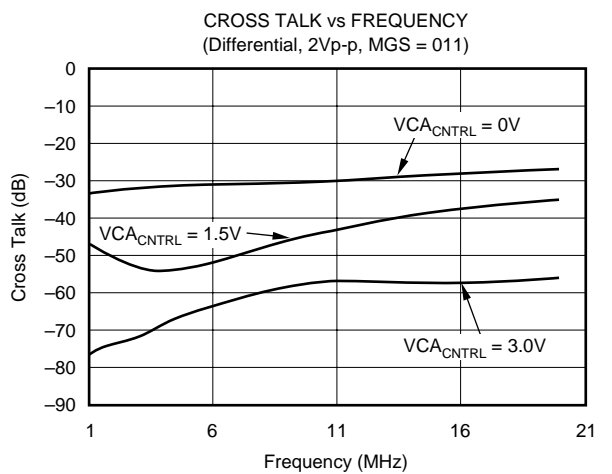
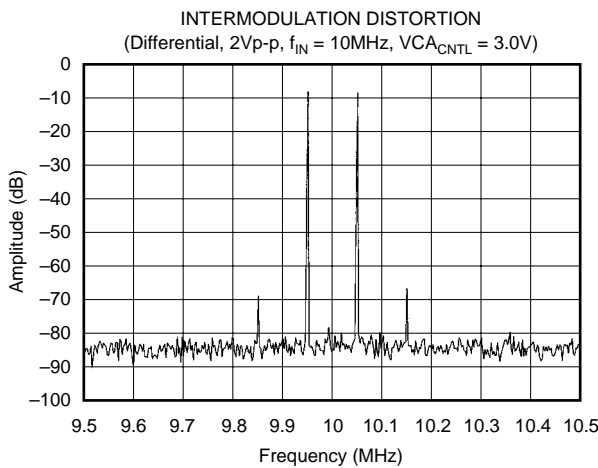
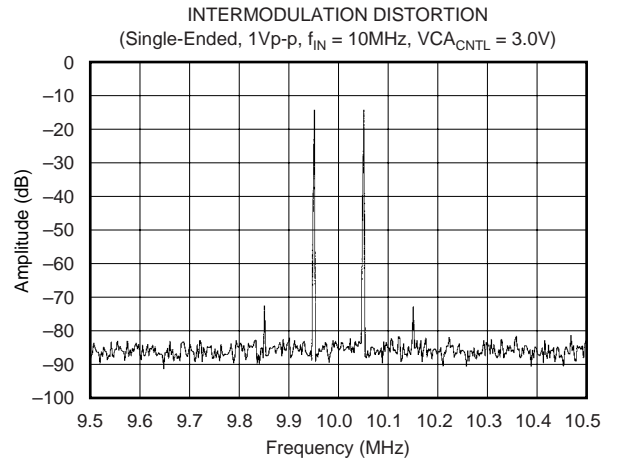
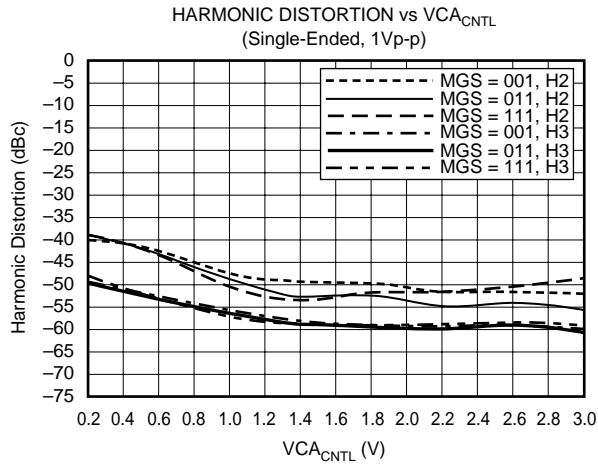
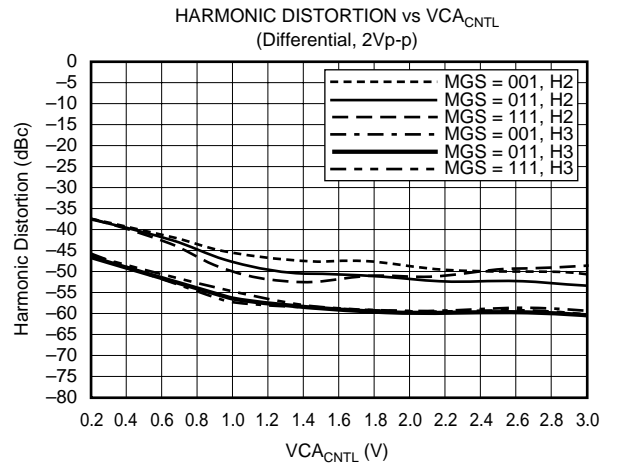
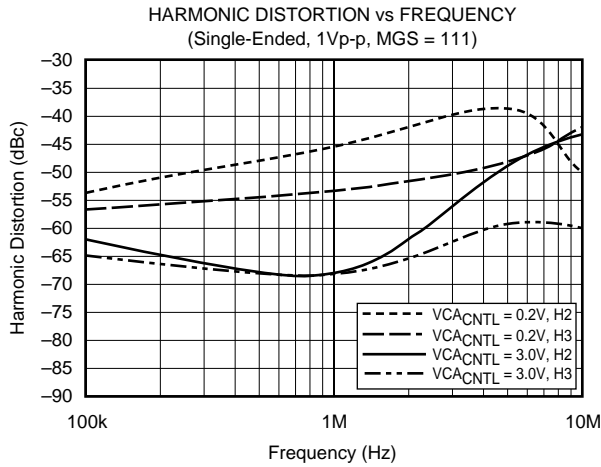

TYPICAL CHARACTERISTICS (Cont.)

At $T_A = +25^\circ\text{C}$, $V_{DD} = 5\text{V}$, load resistance = 500Ω on each output to ground, differential output (2Vp-p) MGS = 111, and $f_{IN} = 5\text{MHz}$, unless otherwise noted.

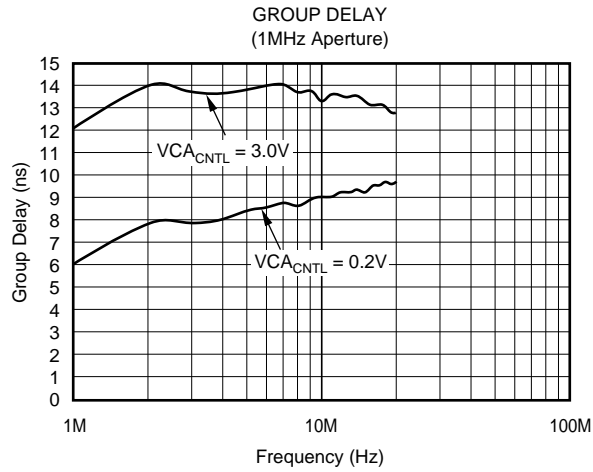
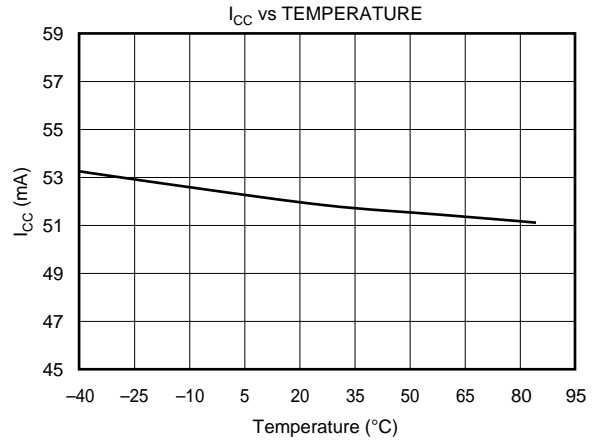
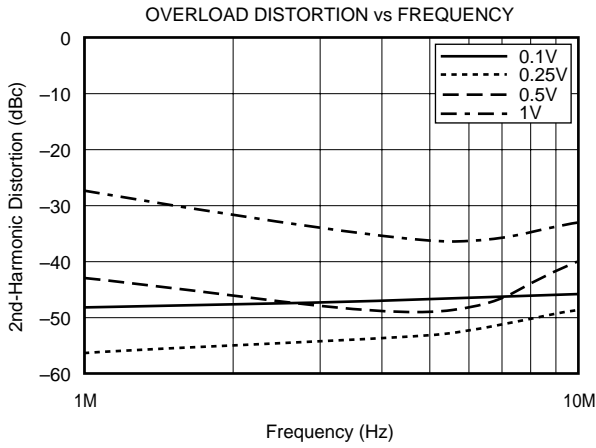

OVERVIEW

The VCA2618 is a dual-channel, VGA consisting of three primary blocks, an Input Buffer, a VCA, and a PGA. All stages are AC coupled, with the coupling into the PGA stage being made variable by placing an external capacitor between the C_{P1} and C_{P2} pins. This will be discussed further in the PGA section. By using the internal coupling into the PGA, the result is a high-pass filter characteristic with cutoff at approximately 75kHz. The output PGA naturally rolls off at around 30MHz, making the usable bandwidth of the VCA2618 between 75kHz and 30MHz.

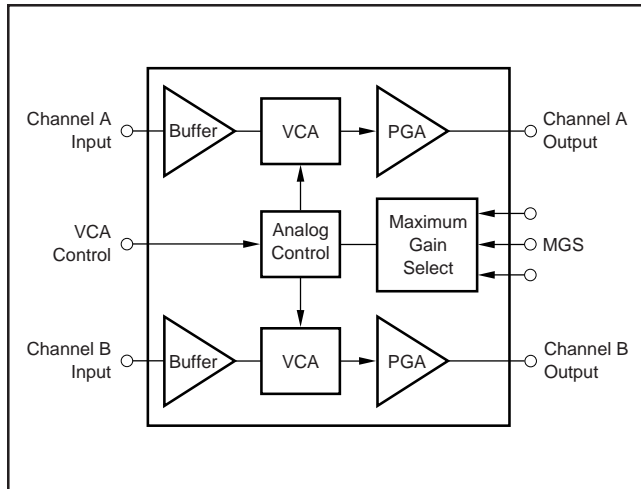

FIGURE 1. Simplified Block Diagram of the VCA2618.

INPUT BUFFER

The input buffer is a unity gain amplifier (gain of +1) with a bandwidth of 100MHz with an input resistance of approximately 600k Ω . The input buffer isolates the circuit driving the VCA2618 inputs from the internal VCA block, which would present a varying impedance to the input circuitry. To allow symmetrical operation of the input buffer, the input to the buffer must be AC coupled through an external capacitor. The recommended value of the capacitor is 0.01 μ F. It should be noted that if the capacitor value were increased, the

power-on time of the VCA2618 would be increased. If a decrease in the power-on time is needed, the value can be decreased to no less than 100pF.

VOLTAGE-CONTROLLED ATTENUATOR

The magnitude of the VCA input signal from the input buffer is reduced by a programmable attenuation factor, set by the analog VCA Control Voltage ($V_{CA_{CNTL}}$) at pin 24. The maximum attenuation is programmable by using the three MGS bits (pins 21, 22, and 23). Figure 2 illustrates this dual-adjust characteristic.

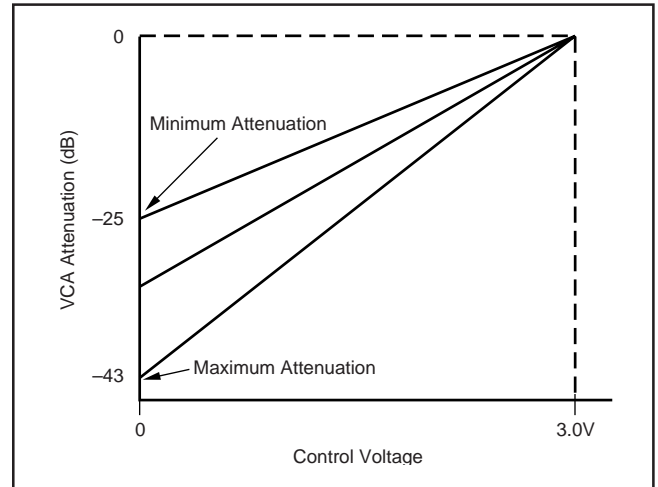

FIGURE 2. Swept Attenuator Characteristic.

The MGS bits adjust the overall range of attenuation and maximum gain while the $V_{CA_{CNTL}}$ voltage adjusts the actual attenuation factor. At any given maximum gain setting, the analog variable gain characteristic is linear in dB as a function of the control voltage, and is created as a piecewise approximation of an ideal dB-linear transfer function. The VCA control circuitry is common to both channels of the VCA2618. The range for the $V_{CA_{CNTL}}$ input spans from 0V to 3V. Although overdriving the $V_{CA_{CNTL}}$ input above the recommended 3V maximum will not damage the part, this condition should be avoided.

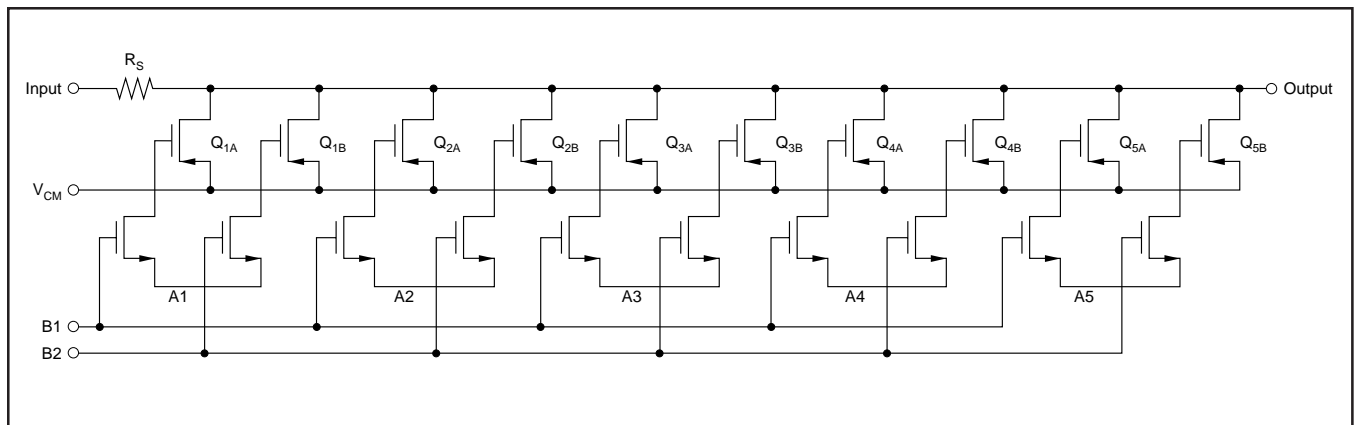

FIGURE 3. Programmable Attenuator Section.

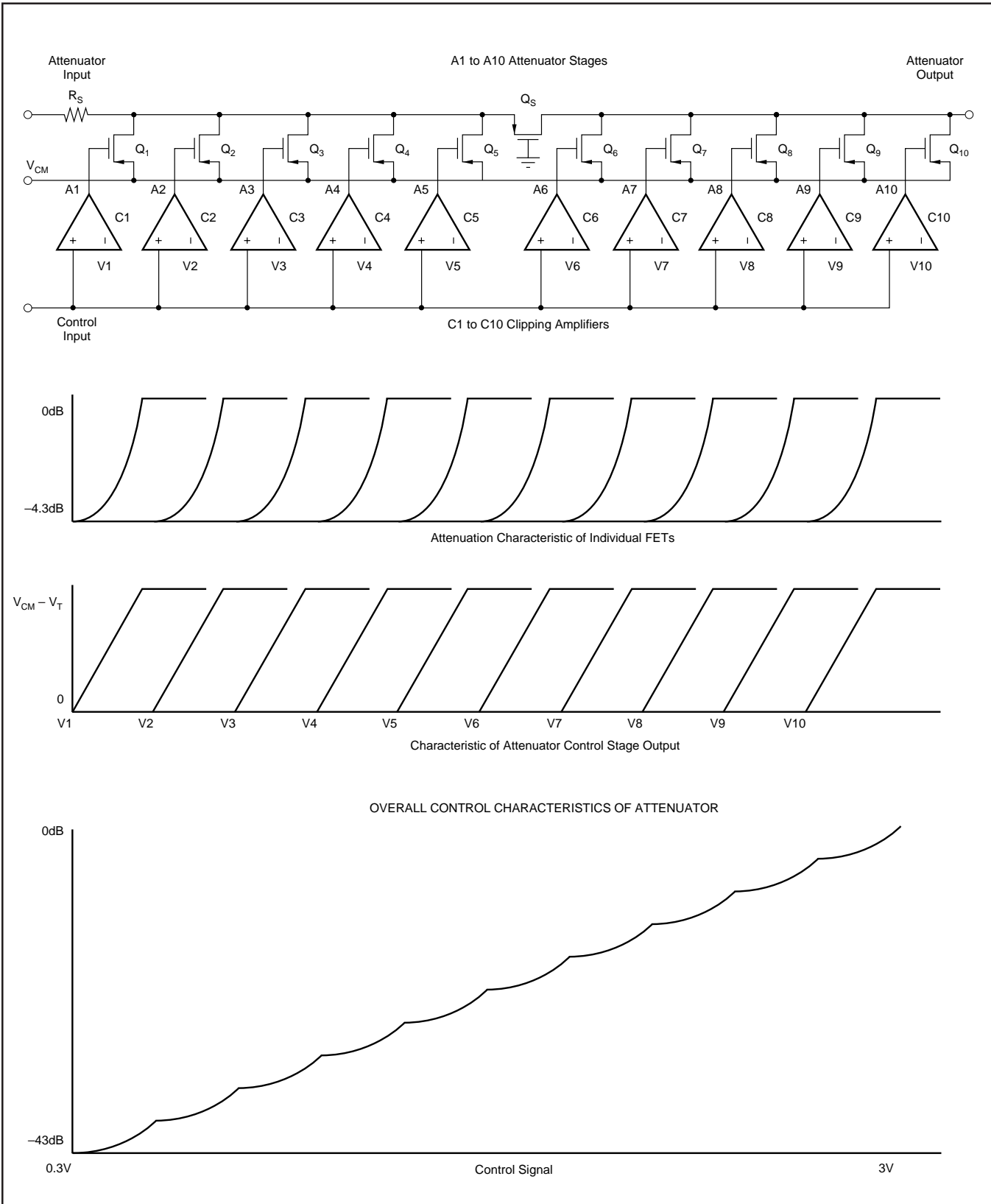

FIGURE 4. Piecewise Approximation to Logarithmic Control Characteristics.

PGA POST-AMPLIFIER

Figure 5 shows a simplified circuit diagram of the PGA block. As stated before, the input to the PGA is AC coupled by an internal capacitor. Provisions are made so that an external capacitor can be placed in parallel with the internal capacitor, thus lowering the usable low-frequency bandwidth. The low-frequency bandwidth is set by the following equation:

$$\frac{1}{(2 \cdot \pi \cdot 500\text{k}\Omega \cdot (220\text{pF} + C_{\text{EXTERNAL}}))}$$

where C_{EXTERNAL} is the external capacitor value in farads.

Care should be taken to avoid using too large a value of capacitor, as this can increase the power-on delay time.

As described previously, the PGA gain is programmed with the same MGS bits that control the VCA maximum attenuation factor. Specifically, the maximum PGA gain at each MGS setting is the inverse (reciprocal) of the maximum VCA attenuation at that setting. Therefore, the VCA + PGA overall gain will always be 0dB (unity) when the analog VCA_{CNTL} input is set to 0V (the maximum attenuation for VCA). For $VCA_{\text{CNTL}} = 3\text{V}$ (no attenuation), the VCA + PGA gain will be controlled by the programmed PGA gain (25dB to 43dB in 3dB steps). For clarity, the gain and attenuation factors are detailed in Table I.

The PGA architecture converts the single-ended signal from the VCA into a differential signal. Low input noise was also a requirement of the PGA design due to the large amount of signal attenuation that can be asserted before the PGA. At minimum VCA attenuation (used for small input signals), the

MGS SETTING	ATTENUATOR GAIN $VCA_{\text{CNTL}} = 0\text{V to }3\text{V}$	ATTENUATOR + DIFFERENTIAL PGA GAIN
000	Not Valid	Not Valid
001	-25dB to 0dB	0dB to 25dB
010	-28dB to 0dB	0dB to 28dB
011	-31dB to 0dB	0dB to 31dB
100	-34dB to 0dB	0dB to 34dB
101	-37dB to 0dB	0dB to 37dB
110	-40dB to 0dB	0dB to 40dB
111	-43dB to 0dB	0dB to 43dB

TABLE I. MGS Settings.

input buffer noise dominates; at maximum VCA attenuation (large input signals), the PGA noise dominates. Note that if the PGA output is used single-ended, the apparent gain will be 6dB lower.

LAYOUT CONSIDERATIONS

The VCA2618 is an analog amplifier capable of high gain. When working on a PCB layout for the VCA2618, it is recommended to utilize a solid ground plane that is connected to analog ground. This helps to maximize the noise performance of the VCA2618.

Adequate power-supply decoupling must be used in order to achieve the best possible performance. Decoupling capacitors on the VCA_{CNTL} voltage should also be used to help minimize noise. Recommended values can be obtained from the layout diagram of Figure 6.

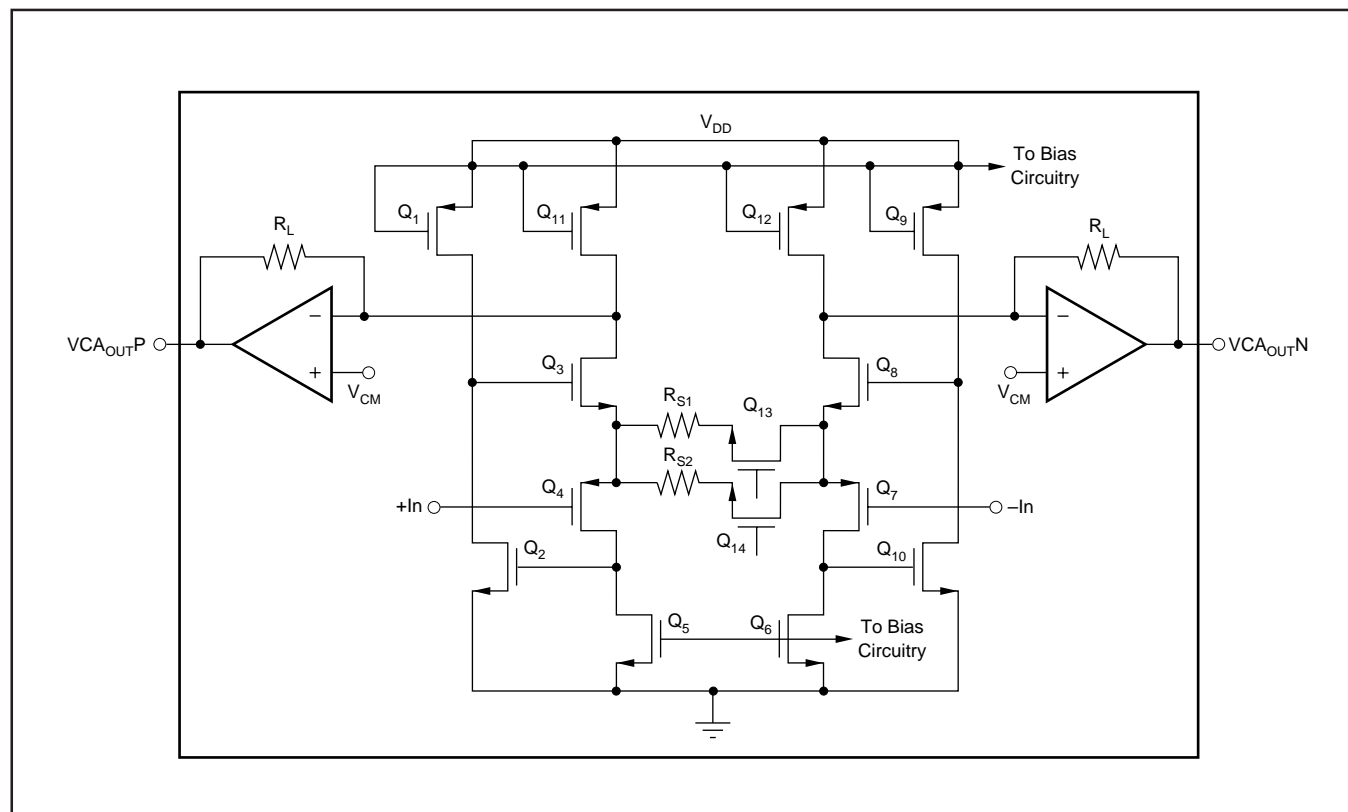

FIGURE 5. Simplified Block Diagram of the PGA Section with the VCA2618.

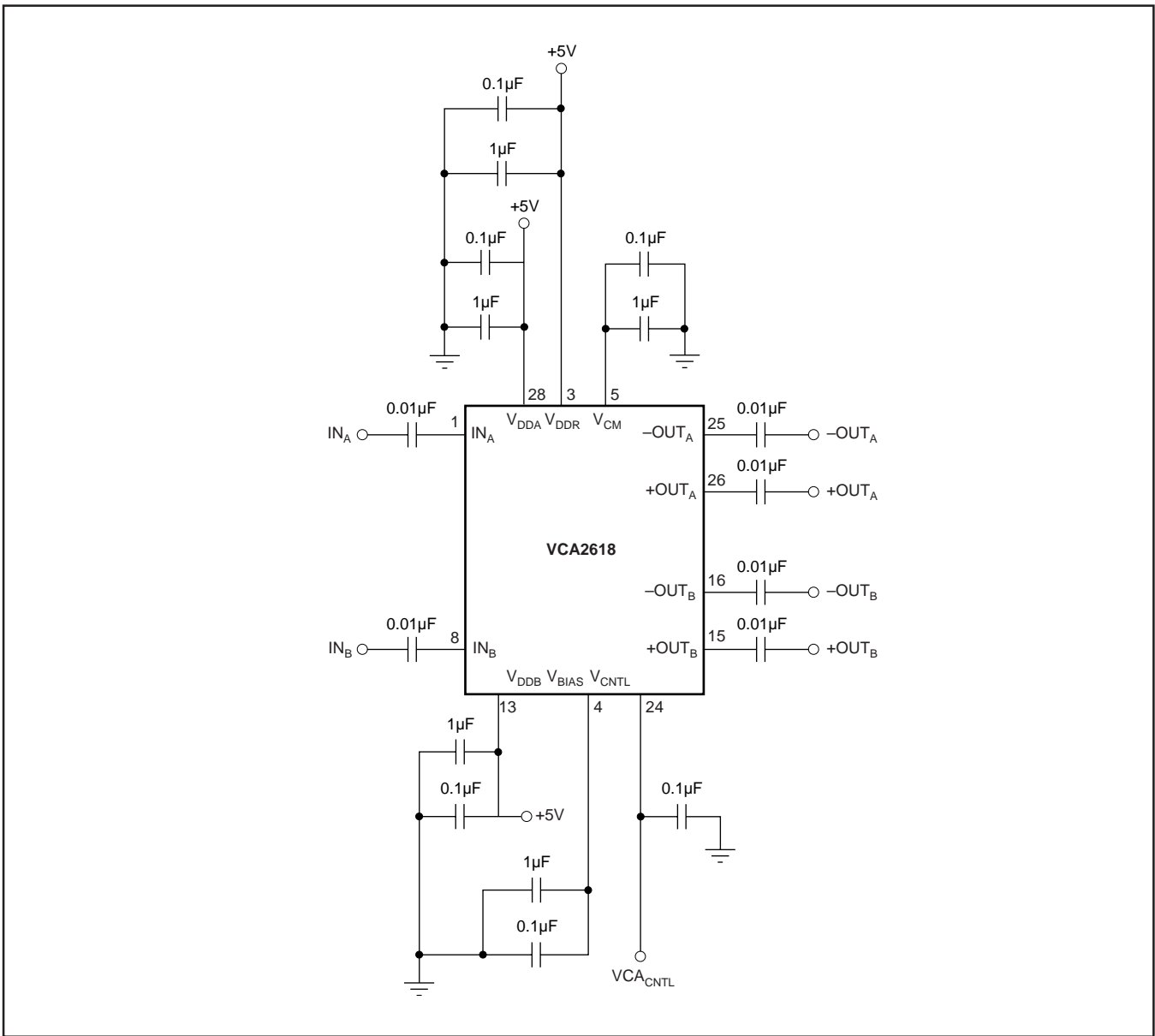

FIGURE 6. VCA2618 Layout.

IMPORTANT NOTICE

Texas Instruments Incorporated and its subsidiaries (TI) reserve the right to make corrections, modifications, enhancements, improvements, and other changes to its products and services at any time and to discontinue any product or service without notice. Customers should obtain the latest relevant information before placing orders and should verify that such information is current and complete. All products are sold subject to TI's terms and conditions of sale supplied at the time of order acknowledgment.

TI warrants performance of its hardware products to the specifications applicable at the time of sale in accordance with TI's standard warranty. Testing and other quality control techniques are used to the extent TI deems necessary to support this warranty. Except where mandated by government requirements, testing of all parameters of each product is not necessarily performed.

TI assumes no liability for applications assistance or customer product design. Customers are responsible for their products and applications using TI components. To minimize the risks associated with customer products and applications, customers should provide adequate design and operating safeguards.

TI does not warrant or represent that any license, either express or implied, is granted under any TI patent right, copyright, mask work right, or other TI intellectual property right relating to any combination, machine, or process in which TI products or services are used. Information published by TI regarding third-party products or services does not constitute a license from TI to use such products or services or a warranty or endorsement thereof. Use of such information may require a license from a third party under the patents or other intellectual property of the third party, or a license from TI under the patents or other intellectual property of TI.

Reproduction of information in TI data books or data sheets is permissible only if reproduction is without alteration and is accompanied by all associated warranties, conditions, limitations, and notices. Reproduction of this information with alteration is an unfair and deceptive business practice. TI is not responsible or liable for such altered documentation.

Resale of TI products or services with statements different from or beyond the parameters stated by TI for that product or service voids all express and any implied warranties for the associated TI product or service and is an unfair and deceptive business practice. TI is not responsible or liable for any such statements.

Following are URLs where you can obtain information on other Texas Instruments products and application solutions:

Products		Applications	
Amplifiers	amplifier.ti.com	Audio	www.ti.com/audio
Data Converters	dataconverter.ti.com	Automotive	www.ti.com/automotive
DSP	dsp.ti.com	Broadband	www.ti.com/broadband
Interface	interface.ti.com	Digital Control	www.ti.com/digitalcontrol
Logic	logic.ti.com	Military	www.ti.com/military
Power Mgmt	power.ti.com	Optical Networking	www.ti.com/opticalnetwork
Microcontrollers	microcontroller.ti.com	Security	www.ti.com/security
		Telephony	www.ti.com/telephony
		Video & Imaging	www.ti.com/video
		Wireless	www.ti.com/wireless

Mailing Address: Texas Instruments
Post Office Box 655303 Dallas, Texas 75265

Copyright © 2003, Texas Instruments Incorporated

Copyright © Each Manufacturing Company.

All Datasheets cannot be modified without permission.

This datasheet has been download from :

www.AllDataSheet.com

100% Free DataSheet Search Site.

Free Download.

No Register.

Fast Search System.

www.AllDataSheet.com