



8-Channel VARIABLE GAIN AMPLIFIER

FEATURES

- 3V OPERATION
- LOW INPUT NOISE: $1.0\text{nV}/\sqrt{\text{Hz}}$ at $f_{\text{IN}} = 5\text{MHz}$
- EXTREMELY LOW POWER OPERATION: 100mW/CHANNEL
- INTEGRATED LOW-PASS, 2-POLE FILTER 15MHz BANDWIDTH

- INTEGRATED INPUT CLAMP DIODES
- DIFFERENTIAL OUTPUT
- INTEGRATED INPUT LNA
- READABLE CONTROL REGISTERS
- INTEGRATED CONTINUOUS WAVE (CW) PROCESSOR

DESCRIPTION

The VCA8617 is an 8-channel variable gain amplifier ideally suited to portable ultrasound applications. Excellent dynamic performance enables use in low-power, high-performance portable applications. Each channel consists of a 20dB gain Low-Noise pre-Amplifier (LNA) and a Variable Gain Amplifier (VGA). The differential outputs of the LNA can be switched through the 8x10 cross-point switch, which is programmable through the serial interface input port.

The output of the LNA is fed directly into the VGA stage. The VGA consists of two parts, a Voltage-Controlled Attenuator (VCA) and a Programmable Gain Amplifier

(PGA). The gain and gain range of the PGA can be digitally configured separately. The gain of the PGA can vary between four discrete settings of 25dB, 30dB, 35dB, and 40dB. The VCA has four programmable maximum attenuation settings: 29dB, 33dB, 36.5dB, and 40dB. Also, the VCA can be continuously varied by a control voltage from 0dB to a maximum of 29dB, 33dB, 36.5dB, and 40dB.

The output of the PGA feeds directly into an integrated two-pole, low-pass filter.

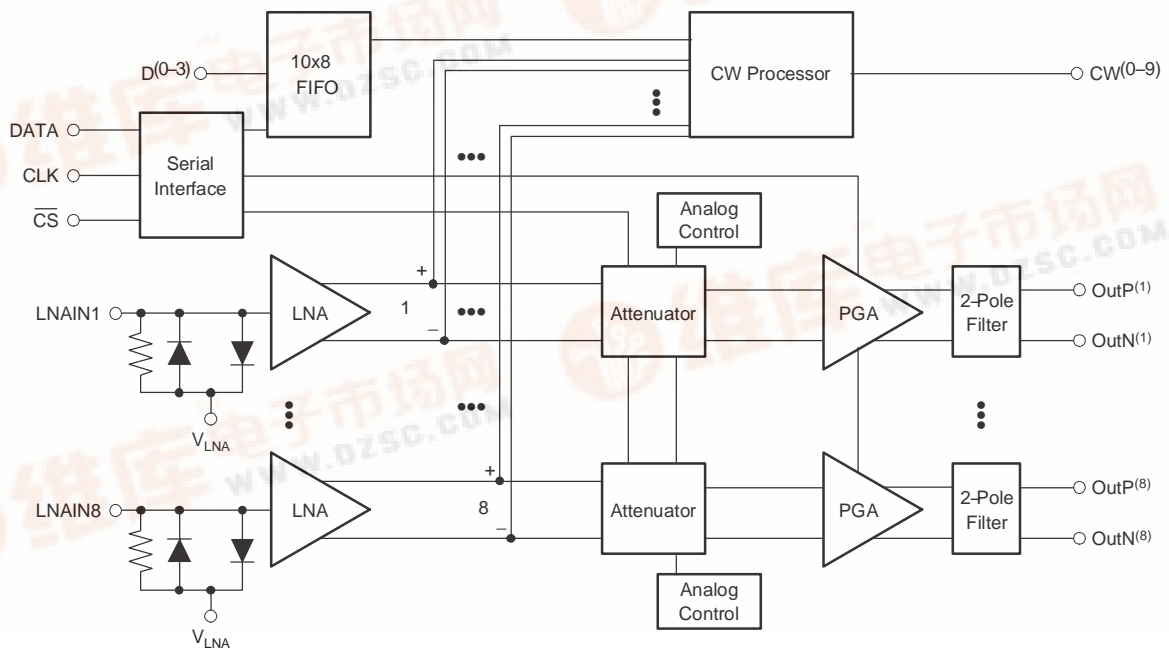

ABSOLUTE MAXIMUM RATINGS⁽¹⁾

+AV _{DD}	+3.6V
Analog Input	–0.3V to +AV _{DD} + 0.3V
Logic Input	–0.3V to +AV _{DD} + 0.3V
Case Temperature	+100°C
Junction Temperature	+150°C
Storage Temperature	+150°C
Thermal Resistance, Junction-to-Ambient (θ_{JA})	66.6°C/W
Thermal Resistance, Junction-to-Case(θ_{JC})	4.3°C/W

(1) Stresses above these ratings may cause permanent damage. Exposure to absolute maximum conditions for extended periods may degrade device reliability. These are stress ratings only, and functional operation of the device at these or any other conditions beyond those specified is not implied.

PACKAGE/ORDERING INFORMATION⁽¹⁾

PRODUCT	PACKAGE-LEAD	PACKAGE DESIGNATOR	SPECIFIED TEMPERATURE RANGE	PACKAGE MARKING	ORDERING NUMBER	TRANSPORT MEDIA, QUANTITY
VCA8617	TQFP-64	PAG	–40°C to +85°C	VCA8617PAG	VCA8617PAGT	Tape and Reel, 250
					VCA8617PAGR	Tape and Reel, 1500

(1) For the most current package and ordering information, see the Package Option Addendum located at the end of this data sheet.

ELECTROSTATIC DISCHARGE SENSITIVITY



This integrated circuit can be damaged by ESD. Texas Instruments recommends that all integrated circuits be handled with appropriate precautions. Failure to observe proper handling and installation procedures can cause damage.

ESD damage can range from subtle performance degradation to complete device failure. Precision integrated circuits may be more susceptible to damage because very small parametric changes could cause the device not to meet its published specifications.

ELECTRICAL CHARACTERISTICS: $AV_{DD} = 3V$

At $T_A = +25^\circ\text{C}$, load resistance = $1\text{k}\Omega$ on each output to ground, unless otherwise noted. The input to the preamp (LNA) is single-ended; pre-amp gain is fixed at +20dB, $f_{IN} = 2\text{MHz}$, PG = 01, ATN = 00, and the output from the VCA is differential, unless otherwise noted.

PARAMETER	CONDITIONS	VCA8617			UNITS
		MIN	TYP	MAX	
PREAMPLIFIER					
Input Resistance			4.5		$\text{k}\Omega$
Input Capacitance			52		pF
Input Bias Current			1		nA
Maximum Input Voltage ⁽¹⁾			200		mV _{pp}
Input Voltage Noise (TGC)	$f_{IN} = 5\text{MHz}$		1.05		$\text{nV}/\sqrt{\text{Hz}}$
Input Voltage Noise (CW)	$f_{IN} = 5\text{MHz}$		1.15		$\text{nV}/\sqrt{\text{Hz}}$
Output Swing (Differential)			2		V
Bandwidth			100		MHz
Gain			20		dB
ACCURACY					
Gain Slope	0.2V – 1.7V, VCA _{CNTRL}		18		dB/V
Gain Error	0.2V – 1.7V, VCA _{CNTRL}			1.7	dB
Output Offset Voltage	Differential		0.65		mV
GAIN CONTROL INTERFACE					
Input Voltage (VCA _{CNTRL}) Range			0 to 20		V
Input Resistance			1		$\text{M}\Omega$
Response Time	40dB Gain Change, PG = 11		0.2		μs
POWER SUPPLY					
Specified Operating Range		2.85	3.0	3.15	V
Power-Down Delay			5		μs
Power-Up Delay			100		μs
Power Dissipation (TGC Mode)	Operating All Channels		825	950	mW
PROGRAMMABLE VGA AND LOW-PASS FILTER					
–3dB Cutoff (low-pass)			14.5		MHz
–3dB Cutoff (high-pass)			400		kHz
Slew Rate			300		V/ μs
Output Impedance			10		Ω
Crosstalk			49		dB
Output Common-Mode			1.5		V
Output Swing (Differential) ⁽²⁾				2	V _{pp}
3rd-Harmonic Distortion			–65	–50	dB
2nd-Harmonic Distortion			–60	–50	dB
Group Delay Variation			± 3		ns
CONTINUOUS WAVE PROCESSOR					
V/I Converter Transconductance		17	20	23	mA/V
Common-Mode			1.4		V
Max Output Swing			3.4		mApp
LOGIC INPUTS					
V_{IN} LOW (input low voltage)		0		0.6	V
V_{IN} HIGH (input high voltage)		2.1		V_{DD}	V
Input Current				± 1	μA
Input Pin Capacitance			5		pF
Clock Input Frequency		10k		25M	Hz

(1) Under conditions when input signal is within linear range of LNA.

(2) Under conditions when signal is within linear range of output amplifier.

VCA8617

SBOS308B – AUGUST 2004 – REVISED NOVEMBER 2004

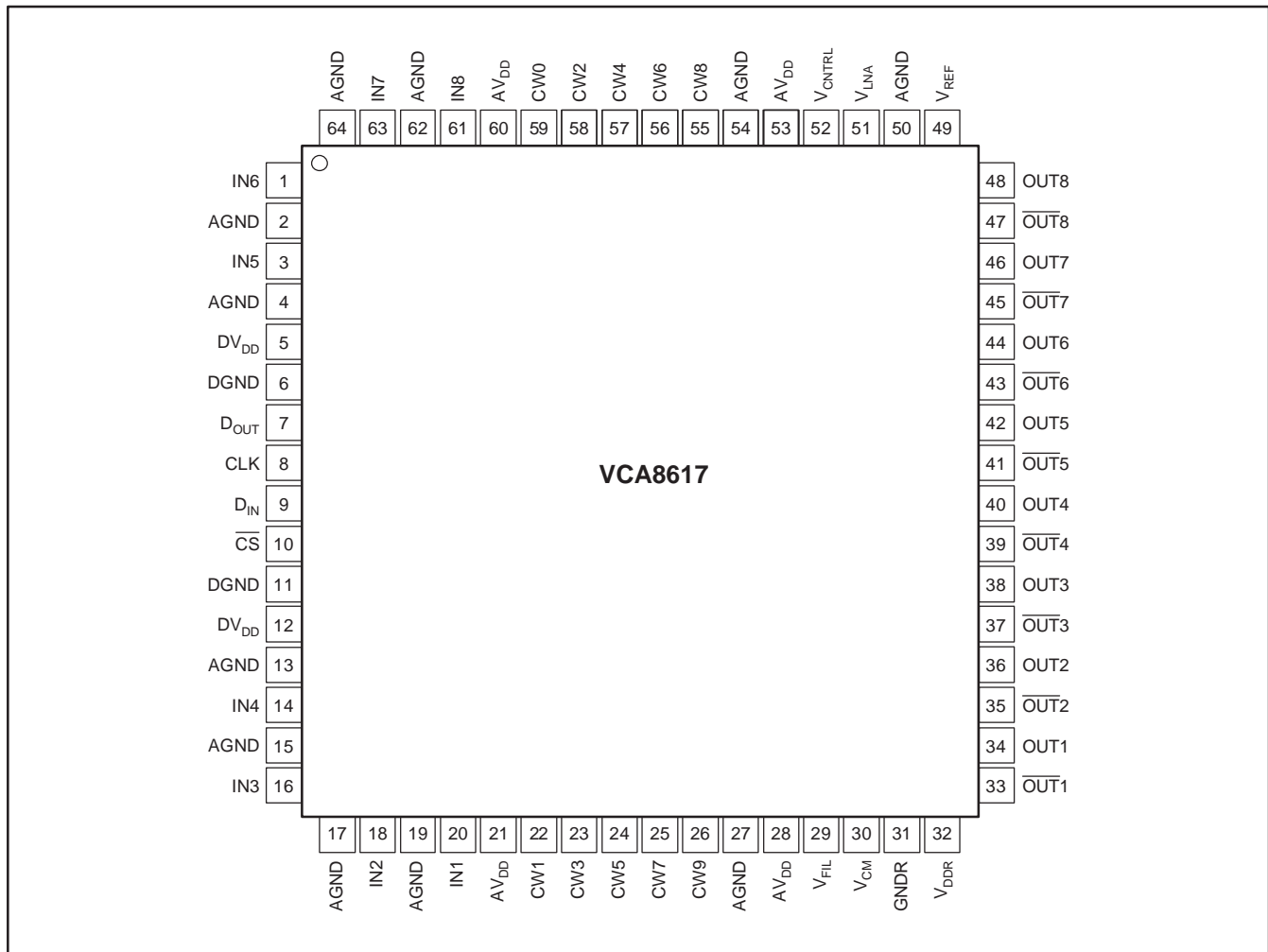

PIN DESCRIPTIONS

PIN	DESIGNATOR	DESCRIPTION
5, 12	DVDD	Digital supplies
2, 4, 13, 15, 17, 19, 27, 50, 54, 62, 64	AGND	Analog ground
1, 3, 14, 16, 18, 20, 61, 63	IN(1–8)	Single-ended LNA inputs
22–26, 55–59	CW(0–9)	Continuous wave outputs
51	VLNA	Reference voltage for LNA—internally generated; requires external bypass cap
29	VFIL	Reference voltage for Output Filter—internally generated; requires external bypass cap
30	VCM	Common-mode voltage—internally generated; requires external bypass cap
24, 36, 38, 40, 42, 44, 46, 48	OUT(1–8)	Positive polarity PGA outputs
33, 35, 37, 39, 41, 43, 45, 47	$\overline{\text{OUT}}(1–8)$	Negative polarity PGA outputs
52	VCTRL	Attenuator control input
9	DIN	Serial data input pin
10	$\overline{\text{CS}}$	Serial data chip select
8	CLK	Serial data input clock
7	DOUT	Serial data output pin
21, 28, 53, 60	AVDD	Analog supplies
6, 11	DGND	Digital ground
49	VREF	Reference voltage for attenuator—internally generated; requires external bypass cap
32	VDDR	Reference power supply
31	GNDR	Reference ground

INPUT REGISTER BIT MAPS
Byte 1—Control Byte Register Map

BIT #	NAME	DESCRIPTION
LSB	1	Start bit; always a '1'—40-bit count down starts upon first '1' after chip select.
1	$\overline{W/R}$	1 = Write, 0 = Read—Read prevents latching of DATA only—Control register still latched.
2	PWR	Entire chip. Power Control—1 = Off. Otherwise, chip is on.
3	A0	Attenuator control bit.
4	A1	Attenuator control bit.
5	Mode	1 = TGC Control mode (CW powered down), 0 = Doppler mode (TGC powered down)
6	PG0	LSB of PGA Gain Control
MSB	PG1	MSB of PGA Gain Control

Byte 2—First Data Byte

BIT #	NAME	DESCRIPTION
LSB	Data 1:0	Channel 1, LSB of Matrix Control
1	Data 1:1	Channel 1, Matrix Control
2	Data 1:2	Channel 1, Matrix Control
3	Data 1:3	Channel 1, MSB of Matrix Control
4	Data 2:0	Channel 2, LSB of Matrix Control
5	Data 2:1	Channel 2, Matrix Control
6	Data 2:2	Channel 2, Matrix Control
MSB	Data 2:3	Channel 2, MSB of Matrix Control

Byte 3—Second Data Byte

BIT #	NAME	DESCRIPTION
LSB	Data 3:0	Channel 3, LSB of Matrix Control
1	Data 3:1	Channel 3, Matrix Control
2	Data 3:2	Channel 3, Matrix Control
3	Data 3:3	Channel 3, MSB of Matrix Control
4	Data 4:0	Channel 4, LSB of Matrix Control
5	Data 4:1	Channel 4, Matrix Control
6	Data 4:2	Channel 4, Matrix Control
MSB	Data 4:3	Channel 4, MSB of Matrix Control

Byte 4—Third Data Byte

BIT #	NAME	DESCRIPTION
LSB	Data 5:0	Channel 5, LSB of Matrix Control
1	Data 5:1	Channel 5, Matrix Control
2	Data 5:2	Channel 5, Matrix Control
3	Data 5:3	Channel 5, MSB of Matrix Control
4	Data 6:0	Channel 6, LSB of Matrix Control
5	Data 6:1	Channel 6, Matrix Control
6	Data 6:2	Channel 6, Matrix Control
MSB	Data 6:3	Channel 6, MSB of Matrix Control

Byte 5—Fourth Data Byte

BIT #	NAME	DESCRIPTION
LSB	Data 7:0	Channel 7, LSB of Matrix Control
1	Data 7:1	Channel 7, Matrix Control
2	Data 7:2	Channel 7, Matrix Control
3	Data 7:3	Channel 7, MSB of Matrix Control
4	Data 8:0	Channel 8, LSB of Matrix Control
5	Data 8:1	Channel 8, Matrix Control
6	Data 8:2	Channel 8, Matrix Control
MSB	Data 8:3	Channel 8, MSB of Matrix Control

WRITE/READ TIMING

Generally follows SP1 Timing Specification:

- All writes and reads will be 8 bytes at a time;
- Separate write and read data lines;
- Reads will follow the same bit stream pattern seen in the write cycle;
- Reads will extract data from the FIFO, not the latched register;
- D_{OUT} data is continuously available and need not be enabled with a read cycle. Selecting a read cycle in the control register *only* prevents latching of data. The control register is still latched.

WRITE CYCLE TIMING

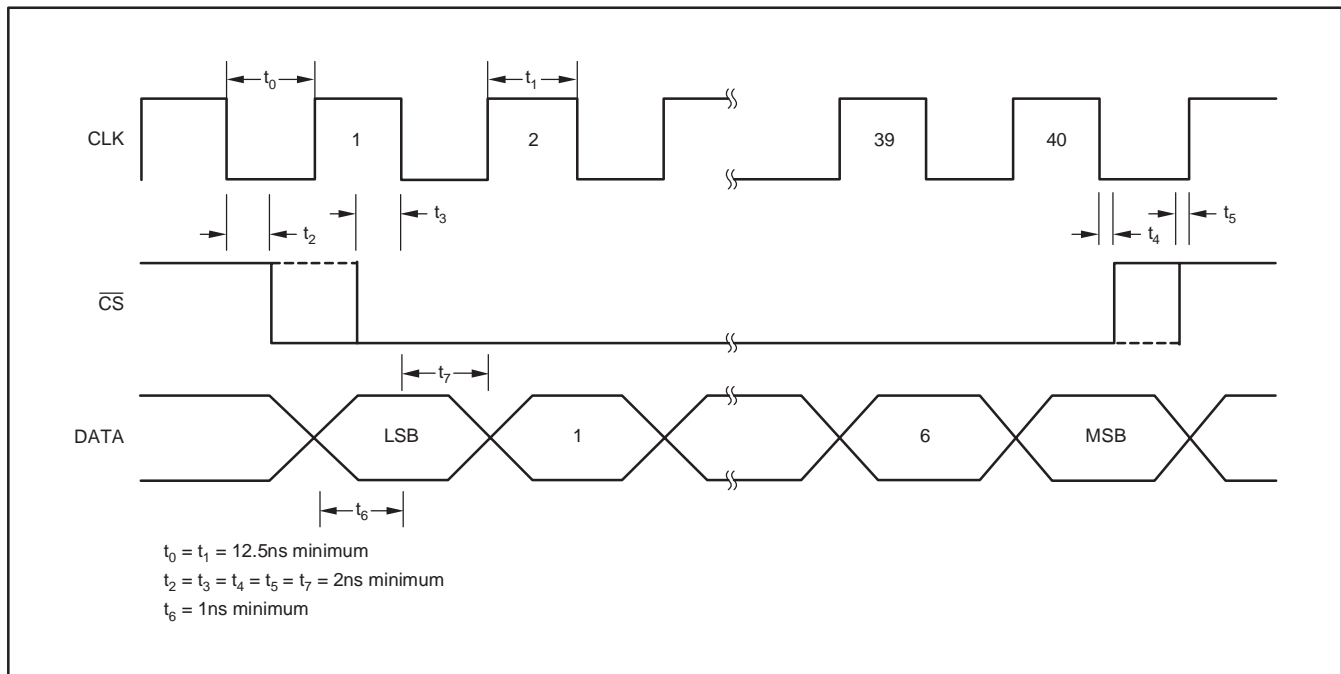

NOTE: It is highly recommended that the clock be turned off after the required data has been programmed into the VCA8617.

SERIAL PORT TIMING TABLE

Chip Select (\overline{CS}) must be held low (active LOW) during transfer. \overline{CS} can be held permanently low.

PARAMETER	DESCRIPTION	MIN	TYP	MAX	UNITS
t_1	Serial CLK Period	40			ns
t_2	Serial CLK HIGH Time	13			ns
t_3	Serial CLK LOW Time	13			ns
t_4	\overline{CS} Falling Edge to Serial CLK Falling Edge	10			ns
t_5	Data Setup Time	5			ns
t_6	Data Hold Time	5			ns
t_7	Serial CLK Falling Edge to \overline{CS} Rising Edge	10			ns

DATA SHIFT SEQUENCE

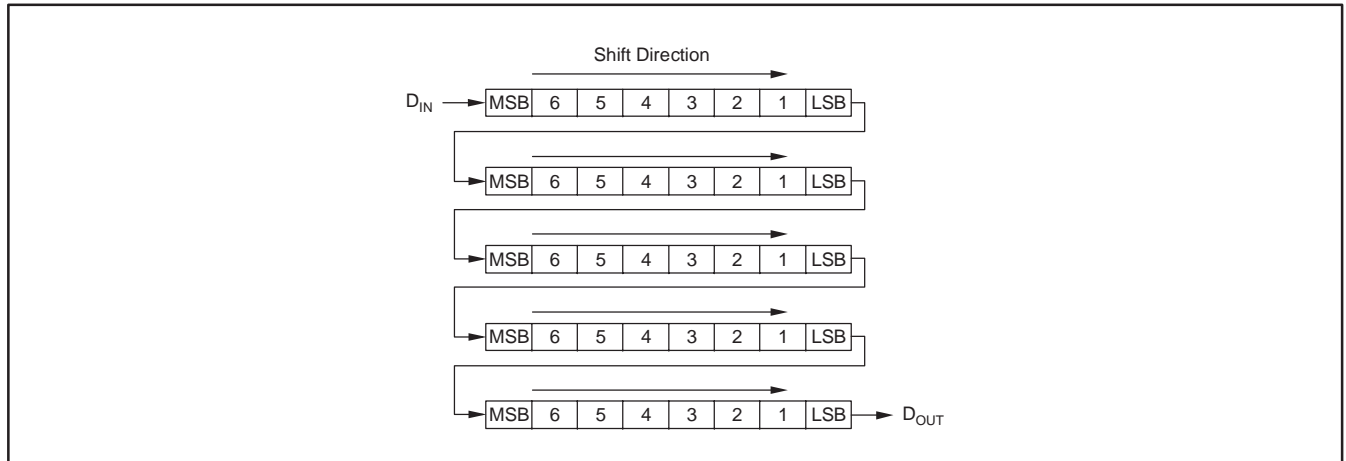

Table 1. Maximum Attenuation.

A1, A0	MAXIMUM ATTENUATION
0, 0	29dB
0, 1	33dB
1, 0	36.5dB
1, 1	40dB

Table 2. PGA Gain Settings.

PG1, PG0	PGA GAIN
00	25dB
01	30dB
10	35dB
11	40dB

Table 3. CW Coding for Each Channel.

CHANNEL	CW CODING (MSB, LSB)	CHANNEL DIRECTED TO:
0	0000	Output 0
1	0001	Output 1
2	0010	Output 2
3	0011	Output 3
4	0100	Output 4
5	0101	Output 5
6	0110	Output 6
7	0111	Output 7
8	1000	Output 8
9	1001	Output 9
10	1010	Channel tied to +V (internal)
11	1011	Channel tied to +V (internal)
12	1100	Channel tied to +V (internal)
13	1101	Channel tied to +V (internal)
14	1110	Channel tied to +V (internal)
15	1111	Channel tied to +V (internal)

Applies to bytes 2 through 5.

TYPICAL CHARACTERISTICS: $AV_{DD} = 3V$

At $T_A = +25^\circ C$, load resistance = $1k\Omega$ on each output to ground, unless otherwise noted. The input to the preamp (LNA) is single-ended; pre-amp gain is fixed at +20dB, $f_{IN} = 2MHz$, PG = 01, ATN = 00, and the output from the VCA is differential, unless otherwise noted.

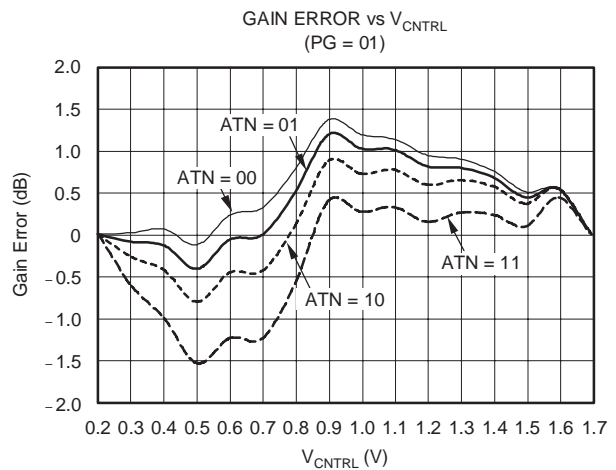
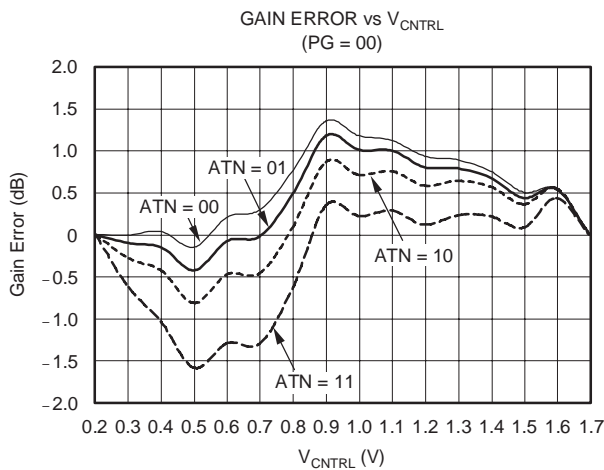
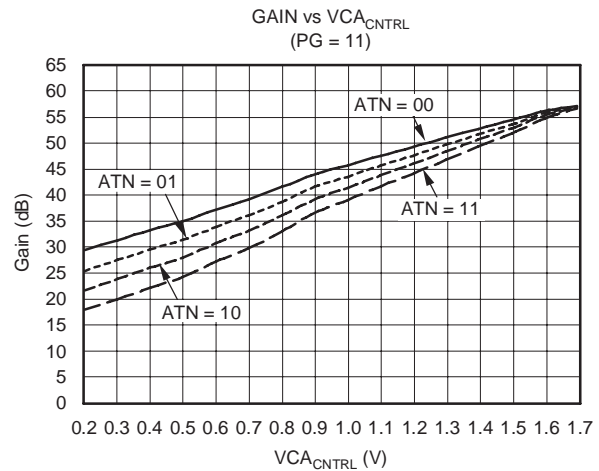
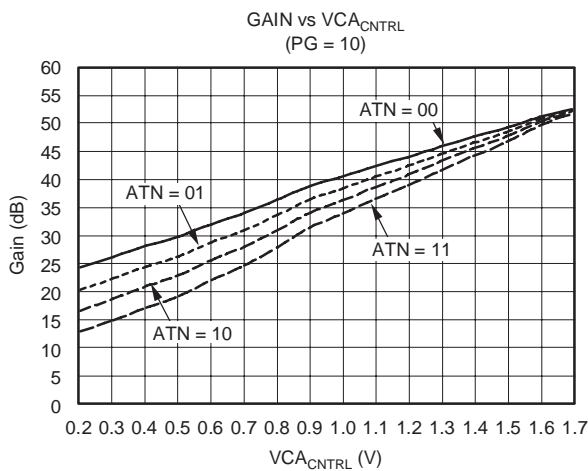
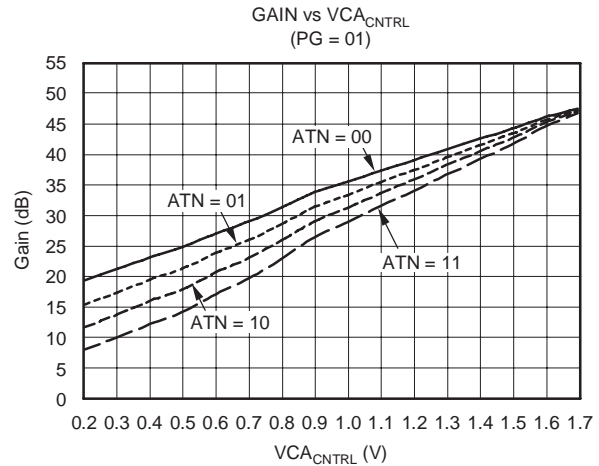
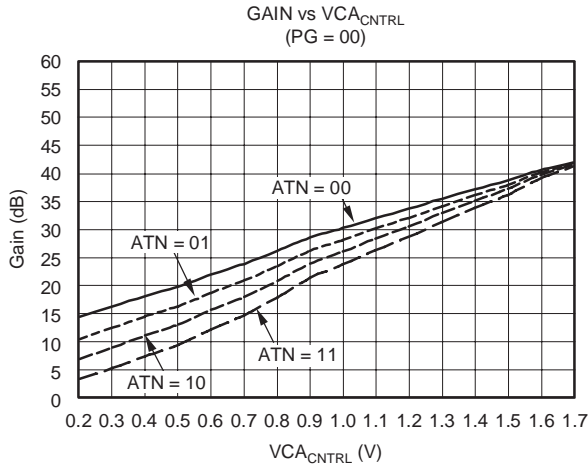

TYPICAL CHARACTERISTICS: $V_{DD} = 3V$ (continued)

At $T_A = +25^\circ C$, load resistance = $1k\Omega$ on each output to ground, unless otherwise noted. The input to the preamp (LNA) is single-ended; pre-amp gain is fixed at +20dB, $f_{IN} = 2MHz$, PG = 01, ATN = 00, and the output from the VCA is differential, unless otherwise noted.

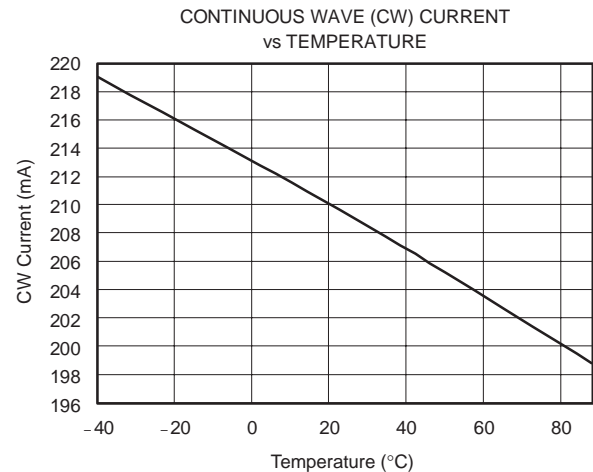
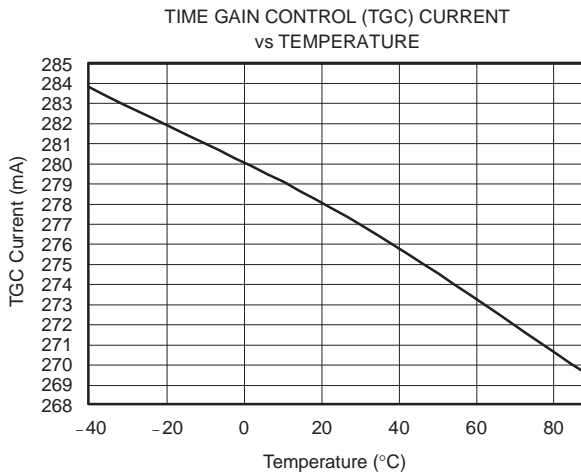
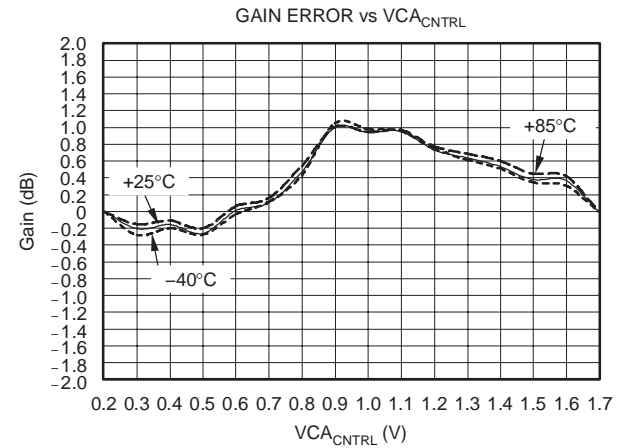
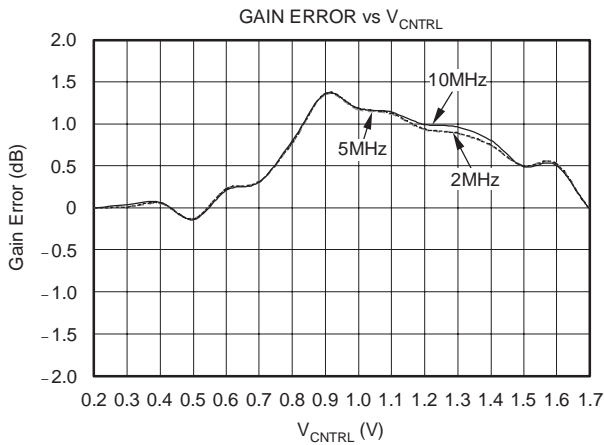
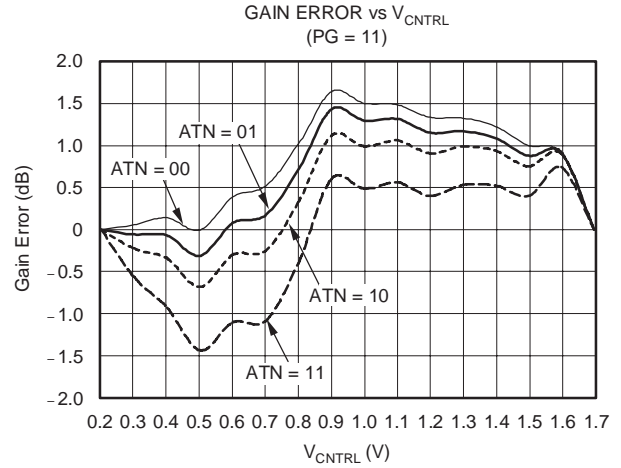
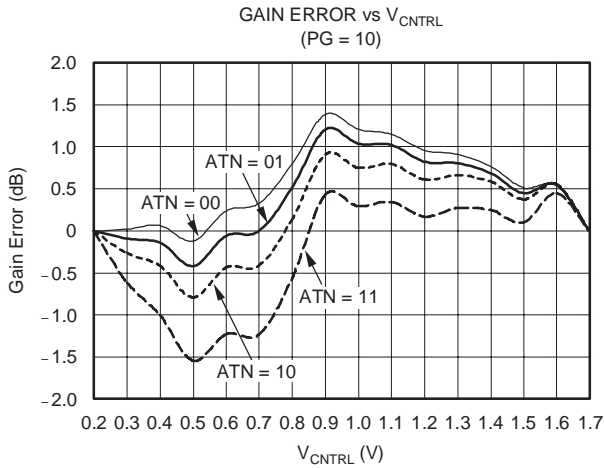

TYPICAL CHARACTERISTICS: $AV_{DD} = 3V$ (continued)

At $T_A = +25^\circ C$, load resistance = $1k\Omega$ on each output to ground, unless otherwise noted. The input to the preamp (LNA) is single-ended; pre-amp gain is fixed at $+20dB$, $f_{IN} = 2MHz$, $PG = 01$, $ATN = 00$, and the output from the VCA is differential, unless otherwise noted.

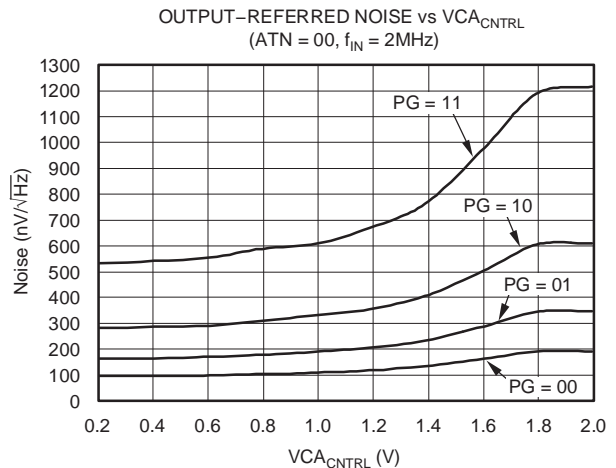
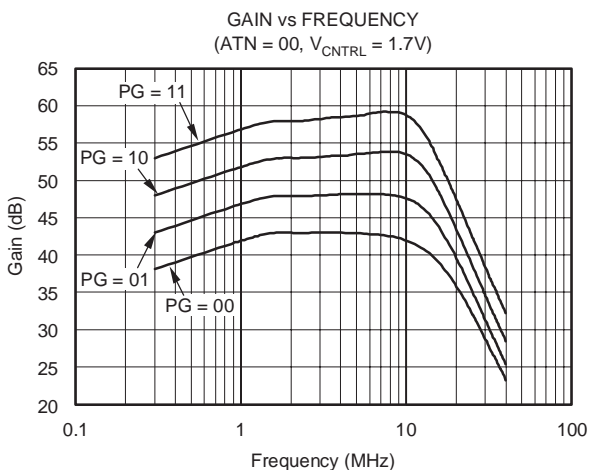
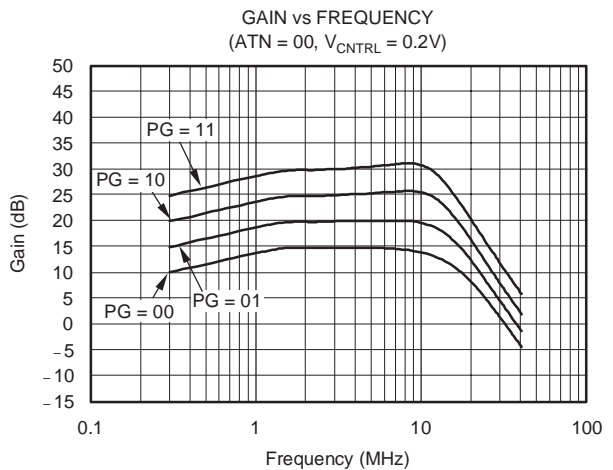
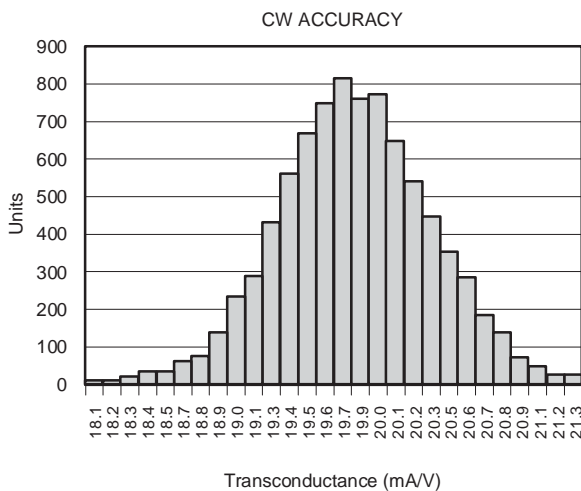
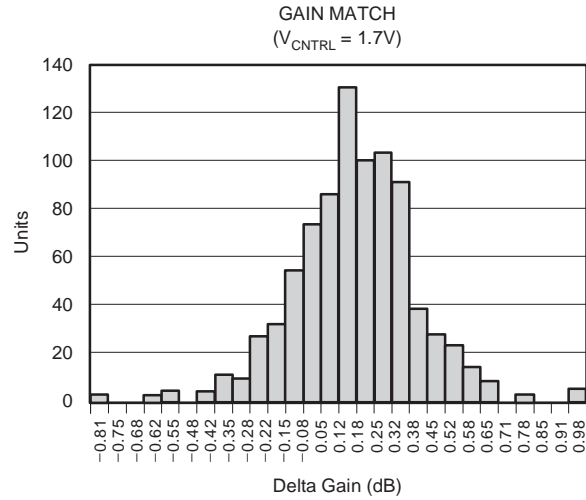
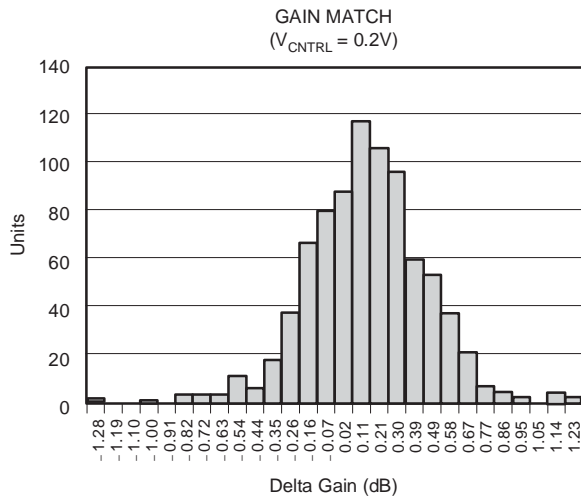

TYPICAL CHARACTERISTICS: $AV_{DD} = 3V$ (continued)

At $T_A = +25^\circ C$, load resistance = $1k\Omega$ on each output to ground, unless otherwise noted. The input to the preamp (LNA) is single-ended; pre-amp gain is fixed at +20dB, $f_{IN} = 2MHz$, PG = 01, ATN = 00, and the output from the VCA is differential, unless otherwise noted.

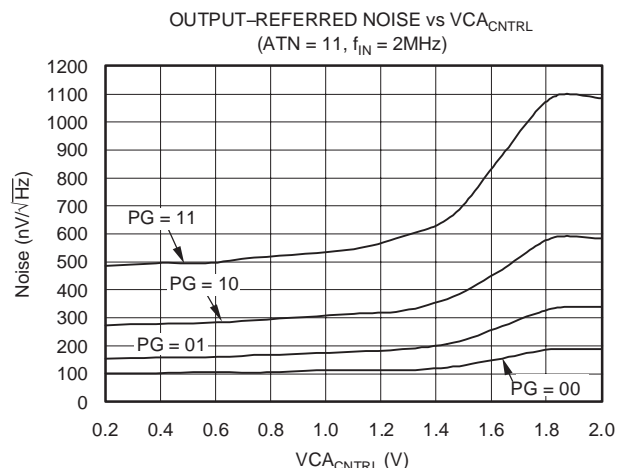
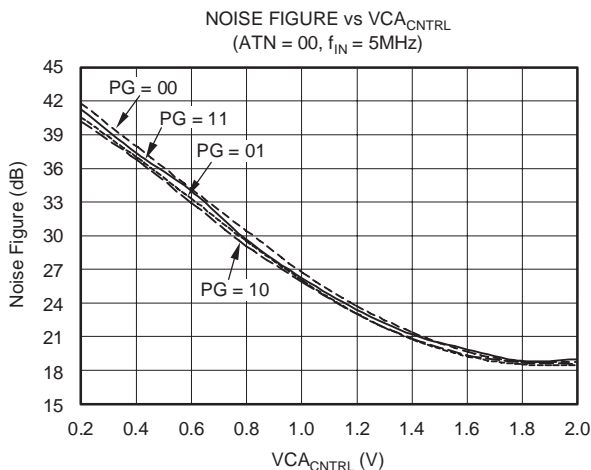
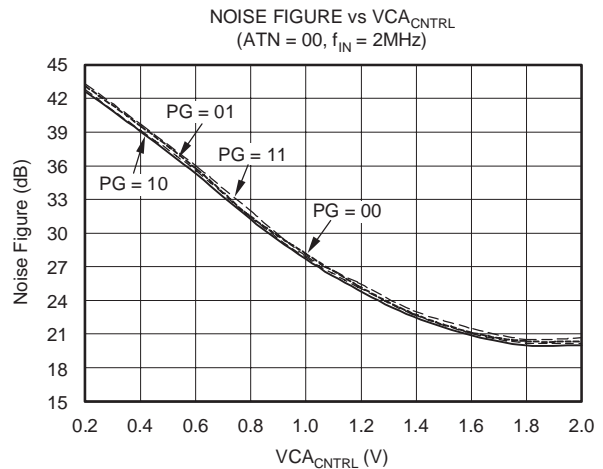
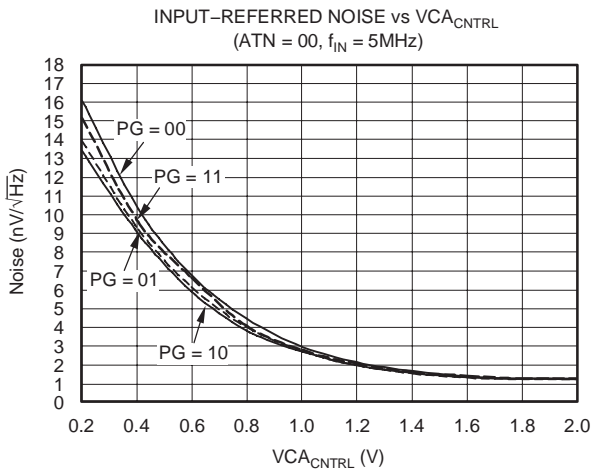
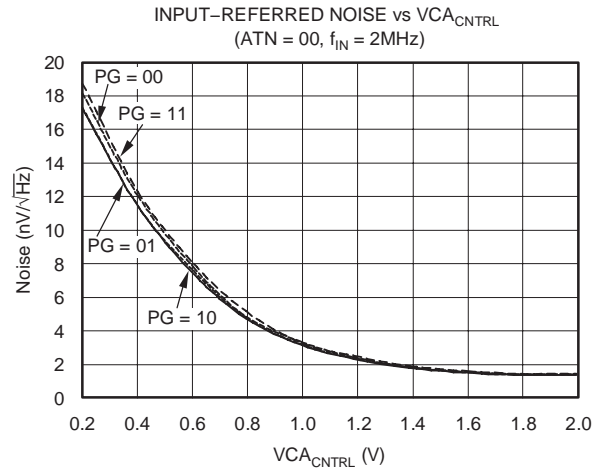
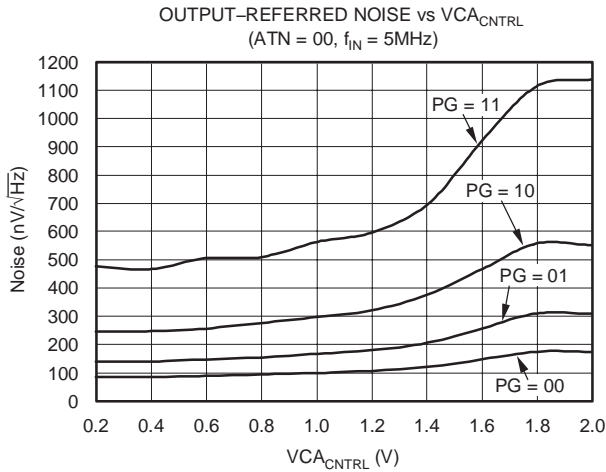

TYPICAL CHARACTERISTICS: $AV_{DD} = 3V$ (continued)

At $T_A = +25^\circ C$, load resistance = $1k\Omega$ on each output to ground, unless otherwise noted. The input to the preamp (LNA) is single-ended; pre-amp gain is fixed at +20dB, $f_{IN} = 2MHz$, PG = 01, ATN = 00, and the output from the VCA is differential, unless otherwise noted.

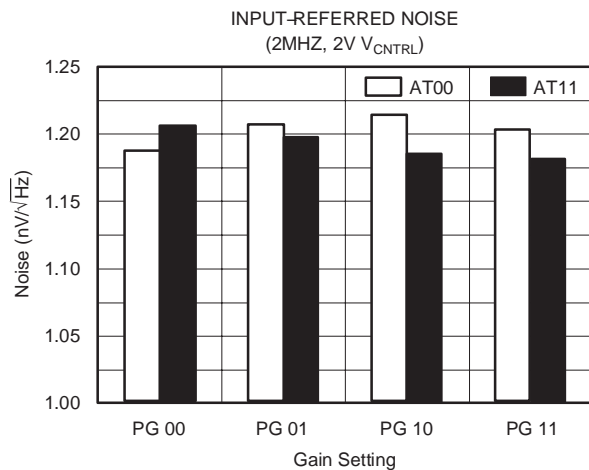
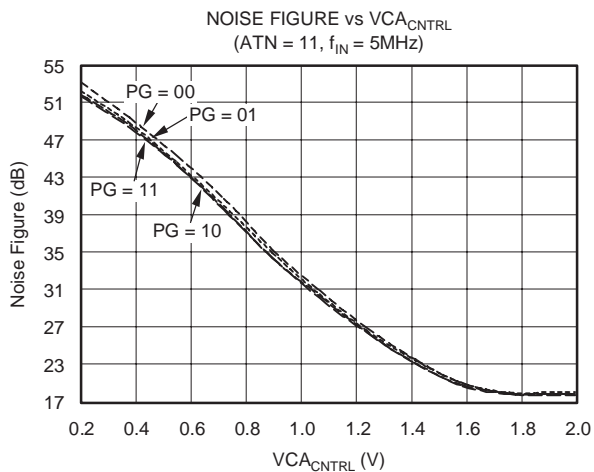
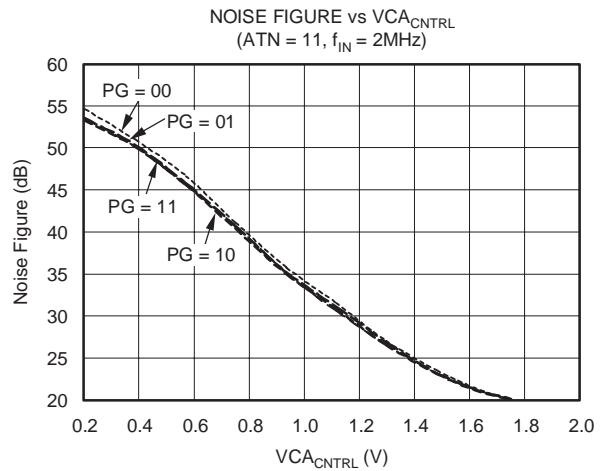
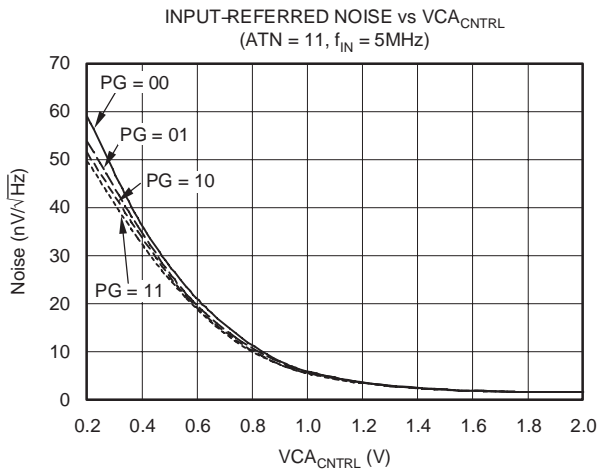
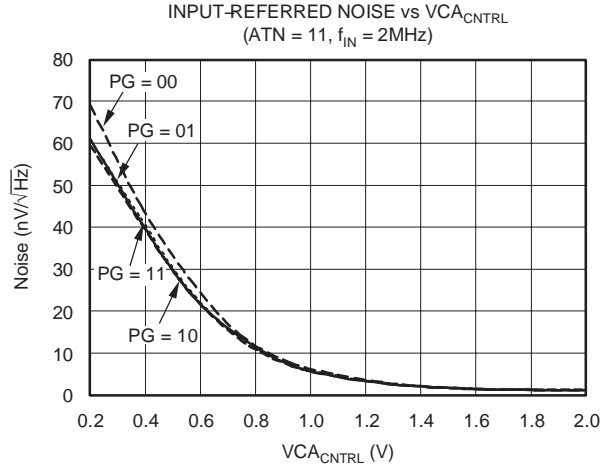
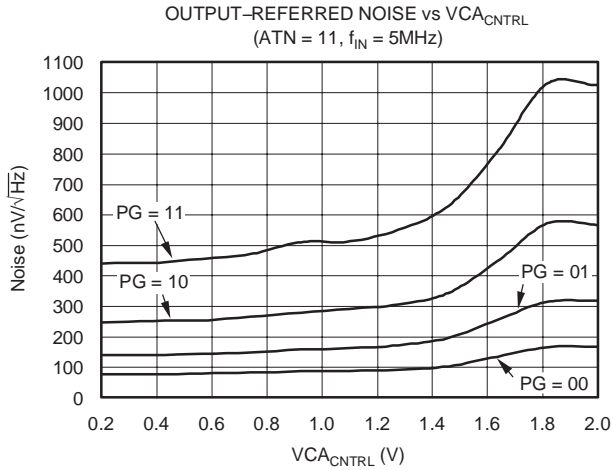

TYPICAL CHARACTERISTICS: $V_{DD} = 3V$ (continued)

At $T_A = +25^\circ C$, load resistance = $1k\Omega$ on each output to ground, unless otherwise noted. The input to the preamp (LNA) is single-ended; pre-amp gain is fixed at +20dB, $f_{IN} = 2MHz$, PG = 01, ATN = 00, and the output from the VCA is differential, unless otherwise noted.

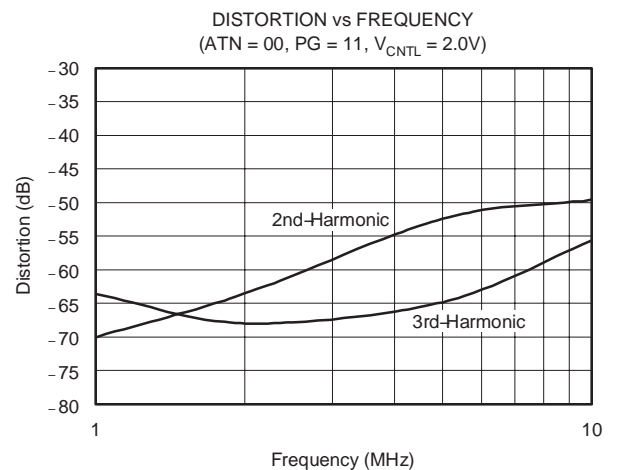
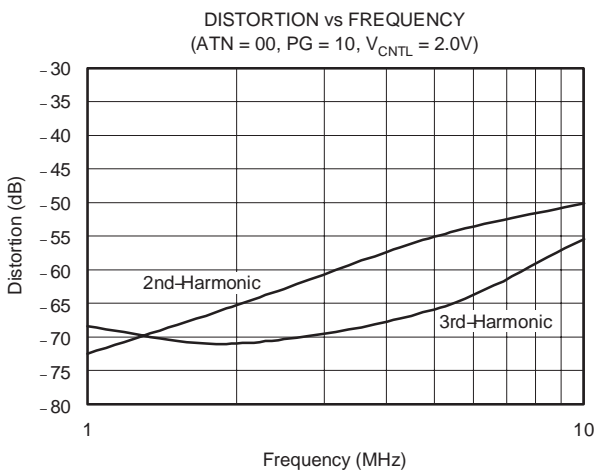
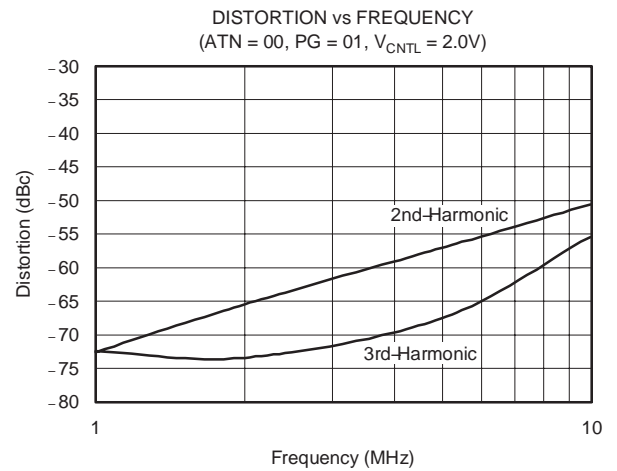
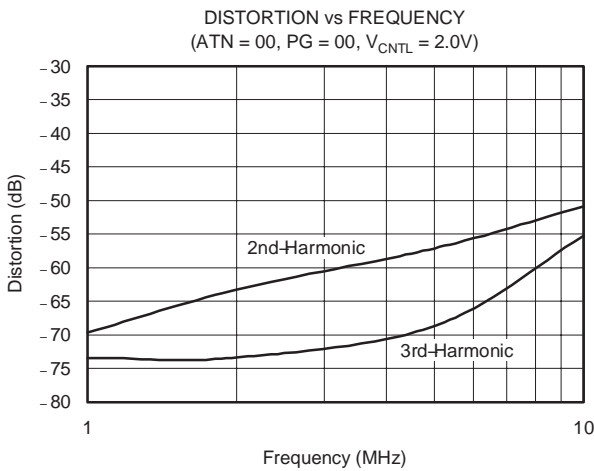
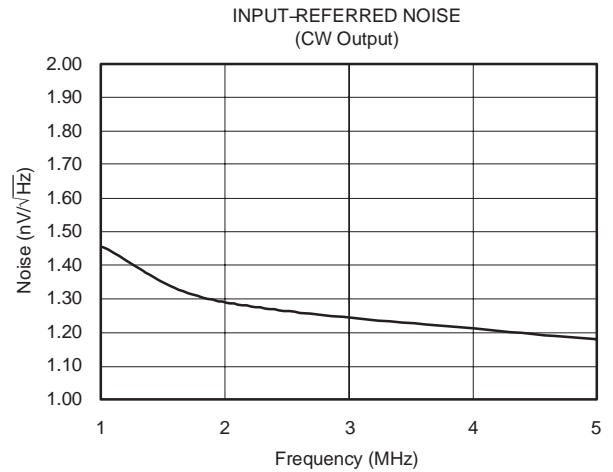
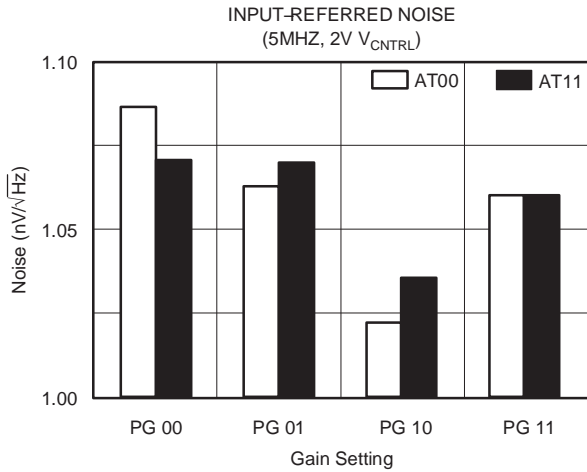

TYPICAL CHARACTERISTICS: $AV_{DD} = 3V$ (continued)

At $T_A = +25^\circ C$, load resistance = $1k\Omega$ on each output to ground, unless otherwise noted. The input to the preamp (LNA) is single-ended; pre-amp gain is fixed at $+20dB$, $f_{IN} = 2MHz$, $PG = 01$, $ATN = 00$, and the output from the VCA is differential, unless otherwise noted.

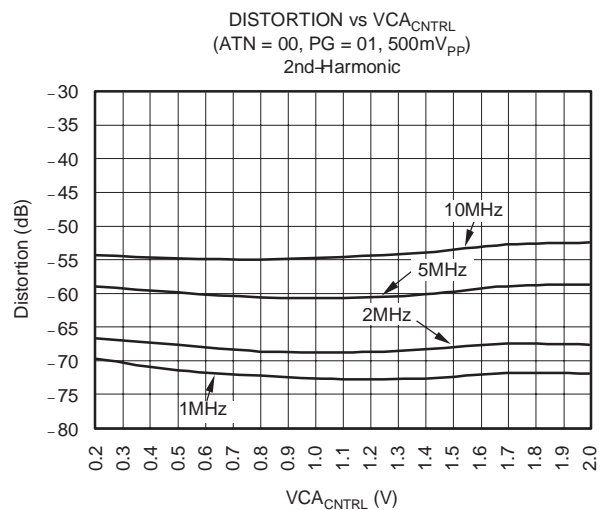
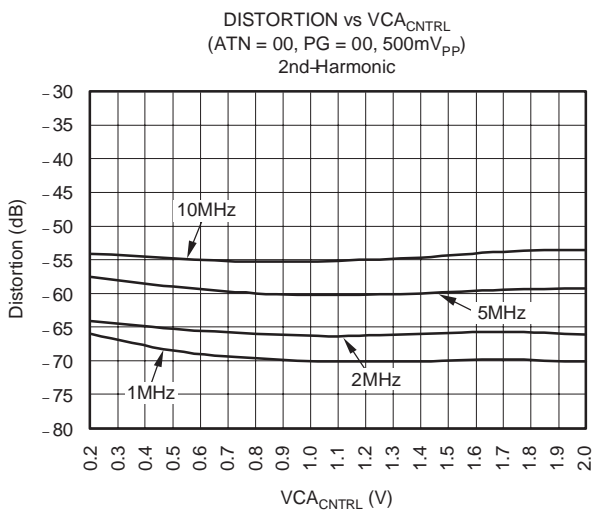
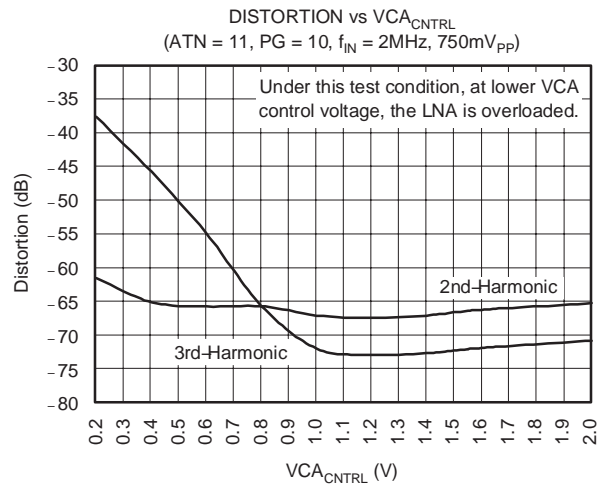
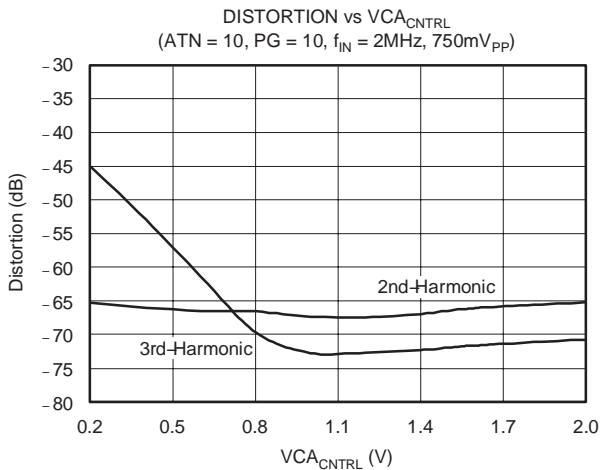
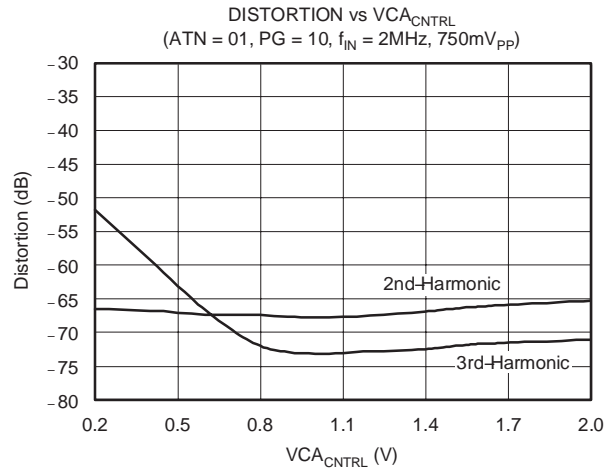
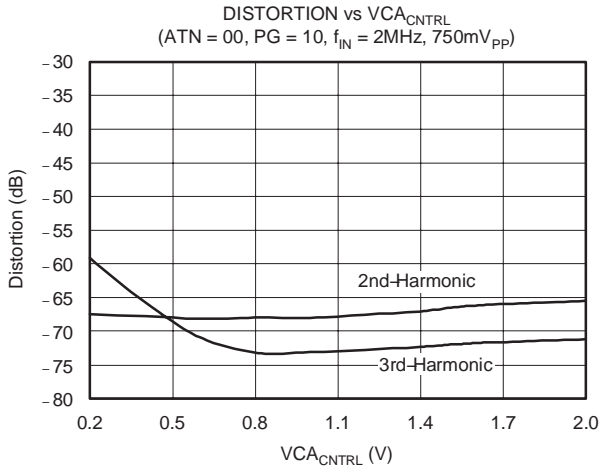

TYPICAL CHARACTERISTICS: $AV_{DD} = 3V$ (continued)

At $T_A = +25^\circ C$, load resistance = $1k\Omega$ on each output to ground, unless otherwise noted. The input to the preamp (LNA) is single-ended; pre-amp gain is fixed at $+20dB$, $f_{IN} = 2MHz$, $PG = 01$, $ATN = 00$, and the output from the VCA is differential, unless otherwise noted.

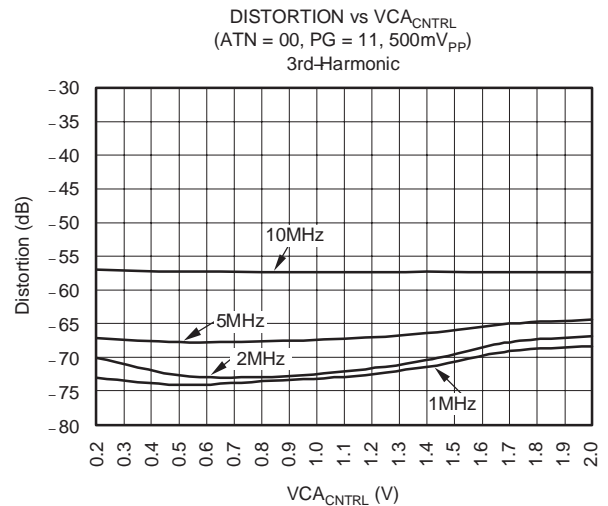
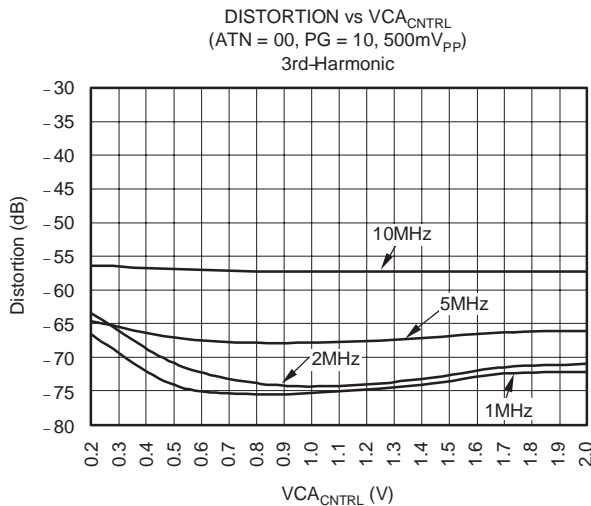
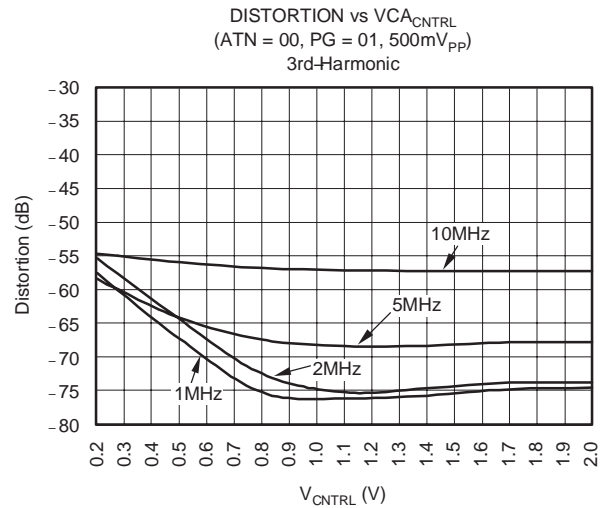
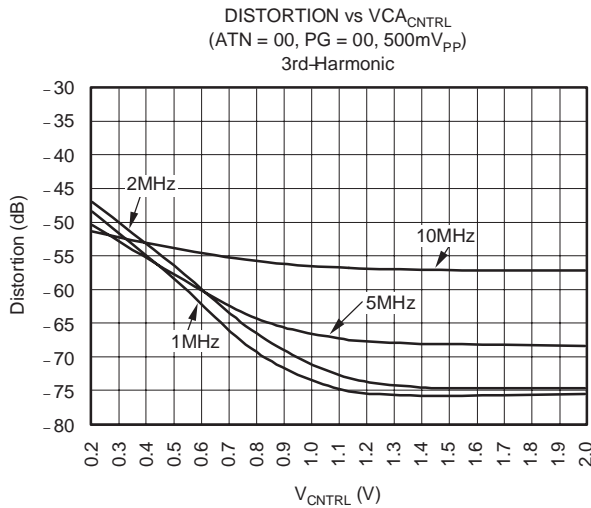
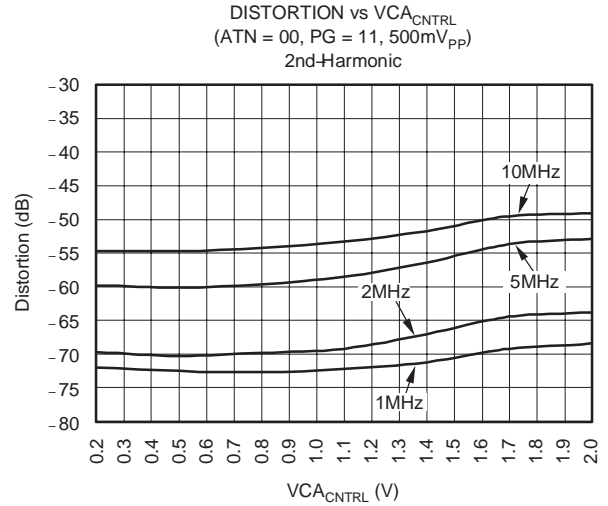
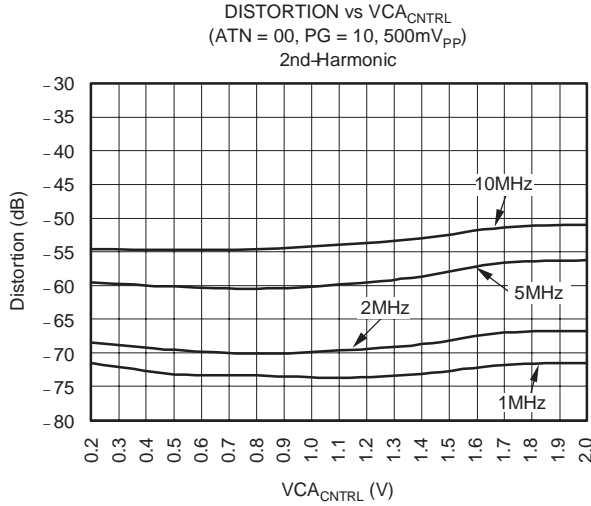

TYPICAL CHARACTERISTICS: $AV_{DD} = 3V$ (continued)

At $T_A = +25^\circ C$, load resistance = $1k\Omega$ on each output to ground, unless otherwise noted. The input to the preamp (LNA) is single-ended; pre-amp gain is fixed at $+20dB$, $f_{IN} = 2MHz$, $PG = 01$, $ATN = 00$, and the output from the VCA is differential, unless otherwise noted.

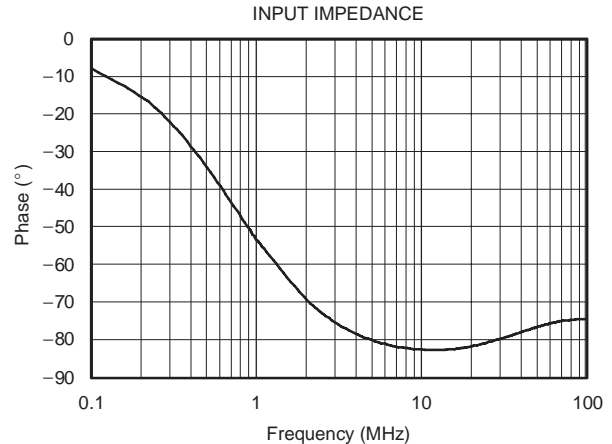
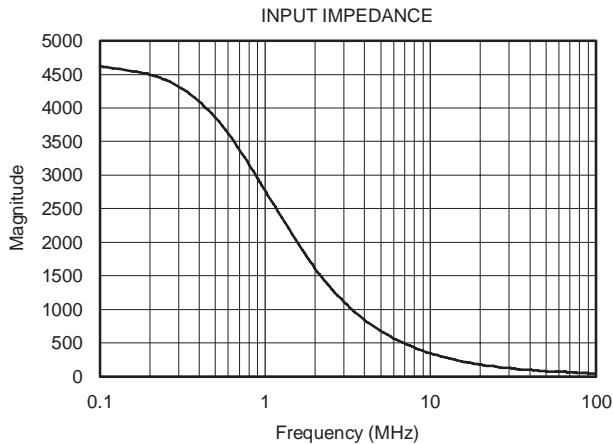
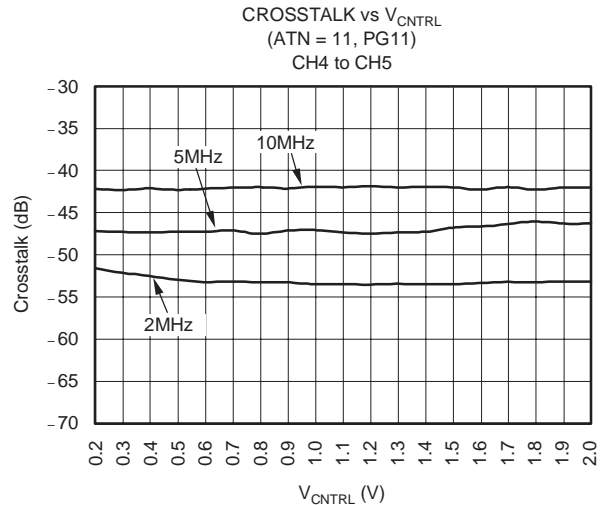
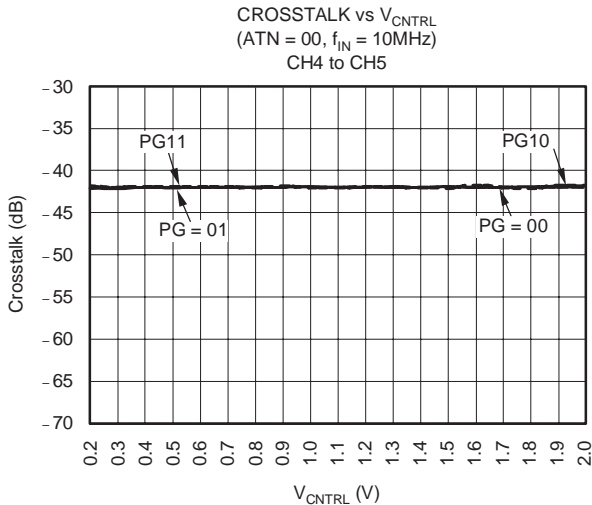
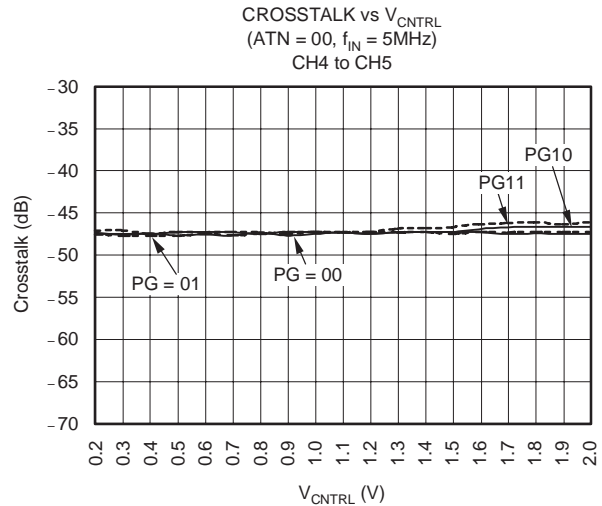
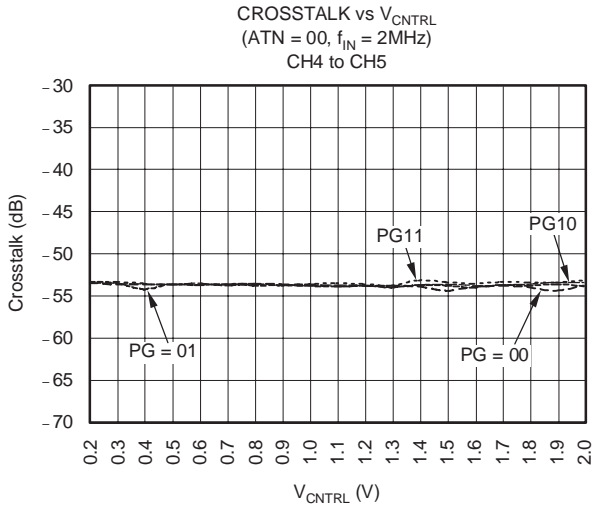

TYPICAL CHARACTERISTICS: $AV_{DD} = 3V$ (continued)

At $T_A = +25^\circ C$, load resistance = $1k\Omega$ on each output to ground, unless otherwise noted. The input to the preamp (LNA) is single-ended; pre-amp gain is fixed at +20dB, $f_{IN} = 2MHz$, $PG = 01$, $ATN = 00$, and the output from the VCA is differential, unless otherwise noted.

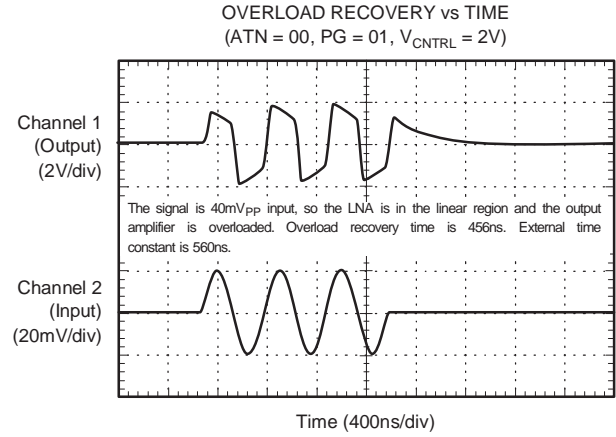
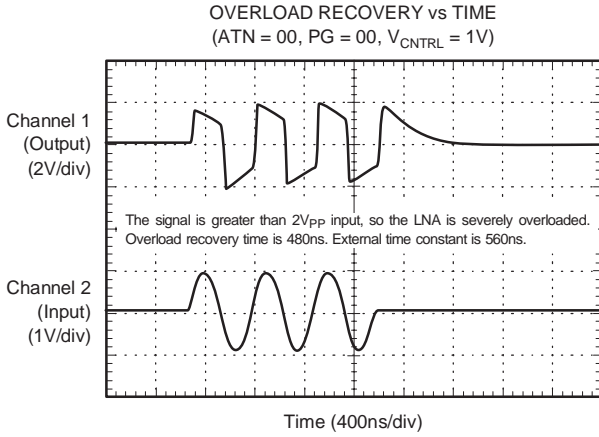

APPLICATIONS INFORMATION

NOTE: For current users of the VCA8613 who are switching to the VCA8617, pin 32 of the VCA8617 is a V_{DD} reference pin and requires a minimum 0.1 μ F bypass capacitor to ground.

INPUT CIRCUIT

The input of the VCA8617 integrates several commonly-used elements. Prior to reaching the input of the VCA, the receive signal should be coupled with a capacitor of at least 1nF (preferably more). When this AC-coupling element is inserted, the LNA input bias point is held to a common-mode value of 2.4V by an integrated 4.5k Ω resistor. This common-mode value will change with temperature and may also vary from chip to chip, but for each chip, it will be held constant. In parallel with this resistor are two back-to-back clipping diodes. These diodes prevent excessive input voltages from passing through to the LNA input, preventing deep saturation effects in the LNA itself.

LOW-NOISE PRE-AMPLIFIER (LNA)

The VCA8617 integrates a low-noise pre-amplifier. Because of the high level of integration in the system, noise performance was traded for power consumption, resulting in an extremely low-power pre-amplifier, with 0.8nV/ $\sqrt{\text{Hz}}$ noise performance at 5MHz. The LNA is configured as a fixed-gain 20dB amplifier. Of this total gain, 6dB results from the single-ended to differential

conversion accomplished within the LNA itself. The output of the LNA is limited to a little over 2V differential swing. This implies a maximum input voltage swing of approximately 200mV to be operating in the linear range at 5MHz. Larger input signals can be accepted by the LNA, but distortion performance will degrade with high-level input signals.

CW DOPPLER PROCESSOR

The VCA8617 integrates many of the elements necessary to allow for the implementation of a simple CW Doppler processing circuit. One circuit that was integrated was a V/I converter following the LNA (see Figure 1). The V/I converter converts the differential LNA voltage output to a current, which is then passed through an 8x10 switch matrix (see Figure 2). Within this switch matrix, any of the eight LNA outputs can be connected to any of ten CW output pins. This is a simple current-summing circuit, such that each CW output can represent the sum of any or all the channel currents. The transconductance of the V/I converter is approximately 20mA/V relative to the LNA input. For proper operation of the CW Doppler Processor, it is mandatory to have a bias on the output/outputs that are selected (see Figure 3).

The CW output common-mode is 1.4V.

The CW outputs are typically routed to a passive delay line, allowing coherent summing of the signals. After summing, IQ separation and down conversion to base band precedes a pair of high-resolution, low sample rate ADCs.

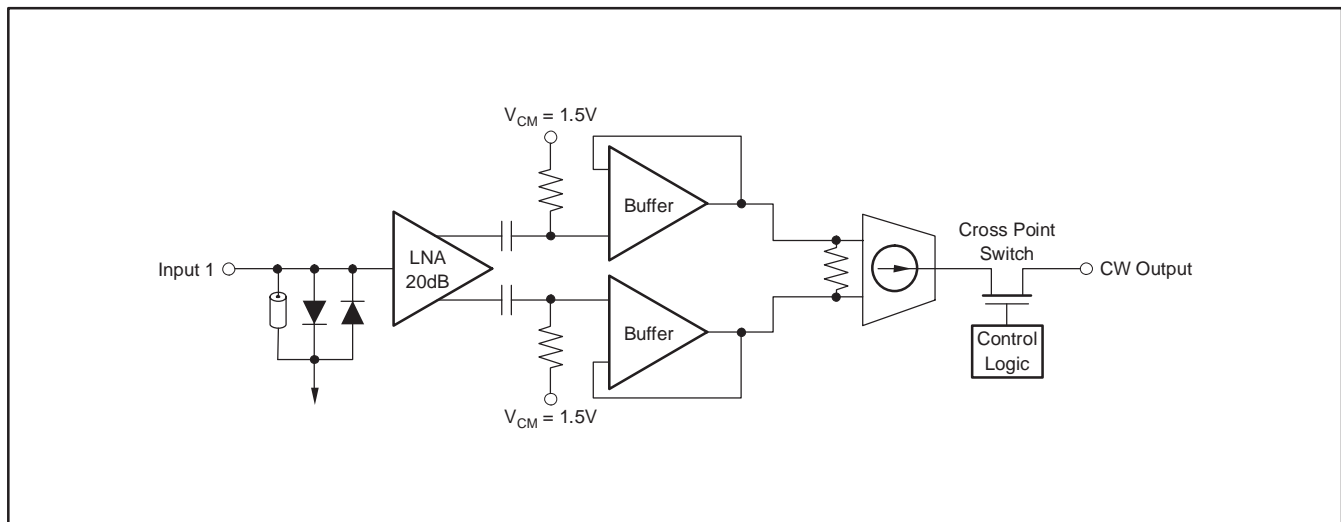

Figure 1. Basic CW Processing Block Diagram.

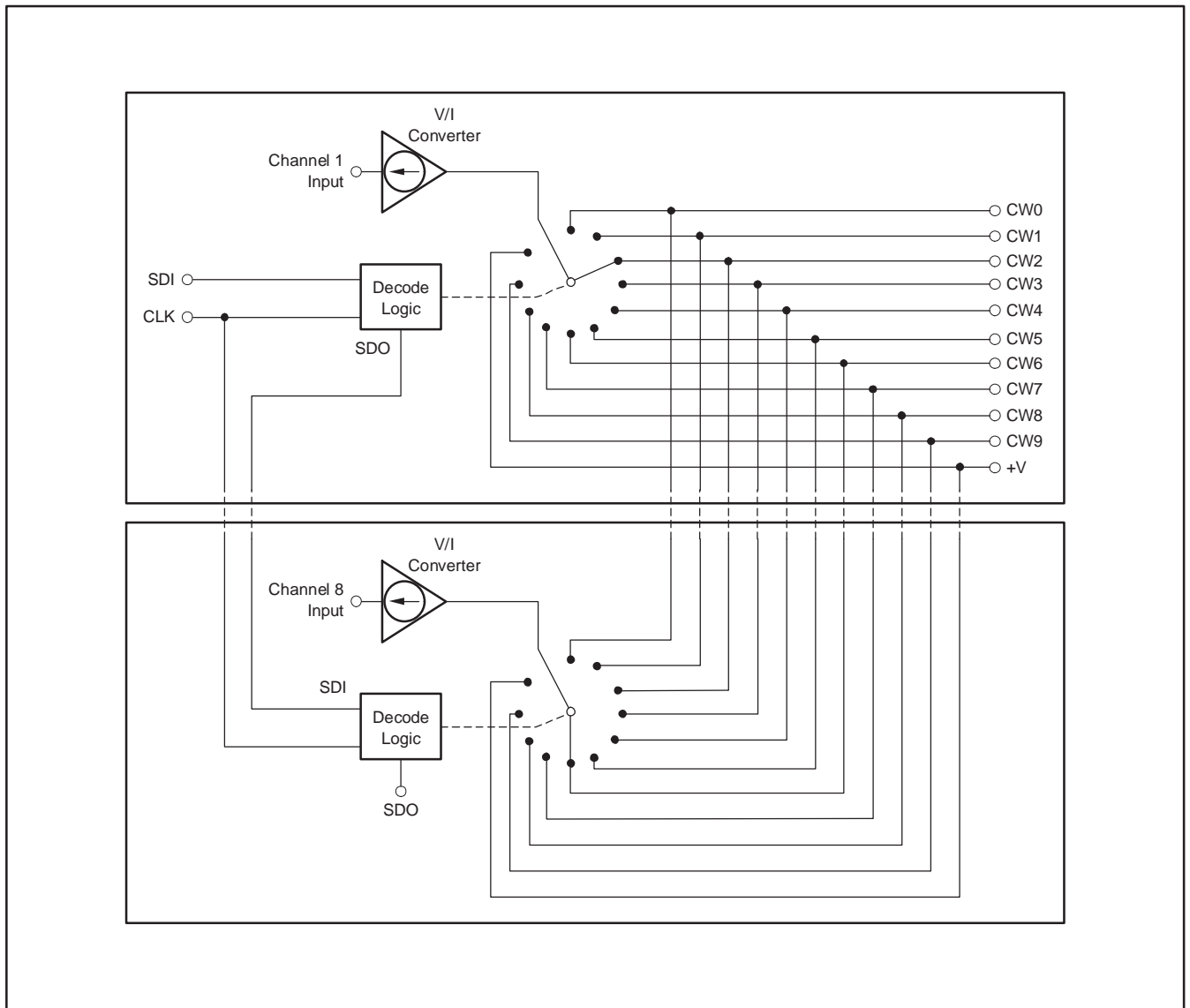

Figure 2. Basic CW Cross-point Switch Matrix for All Eight Channels.

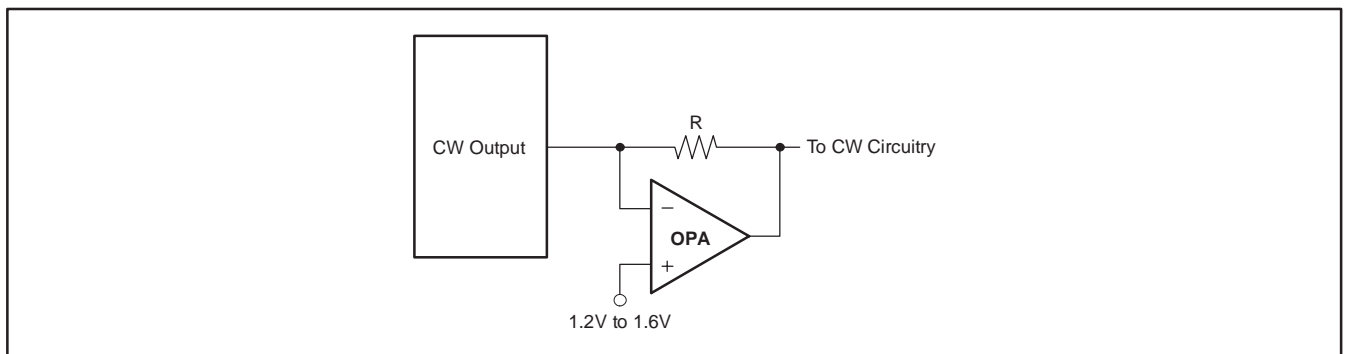

Figure 3. Operational Amplifier.

VOLTAGE-CONTROLLED ATTENUATOR (VCA)—DETAIL

The VCA is designed to have a dB-linear attenuation characteristic; that is, the gain loss in dB is constant for each equal increment of the VCA_{CTRL} control voltage. Figure 4 shows a block diagram of the VCA. The attenuator is essentially a variable voltage divider consisting of one series input resistor, R_S , and ten identical shunt FETs, placed in parallel and controlled by sequentially-activated clipping amplifiers. Each clipping amplifier can be thought of as a specialized voltage comparator with a soft transfer characteristic and well-controlled output limit voltages. The reference voltages V1 through V10 are equally spaced over the 0V to 1.8V control voltage range. As the control voltage rises through the input range of each clipping amplifier, the amplifier output will rise from 0V (FET completely ON) to $V_{CM} - V_T$ (FET nearly OFF), where V_{CM} is the common source voltage and V_T is the threshold voltage of the FET. As each FET approaches its OFF state and the control voltage continues to rise, the next clipping amplifier/FET combination takes over for the next portion of the piecewise-linear attenuation characteristic. Thus, low control voltages have most of the FETs turned ON, while high control voltages have most turned OFF. Each FET acts to decrease the shunt resistance of the voltage divider formed by R_S and the parallel FET network.

The attenuator is comprised of two sections, with five parallel clipping amplifier/FET combinations in each. Special reference circuitry is provided so that the $(V_{CM} - V_T)$ limit voltage will track temperature and IC process variations, minimizing the effects on the attenuator control characteristic.

In addition to the analog VCA_{CTRL} gain setting input, the attenuator architecture provides digitally- programmable adjustment in eight steps, via the two attenuation bits. These adjust the maximum achievable gain (corresponding to minimum attenuation in the VCA, with $VCA_{CTRL} = 1.8V$) in 5dB increments. This function is accomplished by providing multiple FET sub-elements for each of the Q_1 to Q_{10} FET shunt elements (see Figure 5). In the simplified diagram of Figure 4, each

shunt FET is shown as two sub-elements, Q_{NA} and Q_{NB} . Selector switches, driven by the MGS bits, activate either or both of the sub-element FETs to adjust the maximum R_{ON} and thus achieve the stepped attenuation options.

The VCA can be used to process either differential or single-ended signals. Fully differential operation will reduce 2nd-harmonic distortion by about 10dB for full-scale signals.

Input impedance of the VCA will vary with gain setting, because of the changing resistances of the programmable voltage divider structure. At large attenuation factors (that is, low gain settings), the impedance will approach the series resistor value of approximately 120Ω.

As with the LNA stage, the VCA output is AC-coupled into the PGA. This means that the attenuation- dependent DC common-mode voltage will not propagate into the PGA, and so the PGA DC output level will remain constant.

Finally, note that the VCA_{CTRL} input consists of FET gate inputs. This provides very high impedance and ensures that multiple VCA8617 devices may be connected in parallel with no significant loading effects. The nominal voltage range for the VCA_{CTRL} input spans from 0V to 1.8V. Overdriving this input ($> 3V$) does not affect the performance.

PGA POST-AMPLIFIER

Figure 6 shows a simplified circuit diagram of the PGA. PGA gain is programmed through the serial port, and can be configured to 24 different gain settings of 24dB, 29dB, 34dB, and 39dB, as shown in Table 4. A patented circuit has been implemented in the PGA that allows for exceptional overload signal recovery.

Table 4. PGA Gain Settings.

PGA	GAIN
00	25
01	30
10	35
11	40

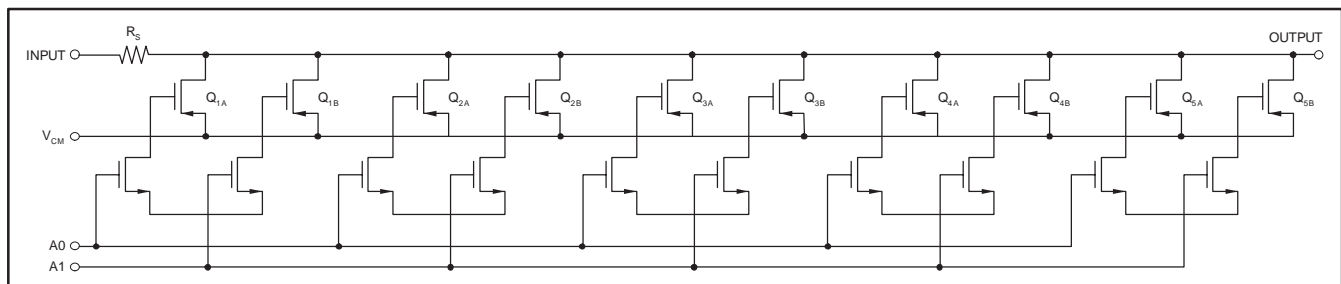

Figure 4. Programmable Attenuator Section.

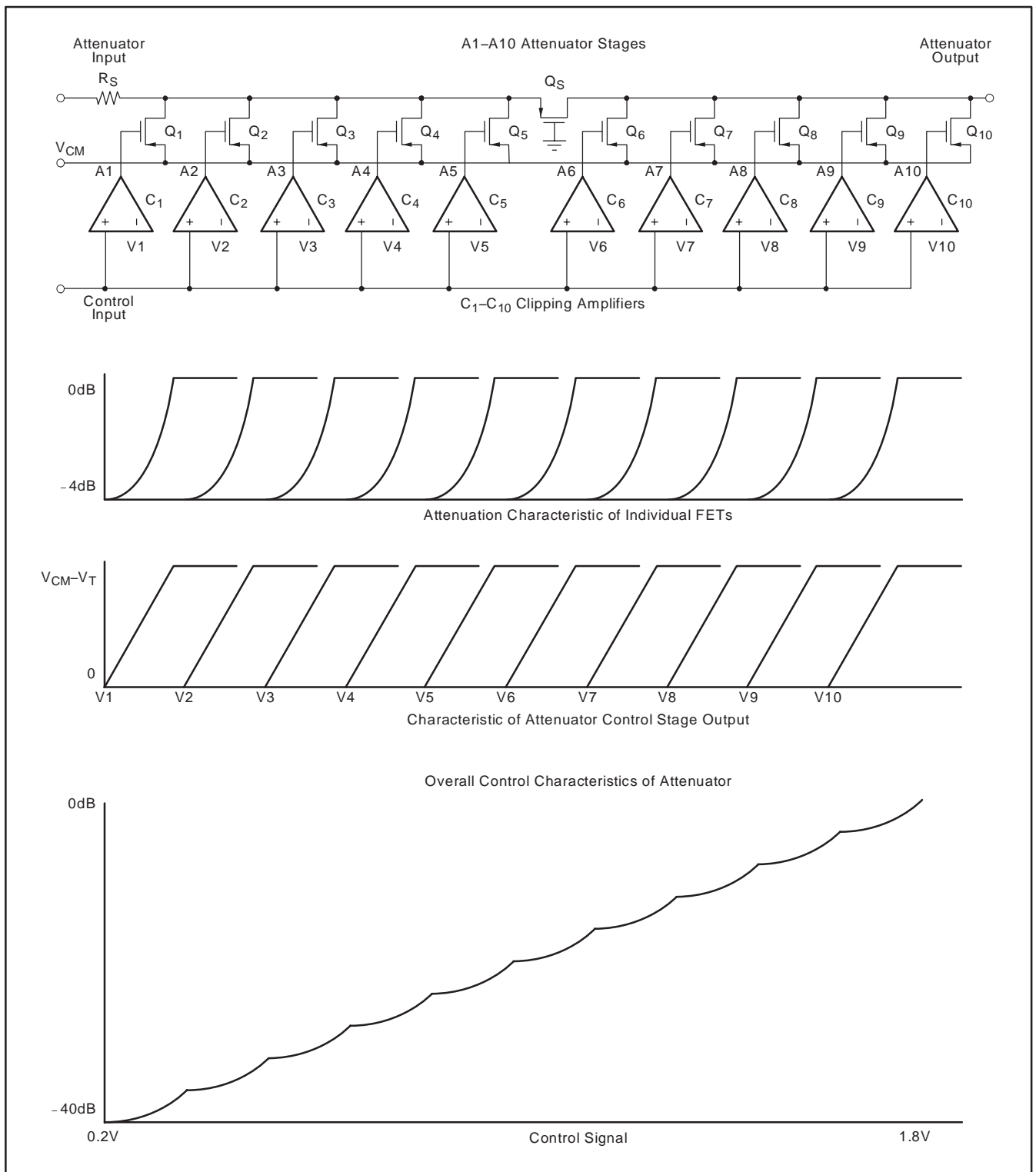

Figure 5. Piecewise Approximation to Logarithmic Control Characteristics.

OUTPUT FILTER

The VCA8617 integrates a two-pole, 15MHz low-pass Butterworth filter in the output stage. The cutoff frequency is implemented with passive semiconductor elements and as such, the cutoff frequency will not be precise. The output pins of the VCA8617, as shown in Figure 6, nominally sit at approximately $1.5V_{DC}$. However, this DC voltage varies slightly over PG gain settings as well as from chip to chip as a result of process variations. For users who cannot tolerate this slight variation, an AC coupling capacitor is recommended between the VCA outputs and the ADC inputs. The smaller the value of this capacitor, the better, because it reduces the pulse signal settling time. For the typical performance charts in this datasheet, a 560pF capacitor was used.

SERIAL INTERFACE

The serial interface of the VCA8617 allows flexibility in the use of the part. The following parameters are set from the serial control registers:

- Mode
 - TGC Mode
 - CW Mode
- Attenuation Range
- PGA Gain
- Power-Down (this is the default state in which the VCA8617 initializes)
- CW Output Selection For Each Input Channel

The serial interface uses an SPI style of interface format. The Input Register Bit Maps (see page 5) show the functionality of each control register.

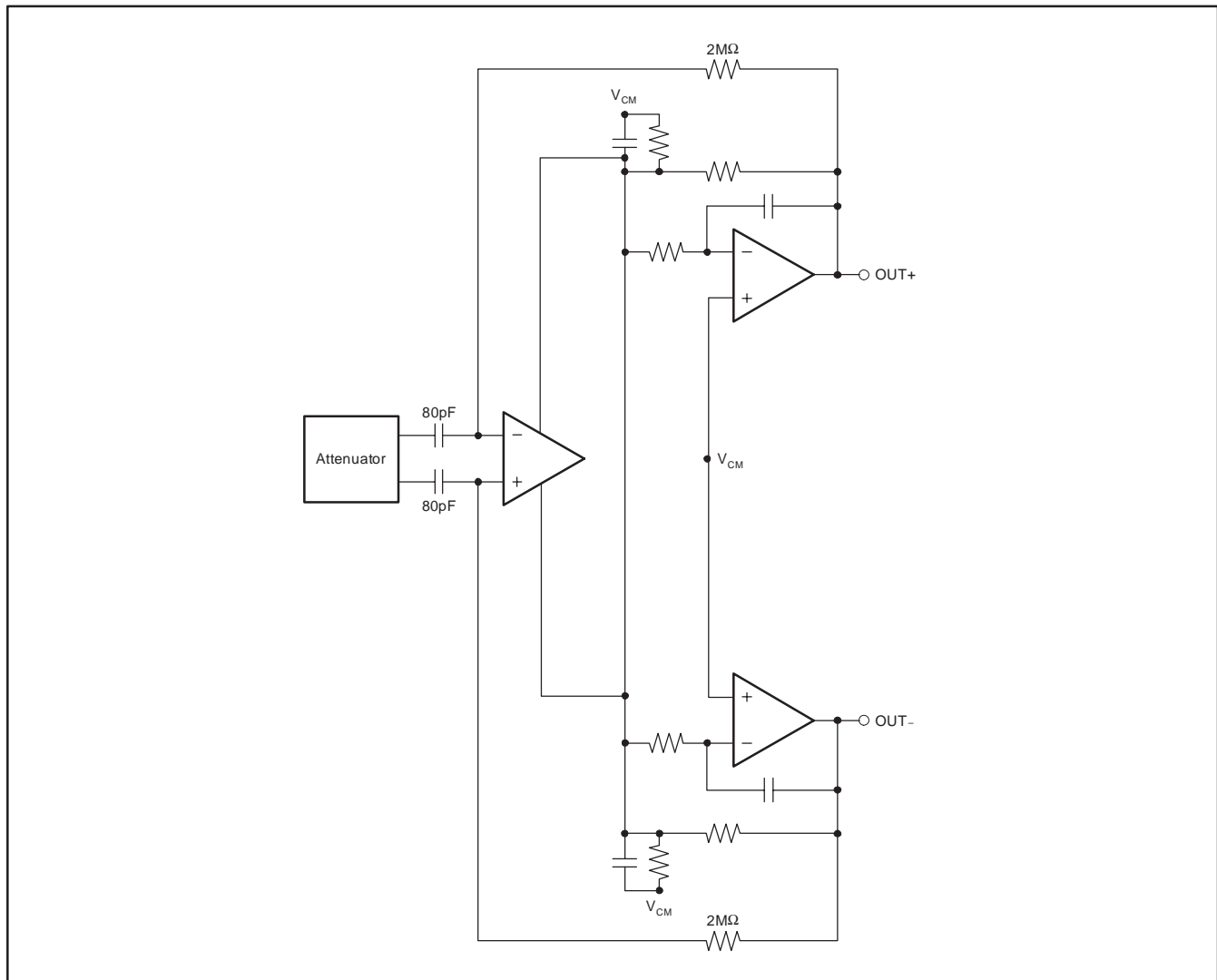

Figure 6. Simplified PGA and Output Filter Circuit.

LAYOUT CONSIDERATIONS

The VCA8617 is a multi-channel amplifier capable of high gains that has integrated digital controls. Layout of the VCA8617 is fairly straightforward. By connecting all of the grounds (including the digital grounds) to the analog ground, noise performance will help to be

maintained. The analog ground should be a solid plane. Power-supply decoupling and decoupling of the control voltage (VCA_{CTRL}) pin are essential in order to ensure that the noise performance be maintained. For further help in determining basic values, please refer to Figure 7.

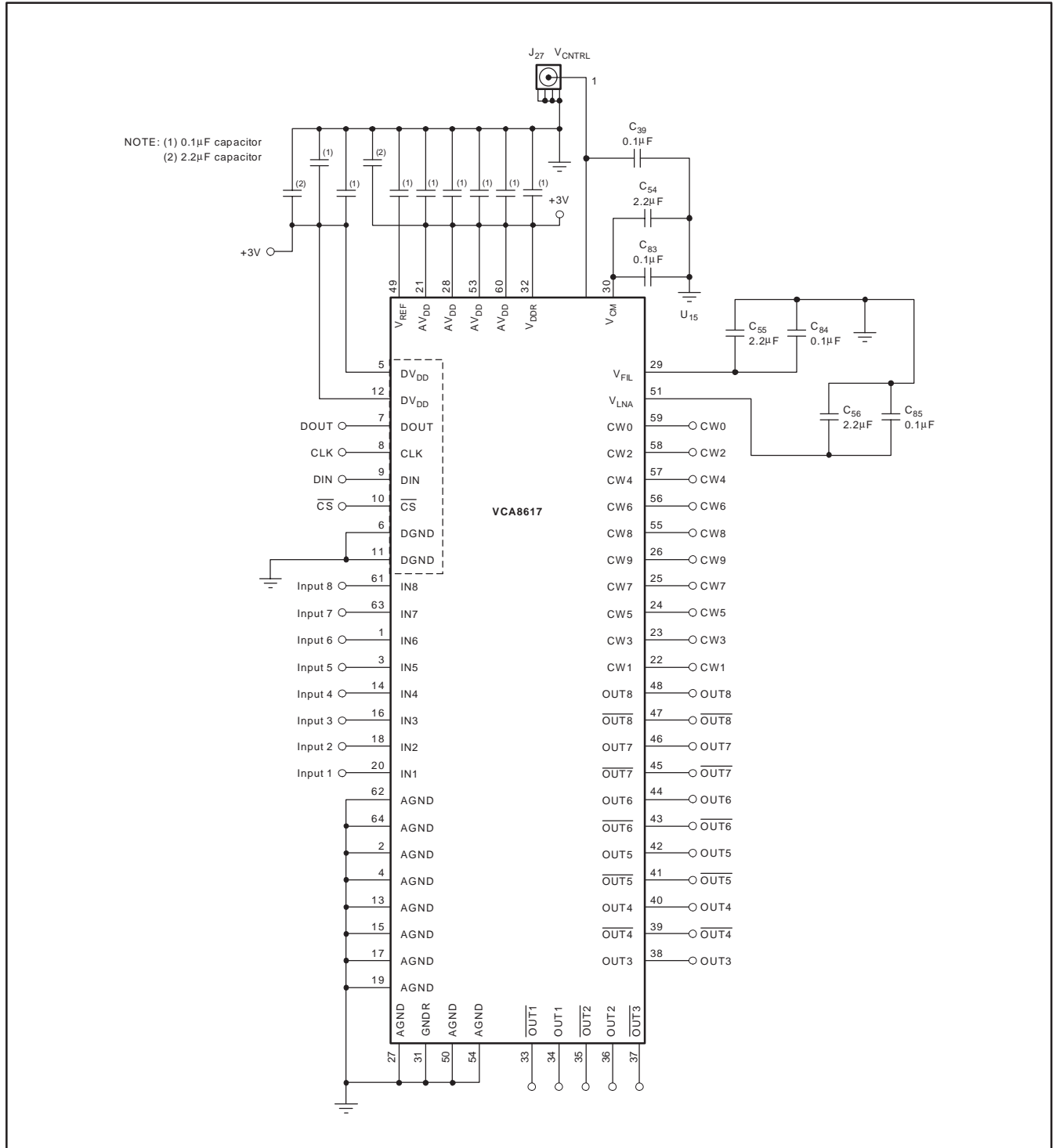

Figure 7. Basic Connection Diagram.

PACKAGING INFORMATION

Orderable Device	Status ⁽¹⁾	Package Type	Package Drawing	Pins	Package Qty	Eco Plan ⁽²⁾	Lead/Ball Finish	MSL Peak Temp ⁽³⁾
VCA8617PAGR	ACTIVE	TQFP	PAG	64	1500	None	CU SNPB	Level-3-240C-168 HR
VCA8617PAGT	ACTIVE	TQFP	PAG	64	250	None	CU SNPB	Level-3-240C-168 HR

⁽¹⁾ The marketing status values are defined as follows:

ACTIVE: Product device recommended for new designs.

LIFEBUY: TI has announced that the device will be discontinued, and a lifetime-buy period is in effect.

NRND: Not recommended for new designs. Device is in production to support existing customers, but TI does not recommend using this part in a new design.

PREVIEW: Device has been announced but is not in production. Samples may or may not be available.

OBsolete: TI has discontinued the production of the device.

⁽²⁾ Eco Plan - May not be currently available - please check <http://www.ti.com/productcontent> for the latest availability information and additional product content details.

None: Not yet available Lead (Pb-Free).

Pb-Free (RoHS): TI's terms "Lead-Free" or "Pb-Free" mean semiconductor products that are compatible with the current RoHS requirements for all 6 substances, including the requirement that lead not exceed 0.1% by weight in homogeneous materials. Where designed to be soldered at high temperatures, TI Pb-Free products are suitable for use in specified lead-free processes.

Green (RoHS & no Sb/Br): TI defines "Green" to mean "Pb-Free" and in addition, uses package materials that do not contain halogens, including bromine (Br) or antimony (Sb) above 0.1% of total product weight.

⁽³⁾ MSL, Peak Temp. -- The Moisture Sensitivity Level rating according to the JEDEC industry standard classifications, and peak solder temperature.

Important Information and Disclaimer: The information provided on this page represents TI's knowledge and belief as of the date that it is provided. TI bases its knowledge and belief on information provided by third parties, and makes no representation or warranty as to the accuracy of such information. Efforts are underway to better integrate information from third parties. TI has taken and continues to take reasonable steps to provide representative and accurate information but may not have conducted destructive testing or chemical analysis on incoming materials and chemicals. TI and TI suppliers consider certain information to be proprietary, and thus CAS numbers and other limited information may not be available for release.

In no event shall TI's liability arising out of such information exceed the total purchase price of the TI part(s) at issue in this document sold by TI to Customer on an annual basis.

MECHANICAL DATA

MTQF006A – JANUARY 1995 – REVISED DECEMBER 1996

PAG (S-PQFP-G64)

PLASTIC QUAD FLATPACK

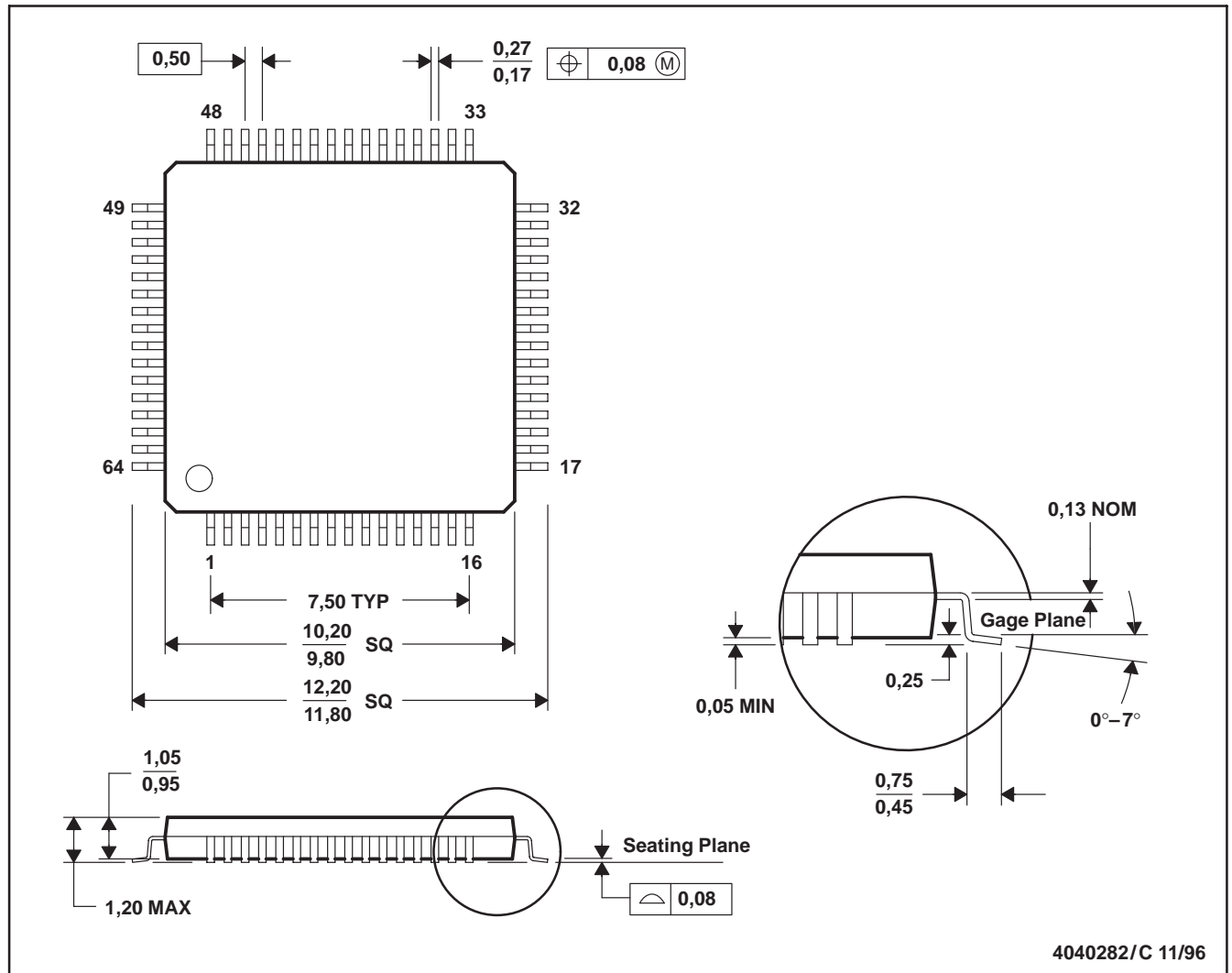

- NOTES: A. All linear dimensions are in millimeters.
 B. This drawing is subject to change without notice.
 C. Falls within JEDEC MS-026

IMPORTANT NOTICE

Texas Instruments Incorporated and its subsidiaries (TI) reserve the right to make corrections, modifications, enhancements, improvements, and other changes to its products and services at any time and to discontinue any product or service without notice. Customers should obtain the latest relevant information before placing orders and should verify that such information is current and complete. All products are sold subject to TI's terms and conditions of sale supplied at the time of order acknowledgment.

TI warrants performance of its hardware products to the specifications applicable at the time of sale in accordance with TI's standard warranty. Testing and other quality control techniques are used to the extent TI deems necessary to support this warranty. Except where mandated by government requirements, testing of all parameters of each product is not necessarily performed.

TI assumes no liability for applications assistance or customer product design. Customers are responsible for their products and applications using TI components. To minimize the risks associated with customer products and applications, customers should provide adequate design and operating safeguards.

TI does not warrant or represent that any license, either express or implied, is granted under any TI patent right, copyright, mask work right, or other TI intellectual property right relating to any combination, machine, or process in which TI products or services are used. Information published by TI regarding third-party products or services does not constitute a license from TI to use such products or services or a warranty or endorsement thereof. Use of such information may require a license from a third party under the patents or other intellectual property of the third party, or a license from TI under the patents or other intellectual property of TI.

Reproduction of information in TI data books or data sheets is permissible only if reproduction is without alteration and is accompanied by all associated warranties, conditions, limitations, and notices. Reproduction of this information with alteration is an unfair and deceptive business practice. TI is not responsible or liable for such altered documentation.

Resale of TI products or services with statements different from or beyond the parameters stated by TI for that product or service voids all express and any implied warranties for the associated TI product or service and is an unfair and deceptive business practice. TI is not responsible or liable for any such statements.

Following are URLs where you can obtain information on other Texas Instruments products and application solutions:

Products		Applications	
Amplifiers	amplifier.ti.com	Audio	www.ti.com/audio
Data Converters	dataconverter.ti.com	Automotive	www.ti.com/automotive
DSP	dsp.ti.com	Broadband	www.ti.com/broadband
Interface	interface.ti.com	Digital Control	www.ti.com/digitalcontrol
Logic	logic.ti.com	Military	www.ti.com/military
Power Mgmt	power.ti.com	Optical Networking	www.ti.com/opticalnetwork
Microcontrollers	microcontroller.ti.com	Security	www.ti.com/security
		Telephony	www.ti.com/telephony
		Video & Imaging	www.ti.com/video
		Wireless	www.ti.com/wireless

Mailing Address: Texas Instruments
Post Office Box 655303 Dallas, Texas 75265