



查询VM7208供应商

VTC Inc.  
Value the Customer™

捷多邦 专业PCB打样工厂, 24小时

VM7200 加急出货

# 2, 4, 6 OR 8-CHANNEL, 5-VOLT, THIN-FILM HEAD, READ/WRITE PREAMPLIFIER

July, 1993

## FEATURES

- High Performance
  - Read Gain = 200 V/V Typical
  - Input Noise = 0.75nV/√Hz max
  - Head Inductance Range = 0.2 - 10 μH
  - Write Current Range 10 - 40 mA
  - Input Capacitance = 23 pF max
- Very Low Power Dissipation = 7.5 mW Typical in Sleep Mode
- Power Up/Down Data Protect Circuitry
- Reduced Write-to-Read Recovery Time
- Single Power Supply = 5 V ± 10%
- Fault Detect Capability
- Designed for Thin-Film heads
- Write Unsafe Detection
- Standard Schottky - Isolated 400 Ω Damping Resistor (patent pending)
- Available in 2, 4, 6 or 8-Channel Options

## DESCRIPTION

The VM7200 is a high-performance, very low-power read/write preamplifier designed for use with external thin-film or MIG recording heads. This circuit will operate on a single 5-volt power supply and is ideally suited for use in battery powered disk drives.

The VM7200 provides write current and data protection circuitry, and low noise read functions for up to eight read/write heads. When deactivated, the device enters a *sleep mode* which reduces power dissipation to 7.5 mW. Data protection circuitry is provided to ensure that the write current source is totally disabled during power supply power up/power down conditions. Write-to-read recovery time is minimized by eliminating common mode output voltage swings when switching between modes.

The VM7200 is available in several different packages. Please consult VTC for package availability.

## CONNECTION DIAGRAMS

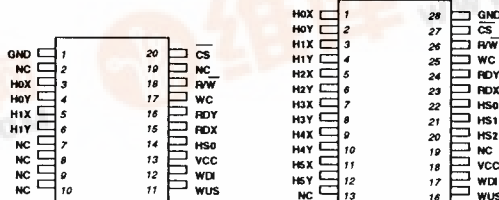

2-Channel  
20-lead SSOP

6-Channel  
28-lead SSOP

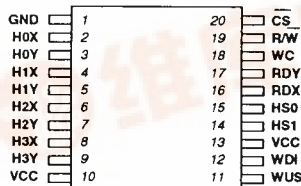

4-Channel  
20-lead SOIC, SSOP, VSOP

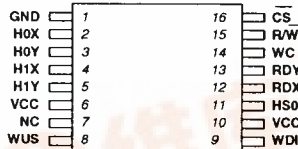

2-Channel  
16-lead SOIC

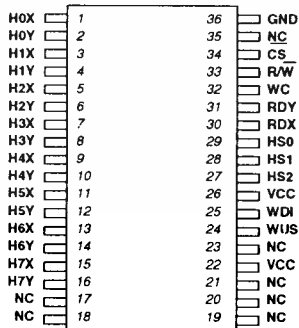

8-Channel

TWO/THREE TERMINAL  
& SERVO PREAMPLIFIERS



**BLOCK DIAGRAM**

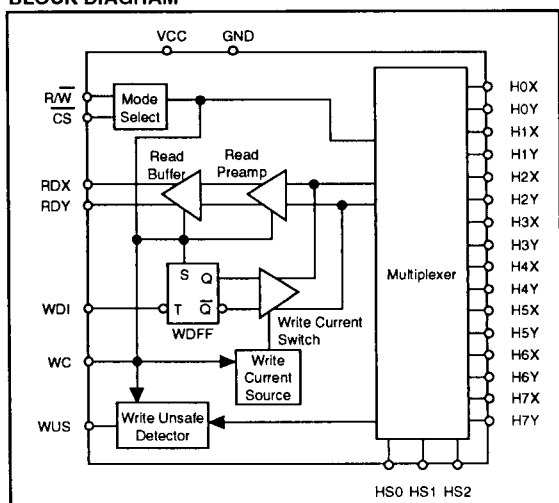

**ABSOLUTE MAXIMUM RATINGS**

Power Supply:	
V <sub>CC</sub> .....	-0.3V to +7V
Write Current I <sub>W</sub> .....	60mA
Input Voltages:	
Digital Input Voltage V <sub>IN</sub> .....	-0.3V to (V <sub>CC</sub> + 0.3)V
Head Port Voltage V <sub>H</sub> .....	-0.3V to (V <sub>CC</sub> + 0.3)V
WUS Pin Voltage Range V <sub>WUS</sub> .....	-0.3V to +6V
Output Current:	
RDX, RDY: I <sub>O</sub> .....	-10mA
WUS: I <sub>WUS</sub> .....	+12mA
Junction Temperature .....	150°C
Storage Temperature T <sub>stg</sub> .....	-65° to 150°C
Thermal Characteristics, θ <sub>JA</sub> :	
16-lead SOIC .....	100°C/W
20-lead SOIC .....	80°C/W
20-lead SSOP .....	TBD
28-lead SOIC .....	75°C/W
36-lead SOIC .....	60°C/W

**RECOMMENDED OPERATING CONDITIONS**

Power Supply Voltage:	
V <sub>CC</sub> .....	+5V ± 10%
Write current (I <sub>W</sub> ) .....	10 to 40mA
Head Inductance (L <sub>H</sub> ) .....	0.2 to 10µH
Junction Temperature (T <sub>J</sub> ) .....	25°C to 125°C

**CIRCUIT OPERATION**

The VM7200 addresses up to eight 2-terminal, thin-film recording heads, providing switched write current in the write mode, or data amplification in the read mode. Head selection and mode control is determined by the head select lines, HS0, HS1, HS2 and mode control lines, CS, R/W as shown in Tables 1 and 2. Internal resistor pullups, provided on the CS and R/W pins, are used to pull the pins to V<sub>CC</sub> when the pins are not driven.

ther control line opens up. The part's operation over a wide range of inductive loads makes it suitable for non-thin-film two-terminal heads also.

**Write Mode**

In write mode, the VM7200 acts as a write current switch with the write unsafe (WUS) detection circuitry activated. Write current is toggled between the X and Y side of the selected head on each high to low transition on the Write Data Flip-Flop (WDFFF) so that upon switching to the write mode, the write current flows into the "X" side of the head.

The write current magnitude is determined by an external resistor (R<sub>WC</sub>) connected between the WC pin and Ground. An internally generated reference voltage is present at the WC pin. The magnitude of the Write Current (0-PK, ± 8%) is:

$$I_W = K_W/R_{WC} = 50/R_{WC}$$

Power supply fault protection ensures data security on the disk by disabling the write current source during a power supply voltage fault or by supply power up/down conditions. Additionally, the write unsafe (WUS) detection circuitry will flag any of the conditions listed below, as a high level on the WUS line. Two negative transitions on the WDI pin, after the fault is corrected, is required to clear the WUS line.

- No write current
- WDI frequency too low
- Read or sleep mode

**Read Mode**

In read mode, the VM7200 acts as a low noise differential amplifier for signals coming off the disk. The write current generator and write unsafe circuitry is deactivated. The RDX, RDY pins are emitter follower outputs and are in phase with "X" and "Y" head ports. These outputs should be AC coupled to the load. The RDX, RDY common mode output voltage is constant, minimizing the transient between read and write mode, thereby, substantially reducing the recovery time in the Pulse Detector circuit connected to these outputs.

**Sleep Mode**

When CS is high, initially all circuitry is shut down so that power dissipation is reduced to 7.5 mW in the **sleep mode**. Switching the CS line low "wakes up" the chip and the device will enter the read or write mode, depending on the status of the R/W line.

**Diode Connected Damping Resistor (patent pending)**

The VM7200 has damping resistors isolated by Schottky diodes. The diodes effectively remove the resistor from the circuit during the read mode, however during the write mode with the higher level input signal, the resistor provides damping for the write current waveform.

Input Structure:

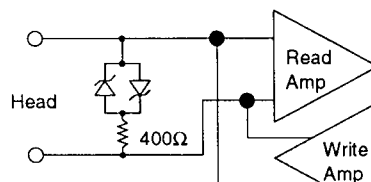

TWO/THREE TERMINAL & SERIAL PREAMPLIFIERS

# VM7200

**Table 1: Head Select**

HS2	HS1	HS0	HEAD
0	0	0	0
0	0	1	1
0	1	0	2
0	1	1	3
1	0	0	4
1	0	1	5
1	1	0	6
1	1	1	7

**Table 2: Mode Select**

$\overline{CS}$	$\overline{RW}$	MODE
0	0	Write/Awake
0	1	Read/Awake
1	X	Sleep

**PIN DESCRIPTIONS**

NAME	I/O	DESCRIPTION
HS0-HS2	I*	Head Select: selects one of up to 8 heads
H0X-H7X H0Y-H7Y	I/O	X, Y Head terminals
WDI	I*	Write Data Input: TTL input signal, negative transition toggles direction of head current
$\overline{CS}$	I	Chip select: high level signal puts chip in sleep mode, low level wakes chip up
$\overline{RW}$	I*	Read/Write select: High level selects read mode, low-level selects write mode
WUS	O*	Write unsafe: Open collector output: high level indicates writes unsafe condition
WC		Write current adjust: A resistor adjusts level of write current
RDX-RDY	O*	Read data output: differential output data
VCC		+5 volt supply**
GND		Ground

\* May be wire-OR'ed for multi-chip usage.

\*\* Although both VCC connections are recommended, only one connection is required as both are connected internally.

**DC CHARACTERISTICS** Recommended operating conditions apply unless otherwise specified.

PARAMETER	SYM	CONDITIONS	MIN	TYP (Note 1)	MAX	UNITS
Supply Current	I <sub>CC</sub>	Read Mode		33	45	mA
		Write Mode		42 + I <sub>W</sub>	50 + I <sub>W</sub>	
		Idle Mode		1.5	3	
Power Dissipation	PD	Read Mode		165	230	mW
		Write Mode, I <sub>W</sub> = 20mA		310	385	
		Idle Mode		7.5	17	
Input High Voltage	V <sub>IH</sub>		2		V <sub>CC</sub> +0.3	V
Input Low Voltage	V <sub>IL</sub>		-0.3		0.8	V
Input High Current	I <sub>IH</sub>	V <sub>IH</sub> = 2.7V			80	μA
Input Low Current	I <sub>IL</sub>	V <sub>IL</sub> = 0.4V	-160			μA
WUS Output Low Voltage	V <sub>OL</sub>	I <sub>OL</sub> = 4.0mA		0.35	0.5	V
WUS Output High Current	I <sub>OH</sub>	V <sub>OH</sub> = 5.0V		13	100	μA
VCC Value for Write Current Turn Off		I <sub>IH</sub> < 0.2mA	3.7	4.1	4.3	V

TWO THREE TERMINAL & SERVO PREAMPLIFIERS

**READ CHARACTERISTICS** Recommended operating conditions apply unless otherwise specified;  $C_L$  (RDX, RDY) < 20pF,  $R_L$  (RDX, RDY) = 1k $\Omega$ .

PARAMETER	SYM	CONDITIONS	MIN	TYP (Note 1)	MAX	UNITS
Differential Voltage Gain	$A_V$	$V_{IN} = 1mV_{rms}$ , 1MHz, note 2	167	195	233	V/V
Bandwidth	BW	-1dB $ Z_{sl}  < 5\Omega$ , $V_{IN} = 1mV_{p-p}$	25	40		MHz
		-3db $ Z_{sl}  < 5\Omega$ , $V_{IN} = 1mV_{p-p}$	35	60		
Input Noise Voltage	$e_{in}$	BW = 17MHz, $L_H = 0$ , $R_H = 0$		0.56	0.75	nV/ $\sqrt{Hz}$
Differential Input Capacitance	$C_{IN}$	$V_{IN} = 1mV_{p-p}$ , $f = 5MHz$		19	23	pF
Differential Input Resistance	$R_{IN}$	$V_{IN} = 1mV_{p-p}$ , $f = 5MHz$	380	1000		$\Omega$
Dynamic Range	DR	AC input voltage where the gain falls to 90% of the gain @ 0.2mVrms input, $f = 5MHz$	4	10		mVrms
Common Mode Rejection Ratio	CMRR	$V_{IN} = 100mV_{p-p}$ @ 5MHz	50	73		dB
Power Supply Rejection Ratio	PSRR	100mVp-p @ 5MHz on $V_{CC}$	45	70		dB
Channel Separation	CS	Unselected channels driven with 20mVp-p @ 5MHz Selected Channels $V_{IN} = 0mV_{p-p}$	45	60		dB
Output Offset Voltage	$V_{OS}$		-300	25	+300	mV
RDX,RDY Common Mode Output Voltage	$V_{OCM}$	Read Mode		$V_{CC}-2.3$		V
Read to Write Common Mode Output Voltage Difference	$\Delta V_{OCM}$		-350	120	350	mV
Single-Ended Output Resistance	$R_{SEO}$			36	50	$\Omega$
Output Current	$I_O$	AC Coupled Load, RDX to RDY	$\pm 1.5$			mA

Note 1: Typical values are given at  $V_{CC} = 5V$  and  $T_A = 25^\circ C$ .  
 Note 2:  $A_V$  is mask programmable for the VM7200L of 15 V/V.

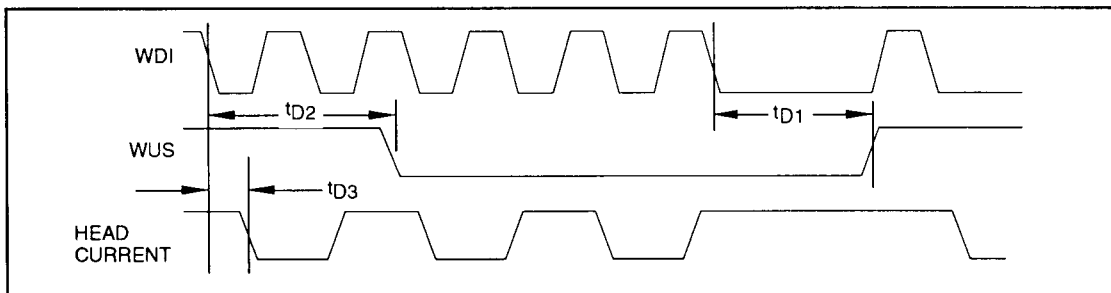

Figure 1: Write Mode Timing Diagram

TYPICAL THREE TERMINAL & SERIAL PREAMPLIFIERS

# VM7200

**WRITE CHARACTERISTICS** Recommended operating conditions apply unless otherwise specified;  $L_H = 1\mu H$ ,  $R_H = 30\Omega$ ,  $I_W = 20mA$ ,  $f_{DATA} = 5MHz$ .

PARAMETER	SYM	CONDITIONS	MIN	TYP (Note 1)	MAX	UNITS
WC Pin Voltage	$V_{WC}$			2.55		V
$I_{WC}$ to Head Current Gain	$A_I$			20		mA/mA
Write Current Constant	$K_W$	$K_W = (V_{WC})(A_I)$	46	51.5	54	V
Write Current Range	$I_W$	$1.25K < R_{WC} < 5k\Omega$	10		40	mA
Write Current Tolerance	$\Delta I_W$	$I_W$ range 10mA to 40mA	-8	+3	+8	%
Differential Head Voltage Swing	$V_{DH}$	Open Head	4	5.2		Vp-p
WDI Transition Frequency for Safe Condition	$f_{DATA}$	WUS = Low	1			MHz
Differential Output Capacitance	$C_O$	Small signal conditions			25	pF
Differential Output Resistance	$R_O$	Small signal conditions	3200			$\Omega$
Unselected Head Transient Current	$I_{UH}$	$I_W = 20mA$		0.15	1	mA(pk)
RDX, RDY Common Mode Output Voltage	$V_{CM}$			$V_{CC}-2.3$		V

Note 1: Typical values are given at  $V_{CC} = 5V$  and  $T_A = 25^\circ C$ .

**SWITCHING CHARACTERISTICS** Recommended operating conditions apply unless otherwise specified;  $I_W = 20mA$ ,  $f_{DATA} = 5MHz$ ,  $L_H = 1\mu H$ ,  $R_H = 30\Omega$ ,  $C_L$  (RDX, RDY)  $\leq 20pF$  (see figure 1).

PARAMETER	SYM	CONDITIONS	MIN	TYP (Note 1)	MAX	UNITS
$\overline{R/W}$ Read to Write Delay	$t_{RW}$	$\overline{R/W}$ to 90% $I_W$		0.1	1.0	$\mu s$
$\overline{R/W}$ Write to Read Delay	$t_{WR}$	$\overline{R/W}$ to 90% of 100mV, 10MHz read signal envelope		0.6	1.0	$\mu s$
$\overline{CS}$ Unselect to Select Delay	$t_{IR}$	$\overline{CS}$ to 90% $I_W$ or 90% of 100mV, 10MHz read signal envelope		0.27	0.6	$\mu s$
$\overline{CS}$ Select to Unselect Delay	$t_{RI}$	$\overline{CS}$ to 10% of $I_W$		0.08	0.6	$\mu s$
HS0, 1, any Head Delay	$t_{HS}$	HS0, 1 to 90% of 100mV, 10MHz read signal envelope		0.19	0.6	$\mu s$
WUS Safe to Unsafe Delay	$t_{D1}$		0.6	3.1	4.5	$\mu s$
WUS Unsafe to Safe Delay	$t_{D2}$			0.1	1.0	$\mu s$
Head Current Propagation Delay (TD3)	$t_{D3}$	$L_H = 0$ , $R_H = 0$ , from 50% points		19	30	ns
Head Current Asymmetry	ASYM	50% duty cycle on WDI, 1ns rise/fall time; $L_H = 0$ , $R_H = 0$		0.2	1	ns
Head Current Rise/Fall Time	$t_r/t_f$	10% to 90% points	$L_H = 0$ , $R_H = 0$	5	8	ns
			$L_H = 1\mu H$ , $R_H = 30$	16	24	

Note 1: Typical values are given at  $V_{CC} = 5V$  and  $T_A = 25^\circ C$ .